

Technics[®]



SL-1200GR2 / SL-1210GR2

Direct Drive Turntable System

Operating Instructions

Music is borderless and timeless, touching people's hearts across cultures and generations. Each day the discovery of a truly emotive experience from an unencountered sound awaits. Let us take you on your journey to rediscover music.

Rediscover Music™

Technics



Delivering the Ultimate Emotive Musical Experience to All

At Technics we understand that the listening experience is not purely about technology but the magical and emotional relationship between people and music.

We want people to experience music as it was originally intended and enable them to feel the emotional impact that enthuses and delights them.

Through delivering this experience we want to support the development and enjoyment of the world's many musical cultures. This is our philosophy.

With a combination of our love of music and the vast high-end audio experience of the Technics team, we stand committed to building a brand that provides the ultimate emotive musical experience by music lovers, for music lovers.

Director

Michiko Ogawa

A handwritten signature in black ink that reads "Michiko Ogawa". The signature is written in a cursive, flowing style with a long horizontal stroke extending to the right under the name.

Introduction

Thank you for purchasing this product.

Please read these instructions carefully before using this product, and save this manual for future use.

- About descriptions in these operating instructions
 - Pages to be referred to are indicated as "(⇒ 00)".
 - The illustrations shown may differ from your unit.

Sales and Support Information

Customer Communications Centre

- For customers within the UK: 0333 222 8777
- For customers within Ireland: 01 447 5229
- Monday–Friday 9:00 am – 5:00 pm, (Excluding public holidays).
- For further support on your product, please visit our website: www.technics.com/uk/

Features

Coreless direct drive motor and newly developed motor drive circuit to achieve high precision, stable rotation and high reliability

- The adoption of coreless direct drive motor and highly precise motor control technology reduces minute vibration and achieves high reliability during rotation while maintaining high torque.
- The newly developed $\Delta\Sigma$ (delta sigma) -Drive motor drive circuit technology suppresses minute vibration caused by the motor and further reduces the transmission of vibration to the stylus tip on the record.

Newly designed low-noise power supply to suppress external noise

- We have adopted the newly designed low-noise switching power supply which utilises the know-how for Technics Grand Class amplifiers/digital players and the noise removal circuit of the top-tier SL-1000R model.

The tone arm with high-precision bearings achieves high initial-motion sensitivity

- The tone arm pipe made of light, highly rigid aluminium as well as the traditional Technics gimbal suspension construction and high-precision bearings attain high initial-motion sensitivity.

A turntable with high rigidity and improved vibration damping capacity

- The reinforcing ribs on the back side of the aluminium die-cast platter and the rubber installed to suppress unnecessary resonance deliver high rigidity and improved vibration damping capacity.

Vibration-proof cabinet and insulators

- The two-layered cabinet made of a combination of BMC and aluminium die-cast ensures high rigidity, and the special silicon rubber insulators providing excellent vibration damping capacity and long-term reliability reduce external vibration and suppress howling noise.

Table of contents

● Before use

Safety precautions	06
Accessories	09
Parts Name	10

Before use

● Getting started

Putting the player together	12
● Connecting to the PHONO terminals and AC IN terminal.....	12
● Attaching the cartridge	13
● Before fitting the turntable.....	15
● Fitting the turntable	15
● Fitting the turntable mat	15
● Attaching the head shell.....	15
● Attaching the balance weight.....	15
Connections and installation	16
● Connecting to an integrated amplifier or component system.....	16
● Installation	17
● Fit the dust cover.....	17
Adjustment	18
● Horizontal balance	18
● Stylus pressure	18
● Anti-skating.....	18
● Tone arm height.....	19
● Armlift height.....	20
● Adjusting the turntable startup/brake speed	20

Getting started

● Playing back

Playing records.....	21
Pitch control (fine adjustment to pitch).....	23
Strobe light off function.....	24

Playing
back

● Maintenance

Maintenance.....	25
Troubleshooting guide	26
Specifications	27

Maintenance

Safety precautions

Warning

Unit

- To reduce the risk of fire, electric shock or product damage,
 - Do not expose this unit to rain, moisture, dripping or splashing.
 - Do not place objects filled with liquids, such as vases, on this unit.
 - Use only the recommended accessories.
 - Do not remove covers.
 - Do not repair this unit by yourself. Refer servicing to qualified service personnel.
 - Do not let metal objects fall inside this unit.
 - Do not place heavy items on this unit.

AC mains lead

- To reduce the risk of fire, electric shock or product damage,
 - Ensure that the power supply voltage corresponds to the voltage printed on this unit.
 - Insert the mains plug fully into the socket outlet.
 - Do not pull, bend, or place heavy items on the lead.
 - Do not handle the plug with wet hands.
 - Hold onto the mains plug body when disconnecting the plug.
 - Do not use a damaged mains plug or socket outlet.
- The mains plug is the disconnecting device. Install this unit so that the mains plug can be unplugged from the socket outlet immediately.
- Ensure the earth pin on the mains plug is securely connected to prevent electrical shock.
 - An apparatus with CLASS I construction shall be connected to a mains socket outlet with a protective earth connection.

Caution



Unit

- Do not place sources of naked flames, such as lighted candles, on this unit.
- This unit may receive radio interference caused by mobile telephones during use. If such interference occurs, please increase separation between this unit and the mobile telephone.
- This unit is intended for use in moderate and tropical climates.
- Do not put any objects on this unit. This unit becomes hot while it is on.

Placement

- Place this unit on an even surface.
- To reduce the risk of fire, electric shock or product damage,
 - Do not install or place this unit in a bookcase, built-in cabinet or in another confined space. Ensure this unit is well ventilated.
 - Do not obstruct this unit's ventilation openings with newspapers, tablecloths, curtains, and similar items.
 - Do not expose this unit to direct sunlight, high temperatures, high humidity, and excessive vibration.
- Ensure that the placement location is sturdy enough to accommodate the weight of this unit (⇒ 27).
- Do not lift or carry this unit by holding the knobs. Doing so may cause this unit to fall, resulting in personal injury or malfunction of this unit.
- Keep any IC card or magnetic card such as a credit card away from the turntable.
 - Otherwise the IC card or magnetic card may become unusable due to the magnetic effect.

Caution for AC Mains Lead

(For the AC mains plug of three pins)
 For your safety, please read the following text carefully.
 This appliance is supplied with a moulded three pin mains plug for your safety and convenience. A 10-ampere fuse is fitted in this plug. Should the fuse need to be replaced please ensure that the replacement fuse has a rating of 10-ampere and that it is approved by ASTA or BSI to BS1362.
 Check for the ASTA mark  or the BSI mark  on the body of the fuse.
 If the plug contains a removable fuse cover you must ensure that it is refitted when the fuse is replaced.
 If you lose the fuse cover the plug must not be used until a replacement cover is obtained. A replacement fuse cover can be purchased from your local dealer.

Before use

Remove the connector cover.

How to replace the fuse

The location of the fuse differs according to the type of AC mains plug (figures A and B). Confirm the AC mains plug fitted and follow the instructions below. Illustrations may differ from actual AC mains plug.

1. Open the fuse cover with a screwdriver.

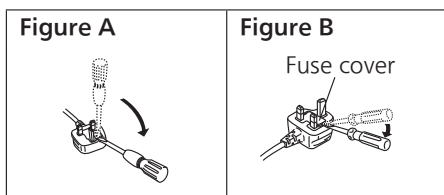

2. Replace the fuse and close or attach the fuse cover.

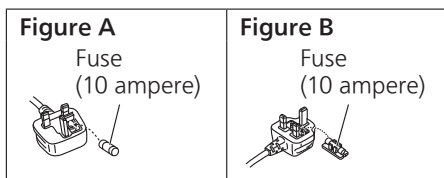

Disposal of Old Equipment

Only for European Union and countries with recycling systems



These symbols on the products, packaging, and/or accompanying documents mean that used electrical and electronic products must not be mixed with general household waste.

For proper treatment, recovery and recycling of old products, please take them to applicable collection points in accordance with your national legislation.







By disposing of them correctly, you will help to save valuable resources and prevent any potential negative effects on human health and the environment.

For more information about collection and recycling, please contact your local municipality.

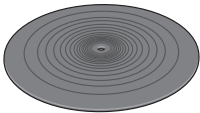
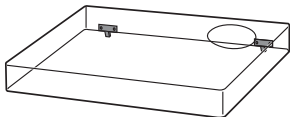
Penalties may be applicable for incorrect disposal of this waste, in accordance with national legislation.

Accessories

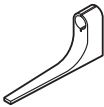
In order to prevent damage during shipping some of the equipment has been disassembled. Please check and identify the supplied accessories.

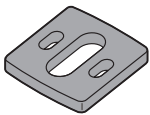
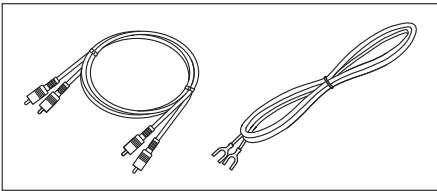
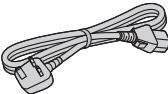
<p>Turntable (1 pc.) (TTV0137)</p> 	<p>Turntable mat (1 pc.) (RGS0008)</p> 	<p>Dust cover (1 pc.) (TTFA0457)</p> 
<p>EP record adaptor (1 pc.) SL-1200GR2: (TBMX5422) SL-1210GR2: (TBMX5421)</p> 	<p>Balance weight (1 pc.) SL-1200GR2: (TYL0752) SL-1210GR2: (TYL0295)</p> 	<p>Auxiliary weight (1 pc.) (TKKH51441)</p> 
<p>Head shell (1 pc.) (TEKL005-1)</p> 	<p>Overhang gauge (1 pc.) (RMR2210-W)</p> 	<p>Screw set for cartridge (1 set) (TTV0202)</p> <ul style="list-style-type: none"> ● Nuts (2 pc.) ● Screws-short (2 pc.) ● Screws-long (2 pc.) ● Washers (2 pc.) <p>(Supplied in a bag)</p> 
<p>Cartridge spacer (1 pc.) (TYL0753)</p> 	<p>PHONO cable (1 pc.) PHONO earth lead (1 pc.) (TAQ0036)</p> 	
<p>AC mains lead (1 pc.) (K2CT3YY00081)</p> 		

- The model numbers of the accessories are as of July 2023. They are subject to change without notice.
- Keep the packaging materials after taking out the goods. You will need them when carrying the product over long distances.
- Follow the local regulations when disposing of the product.
- Do not use any other AC mains lead, PHONO cable and PHONO earth lead except the supplied one.
- Keep the cartridge, auxiliary weight, nuts, screws, washers and cartridge spacer out of reach of children to prevent swallowing.
- Illustrations and figures in this manual are of the silver main body.

Parts Name

Numbers such as (⇒ 00) indicate reference pages.

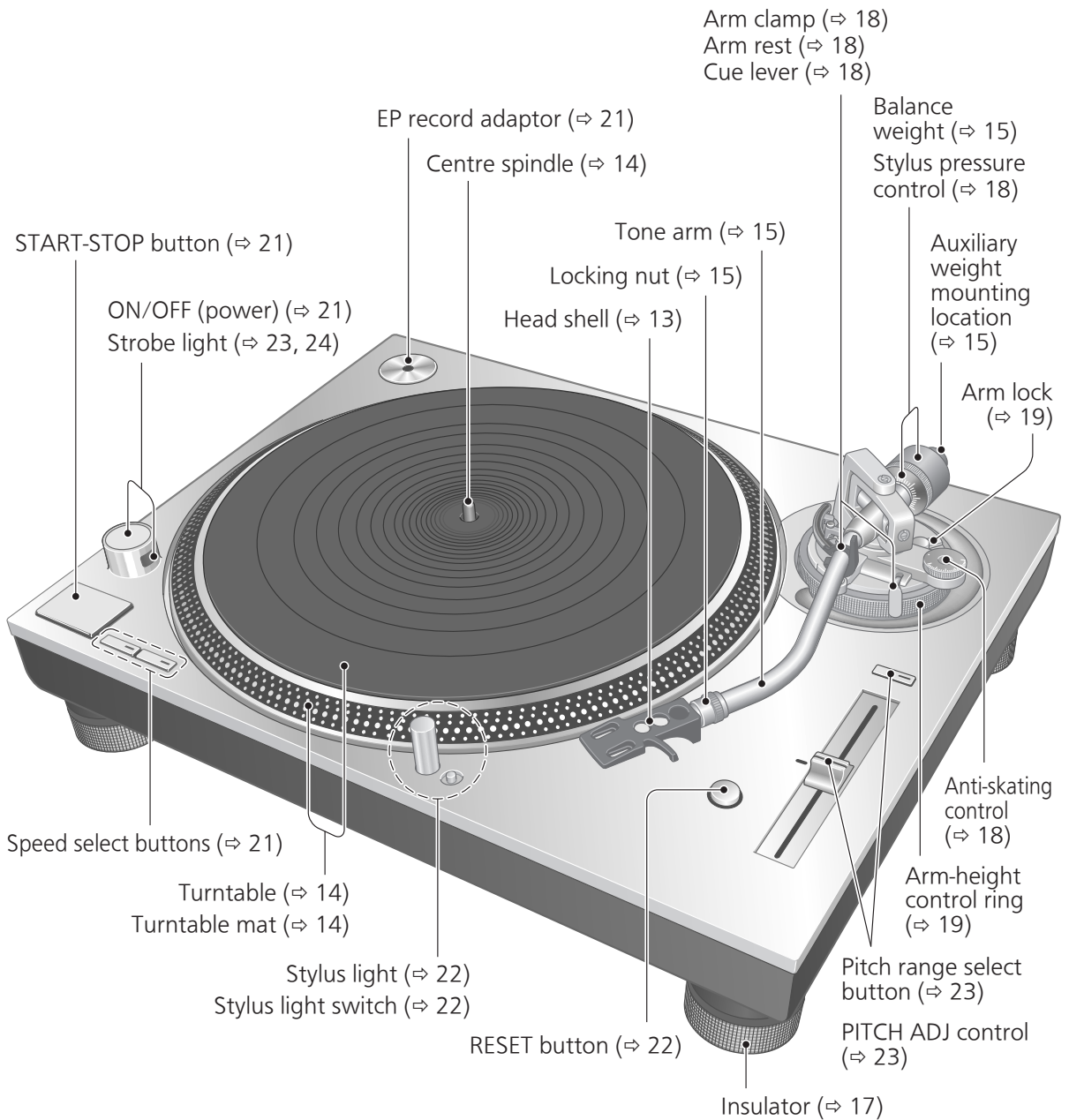

Back

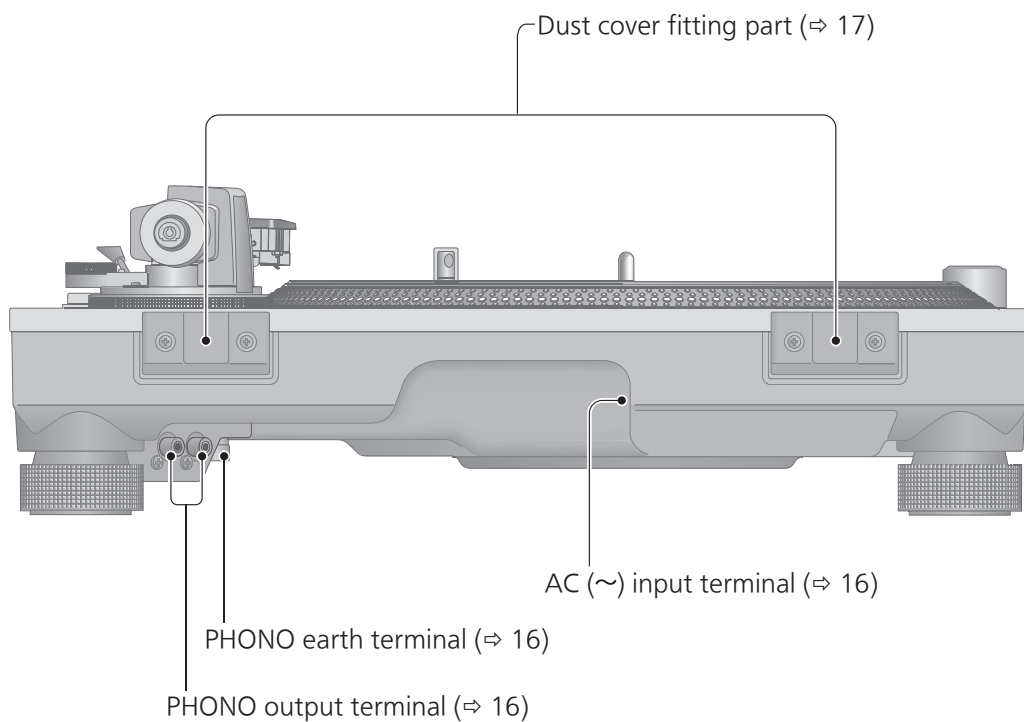

Putting the player together

Connecting to the PHONO terminals and AC IN terminal

Make connection to the PHONO terminals and AC IN terminal before setting up or installing the player.

Attention

Be careful not to tip over the player.

1 Take out the player from the package, and rest the player in the assembled cardboard box so that you can make connection to the PHONO terminals and AC IN terminal on the back side.

① Take out the pad in the bottom.

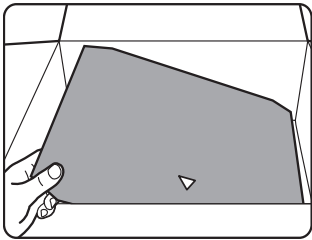

② Fold the pad along the creases on the back side.

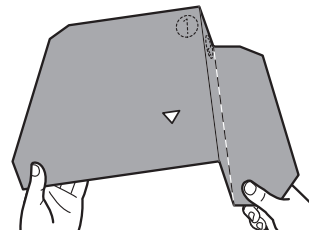
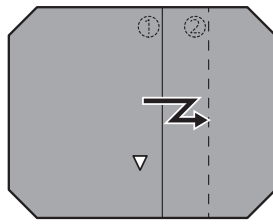

③ Put the pad into cardboard box.

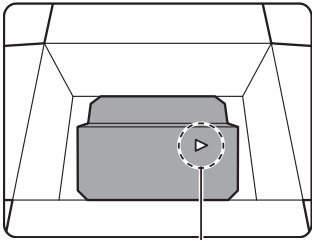

Point the vertex of ▽ at the short side of the cardboard box.

④ Fold the front flap inside.

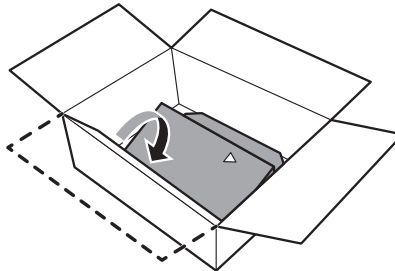

⑤ Rest the player in the box.

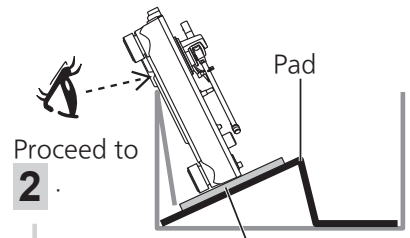

Proceed to **2**.

To avoid damaging the player, cover the player contact area with a soft cloth or a protection sheet wrapping the player.

2 Connect the supplied PHONO cable, PHONO earth lead, and AC mains lead.

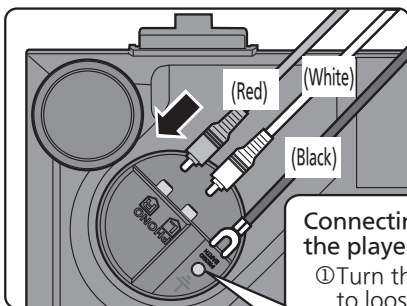

Connecting the PHONO earth lead to the player and amplifier.

- ① Turn the terminal to the left to loosen.
- ② Insert the earth lug and tighten the terminal securely.

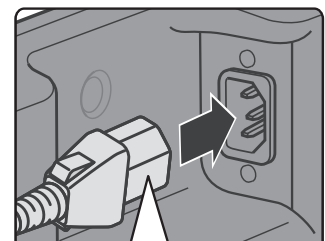
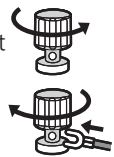

Insert the AC mains lead up to a point just before the round hole.

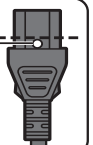

Attaching the cartridge

1 Attach a cartridge (store-bought) tentatively.

Follow the cartridge's instructions to correctly attach it to the head shell, and tighten the screws lightly.

- If the mounting screws are included in the cartridge, use them.
- When playing SP records, use a cartridge for SP records.
- Use a commercially available mini flat screwdriver (4 mm).
- Be careful not to touch the stylus tip.

(Lead wire)	(Terminal)	(Lead wire)	(Terminal)
Red	→ R+ (Red)	White	→ L+ (White)
Green	→ R- (Green)	Blue	→ L- (Blue)

Cartridge spacer unused

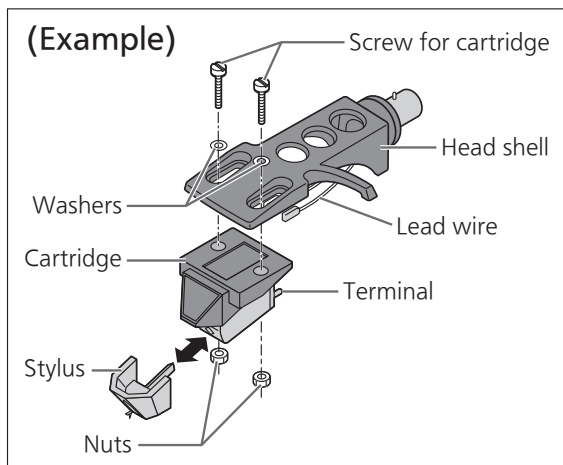

Cartridge spacer used

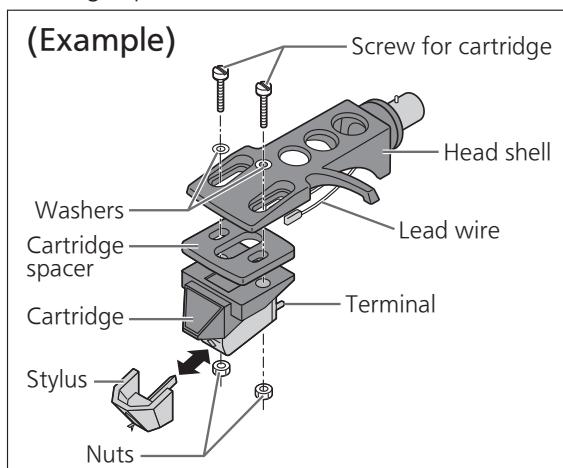

2 Adjust the overhang.

Use the included overhang gauge.

① Fit the overhang gauge to the head shell.

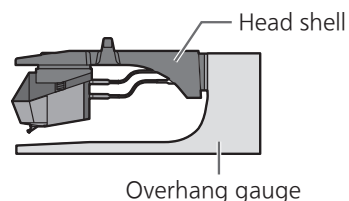

② Move the cartridge to line the stylus tip up with the end of the gauge.

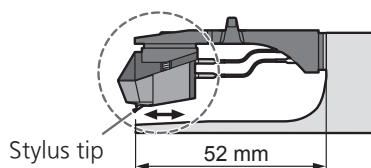

- The cartridge should be parallel on the shell head when viewed from the top and side (the illustration is the top view).

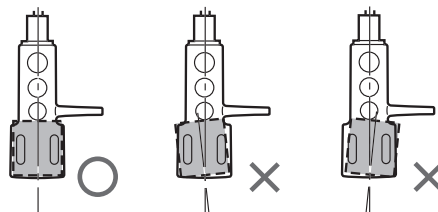

③ Tighten the screw for cartridge.

- Be careful not to allow the cartridge to slip out of place.

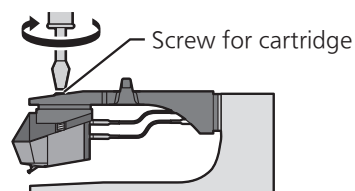

The overhang can be adjusted optimally.

* Decide whether to use a cartridge spacer, following the cartridge height table on page 19.

Putting the player together (continued)

In order to prevent damage during shipping, some of the equipment has been disassembled. Put the player together in the following order.

Attention

- Do not connect the AC mains lead until set up is complete.
- When fitting the turntable, prevent foreign material from getting in between the main unit and turntable.
- Do not touch or scratch the board.

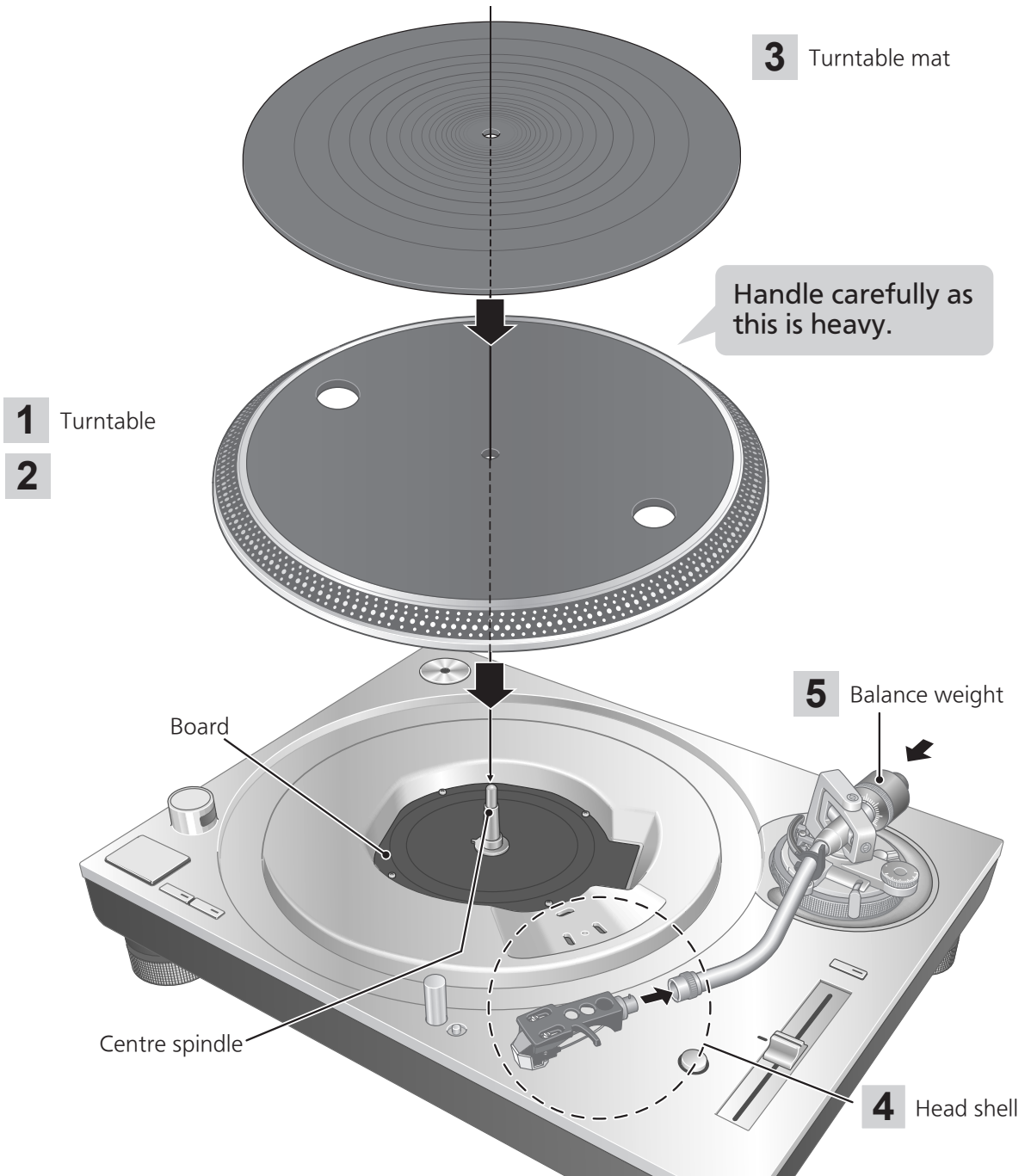

Before fitting the turntable

1 Remove the magnet cover from the turntable.

- There is a magnet and its cover on the back side of the turntable. Remove the magnet cover before fitting to the main unit.

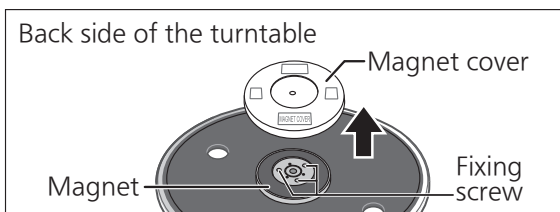

Attention

- Keep any magnetic-sensitive object such as a magnetic card and watch away from the magnet.
- Prevent the turntable from hitting the main unit or falling off. Prevent dust or iron powder from adhering to the magnet on the back side.
- Do not touch the fixing screws (three locations) of the turntable. The rating performance cannot be guaranteed if they are out of position.

Fitting the turntable

2 Slowly set the turntable on the centre spindle.

■ To remove the turntable

- ① As shown in the figure on the right, set your fingers in the two holes on the turntable, hold the centre spindle down and remove the turntable upward.

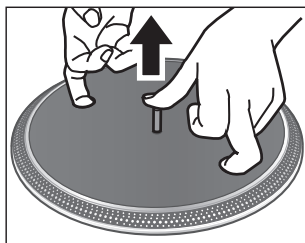

Attention

- Be careful when handling the turntable, as it is heavy.
- Keep your fingers from being caught.
- Wipe off fingerprints or dirt with a soft cloth.

Fitting the turntable mat

3 Lay the turntable mat on the turntable.

Attaching the head shell

4 Fit the head shell with the cartridge into the tone arm. Keep the head shell horizontal and tighten the locking nut.

- Be careful not to touch the stylus tip.

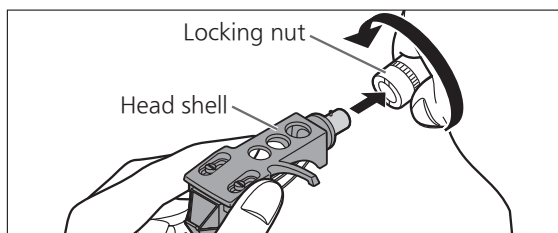

Attaching the balance weight

5 Attach the balance weight to the rear of the tone arm.

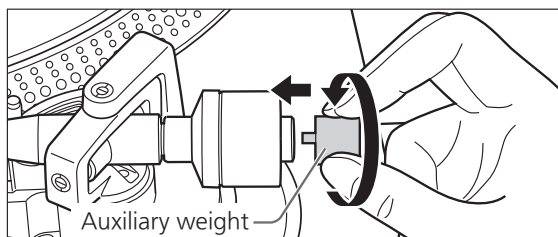
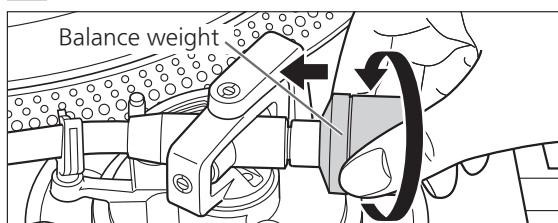

- Attach the included auxiliary weight to the rear of the tone arm according to the weight of your cartridge. For adjustable cartridge weight ranges, see "Applicable cartridge weight range". (⇒27)

Note

- The inside of the balance weight is greased.

Connections and installation

- Turn off all units and disconnect the AC mains lead from the socket before making any connections.
- Connect the AC mains lead only after all other connections are completed.
- Be sure to connect the PHONO earth lead. Otherwise mains hum may occur.
- Refer also to the instruction manual of the connected device.

1 Connect the PHONO cable and PHONO earth lead to the PHONO input terminals of the connected equipment.

- You will not have adequate volume or sound quality if the connected amplifier has no PHONO input terminals.

2 Connect the AC mains lead.

- Confirm the wattage of the AC outlet on the connected equipment before using it for this unit.
(This unit consumes 11 W.)

Connecting to an integrated amplifier or component system

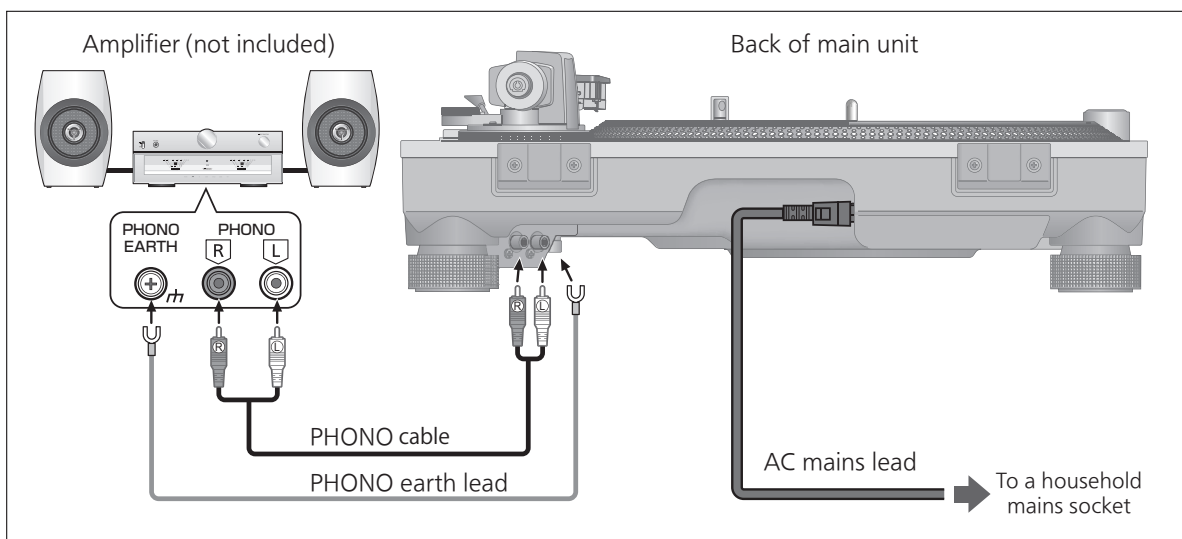

Note

- The operation switch does not separate entire unit from mains even if in "OFF" position. Remove the plug from the mains socket if you will not be using the unit for an extended period of time. Place the unit so that the plug can be easily removed.

Installation

Install the unit on a horizontal surface protected from vibrations.
Keep this unit as far as possible from speakers.

■ Adjusting the height to make the unit horizontal

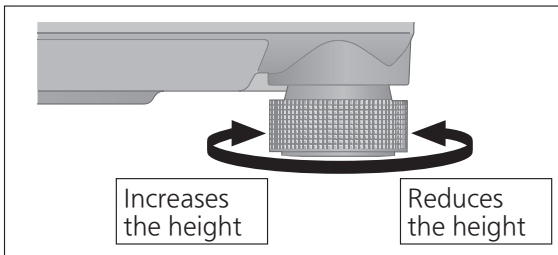

Raise the main unit to turn the insulators and adjust the height.

- **Clockwise:** Reduces the height.
- **Anti-clockwise:** Increases the height.

Attention

- Do not turn the insulators too far. Doing so may cause them to come off or damage them.

Fit the dust cover

- 1** Hold the dust cover with both hands and insert it into the dust cover fitting parts (⇒ 11) on the player.

- To remove the dust cover, keep it open and lift it straight above.

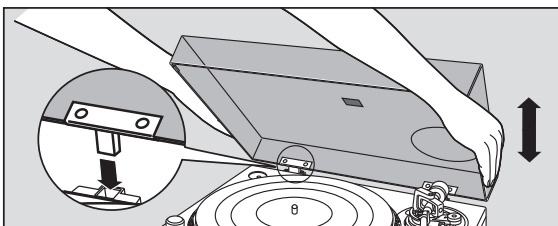

Attention

- Return the tone arm to the arm rest and fix it with the arm clamp before you attach or detach the dust cover.
- When inserting the dust cover, prevent the tip of the hinges from hitting and damaging the main unit.

■ Notes for installation

- Before you move the unit, remove all devices connected and turn off the power supply.
- Ensure the unit is not exposed to direct sunlight, dust, humidity, and heat from a heating appliance.
- This unit may pick up interference from a radio if there is one nearby. Keep the unit as far as possible from a radio.
- Do not install the unit on a heat source.
- Avoid a place with large temperature variations.
- Avoid a place with frequent condensation.
- Avoid an unstable place.
- Do not put an object on the unit.
- Do not install the unit in a confined space such as a book shelf.
- Install the unit at a position well away from walls or other devices to ensure effective heat radiation from the inside of the unit.
- Make sure that the material of the installation location is sufficiently strong to withstand the weight of this unit.
- Note that the unit may be damaged by cigarette smoke or moisture from an ultrasonic humidifier.

■ Condensation

Think of taking out a cold bottle from a refrigerator. If you leave it in a room for a while, dewdrops will form on the bottle surface. This phenomenon is called "condensation".

- Conditions causing condensation
 - ◇ Rapid temperature change (caused by moving from a warm place to a cold place or vice versa, rapid cooling or heating, or direct exposure to cooled air)
 - ◇ High humidity in a room with much steam, etc.
 - ◇ Rainy season
- Condensation may damage the unit. If it has occurred, turn the unit off and leave it until it adapts to the ambient temperature (approximately 2 to 3 hours).

Adjustment

Horizontal balance

Preparation

- First, remove the dust cover.
- Remove the stylus cover, taking care not to damage the stylus, then release the arm clamp.
- Lower the cue lever.
- Turn the anti-skating control to "0".

1 Free the tone arm from the arm rest and adjust horizontal balance by turning the balance weight.

Hold the tone arm and turn the balance weight in the arrow direction to adjust the balance until the arm is approximately horizontal.

- Take care not to allow the stylus tip to touch the turntable or main unit.

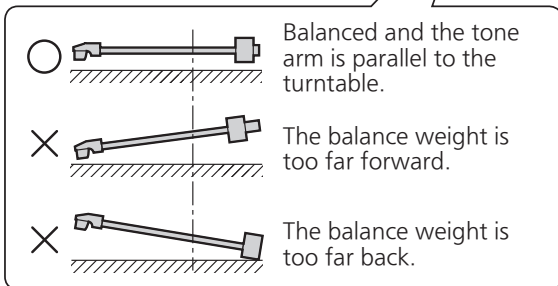
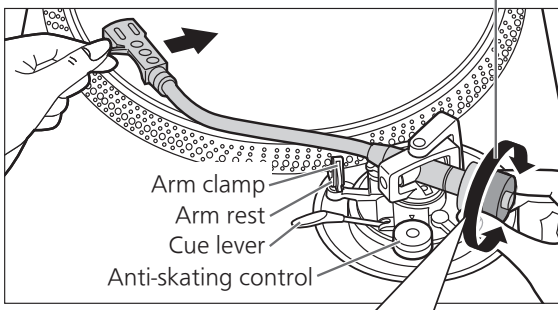
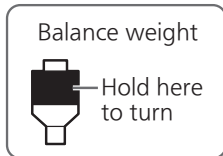

Stylus pressure

Preparation

- First, remove the dust cover.
- Return the tone arm to the arm rest and fix it with the arm clamp.

1 Turn the stylus pressure control until "0" comes to the centre line of the rear of the tone arm.

- Hold the balance weight still while doing this.

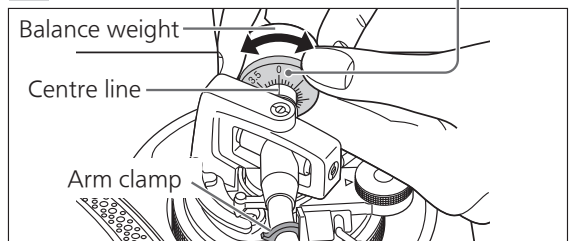
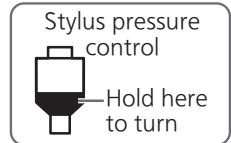

Note

- Refer to the user's guide for your stylus for the appropriate stylus pressure.

2 Turn the balance weight to adjust to the appropriate stylus pressure for the cartridge.

- The stylus pressure control will turn together with the balance weight.
- Turn until the centre line points to the appropriate stylus pressure.

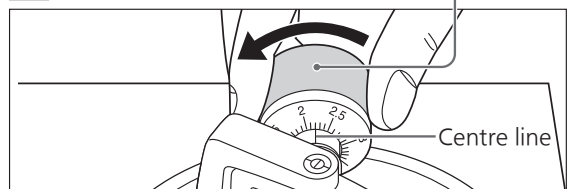
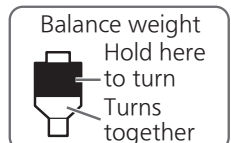

Anti-skating

1 Turn the anti-skating control to adjust it to the same value as the stylus pressure control.

Note

- For stylus pressures 3 g and above, adjust anti-skating control to "3".

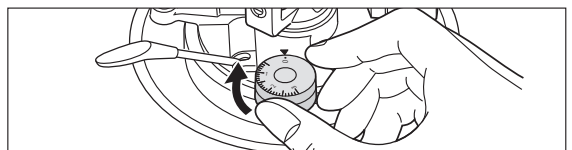

Tone arm height

Make this adjustment only if the cartridge you are using makes it necessary.

Preparation

- Put a record on the turntable.

1 Release the arm lock.

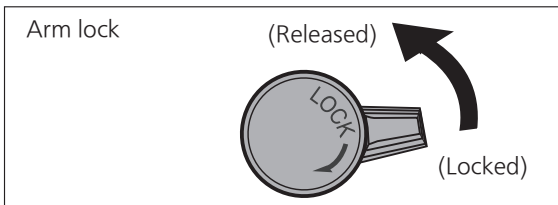

2 Adjust the height with the arm-height control ring.

Adjust the arm height until the tone arm becomes parallel to the record.

- ① Use the chart below as reference to find the appropriate position mark for the height of your cartridge.

(For supplied head shell)

Cartridge height (H) in millimeters	Cartridge height (H) in millimeters (Supplied spacer used)	Height control position
17	14	0
18	15	1
19	16	2
20		3
21		4
22		5
23		6

- ② Turn the arm-height control ring to align the position mark with the index line. 0 to 6 mm are marked on the arm height control ring.

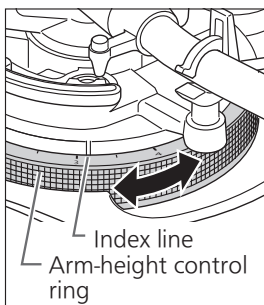

3 After arm height adjustment is finished, lock the tone arm by turning the arm lock knob.

- Be sure to turn the arm lock knob to the end as shown in the figure below. You may need to apply some force to do so.

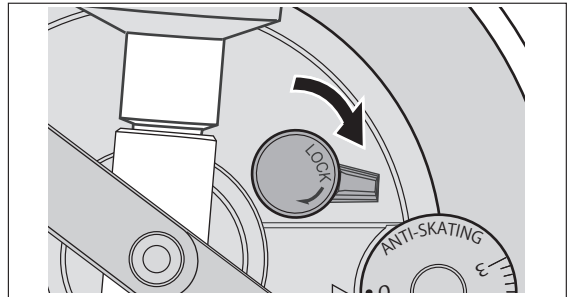

■ When you don't know the cartridge height (H) or when you don't use the supplied head shell

Remove the stylus cover, taking care not to damage the stylus, then release the arm clamp. Lower the cue lever, rest the stylus on the record and adjust the height control until the tone arm and record are parallel.

- If the cartridge height (H) is too small to make them parallel to each other, add a supplied or a commercial cartridge spacer.

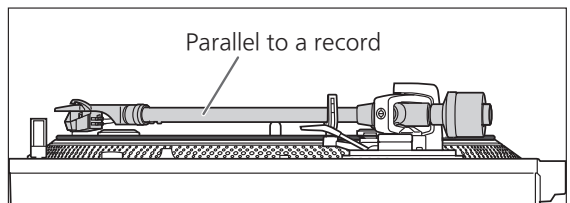

Attention

- Be careful not to damage the stylus tip.
- Do not use the product with the arm lock released.
- For finer adjustment, use a level (not included) to adjust the arm height so that the cartridge becomes parallel to a record.

Adjustment (continued)

Armlift height

Make an adjustment according to your cartridge if necessary.

Preparation

- Put a record on the turntable.
- Remove the stylus cover, taking care not to damage the stylus, then release the arm clamp.
- Lift the cue lever and move the tone arm over the record.

1 Check the armlift height (distance between the stylus tip and record surface).

If adjustment is needed, go to step **2**.

- The armlift height is factory-adjusted to 8 to 13 mm.

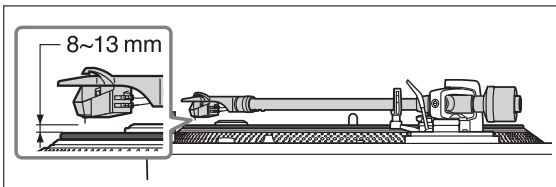

2 Return the tone arm to the arm rest, clamp it with the arm clamp and while pressing the armlift down with your finger, turn the screw to adjust the height.

- Turning the screw clockwise lowers the armlift.
- Turning the screw anti-clockwise raises the armlift.

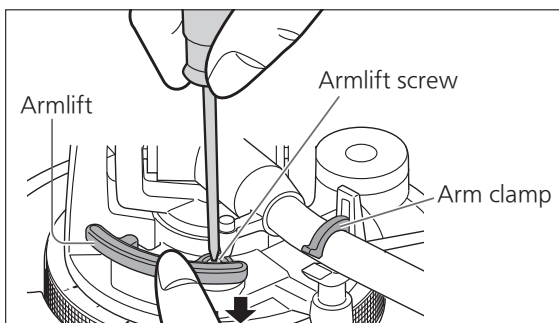

Adjusting the turntable startup/brake speed

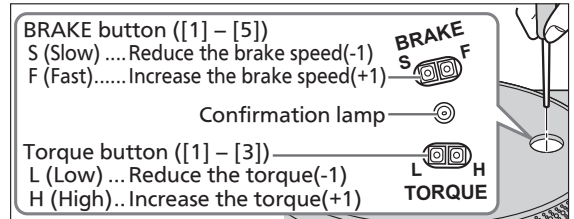

- Press the centre of the button lightly.

Startup speed

You can select from three time options for the turntable to reach constant speed after [START-STOP] is pressed.

Press the H button to increase the torque (the power required to rotate) and shorten the time to stabilise rotation. (The factory setting is [3]: highest.)

- ① The confirmation lamp blinks the specified number of times according to the current setting when you press the H or L torque button.

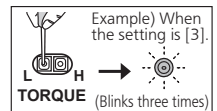

- ② To change the setting, press the H or L torque button while the lamp is lit for two seconds.

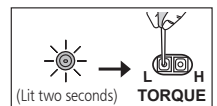

- ③ After you press the torque button, the confirmation lamp blinks the specified number of times showing the new setting, stays lit for two seconds and then goes off.

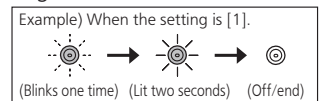

Brake speed

You can select from five time options for the turntable to stop after [START-STOP] is pressed. (You can change the brake power.) (The factory setting is [5]: fastest.)

- ① The confirmation lamp blinks the specified number of times according to the current setting when you press the F or S brake button.

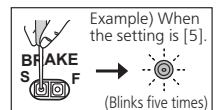

- ② To change the setting, press the F or S brake button while the lamp is lit for two seconds.

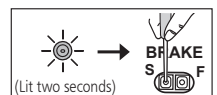

- ③ After you press the brake button, the confirmation lamp blinks the specified number of times showing the new setting, stays lit for two seconds and then goes off.

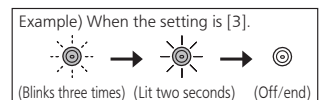

Playing records

Preparation

- ★1 Put a record (not included) on the turntable.
- ★2 Take off the stylus cover and release the arm clamp.

1 Turn [ON/OFF] to turn the unit on.

The strobe light comes on. 33-1/3 rpm is automatically selected and the indicator [33] lights.

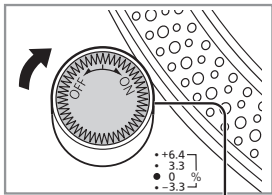

Strobe light

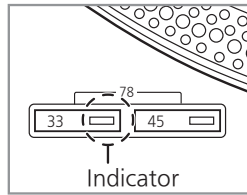

2 Press [START-STOP].

The turntable starts revolving.

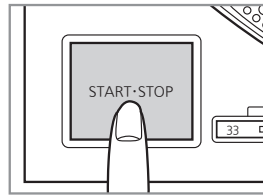

Attention

Do not press [START-STOP] when the turntable is removed.

If you have accidentally pressed [START-STOP].

- The indicator of the speed select button ([33] or [45]) starts blinking.

⇒ If it is blinking, turn [ON/OFF] to turn the unit off, fit the turntable and then turn [ON/OFF] to turn the unit on.

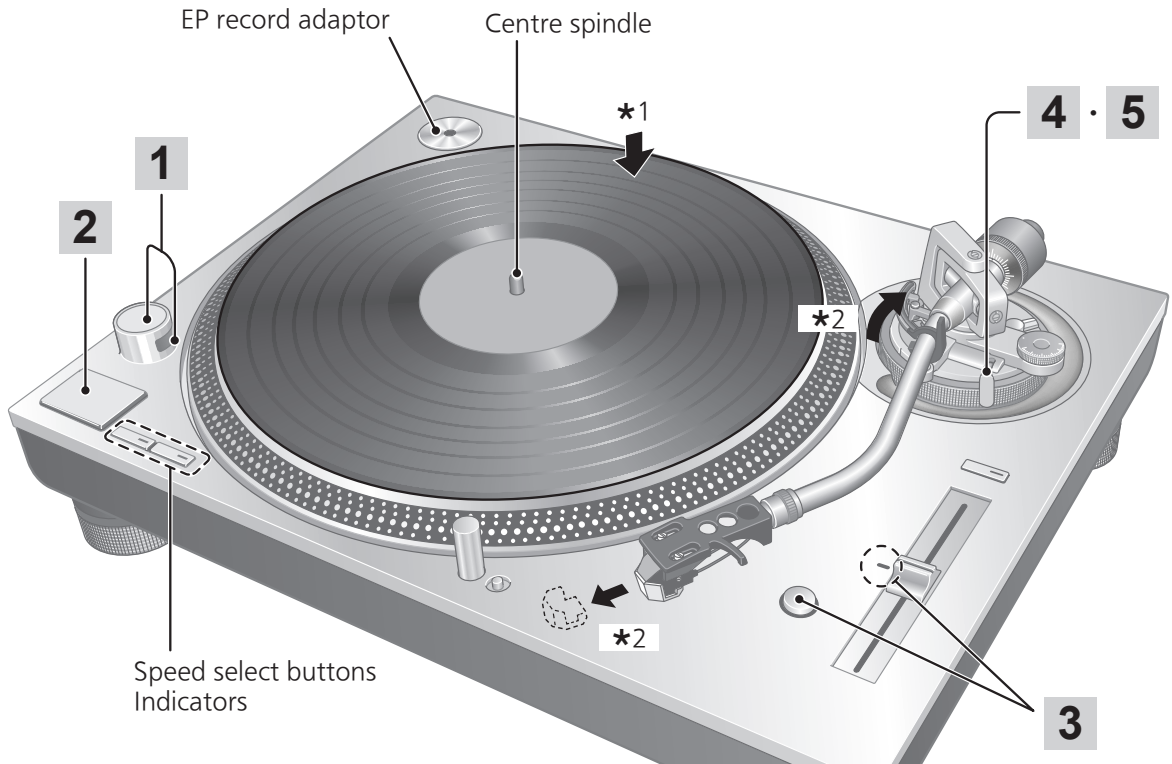

Playing records (continued)

3 Press [RESET] to light the pitch control blue LED lamp.

The unit plays at a preset pitch (33-1/3, 45 or 78 rpm) regardless of the [PITCH ADJ] position.

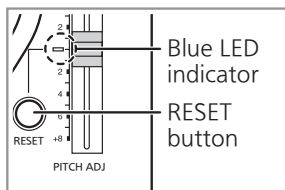

- Fine adjustment to pitch (⇒ 23)

4 Lift the cue lever and move the tone arm over the record.

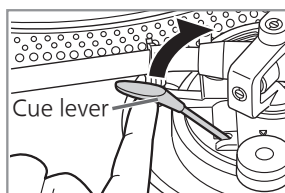

5 Lower the cue lever slowly.

The tone arm moves down slowly.

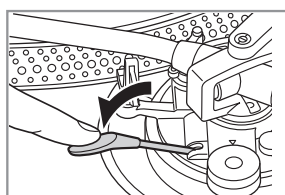

Play starts.

■ To temporarily stop play

Lift the cue lever.

- The stylus lifts off the record.
- To start play again, lower the cue lever.

■ When play finishes

- ① Lift the cue lever, return the tone arm to the arm rest and lower the cue lever.
- ② Press [START-STOP].
The electronic brake gently stops the turntable.
- ③ Turn [ON/OFF] to turn the unit off.
- ④ Clamp the tone arm with the arm clamp.
- ⑤ Put the stylus cover back on (to protect the stylus tip).

■ To light up the stylus

The stylus tip is illuminated during play.

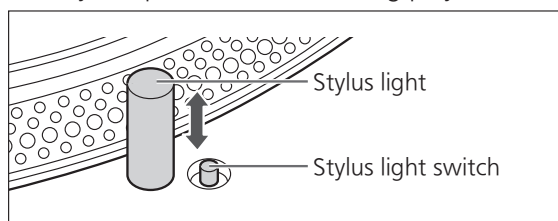

Press the stylus light switch.

- The stylus light (white LED) rises up and illuminates the stylus.
- Press down the stylus light to turn off the light.

Attention

Press the stylus light switch firmly. If the switch is lightly pressed, the light may come on but not rise up.

■ When playing EP records

- Press the speed select button [45] ([45] lights).
- Fit the EP record adaptor over the centre spindle.

■ When playing SP records

- Press the speed select buttons [33] and [45] at the same time (78 rpm: [33] and [45] light).

■ When using a record stabilizer (not included)

- See the instruction manual of the record stabilizer.
- Maximum weight: 1 kg

Pitch control (fine adjustment to pitch)

1 Press [RESET] to turn off the blue LED light.

2 Press the pitch range select button to select the pitch range.

- [x2] light on: $\pm 16\%$
- [x2] light off: $\pm 8\%$

3 While the turntable is revolving

Slide [PITCH ADJ].

- Pitch can be adjusted between approx. -8% and $+8\%$ or approx. -16% and $+16\%$ according to your selection.
- The numbers represent approximate percentages for your adjustment.

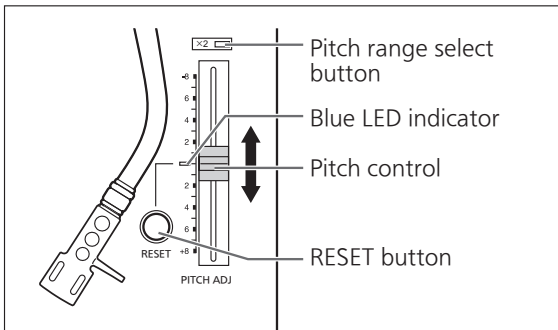

■ To measure pitch

The four rows of strobe mirrors around the edge of the turntable can assist you in measuring pitch.

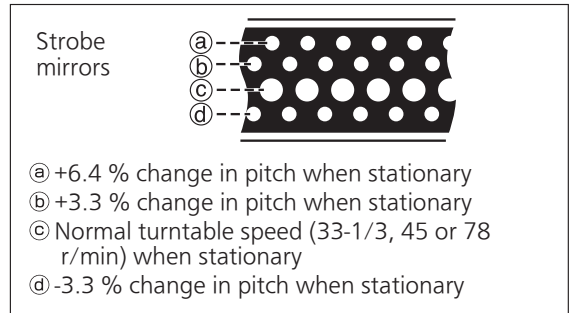

Attention

The strobe mirrors are lit by the strobe light (blue LED) synchronizing with the precise frequency of digital control.

Always use the blue LED to measure the pitch.

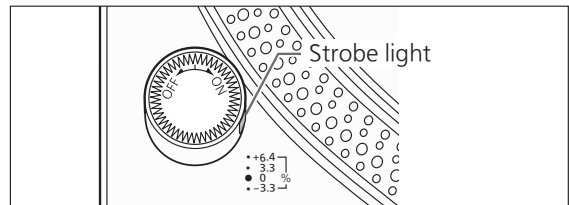

■ To reset pitch to the preset value

Press [RESET].

The blue LED indicator lights and the pitch immediately returns to a preset value regardless of the [PITCH ADJ] position.

($33\frac{1}{3}$, 45 or 78 rpm)

- Blue LED on: Fixed to the preset value.
- Blue LED off: Can be adjusted with [PITCH ADJ].

Strobe light off function

This unit is equipped with a function to turn off the strobe light while playing a record at a constant speed or stopped. The strobe light off function is "Disabled" by factory setting. That is, the strobe light will always be lit while the unit is turned on.

■ To "Enable" / "Disable" the strobe light off function

- ① Turn [ON/OFF (power)] to turn the unit on.
- ② With the turntable stopped, long press (approx. three seconds) the pitch range select button.
 - The function toggles between "Enabled" and "Disabled" each time the button is long pressed.
- ③ Check the strobe light.
 - "Enabled": The strobe light turns off.
 - "Disabled": The strobe light lights up.
 - The setting cannot be changed while the turntable is rotating.
 - The setting is remembered. The next time the power is turned on, the setting when the power was last turned off applies.

■ Operation of the strobe light off function

- The operation of the strobe light off function when it is "Enabled" is as follows:
 - The strobe light comes on after the turntable starts rotating and remains lit until the turntable reaches constant speed.
 - The strobe light turns off when the rotation is stable for a while after reaching constant speed.
 - The strobe light comes on if the rotation speed temporarily deviates from the constant speed due to an external load and the like.
 - The strobe light turns off when the rotation speed stabilizes.
- When the strobe light off function is "Disabled", the strobe light is always lit while the unit is turned on.

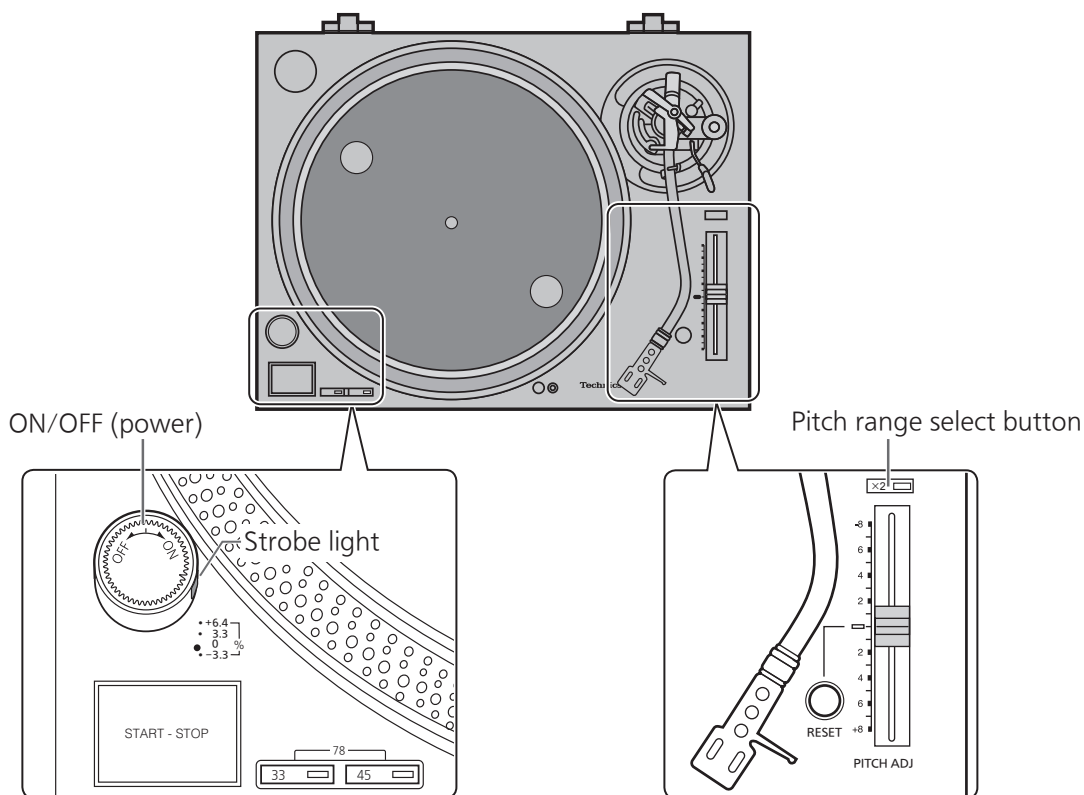

Maintenance

■ Care of the parts

Thoroughly clean dust off the stylus and record.

- Take off the head shell with the cartridge and clean the stylus using a soft brush. Brush from the base to the tip.
- Use a record cleaner to keep your records clean.

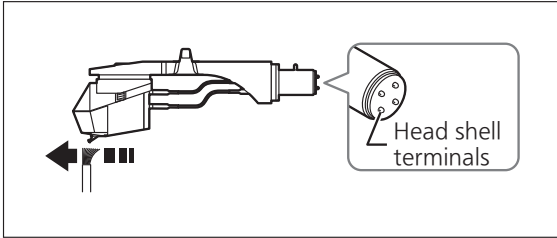

Wipe the head shell terminals occasionally. Wipe the head shell terminals with a soft cloth and fit the head shell to the tone arm.

Turn the amplifier volume down or turn the amplifier off before fitting or removing the head shell.

Damage to your speakers can occur if the head shell is moved while the volume is turned up.

■ Cleaning the dust cover and cabinet

Wipe the dust cover and cabinet with a soft cloth.

Do not touch the board while cleaning. Otherwise, the player may fail.

When dirt is heavy, wring a wet cloth tightly to wipe the dirt, and then wipe it with a soft cloth.

- Do not use solvents including benzene, thinner, alcohol, kitchen detergent, a chemical wiper, etc. This might cause the exterior case to be deformed or the coating to come off.
- Do not wipe the dust cover while playing a record. This can cause static electricity. This static can cause the tone arm to be attracted towards the dust cover.

■ Moving the unit

Repackage the unit in the packaging it came in.

Keep the packaging materials without taking them to pieces after taking out the goods. If you no longer have the packaging, do the following:

- Take off the turntable and turntable mat and carefully wrap them.
- Remove the head shell and balance weight from the tone arm and carefully wrap them.
- Clamp the tone arm with the arm clamp and tape it in place.
- Carefully wrap the main unit in a blanket or paper.

Repackaging

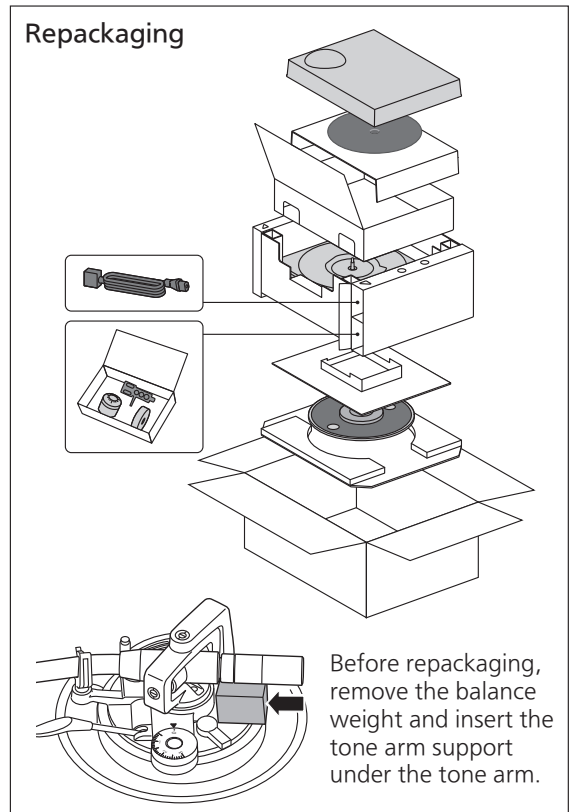

■ WEEE symbol

Disposal of the product outside the EU countries



This symbol is valid within the EU only.

Contact a local governmental office or your dealer to confirm a right manner of disposal.

Troubleshooting guide

Before requesting service, make the below checks. If you are in doubt about some of the check points, or if the remedies indicated in the chart do not solve the problem, contact your dealer.

No power.

- Is the AC mains lead plugged in?
→ Plug the mains lead in firmly. (⇒ 16)

There is power but no sound. Sound is weak.

- Are connections to the amplifier/receiver's PHONO terminals correct?
→ Connect the PHONO cables to the amplifier's PHONO input terminals. (⇒ 16)

Left and right sounds are reversed.

- Are the stereo connection cable connections to the amplifier or receiver reversed?
→ Double check all connections. (⇒ 16)
- Are connections of the head shell's lead wires to the cartridge terminals correct?
→ Double check all connections. (⇒ 13)

Humming is heard during play.

- Are there other appliances or their AC mains lead near the stereo connection cable?
→ Separate the appliances and their AC mains lead from this unit.
- Is the earth lead connected?
→ Make sure the earth lead is correctly connected. (⇒ 16)

The Strobe light or the blue indicator blinks.

Perform the following operation when the strobe light or the blue indicator blinks.
The symptom may be improved.

- ① Turn [ON/OFF] to OFF.
 - ② Pull out the power plug, wait for three seconds, and then insert the plug again.
 - ③ Turn [ON/OFF] to ON and press [START-STOP] to rotate the turntable.
- If the strobe light or the blue indicator blinks again, check which one is blinking and contact our service representative.

Specifications

General	
Power supply	AC 220 - 240 V, 50/60 Hz
Power consumption	11 W (ON) 0.3 W (OFF)
Dimensions (W×H×D)	453 x 173 x 372 mm
Weight	Approx. 11.5 kg
Operating temperature range	0 °C to 40 °C
Operating humidity range	35 % to 80 % RH (no condensation)
Turntable section	
Type	Direct drive manual turntable
Drive method	Direct drive
Motor	Brushless DC motor
Turntable	Aluminium diecast Diameter: 332 mm Weight: Approx. 2.5 kg (including a rubber sheet)
Turntable speeds	33-1/3, 45 and 78 rpm
Pitch adjustment range	±8 % and ±16 %
Starting torque	2.2 kg-cm
Build-up characteristics	0.7 s. from standstill to 33-1/3 rpm
Braking system	Electronic brake
Wow and flutter	0.025 % W.R.M.S.

Tone arm section	
Type	Static Balance
Effective length	230 mm
Overhang	15 mm
Tracking error angle	Within 2° 32' (at the outer groove of 30 cm (12") record) Within 0° 32' (at the inner groove of 30 cm (12") record)
Offset angle	22°
Arm-height adjustment range	0 – 6 mm
Stylus pressure adjustment range	0 – 4 g (direct reading)
Head shell weight	Approx. 7.6 g
Applicable cartridge weight range	(Without auxiliary weight) 5.6 to 12.0 g 3.1 to 9.5 g (using cartridge spacer) 14.3 to 20.7 g (including head shell) (With auxiliary weight) 10.0 to 16.4 g 7.5 to 13.9 g (using cartridge spacer) 18.7 to 25.1 g (including head shell)
Cartridge Mounting Dimension	12.7 mm (1/2") interval
Head shell terminal lug	1.2 mm ϕ 4-pin terminal lug

Specifications are subject to change without notice.

Headquarter Address : Panasonic Corporation
1006 Oaza Kadoma, Kadoma City, Osaka 571-8501, Japan

Importer for UK : Panasonic UK, a branch of
Panasonic Marketing Europe GmbH
Maxis 2, Western Road, Bracknell, Berkshire, RG12 1RT

Authorized Representative in Europe : Panasonic Marketing Europe GmbH
Panasonic Testing Centre
Winsbergring 15, 22525 Hamburg, Germany

**UK
CA**

Panasonic Corporation
Web Site: <http://www.panasonic.com>

