

R1080BT

Multimedia Speaker

Important safety instruction

1. Please read the instructions carefully. Keep it in safe place for future reference.
2. Use only accessories approved by the manufacturer.
3. Install the instrument properly by following the instructions in the device connection section.
4. Using the product in a 0-35°C environment is recommended.
5. To reduce the risk of fire and electric shock, do not expose the product to rain or moisture.
6. Do not use this product near water. Do not immerge the product into any liquid or have it exposed to dripping or splashing.
7. Do not install or use this product near any heat source (e.g. radiator, heater, stove, or other devices that generate heat).
8. Do not place any object filled with liquids, such as vases on the product; neither should any open fire, such as lighted candles be placed on the product.
9. Do not block any ventilation openings. Do not insert any object into ventilation openings or slots. It may cause fire or electric shock.
10. Keep sufficient clearance around the product to maintain good ventilation (minimum 5cm is recommended).
11. Do not force a plug into the jack. Before connection, check for blockage in the jack and whether the plug matches the jack and is oriented to the right direction.
12. Keep the provided accessories and parts (such as screws) away from children to prevent from being swallowed by mistake.
13. Do not open or remove the housing yourself. It may expose you to dangerous voltage or other hazardous risks. Regardless the cause of damage (such as damaged wire or plug, exposure to liquid splash or foreign object falling in, exposure to rain or moisture, product not working or being dropped, etc.), the repair has to be performed by an authorized service professional immediately.
14. Before cleaning the product with dry cloth, always turn off the product and disconnect the power plug first.
15. Never use strong acid, alkali, gasoline, alcohol, or other chemical solvents to clean the product surface. Use only neutral solvent or clear water for cleaning.



Excessively loud music may lead to hearing loss. Please keep the volume in a safe range.



Correct Disposal of this product. This marking indicates that this product should not be disposed with other household wastes throughout the EU. To prevent possible harm to the environment or human health from uncontrolled waste disposal, recycle it responsibly to promote the sustainable reuse of material resources. To return your used device, please use the return and collection systems or contact the retailer where the product was purchased. They can take this product for environmental safe recycling.



Use only with the cart, stand, tripod, bracket, or table specified by the manufacturer, or sold with the apparatus. When a cart is used, use caution when moving the cart/apparatus combination to avoid injury from tip-over.

Power warning:

1. Place the product near the power outlet for easy use.
2. Before use, make sure that the operating voltage is the same as your local power supply. Correct operating voltage can be found on the product plate.
3. For safety purpose, unplug the product during lightning storms or when unused for extended periods of time.
4. Under normal conditions, the power supply may get hot. Please keep good ventilation in the area and exercise caution.
5. Safety warning labels on the housing or bottom of the product or power adaptor.



This symbol is to alert the user to the presence of un-insulated dangerous voltage within the product's enclosure that may be of sufficient magnitude to constitute a risk of electric shock to persons.



This symbol is to warn the user not to disassemble the enclosure of the product and there is no user-replaceable part inside. Take the product to an authorized service center for repair.



This symbol indicates that the product is for indoor use only.



This symbol indicates that the product is a CLASS II or double insulated electrical device with no earth requirement.

The MAINS plug is used as the disconnect device, the disconnect device shall remain readily operable.

For wireless product:

1. Wireless product may generate shortwave radio frequencies and interfere with the normal use of other electronic devices or medical equipment.
2. Turn off the product when it's disallowed. Do not use the product in medical facilities, on airplane, at gas stations, near automatic gates, automatic fire alarm system or other automated devices.
3. Do not use the product in the vicinity of a pacemaker within a 20cm range. The radio waves may affect the normal operation of the pacemaker or other medical devices.

Unpack the box

Box Contents

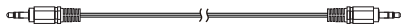
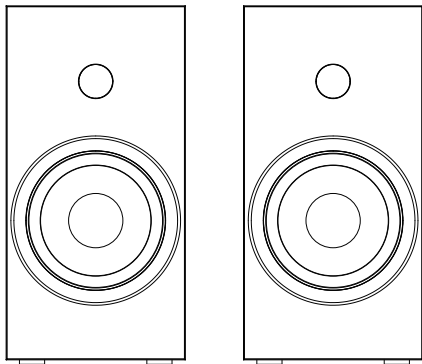

Audio cable



User manual

Rear view of active speaker

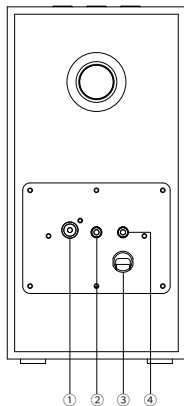

Top view of active speaker

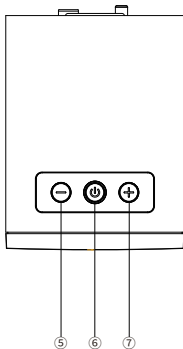

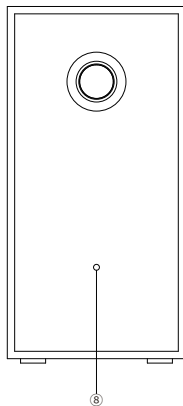

Rear view of passive speaker

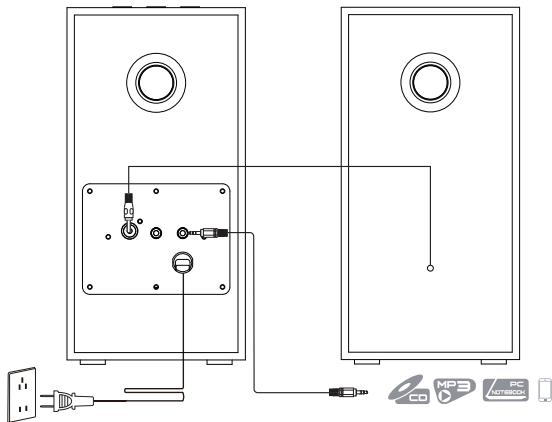

1. Connect to passive speaker
2. Line In input
3. Power cable
4. AUX input
5. Press: volume down
Press and hold: disconnect Bluetooth (Bluetooth input)
6. Power button
Press: input mode switch (Bluetooth - Line In - AUX)
Press and hold: power on/off
LED indicator: Blue (Bluetooth input) Green (Line In/AUX input)
7. Press: volume up
8. Connect to active speaker

Basic Operation



1. Connect speakers using speaker connecting cable from the passive speaker to active speaker.
2. Connect power cable from the active speaker to the wall outlet and turn power switch on, LED indicator will be lit and the speakers should be ready to go.
3. Connect audio source (mobile phone, tablet, etc.) to LINE/AUX input port on the rear panel of the active speaker using audio cable.
4. Press the “” button to switch between Bluetooth and Line In/AUX input modes.
5. Play music via the connected device and adjust the settings to a desired level.

Note: If pressing the “-” or “+” button continuously, LED indicator will flash continuously; When the indicator is no longer flashing, it indicates that the volume has been at the minimum or maximum level.



Green: Line In/AUX



Blue: Bluetooth

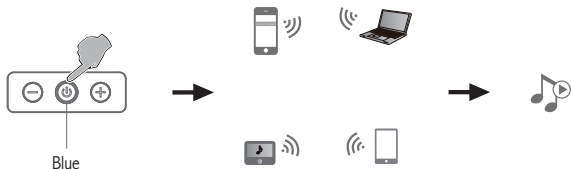

1. Press the “” button to switch to Bluetooth input; LED indicator will flash blue and green alternately;
2. Set your Bluetooth device (mobile phone, tablet, etc.) to search for and connect to “EDIFIER R1080BT”.
3. After pairing is successful, blue indicator will be constantly lit.

Note:

- * The Bluetooth function of R1080BT can only be searched and connected in Bluetooth mode. The current Bluetooth connection will be disconnected once the speaker switches to other audio inputs. When switched back to Bluetooth mode, the speaker will try to connect to the last connected Bluetooth device.
- * Pin code for connection is “0000” if needed.
- * To disconnect Bluetooth, press and hold the “” button on the speaker.
- * To enjoy all Bluetooth functions of this product, please ensure your audio source device has A2DP and AVRCP profile.
- * Bluetooth connectivity and compatibility may differ amongst different source devices, depending on the software versions of source devices.

Specification

Power output:	R/L: 12W+12W
Frequency response:	67Hz-20KHz
Audio input:	AUX, Line in, Bluetooth
Frequency Band:	2.402GHz~2.480GHz
RF Power output:	≤ 20 dBm (EIRP)

There is no restriction of use.

Problem	Solution
No sound	<ul style="list-style-type: none"> • Check if the power indicator light is ON.
	<ul style="list-style-type: none"> • Try to turn up the volume using the volume control.
	<ul style="list-style-type: none"> • Ensure the audio cables are firmly connected and the input is set correctly on the speakers.
	<ul style="list-style-type: none"> • Check if there is a signal output from the audio source.
Cannot connect via Bluetooth	<ul style="list-style-type: none"> • Make sure the speaker is switched to Bluetooth input. If it is in other audio input modes, Bluetooth will not connect. Disconnect from any Bluetooth device by pressing and holding  in Bluetooth mode, then try again.
	<ul style="list-style-type: none"> • Effective Bluetooth transmission range is 10 meters; please ensure that operation is within the range.
	<ul style="list-style-type: none"> • Try another Bluetooth device for connection.
The R1080BT does not turn on	<ul style="list-style-type: none"> • Check if main power is connected, or if the wall outlet is switched on.

To learn more about EDIFIER, please visit www.edifier.com

For Edifier warranty queries, please visit the relevant country page on www.edifier.com and review the section titled Warranty Terms.

USA and Canada: service@edifier.ca

South America: Please visit www.edifier.com (English) or www.edifierla.com (Spanish/Portuguese) for local contact information.

Model: EDF100025

FCC ID: Z9G-EDF138

IC: 10004A-EDF138

Edifier International Limited
P.O. Box 6264
General Post Office
Hong Kong

Tel: +852 2522 6989

Fax: +852 2522 1989

www.edifier.com

© 2021 Edifier International Limited. All rights reserved.

Printed in China

NOTICE:

For the need of technical improvement and system upgrade, information contained herein may be subject to change from time to time without prior notice.

Products of EDIFIER will be customized for different applications. Pictures and illustrations shown on this manual may be slightly different from actual product. Picture for reference only, actual product prevails.