



UHDBT™
4K HDR
HDCP 2.2



PUV-3050TX-UA

**UHD+ HDMI over HDBaseT3 Transmitter
with Analogue Audio I/O & USB 2.0**

OPERATION MANUAL



HDMI[®]
HIGH-DEFINITION MULTIMEDIA INTERFACE

The terms HDMI, HDMI High-Definition Multimedia Interface, and the HDMI Logo are trademarks or registered trademarks of HDMI Licensing Administrator, Inc.

DISCLAIMERS

The information in this manual has been carefully checked and is believed to be accurate. CYP (UK) Ltd assumes no responsibility for any infringements of patents or other rights of third parties which may result from its use.

CYP (UK) Ltd assumes no responsibility for any inaccuracies that may be contained in this document. CYP (UK) Ltd also makes no commitment to update or to keep current the information contained in this document.

CYP (UK) Ltd reserves the right to make improvements to this document and/or product at any time and without notice.

COPYRIGHT NOTICE

No part of this document may be reproduced, transmitted, transcribed, stored in a retrieval system, or any of its part translated into any language or computer file, in any form or by any means—electronic, mechanical, magnetic, optical, chemical, manual, or otherwise—without express written permission and consent from CYP (UK) Ltd.

© Copyright 2021 by CYP (UK) Ltd.

All Rights Reserved.

Version 1.1

TRADEMARK ACKNOWLEDGMENTS

All products or service names mentioned in this document may be trademarks of the companies with which they are associated.



SAFETY PRECAUTIONS

Please read all instructions before attempting to unpack, install or operate this equipment and before connecting the power supply. Please keep the following in mind as you unpack and install this equipment:

- Always follow basic safety precautions to reduce the risk of fire, electrical shock and injury to persons.
- To prevent fire or shock hazard, do not expose the unit to rain, moisture or install this product near water.
- Never spill liquid of any kind on or into this product.
- Never push an object of any kind into this product through any openings or empty slots in the unit, as you may damage parts inside the unit.
- Do not attach the power supply cabling to building surfaces.
- Use only the supplied power supply unit (PSU). Do not use the PSU if it is damaged.
- Do not allow anything to rest on the power cabling or allow any weight to be placed upon it or any person walk on it.
- To protect the unit from overheating, do not block any vents or openings in the unit housing that provide ventilation and allow for sufficient space for air to circulate around the unit.
- Please completely disconnect the power when the unit is not in use to avoid wasting electricity.

VERSION HISTORY

REV.	DATE	SUMMARY OF CHANGE
RDV1	2021/12/06	Preliminary release
RDV1.1	27/10/2022	New IR/RS-232 Diagrams

CONTENTS

1. Introduction	1
2. Applications	1
3. Package Contents	1
4. System Requirements	1
5. Features	2
6. Operation Controls and Functions	3
6.1 Front Panel	3
6.2 Rear Panel.....	4
6.3 IR Cable Pinouts	5
6.4 Serial Pinout	5
6.5 Audio Pinouts.....	5
7. Connection Diagram	6
8. Specifications	7
8.1 Technical Specifications	7
8.2 Video Specifications.....	8
8.3 Audio Specifications.....	10
8.3.1 Digital Audio	10
8.3.2 Analogue Audio	10
8.4 Cable Specifications	11
8.5 HDBaseT Features.....	12
9. Acronyms	13

1. INTRODUCTION

This 4K UHD⁺ HDMI over HDBaseT transmitter uses HDBaseT 3.0, the newest generation of HDBaseT technology, and is the perfect solution for extending full bandwidth (18Gbps) HDMI 2.0, 4K@60Hz (4:4:4, 8-bit) video with HD audio via a single run of Cat.6A/7 cable over distances of up to 40 meters. Multiple control and data signals may also be transmitted along with the audio and video, including IR, RS-232, USB 2.0. This transmitter is ideal for use in any video extension scenario, especially when latency-free, uncompressed, high resolution video is critical, such as medical installations, live conferences, and education.

When used with its matched receiver, 2 micro USB host connections are available (1 on the transmitter, 1 on the receiver) for connecting a single USB host (such as a laptop or PC) to devices on up to 4 USB 2.0 (Type-A) ports (2 on the transmitter, 2 on the receiver) forming a highly flexible KVM extension configuration.

2. APPLICATIONS

- /// Household entertainment sharing and control
- /// Lecture hall/classroom display and control
- /// Meeting room presentation and control

3. PACKAGE CONTENTS

- /// 1× UHD⁺ HDMI over HDBaseT Transmitter with USB KVM
- /// 1× 24V/2.7A DC Power Adapter
- /// 2× 3-pin Terminal Block
- /// 1× 8-pin Terminal Block
- /// 1× Operation Manual

4. SYSTEM REQUIREMENTS

- /// HDMI source equipment such as media player, video game console, or set-top box.
- /// HDMI receiving equipment such as an HDTV, monitor, or audio amplifier.
- /// A compatible HDBaseT receiver with PoH (PD) support is recommended.
- /// The use of Premium High Speed HDMI cables, and industry standard Cat.6A or Cat.7 Ethernet cable is highly recommended.

5. FEATURES

- /// HDMI 2.0 and DVI 1.0 compatible
- /// HDCP 2.2 and HDCP 1.x compliant
- /// HDBaseT 3.0 compliant (Backwards compatible with HDBaseT 2.0/1.0)
- /// 1 HDMI input, 1 HDMI output, and 1 HDBaseT output
- /// Supports up to 4K UHD⁺ (18Gbps, 4K@60Hz 4:4:4, 8-bit) video input and output over both HDMI and HDBaseT
- /// Supports Deep Colour input and output up to 12-bit
- /// Supports 10-bit and 12-bit HDR (High Dynamic Range) input/output
- /// Supports CEC bypass
- /// HDBaseT extends video, audio and data over a single Cat.6A/7 cable and can reach distances up to 40m/131ft
- /// HDBaseT feature support: HD Video and Audio, PoH (PSE), Bi-directional audio (analogue), and Control (bi-directional USB/IR/RS-232 pass-through)
- /// 2 USB 2.0 Type-A device ports and 1 Micro USB host port
- /// Selectable HDMI audio extraction/analogue audio bypass functionality when paired with a compatible receiver
- /// HDMI output functions as a local monitor
- /// Supplies PoH to the connected receiver

6. OPERATION CONTROLS AND FUNCTIONS

6.1 Front Panel

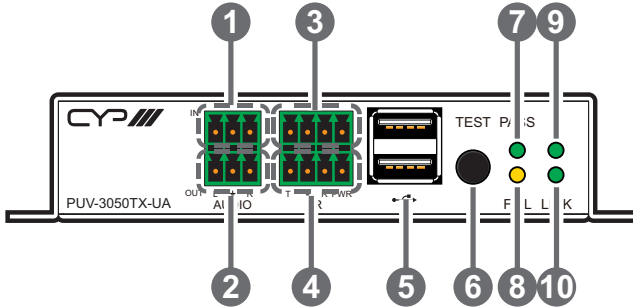

- 1 AUDIO IN 3-pin Terminal Block:** Connect to the analogue audio output of a device such as a media player or game console using a 3-pin adapter cable. Audio is sent to the analogue audio output on the connected compatible receiver.
- 2 AUDIO OUT 3-pin Terminal Block:** Connect to powered speakers or an amplifier for analogue audio output using a 3-pin adapter cable. Audio is sourced from the analogue audio input on the connected compatible receiver.
- 3 RS-232 4-pin Terminal Block:** Connect to a PC, laptop, or serial controllable device with a 4-pin adapter cable for the extension of RS-232 signals between both ends of the HDBaseT connection.
- 4 IR 4-pin Terminal Block (In/Out):** Connect to both an IR Blaster and Extender using a 4-pin Y-adapter cable to transmit and receive IR control signals and extend them to devices connected to the other end of the HDBaseT connection.
- 5 USB 2.0 Ports (Type-A):** Connect directly to standard USB devices such as a mouse, keyboard, or flash drive to extend their USB functionality to the currently active Micro-USB host port.
- 6 TEST Button:** Press this button to initiate a simple HDBaseT cable quality test. While the test is in process, both the TEST and FAIL LEDs will blink.

Note: This feature requires connection to a compatible receiver. This function will not provide a result if no receiver is connected.

- 7 PASS LED:** This LED will illuminate solidly to indicate that the most

recent cable test result was successfully passed.

- 8 **FAIL LED:** This LED will illuminate solidly to indicate that the most recent cable test resulted in a failure with too many detected errors.
- 9 **POWER LED:** This LED will illuminate to indicate the unit is on and receiving power.
- 10 **LINK LED:** This LED will illuminate solidly when a live connection with a compatible receiver is active.

6.2 Rear Panel

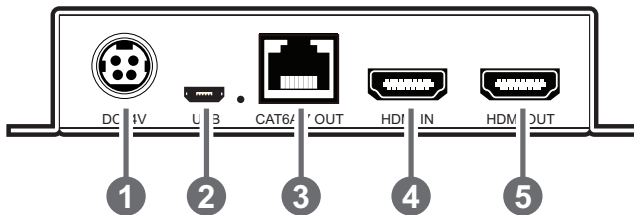

- 1 **DC 24V/2.7A Port:** Plug the 24V/2.7A DC power adapter into this port and connect it to an AC wall outlet for power.
- 2 **USB 2.0 Port (Micro-B) & LED:** Connect directly to a standard USB host such as a PC or laptop to extend their USB functionality to all currently connected USB devices on both ends of the HDBaseT connection. The LED will illuminate solidly to indicate when the USB port is active.

Note: If USB hosts are connected to both the transmitter and receiver at the same time, only the most recently connected host will be active.

- 3 **CAT6A/7 OUT Port:** Connect to a compatible HDBaseT receiver with a single Cat.6A/7 cable for extension of all data signals. PoH will also be supplied to a connected compatible PD receiver.

Note: The PoH function is designed for powering compatible receiver units only. Non-PoH receivers will need their own power supply. Receivers from other brands may not be compatible.

- 4 **HDMI IN Port:** Connect to HDMI source equipment such as a media player, game console, or set-top box.
- 5 **HDMI OUT port:** Connect to an HDMI TV, monitor, or amplifier for digital video and audio output.

6.3 IR Cable Pinouts

IR Blaster + IR Extender

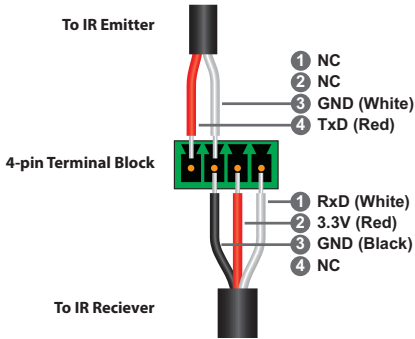

6.4 Serial Pinout

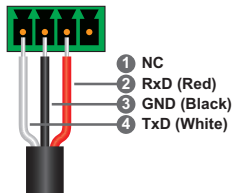

6.5 Audio Pinouts

Stereo Audio Input

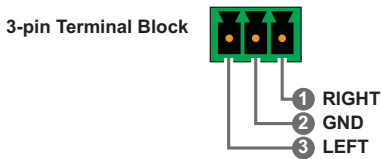

Stereo Audio Output

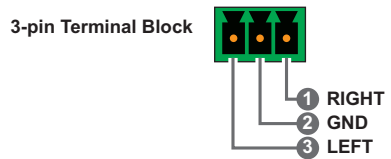

7. CONNECTION DIAGRAM

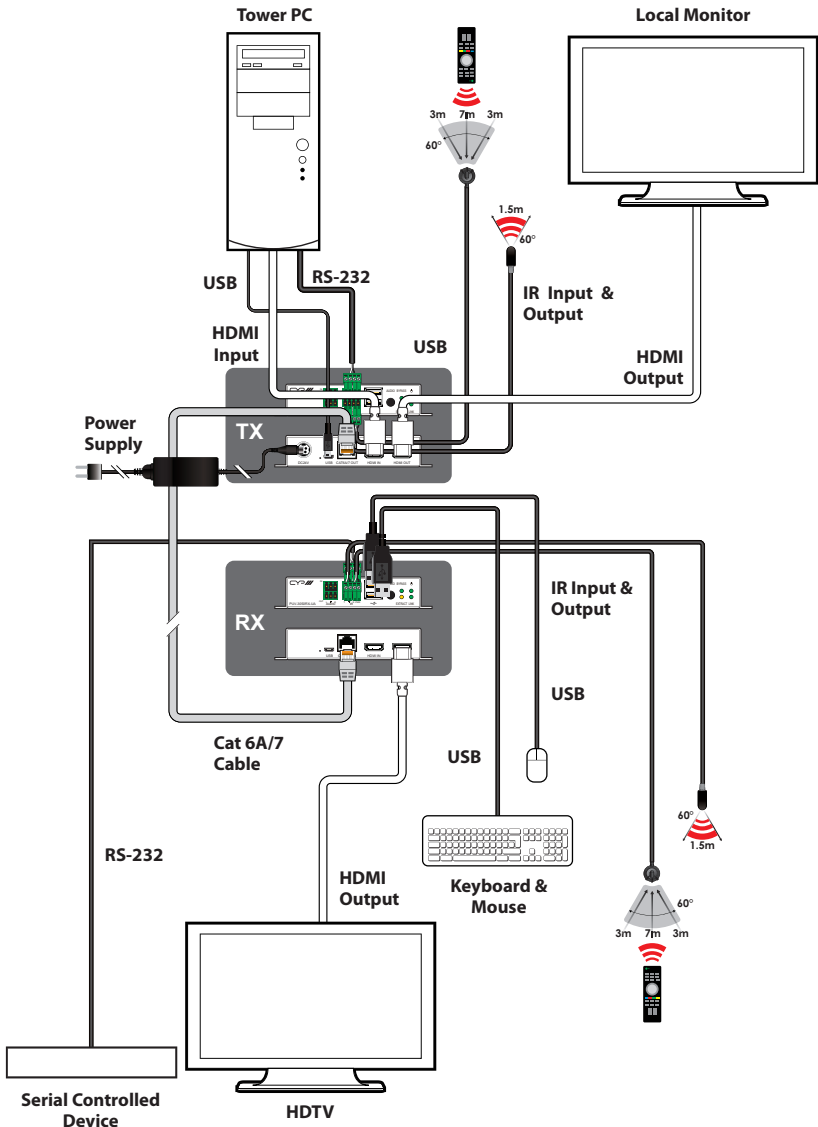

8. SPECIFICATIONS

8.1 Technical Specifications

HDMI Bandwidth	18Gbps
HDBaseT Bandwidth	18Gbps
Input Ports	1×HDMI (Type-A) 1×Analogue Stereo (3-pin Terminal Block)
Output Ports	1×HDBaseT (RJ-45) 1×HDMI (Type-A) 1×Analogue Stereo (3-pin Terminal Block)
Pass-through Ports	1×IR In/Out (4-pin Terminal Block) 1×RS-232 (4-pin Terminal Block) 2×USB 2.0 (Type-A)
Pass-through/Service Port	1×USB 2.0 (Micro-B)
IR Frequency	30 ~ 50kHz (30 ~ 60kHz under ideal conditions)
Baud Rate	Up to 115200
Power Supply	24V/2.7A DC (US/EU standards, CE/FCC/UL certified)
ESD Protection (HBM)	±8kV (Air Discharge) ±4kV (Contact Discharge)
Dimensions (W×H×D)	128mm×25mm×108mm [Case Only] 128mm×25mm×112.5mm [All Inclusive]
Weight	400g
Chassis Material	Metal (Steel)
Chassis Colour	Black
Operating Temperature	0°C – 50°C/32°F – 122°F
Storage Temperature	-20°C – 60°C/-4°F – 140°F

Relative Humidity 20 – 90% RH (Non-condensing)

Power Consumption 12W

8.2 Video Specifications

Supported Resolutions (Hz)	Input	Output	
	HDMI	HDMI	HDBT
720×400p@70/85	✓	✓	✓
640×480p@60/72/75/85	✓	✓	✓
720×480i@60	✓	✓	✓
720×480p@60	✓	✓	✓
720×576i@50	✓	✓	✓
720×576p@50	✓	✓	✓
800×600p@56/60/72/75/85	✓	✓	✓
848×480p@60	✓	✓	✓
1024×768p@60/70/75/85	✓	✓	✓
1152×864p@75	✓	✓	✓
1280×720p@50/60	✓	✓	✓
1280×768p@60/75/85	✓	✓	✓
1280×800p@60/75/85	✓	✓	✓
1280×960p@60/85	✓	✓	✓
1280×1024p@60/75/85	✓	✓	✓
1360×768p@60	✓	✓	✓
1366×768p@60	✓	✓	✓
1400×1050p@60	✓	✓	✓
1440×900p@60/75	✓	✓	✓
1600×900p@60RB	✓	✓	✓
1600×1200p@60	✓	✓	✓

Supported Resolutions (Hz)	Input	Output	
	HDMI	HDMI	HDBT
1680×1050p@60	✓	✓	✓
1920×1080i@50/60	✓	✓	✓
1920×1080p@24/25/30	✓	✓	✓
1920×1080p@50/60	✓	✓	✓
1920×1200p@60RB	✓	✓	✓
2560×1440p@60RB	✓	✓	✓
2560×1600p@60RB	✓	✓	✓
2048×1080p@24/25/30	✓	✓	✓
2048×1080p@50/60	✓	✓	✓
3840×2160p@24/25/30	✓	✓	✓
3840×2160p@50/60 (4:2:0)	✓	✓	✓
3840×2160p@24, HDR10	✓	✓	✓
3840×2160p@50/60 (4:2:0), HDR10	✓	✓	✓
3840×2160p@50/60	✓	✓	✓
4096×2160p@24/25/30	✓	✓	✓
4096×2160p@50/60 (4:2:0)	✓	✓	✓
4096×2160p@24, HDR10	✓	✓	✓
4096×2160p@50/60 (4:2:0), HDR10	✓	✓	✓
4096×2160p@50/60	✓	✓	✓

8.3 Audio Specifications

8.3.1 Digital Audio

HDMI Input / HDMI & HDBaseT Output	
LPCM	
Max Channels	8 Channels
Sampling Rate (kHz)	32, 44.1, 48, 88.2, 96, 176.4, 192
Bitstream	
Supported Formats	Standard & High-Definition

8.3.2 Analogue Audio

Analogue Input	
Max Audio Level	2Vrms
Impedance	10kΩ
Type	Unbalanced
Analogue Output	
Max Audio Level	2Vrms
THD+N	< -80dB@0dBFS 1kHz (A-wt)
SNR	> 80dB@0dBFS
Frequency Response	< ±0.5dB@20Hz~20kHz
Crosstalk	< -71dB@10kHz
Impedance	499Ω
Type	Unbalanced

8.4 Cable Specifications

Cable Length	1080p		4K30	4K60
	8-bit	12-bit	(4:4:4) 8-bit	(4:4:4) 8-bit
High Speed HDMI Cable				
HDMI Input	10m	10m	5m	3m
HDMI Output	10m	10m	5m	3m
Ethernet Cable				
Cat.5e/6	*			N/A
Cat.6A/7	40m			

**Results with Cat 5e/6 will vary*

Bandwidth Category Examples:

1080p (FHD Video)

- Up to 1080p@60Hz, 12-bit colour
- Data rates lower than 5.3Gbps or below 225MHz TMDS clock

4K30 (4K UHD Video)

- 4K@24/25/30Hz & 4K@50/60Hz (4:2:0), 8-bit colour
- Data rates higher than 5.3Gbps or above 225MHz TMDS clock but below 10.2Gbps

4K60 (4K UHD+ Video)

- 4K@50/60Hz (4:4:4, 8-bit)
- 4K@50/60Hz (4:2:0, 10-bit HDR)
- Data rates higher than 10.2Gbps

8.5 HDBaseT Features

HDBaseT Feature Set	Transmitter
Video & Audio Extension	Supported
LAN Extension	Unsupported
Send power to Receiver	Supported (PoH)
Accept power from Receiver	Unsupported
IR Extension	Supported
RS-232 Extension	Supported
USB 2.0 Extension	Supported

9. ACRONYMS

ACRONYM	COMPLETE TERM
4K UHD	4K Ultra-High-Definition (10.2Gbps max)
4K UHD⁺	4K Ultra-High-Definition (18Gbps max)
AVoIP	Audio/Video over IP
Cat.5e	Enhanced Category 5 cable
Cat.6	Category 6 cable
Cat.6A	Augmented Category 6 cable
Cat.7	Category 7 cable
DVI	Digital Visual Interface
EDID	Extended Display Identification Data
GbE	Gigabit Ethernet
Gbps	Gigabits per second
HDBT	HDBaseT
HDCP	High-bandwidth Digital Content Protection
HDMI	High-Definition Multimedia Interface
HDR	High Dynamic Range
IR	Infrared
kHz	Kilohertz
LED	Light-Emitting Diode
LPCM	Linear Pulse-Code Modulation
MHz	Megahertz
PD	Powered Device
PoH	Power over HDBaseT
PSE	Power Sourcing Equipment
TMDS	Transition-Minimised Differential Signaling

ACRONYM	COMPLETE TERM
USB	Universal Serial Bus
VGA	Video Graphics Array
WUXGA (RB)	Widescreen Ultra Extended Graphics Array (Reduced Blanking)
XGA	Extended Graphics Array



CYP (UK) Ltd., Unit 7, Shepperton Business Park, Govett Avenue,
Shepperton, Middlesex, TW17 8BA

Tel: +44 (0) 20 3137 9180 | Fax: +44 (0) 20 3137 6279

Email: sales@cypeurope.com

www.cypeurope.com

RDV1.1