

DENON®

PMA-900HNE

Integrated Network Amplifier

# Quick start guide

# Before you begin

## What's in the box

---

Quick start guide



Safety Instructions



Cautions on Using Batteries



Notes on radio

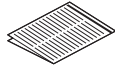

Network Integrated Amplifier

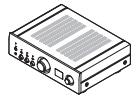

Power cord

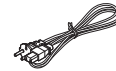

Remote control (RC-1246)



2× R03/AAA batteries



External antennas for Bluetooth®/Wi-Fi® connectivity



## Required for setup

---

Speakers



Speaker cables



Mobile device



Wi-Fi Router and Internet connection

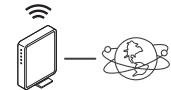

## Optional

---

Ethernet cable



# Setup

## 1 Connect the antennas

- 1 Place the antenna squarely over the antenna terminal in the upper-left or upper-right corner of the rear panel.
- 2 Turn the antenna clockwise until it is fully connected. Do not over tighten.
- 3 Rotate the antenna upwards for the best possible reception.

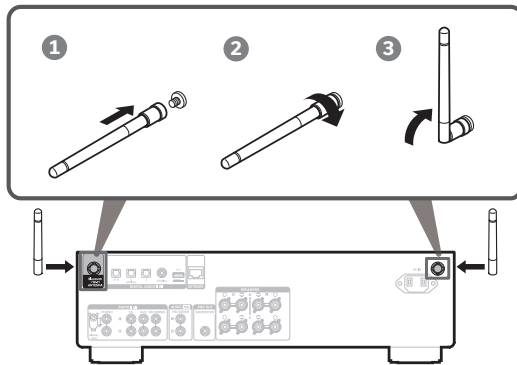

### NOTE

The antennas are required for both Bluetooth and Wi-Fi functions.

### Optional

If you are connecting PMA-900HNE to a wired network, connect an Ethernet cable (not included) between the amplifier and your router. Do not connect the Ethernet cable if you are connecting the amplifier to a wireless network.

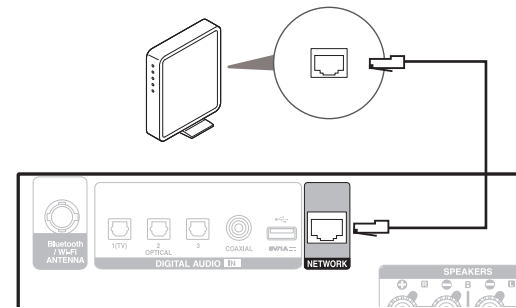

# 2

## Connect your speakers

Connect your speaker cables between the PMA-900HNE and your speakers.

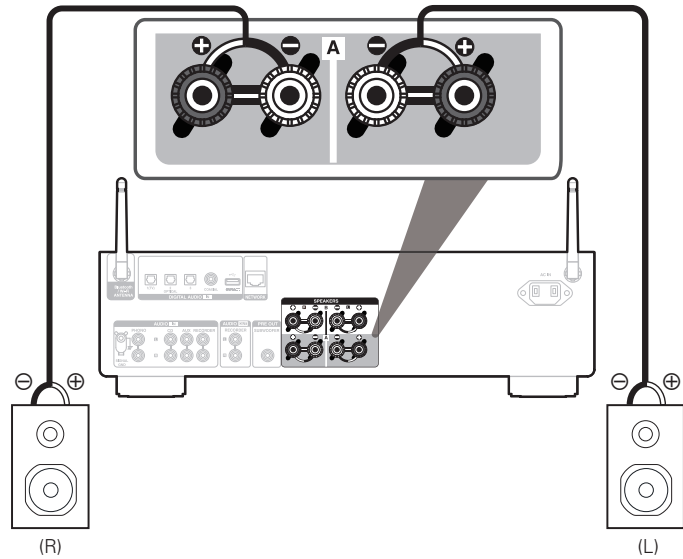

### 3 Connect to power

Connect the power cable between the PMA-900HNE and a wall outlet.

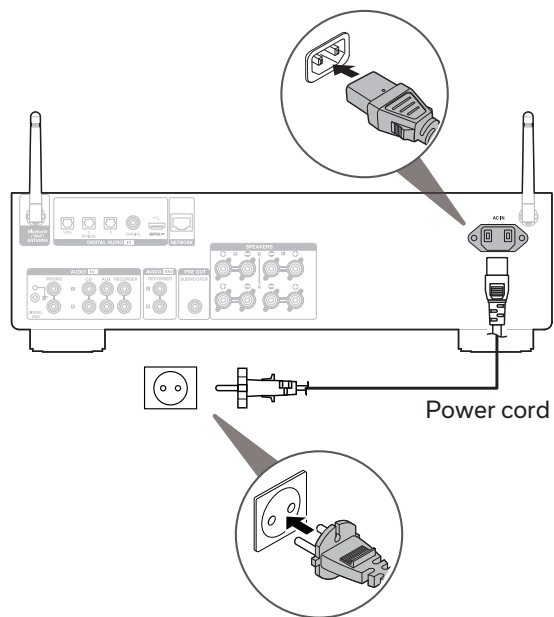

### 4 Install batteries in the remote control

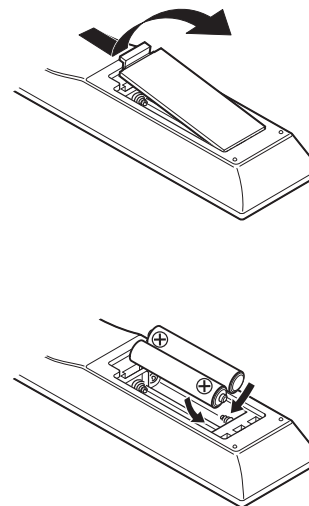

- Batteries can be taken out in reversed order.

## 5 Use the HEOS app to complete PMA-900HNE setup

- 1 Go to the Apple App Store, Google Play or Amazon App Store and search for "HEOS" to download and install.



- 2 Launch the HEOS app and follow the instructions in the app.

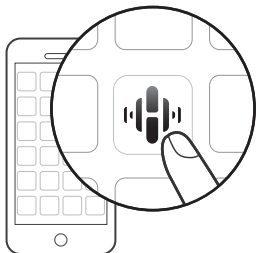

## 6 Add device

If you already have the HEOS app and have setup at least one HEOS built-in device, please follow the steps below to add the PMA-900HNE to your wireless network.

- 1 Select the Settings  icon in the upper-left corner of the main "Music" menu to display the Settings menu.

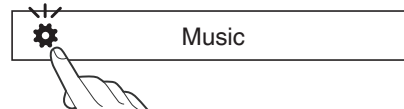

- 2 Select "Add Device" from the HEOS app's Settings menu and follow the instructions:

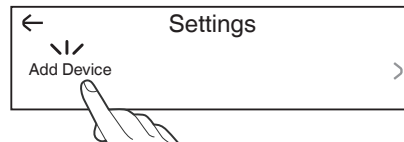

# Playing music - Bluetooth

## 1 Press Bluetooth to select Bluetooth.

When you use it for the first time, the amplifier automatically enters pairing mode and "Bluetooth Pairing..." appears on the display.



Bluetooth  
Pairing...

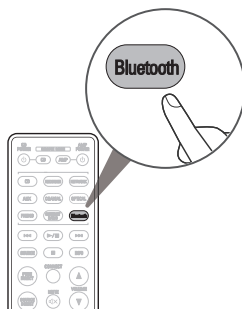

## 2 Activate Bluetooth on your mobile device.

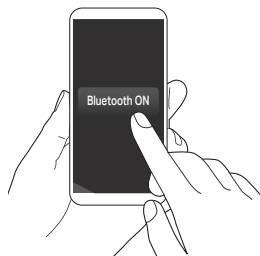

## 3 Select "Denon PMA-900HNE" from the Bluetooth device list.

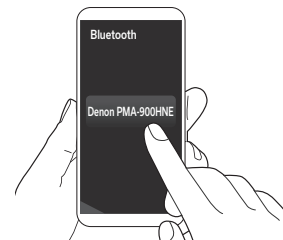

## 4 Play music using any app on your device.

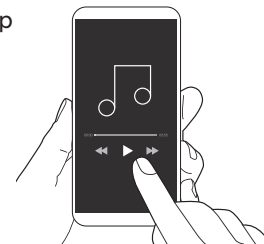

- To pair with other Bluetooth devices, press and hold Bluetooth on the remote control until "Bluetooth Pairing..." is displayed on the unit.

# Owner's manual

Refer to the online manual for other functions information and operation procedure details.

[manuals.denon.com/PMA900HNE/EU/EN/](http://manuals.denon.com/PMA900HNE/EU/EN/)

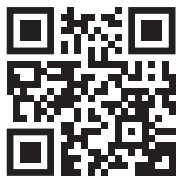

Online manual

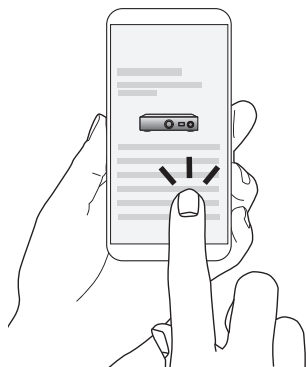

For more information, visit [www.denon.com](http://www.denon.com)



## Trademark information



The Bluetooth® word mark and logos are registered trademarks owned by the Bluetooth SIG, Inc. and any use of such marks by D&M Holdings Inc. is under license. Other trademarks and trade names are those of their respective owners.



The Wi-Fi CERTIFIED logo is a registered trademark of the Wi-Fi Alliance. Wi-Fi Certification provides assurance that the device has passed the interoperability test conducted by the Wi-Fi Alliance, a group that certifies interoperability among wireless LAN devices.

**DENON®**

[www.denon.com](http://www.denon.com)

Printed in Vietnam 5411 11958 00AD  
© 2022 Sound United. All Rights Reserved.