

All the pictures below are for illustrations only. Specifics are subject to the actual product.



# Foreword

Thank you so much for purchasing FiiO's portable high resolution lossless music player M17. We have prepared this complete user manual for you. We hope this manual can help you get the hang of the M17 and unleash its full potential.

## An introduction to FiiO M17

The smart desktop-class M17 is an entirely new chapter of FiiO digital audio players. Its desktop-grade DAC, amplification, power supply, etc. give it the output power and sound quality to rival and perhaps even surpass highly-regarded desktop systems – but in a portable package.

The left and right audio channels each contain a desktop-class, 8-channel ES9038PRO flagship DAC. This means that each audio channel has 8 parallel outputs summed together for superior resolution and minimal distortion for extremely pure audio reproduction.

The desktop-class THX 788+ headphone amp has an output power of up to 3000mW per channel with a lower output impedance – allowing it to more effortlessly power all kinds of headphones.

Desktop-grade power supply and gain: the M17 contains two power supplies – a battery power supply and a power supply powered by external DC power. Under battery power, there are 4 gain levels: low, medium, high, and headphone mode. When under DC mode, the enhanced over-ear headphone mode gain is unlocked which can go as high as 16dB in balanced output.

Desktop-caliber internals: high-end TI OPA2211 op-amp, supercapacitor, ultra-low noise LT3045 LDO, NDK femtosecond crystal oscillator, etc.

Desktop-level connectivity: not only supports commonly used 2.5mm/3.5mm/4.4mm headphone outputs, but also adds 6.35mm output, RCA coaxial port, USB3.0 and USB2.0 ports.

With desktop-grade configurations, the M17 will be your great partner on the road of music.

# Buttons and ports

## 1. Pictorial guide to buttons and ports

(Pictures are for reference only. The real product may vary.)

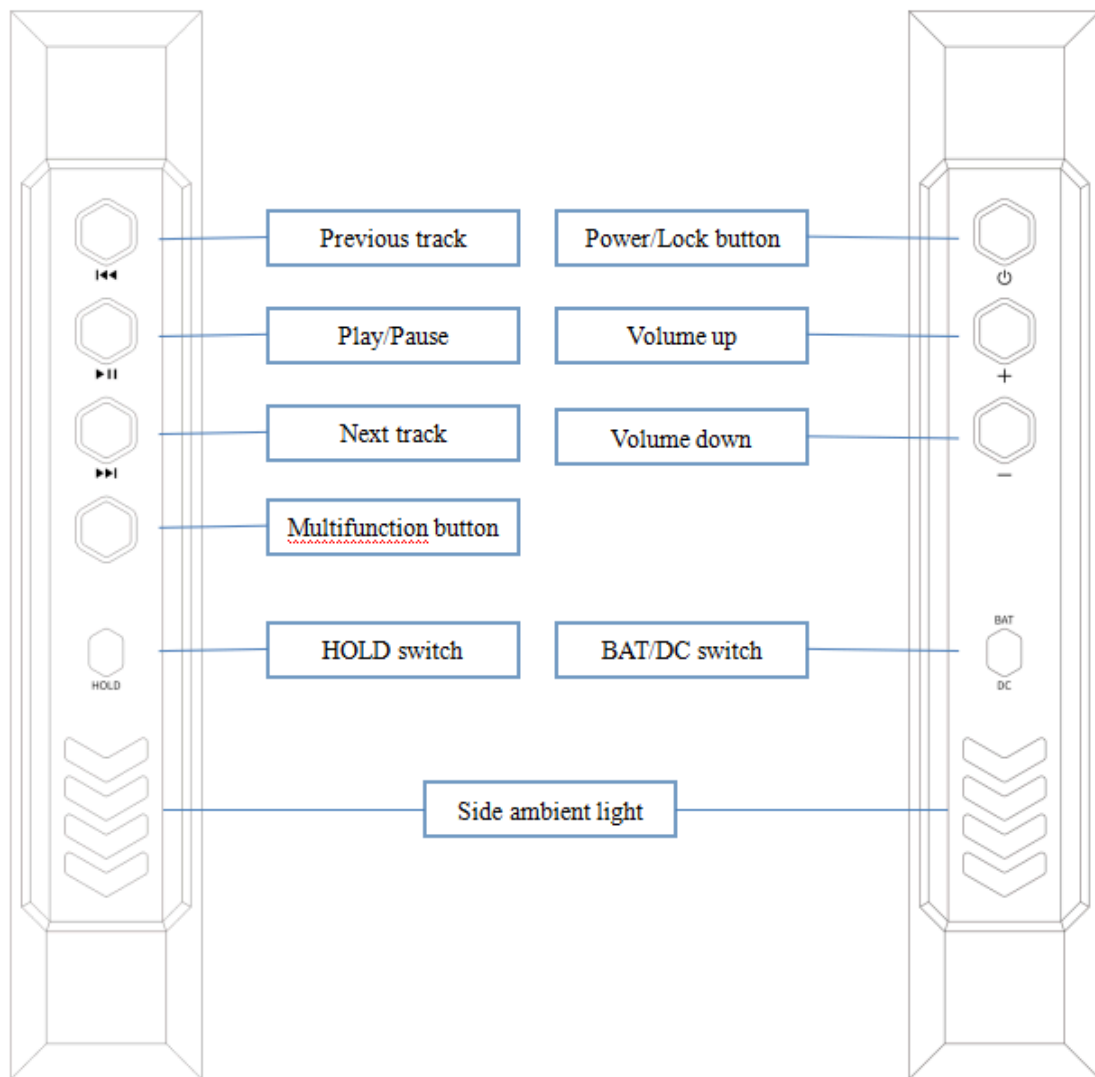

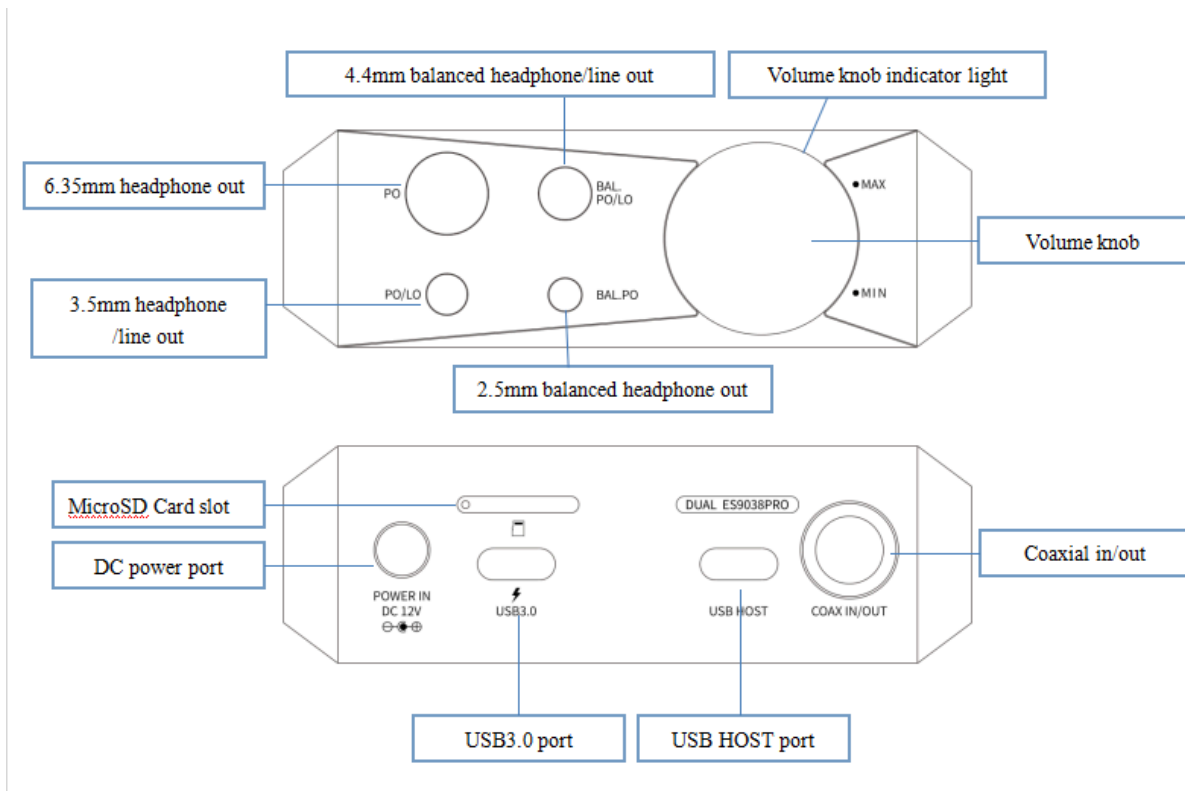

## 2. Instructions for buttons and ports

- 1) Power/Lockscreen: long press it for about 2 seconds when the device is off to turn it on; long press it when the device is on the pop up the menu of reboot/shutdown; short press it when the device is on to turn off/wake up the screen; long press it for about 10 seconds to reset the device.
- 2) Volume up/down: press the volume up button to increase the volume, press the volume down button to decrease the volume.
- 3) BAT/DC switch: when the switch is set to BAT, the system will use the battery as a power source. When the switch is set to DC and the DC power adapter is connected(there is a power adapter in the accessories of the M17), the system will switch to DC power supply. At this time, the enhanced over-ear headphones mode will be added to the gain setting menu, and the system will pop up a window to prompt it, please choose whether to switch according to your needs. In the enhanced over-ear headphones mode, M17 will be able to provide greater output power, suitable for high-impedance headphones.
- 4) Previous track: short press to play the previous track; long press to rewind.
- 5) Play/Pause: short press it when music is playing to pause the music; short press it when music is paused to resume the playback.
- 6) Next track: short press to play the next track; long press to fast forward.

7) Multi-function button: you can customize the multi-function buttons to select a frequently used function for one-button quick start.

For example, you can set the button to add to favorites, random play, play/pause, switch filter, switch equalizer, delete the currently playing song, switch to USB DAC mode, switch to Bluetooth mode, no function, etc.

8) Hold switch: you can customize it. After turning it on, the buttons and knobs that are in the off state will be locked.

9) DC power port: 12V DC power supply port, after connecting to the power adapter and turning the switch to DC, the hidden gain mode---enhanced over-ear headphones mode will be triggered

10) Micro SD Card slot: supports one TF card (micro SD card), theoretically up to 2TB expansion.

11) USB 3.0 port: supports data transfer with computers, USB DAC, USB Audio output, USB OTG, USB charging and other functions

12) USB HOST (2.0): supports USB Audio output and USB OTG, but does not support functions such as connecting to a computer or charging.

13) Coaxial in/out: the M17 coaxial port supports output and input of coaxial signals.

14) 6.35mm headphone out: supports 6.35mm headphone output.

15) 3.5mm headphone/line out:supports 3.5mm headphone/line-out output.

16) 4.4mm balanced headphone/line out: supports 4.4mm balanced headphone/line-out output.

17) 2.5mm balanced headphone out: supports 2.5mm balanced headphone output.

18) Volume knob: the M17 uses the volume knob to adjust the volume by default. At this time, the volume button cannot adjust the volume. If you need to switch, you can enter Settings-Global, click "Volume Adjusting Mode", select "Adjust by Volume button" or "Adjust by Volume Knob".

### **The priority of the M17 output port**

1. When the PO 3.5mm, 6.35mm, 2.5mm and 4.4mm are output at the same time, the output will be given priority in the order of insertion; if the 6.35 and 3.5 earphones are inserted at the same time, both ports have output, and the status bar will display two icons (The same is true for LO); 2.5 and 4.4 are the same as 6.35 and 3.5.

2. When both balanced and single-ended headphones are plugged in, the first plugged-in headset will have a sound, and the status bar will only display the first plugged-in headset icon.

3. The SPDIF output is controlled by a separate switch. The analog output (PO/LO) and SPDIF digital output can be output at the same time.

4. According to the Android system's own processing method, Bluetooth transmission and analog output (including SPDIF) will follow the principle of post-access priority.

## Status bar and display page

### 1. Status bar

The status bar on the top screen shows the working states of the M17.















**ICON MEANINGS OF THE M17 PLUS LTD**

**UI Icons in Status Bar**

50	Current volume	100%	Remaining battery
20%	Low battery	20%	Charging
	FIIO Music is running		Downloading
	Download finished		4.4 balanced out
	6.35 PO		4.4 balanced line out
	Headphone output		2.5 balanced headphone out
	Line out		2.5 balanced line-out
	WiFi connected		Bluetooth connected
	Bluetooth disconnected		aptXHD Bluetooth transmitting
	LDAC Bluetooth transmitting		aptX Bluetooth transmitting
	HOLD switch on	15:37	Current time
	Screenshot		New firmware detected
	Over high temperature		Over low temperature
	MQA		Stop charging the battery

## O2 Icons in Drop Down Menu

Icon P states	Icon N states	Usage scenarios		Icon P states	Icon N states	Usage scenarios
		PO				LO
		Spdif				Auto-rotate
		BALLO				BAL.PO
		Low gain				Bluetooth
		Medium gain				WLAN
		High gain				In-vehicle mode
		Dark theme				Mode choose
		Night light				All to DSD
		Over-ear headphone mode				Enhanced over-ear headphone mode
		Volume adjusting mode				

### 03 Icons of Working Modes

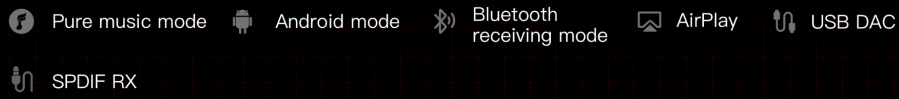

### 04 Icons of Settings menu

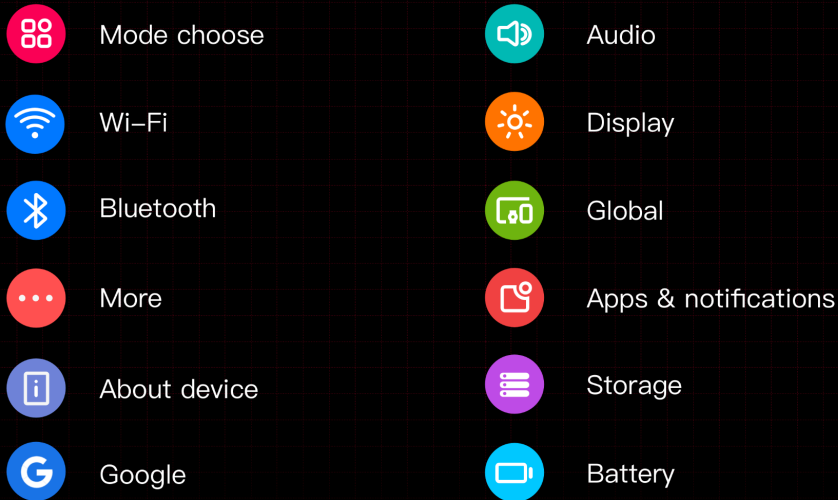

## 2. Homepage and drop-down menu

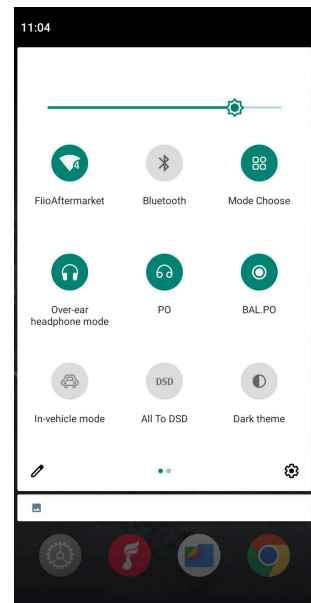
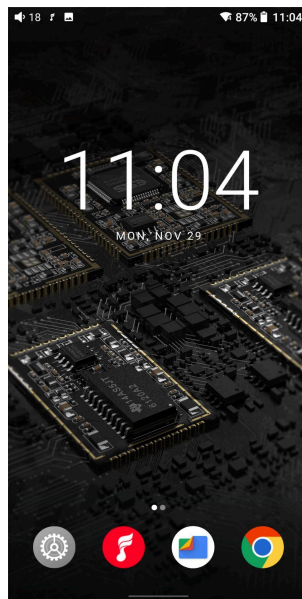
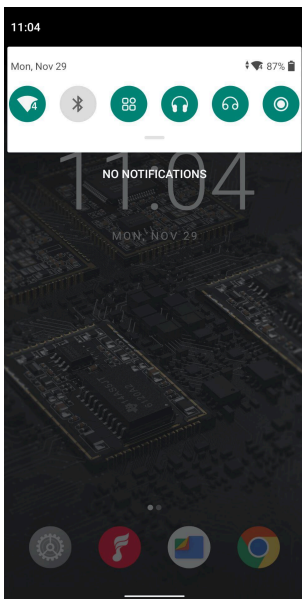



# Instructions for entry-level functions

## 1. Six working modes

The M17 has 6 independent working modes: Android mode, Pure Music mode, Bluetooth Receiving mode, USB DAC mode and AirPlay mode. It is defaulted to be the Android mode, which can be switched to other working modes in the drop-down menu.

If the player is in other modes but not the Android mode, you can switch it to other modes through the selection on the display, or tap Settings->Exit to go back to Android mode.

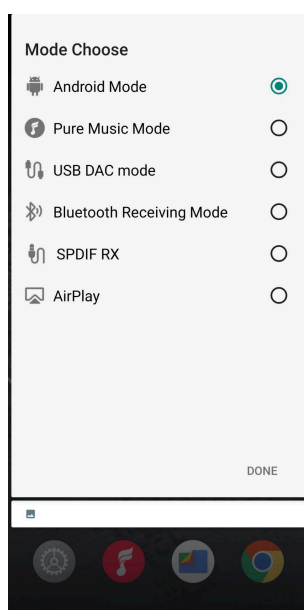

### Android mode

Third party applications will be available at will. It can be switched to other modes on the drop-down or settings menu.

### Pure Music mode

Third party applications will be automatically disabled while the FiiO Music app will be auto-enabled. It can be switched to other modes on the drop-down or settings menu.

## USB DAC mode

In USB DAC mode, the M17 can be connected to other devices like a computer, working as a USB DAC/Amp. It can be switched to other modes on the drop-down or settings menu.

*Notes: when the M17 is going to work in the USB DAC mode for the first time, FiiO's exclusive USB DAC driver is required. Please download it on our website and follow relevant instructions to install it.*

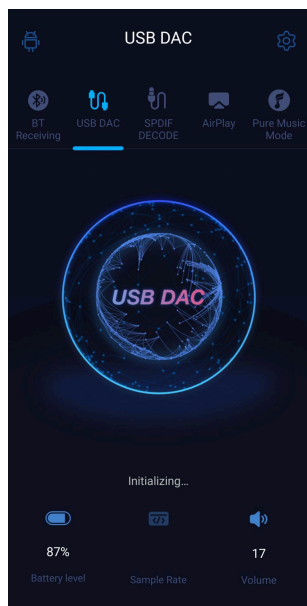

## Bluetooth Receiving mode

1. When switching to the Bluetooth Receiving mode for the first time, the M17 will automatically enter the pairing state. The next time it enters Bluetooth Receiving mode, it will reconnect to the last connected device automatically.

2. Go to the Bluetooth transmitting list of the mobile phone, and tap the M17 to complete the connection.

-Force the device to enter pairing mode: Hold the Play/Pause button for about 3 seconds.

-Manually enter reconnecting mode: Short press the Play/Pause button when not in pairing mode.

-Clear current pairing: Hold the Previous and Next track buttons at the same time for about 3 seconds.

-Play/Pause: Short press the Play/Pause button.

-Previous/Next track: Short press the Previous/Next track button.

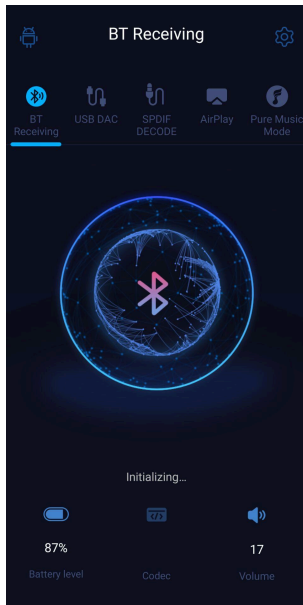

## SPDIF RX mode

When switching to the SPDIF RX mode, the system will automatically enable the coaxial port as coaxial input mode. At this time, the M17 will start to decode the input valid coaxial signals.

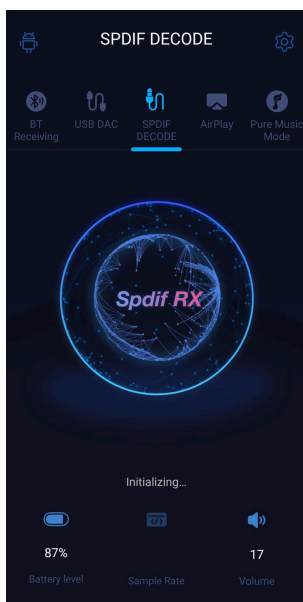

## AirPlay

When working in AirPlay mode, the M17 requires a valid WiFi connection. Please confirm that it is connected to an available network before entering AirPlay mode.

There are mainly 3 steps.

1. Make sure the M17 and your iOS devices are connected to the same WiFi network.
2. Switch the M17 to the AirPlay mode.
3. On the drop-down menu of the iOS device, choose the M17 as the playing device. So the M17 can receive audio signals from the iOS device.

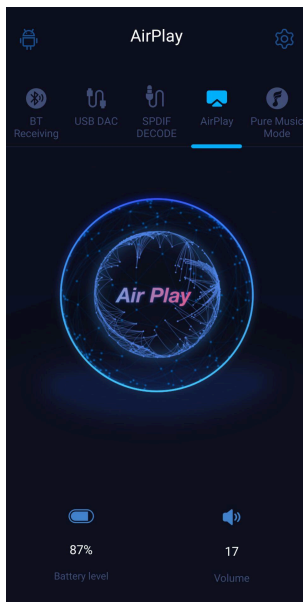

## 2. How to access the storage/SD card after connecting the M17 to a computer?

### Windows system

For Windows computers, it is driver-free. After connecting the M17 to the computer by the included USB cable, the driver will be automatically installed. Then the FiiO M17 disk can be directly seen on the computer

### Mac system

Mac computers need a driver.

1. After connecting the M17 to the Mac computer, click the "NO NAME" folder emerging on the desktop->double click Mac->Mac/MAC OS MTP Client->Android File Transfer.dmg. Drag the "Android File Transfer.dmg" to the desktop of the computer.

2. Drag the "Android File Transfer" file to the "Applications" folder and wait for the completion of the copy.

3. Enter "Applications", and double click the "Android File Transfer". Then

you can manage the files stored in the internal storage of the M17 or the Micro

SD card.

Notes: The M17 folder will directly pop up the next time it is being connected to the same computer.

## 3. How to upgrade firmware?

The M17 supports online upgrade and local upgrade.

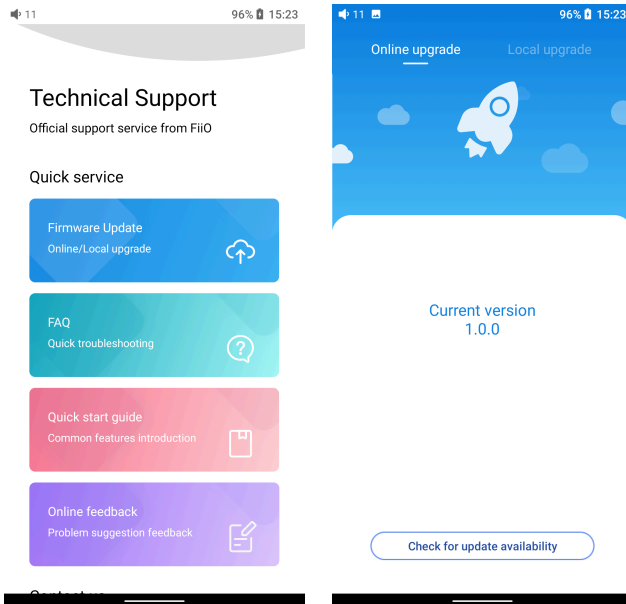

## Online upgrade

If a new firmware is available and can be detected (with the M17 connected to an available internet), an upgrade notification will show up in the notification center. Tap on it to enter the update menu for the online upgrade. If there's no upgrade notification showing up, you can go to the "Technical Support->Firmware Upgrade" menu, and tap the "Check for updates" icon to check manually.

## Local upgrade

Also, the M17 can be upgraded locally by a firmware package. Download the firmware package file from FiiO website, and copy it to the internal storage of the M17 or an SD card. Go to the "Technical Support->Firmware Upgrade->Local Upgrade" menu, and find the firmware package file to start the upgrade.

Notes:

1. Do not unzip the firmware package file.

2. Before the upgrade, ensure the power of the device is adequate (>30%) so to avoid upgrade failure.

3. If the device goes to factory mode which cannot detect the firmware, the reason may be that the firmware file is damaged. At this time, press the power button to reboot the device. Re-download the firmware file and restart the upgrade.

## 4. How to install third-party apps?

There are two ways that are similar to mobile phones' to install applications.

Method 1: After connecting the device to a valid WiFi, go to FiiO market, Google Play or other app markets to download and install the app directly.

Method 2 (Local installation): copy the APK file to the M17. Go to the file management menu to find the file and install it.

## 5. How to change the language?

Go to Settings->System->Languages and input->Languages->+ Add a language to choose the intended language. Press the "=" icon on the right side and drag it to the first line to select the language successfully.

The language of the FiiO Music app defaults to follow the system's. You can also go to FiiO Music app-> Settings->Languages to choose the language independently.

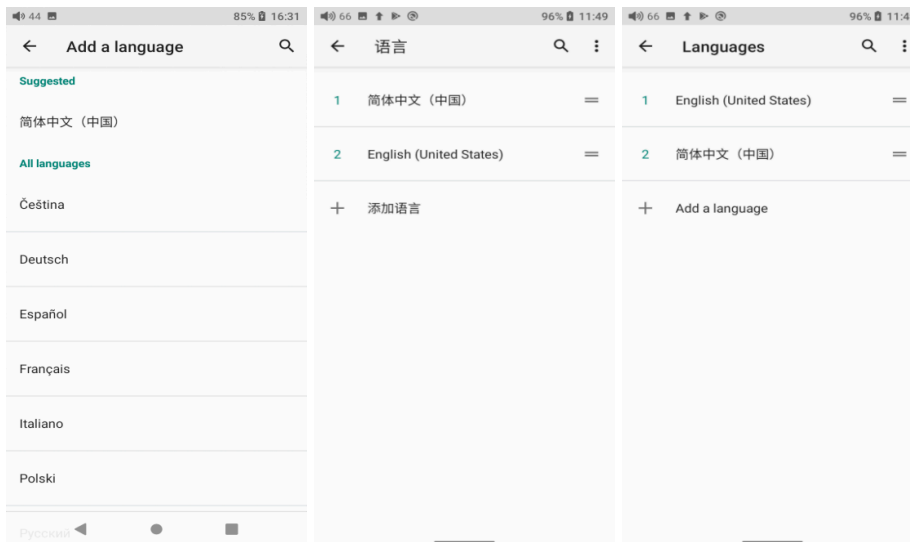
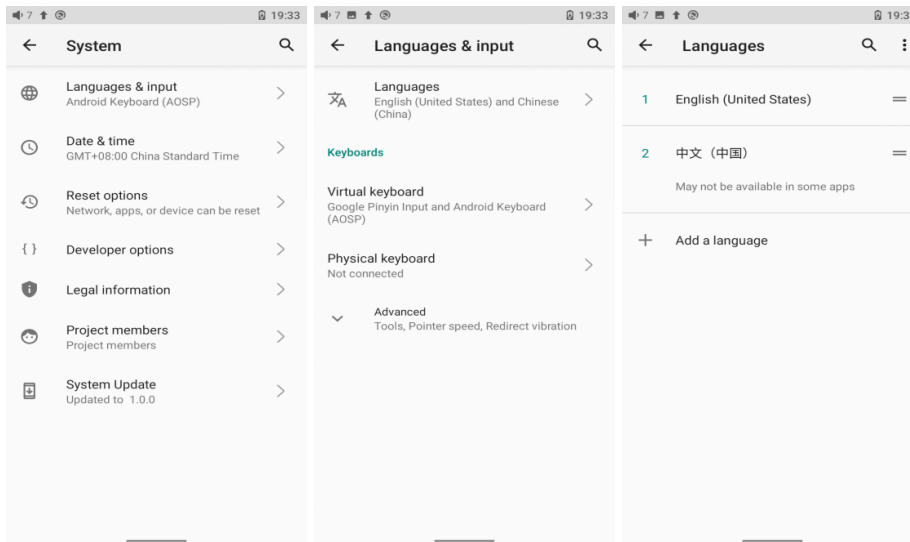

## 6. How to enable the USB DAC function?

### MAC system

For Mac computers, the M17 runs driver-free.



## Windows system

For Windows computers, please make the settings as the followed steps.

- 1) Install the FiiO DAC driver on the computer first.
- 2) Switch the working mode of the M17 to USB DAC mode on the drop-down menu or go to Settings->Mode choose menu to enter the USB DAC mode.
- 3) Connect the M17 to the computer by the USB port. Select the M17 as the audio input both in the computer and the music app, so it can work.

### Notes:

*When in the USB DAC mode, the M17 does not support Bluetooth transmitting.*

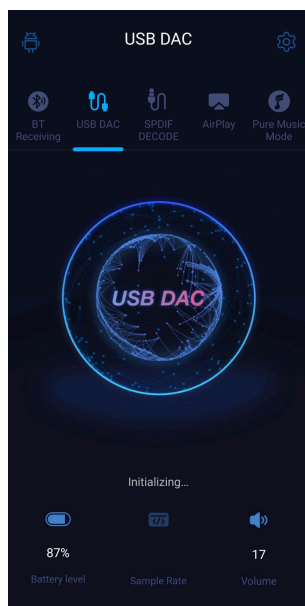

## 7. How to use the M17 as a Bluetooth transmitter?

### Bluetooth transmitter instructions

When being a Bluetooth transmitter connecting to new Bluetooth devices (such as Bluetooth headphones, Bluetooth speakers), the M17 needs to pair with the Bluetooth device first. Here are the steps.

1. Go to the Settings->Bluetooth menu to turn on the Bluetooth function.
2. Make the Bluetooth receiving device, such as Bluetooth earphones, enter the pairing state. (Please refer to the user manual of the Bluetooth receiving device about how to enter the pairing state.)
3. Go to the Bluetooth device list of the M17->Pair a new device to complete the connection.
4. Tap the intended device to start the connection. Successfully connected devices will be displayed on the list of Available media devices with an "Active" prompt.

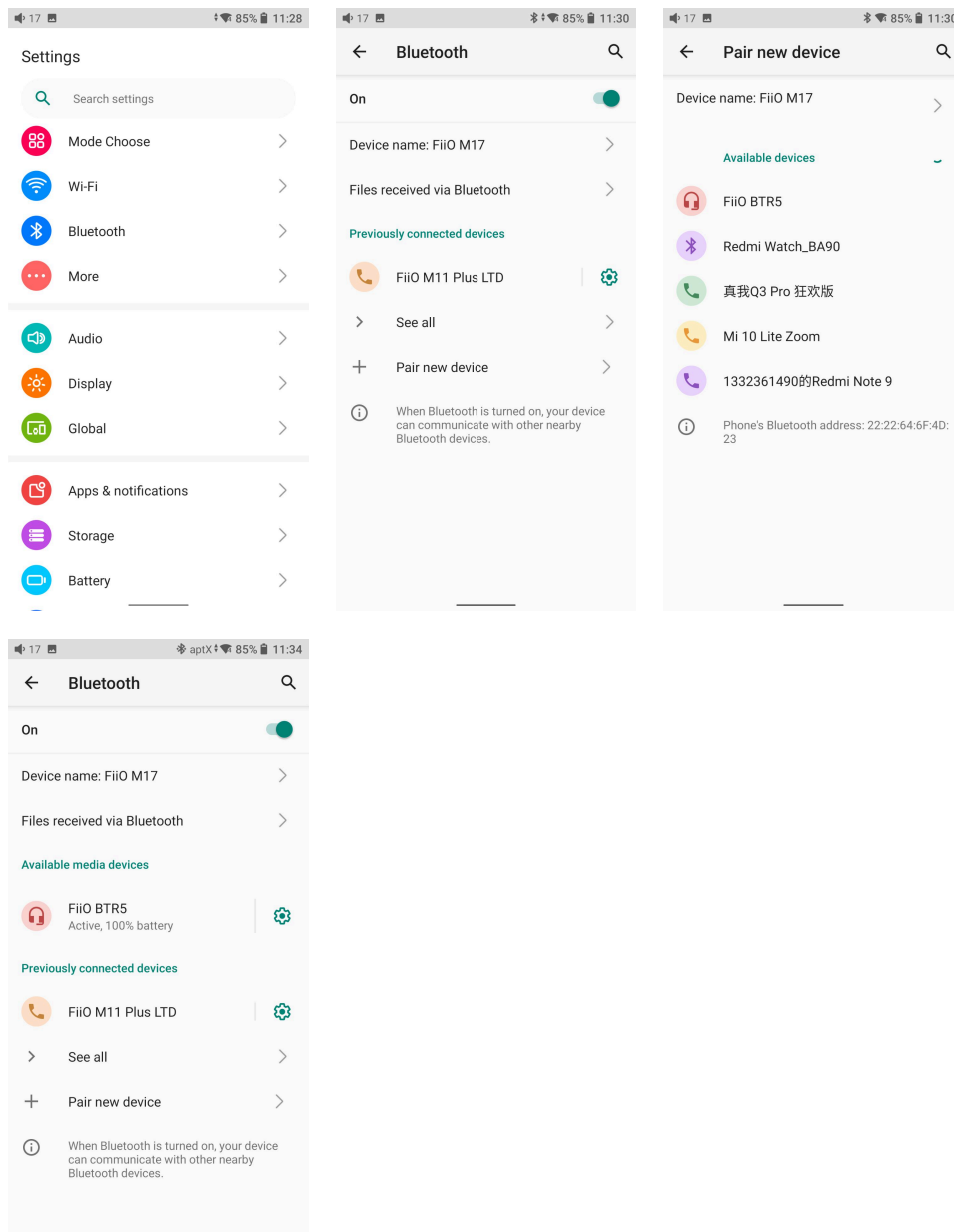

What can be done if the M17 fails to connect to Bluetooth earphones?

If it fails to connect to Bluetooth earphones for the first time, please make sure the earphones are in the pairing state (the connection will fail if the earphones are under reconnecting state for the first-time connection). Go to the Bluetooth menu of the M17 to start the connection.

What Bluetooth codecs does the M17 support? And how to switch the Bluetooth codecs?

The M17 supports LDAC, aptX-HD, aptX, AAC and SBC which can be switched on Settings->Audio->Wireless playback quality menu.

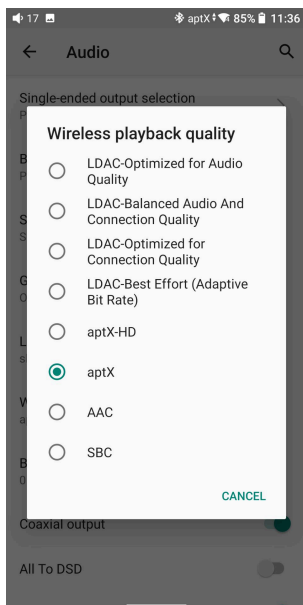

What can be done if the volume is too low when the M17 is connected to AirPods?

Go to Settings->About phone, and continuously tap the "Build number" 7 times. Go back to Settings->System->Developer options menu to turn off the "Disable absolute volume".

Disconnect and reconnect the two devices through Bluetooth.

## 8. What power supply adapter is suggested to charge the M17?

1. Supports QC4.0, QC3.0, QC2.0, PD2.0, PD3.0 and other fast charging protocols, if the adapter does not support the above protocol, it generally will not trigger the fast charge function. It is recommended to use 5V 1-2A adapters for non-fast charging adapters. After setting to UAC mode, inserting USB fast charging will not make it enter the fast charging mode.
2. Supports a 5.5mm diameter DC round head 12VDC charger to power the whole machine.
3. When the DC voltage is too high and exceeds 16V, the system will automatically disconnect the DC power supply.
4. When the DC and USB3.0 are plugged in at the same time, the system will detect whether the USB is a Fast charge, it will use USB to charge the battery if the USB is a fast charge.
5. When the M17 is in UAC mode, it will not enter fast charging mode.

## Introduction to system settings menu

Here is the system settings menu of the M17

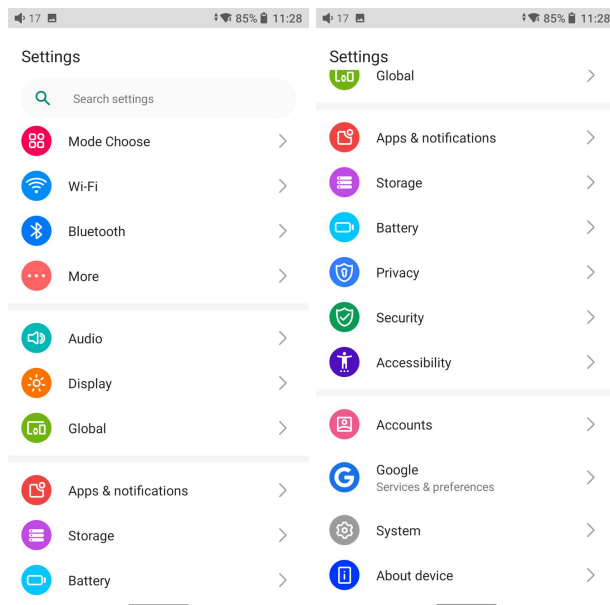

# 1. WiFi

The M17 supports a WiFi connection of 2.4/5G dual-band for music resources access. Here are the steps to connect the M17 to a new WiFi device.

- 1) In the settings menu of the M17, tap "WiFi".
- 2) Turn it on. The M17 will automatically search for and list available WiFi devices nearby.
- 3) Tap the intended WiFi device and connect them.

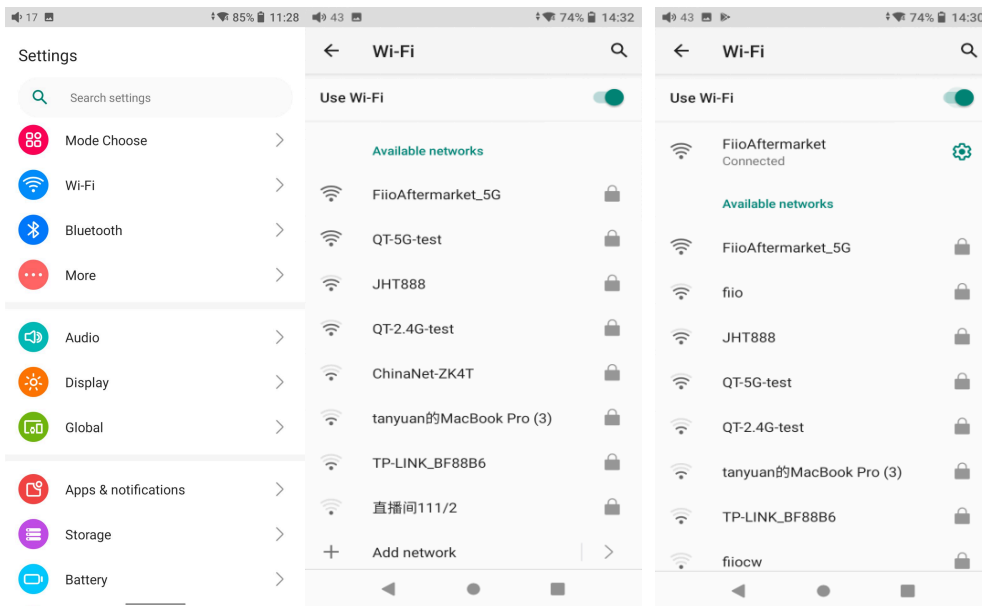

# 2. Bluetooth

The M17 supports lots of Bluetooth codecs for both transmission and reception, allowing for rich wireless connections.

## Bluetooth transmitter instructions

When being a Bluetooth transmitter connecting to new Bluetooth devices (such as Bluetooth headphones, Bluetooth speakers), the M17 needs to pair with the Bluetooth device first.

Here are the steps.

1. Go to the Settings->Bluetooth menu to turn on the Bluetooth function.
2. Make the Bluetooth receiving device, such as Bluetooth earphones, enter the pairing state. (Please refer to the user manual of the Bluetooth receiving device about how to enter the pairing state.)
3. Go to the Bluetooth device list of the M17->Pair a new device to complete the connection.

4. Tap the intended device to start the connection. Successfully connected devices will be displayed on the list of Available media devices with an "Active" prompt.

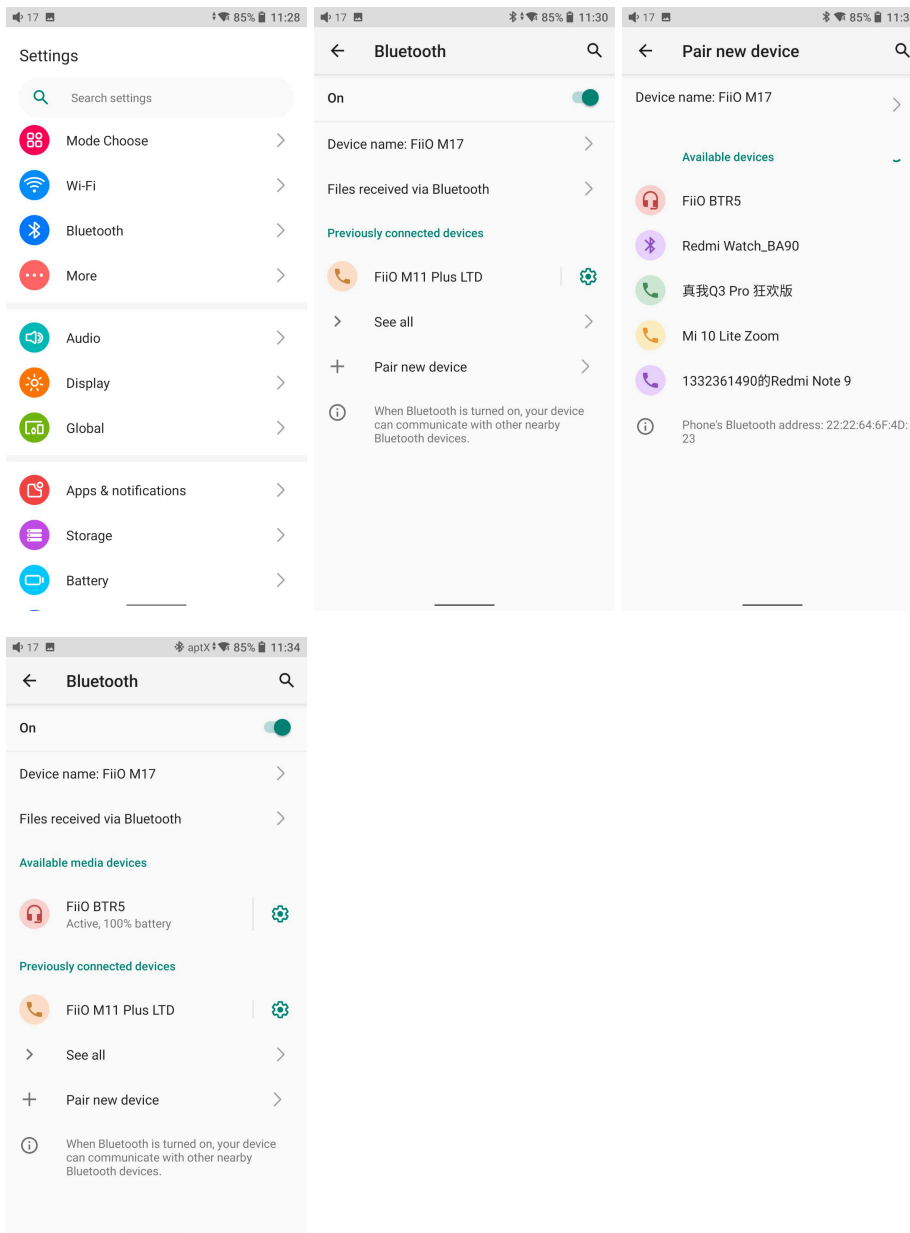

Before connecting to a Bluetooth device, you can select the Bluetooth codec you like in the M17. Here are the steps.

1) Go to the Settings->Audio menu.

2) Tap Wireless playback quality-> choose the intended Bluetooth codec.

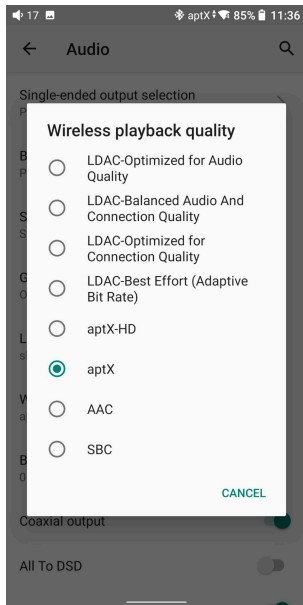

Note:

*When the Bluetooth is enabled, the M17 will preferentially connect to the last-connected available Bluetooth devices.*

## Bluetooth Receiving mode

1. When switching to the Bluetooth Receiving mode for the first time, the M17 will automatically enter the pairing state. The next time it enters Bluetooth Receiving mode, it will reconnect to the last connected device automatically.

2. Go to the Bluetooth transmitting list of the mobile phone, and tap the M17 to complete the connection.

-Force the device to enter pairing mode: Hold the Play/Pause button for about 3 seconds.

-Manually enter reconnecting mode: Short press the Play/Pause button when not in pairing mode.

-Clear current pairing: Hold the Previous and Next track buttons at the same time for about 3 seconds.

-Play/Pause: Short press the Play/Pause button.

-Previous/Next track: Short press the Previous/Next track button.

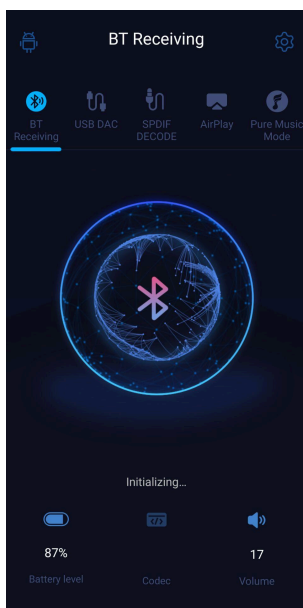



### 3. Audio

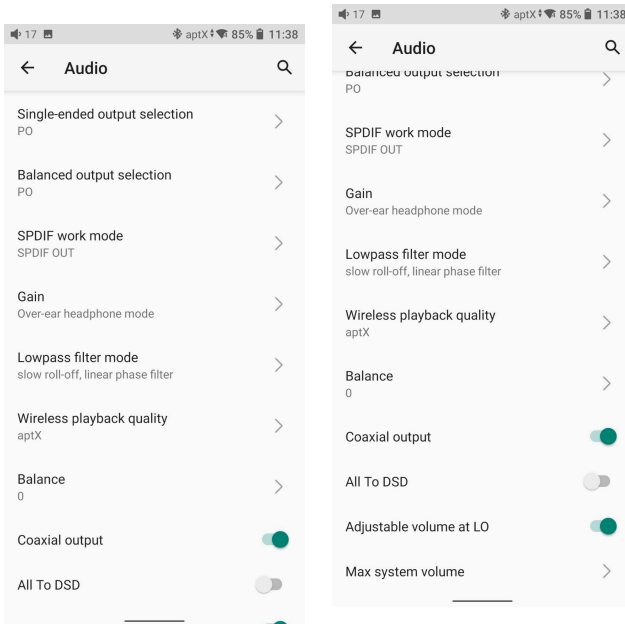

#### Output selection

Both PO and LO are available for 3.5mm and 4.4mm outputs.

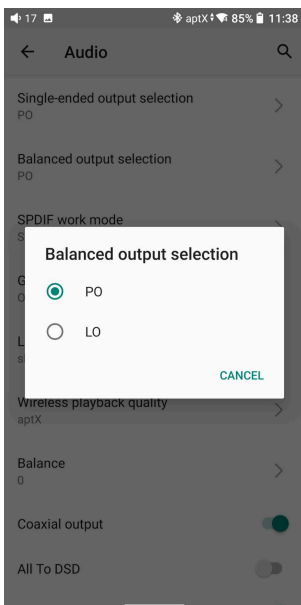

#### Single-ended output selection

PO (Power output), generally used when connecting to earphones and speakers

LO (Line out), generally used when connecting to power amplifiers

### Balanced Output selection

PO (Power output), generally used when connecting to earphones and speakers with balanced input

LO (Line out), generally used when connecting to power amplifiers with balanced input

### SPDIF work mode

Switch the work mode of the coaxial in/out port

SPDIF IN: Coaxial decoding mode, M17 is used as a coaxial decoder.

SPDIF OUT: The M17 output to the coaxial decoder for decoding. (will not use M17's DAC for decoding)

### Gain

There are 4 levels, High, Medium Low and Over-ear headphone mode, corresponding to 4 levels of output voltages. You can select different Gains according to the earphones used.

When the switch is set to DC and the DC power adapter is inserted, you could switch to the hidden Enhanced Over-ear headphone mode.

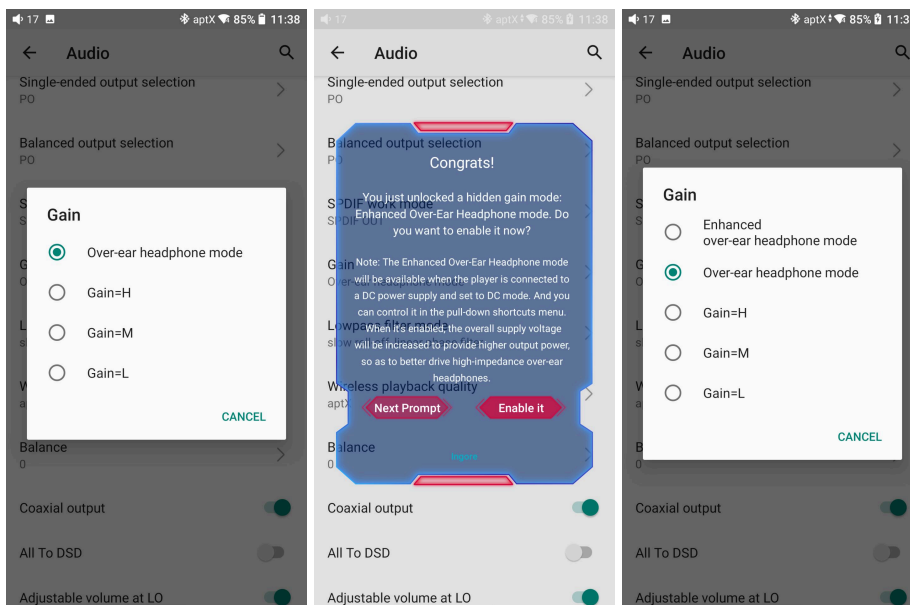

## Lowpass filters

There are 7 different filters (internal configuration of the ES9038PRO) built in the M17 for your preference.

Filters are the sound effects born with the chip, which only has slight adjustments for the sound. Here are some introductions to different filters. These are only for reference since actual listening also has something to do with the matched device.

- 1) fast roll-off, linear phase filter: Most Common filter with clean suppression and high rejection, best for music with high transients. Provides crisp clean highs
- 2) slow roll-off, linear phase filter: coherent and clear sounds, positioned near the middle. It is suitable for classical music.
- 3) fast roll-off, minimum phase filter: minimal Pre- Ringing, preferred for Imaging and soundstage. No aliasing in frequency domain. Stronger bass than Linear Phase, clean highs
- 4) slow roll-off, minimum phase filter: non-symmetrical filter designed to minimize pre-ringing. Strong punchy bass with good transient attacks
- 5) apodizing fast roll-off, linear phase filter: Version of Linear phase fast roll-off filter optimized to improve pre-ringing.
- 6) hybrid fast roll-off, minimum phase filter: Combination of Linear-phase and Minimum-phase. Fast transient attack, strong punchy bass, crisp highs.
- 7) brickwall filter: one of the earliest designs, intended for highest suppression possible, with high delay and pre-ringing.

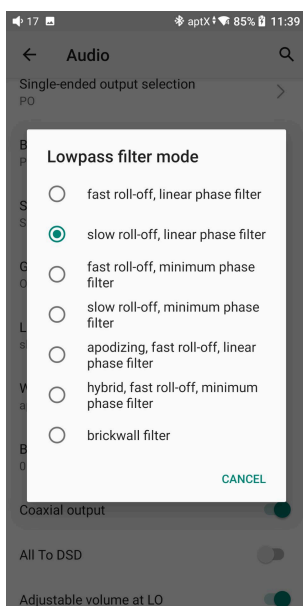

## Wireless playback quality

The Bluetooth transmission takes the highest codec by default. You can choose the highest codec supported for the Bluetooth connection by this option.

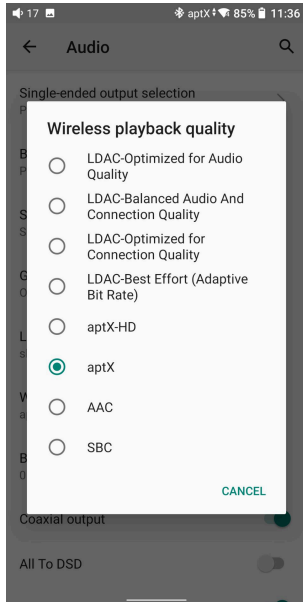

## Balance

If there is any imbalance between the left and right channels when playing music, you can adjust the channel balance here. It supports L20-R20 adjustment.

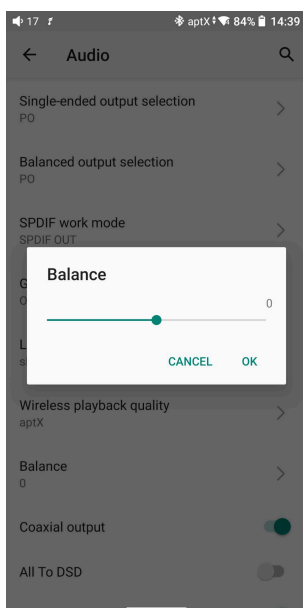

## Coaxial output

After switching the SPDIF work mode to SPDIF OUT, please turn on this switch before using the coaxial output function.

## All To DSD

When the All To DSD function is turned on, the PCM signals will be converted to DSD for output with sound quality further improved.

**【Principle】**All To DSD is mainly about switching digital signals from PCM to DSD format. So when making digital-to-analog conversion, it can use DSD format, enriching music styles with clearer and natural sound quality. In addition, since the lowest format of the DSD is DSD64, i.e. 4 times of the 44.1k/16bit (just looking at the data size), the All To DSD function is upsampling the 44.1k/16bit audio signals. Third-party apps also support All To DSD.

**【Notes】** When the All To DSD function is turned on, the CPU will consume more power, which will shorten the playtime of the M17 with obvious heating on the body.

During the process of using, if you notice that the total battery life is much shorter than that written on the specification table on our website, please check if the All To DSD function is turning on. It is suggested to turn off the All To DSD function and follow the provided test conditions to check the battery life of the M17 again.

## Adjustable volume at LO

When it is turned on, the volume will be adjustable in LO mode. If it is turned off, the volume will be fixed as maximum.

## Max system volume

When the max system volume is set, the system volume will not go higher than the set volume.

## 4. Display

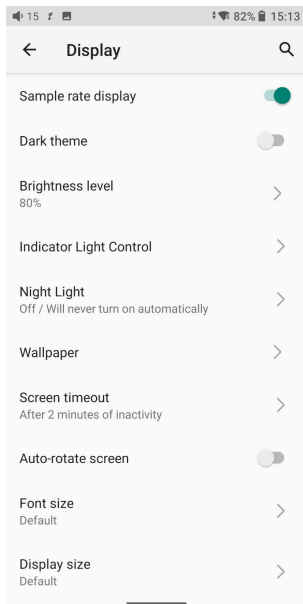

The display settings consist of Sample rate display, Dark theme, Brightness level, Indicator light control, Night light, Wallpaper, Screen timeout, Auto-rotate screen, Font size, Display size, Screen saver and lock screen display. The following are detailed descriptions of some common items.

### Sample rate display

With it turned on, the sample rate of the currently playing song will be displayed.

### Indicator light control

The brightness level and light color of the volume knob indicator light and the side ambient light under working and charging status can be set in this menu.

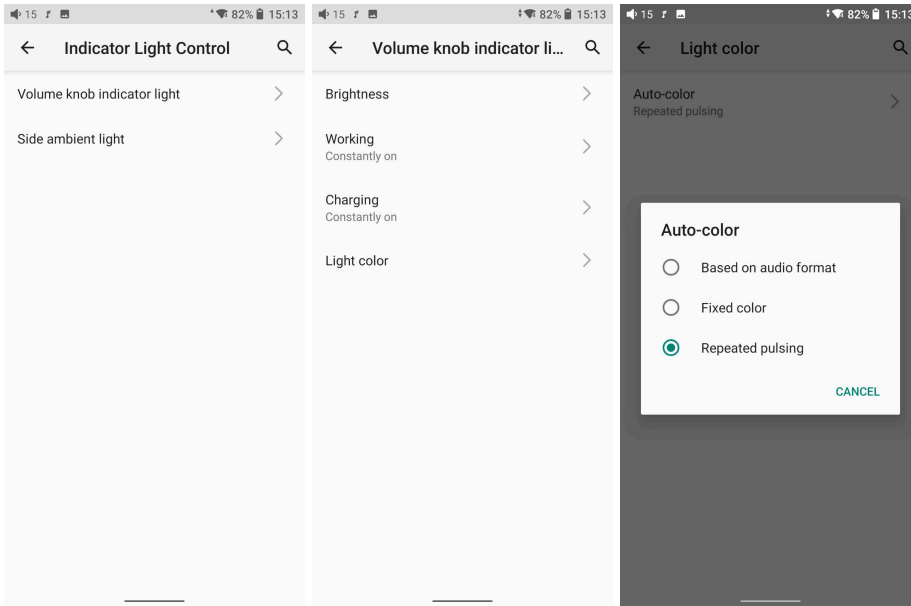

## Screen timeout

This option is to set the time when the device will enter sleeping mode after inactivity. The device will enter low power consumption mode after 10 minutes of sleeping. Short press the Power/Lockscreen button to wake it up.

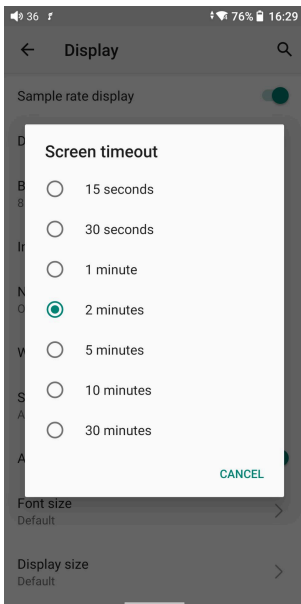

## Night light

The color of the display screen will be adjusted in amber under Night light mode. You could enable the Night light mode at a custom time, or from sunset to sunrise.

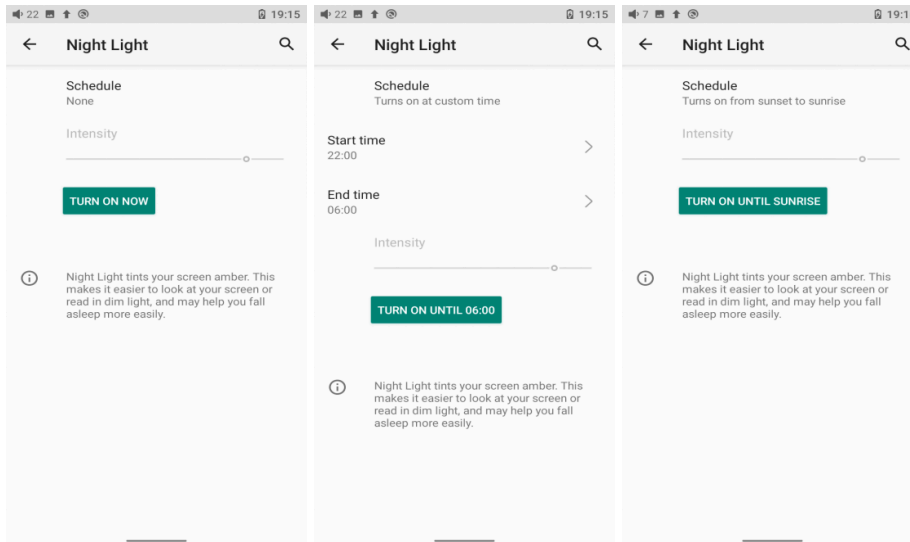

## Auto-rotate screen

With it turned on, the screen can be automatically rotated like a smartphone thanks to the gyroscope

## Font size

There are four standards available, which respectively are small, default, large and largest.



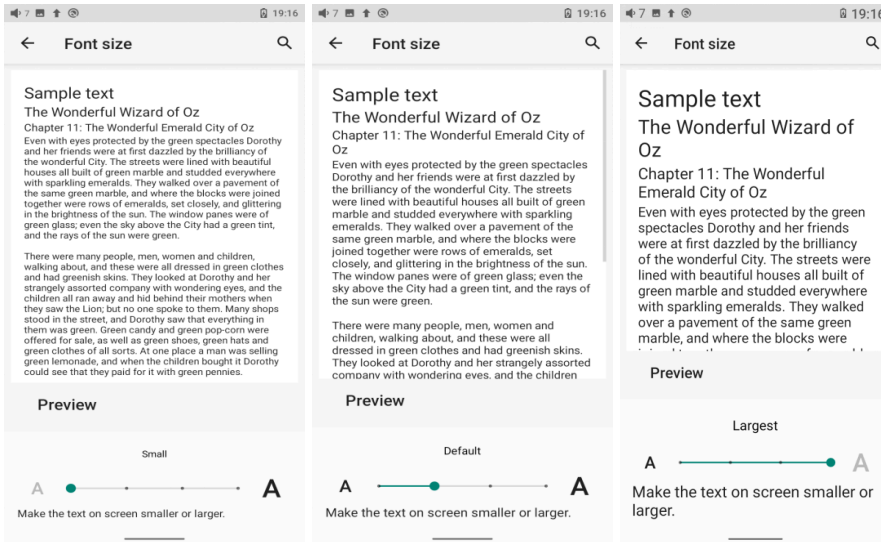

## Display size

The display size corresponds to the size of the icons and texts displayed on the screen.

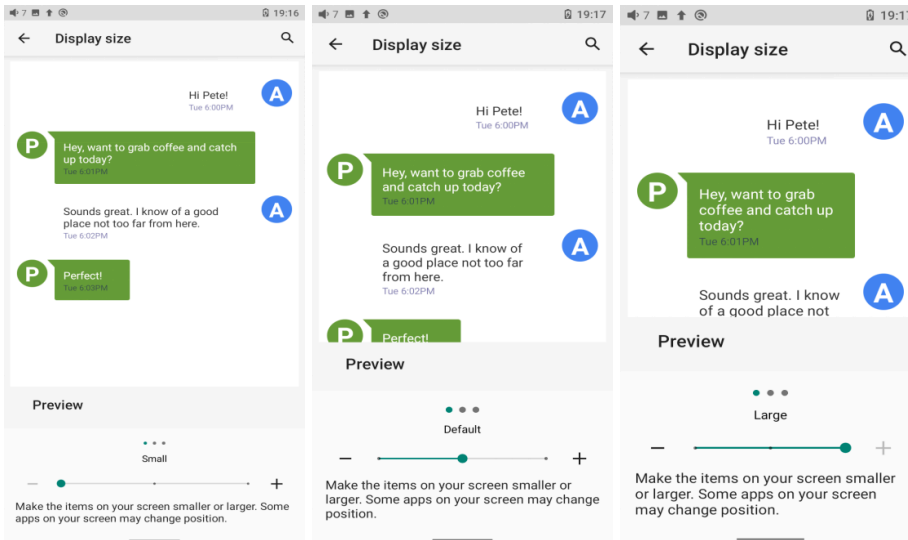

## 5. Global

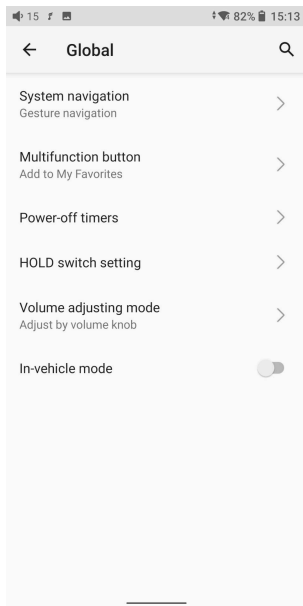

### System navigation

There are 3 navigation ways for your preference and needs, including Gesture navigation, 2-button navigation and 3-button navigation.

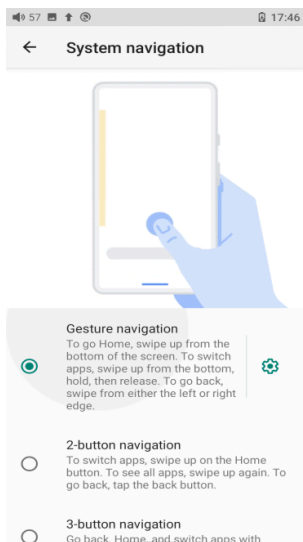

## Gesture controls introduction

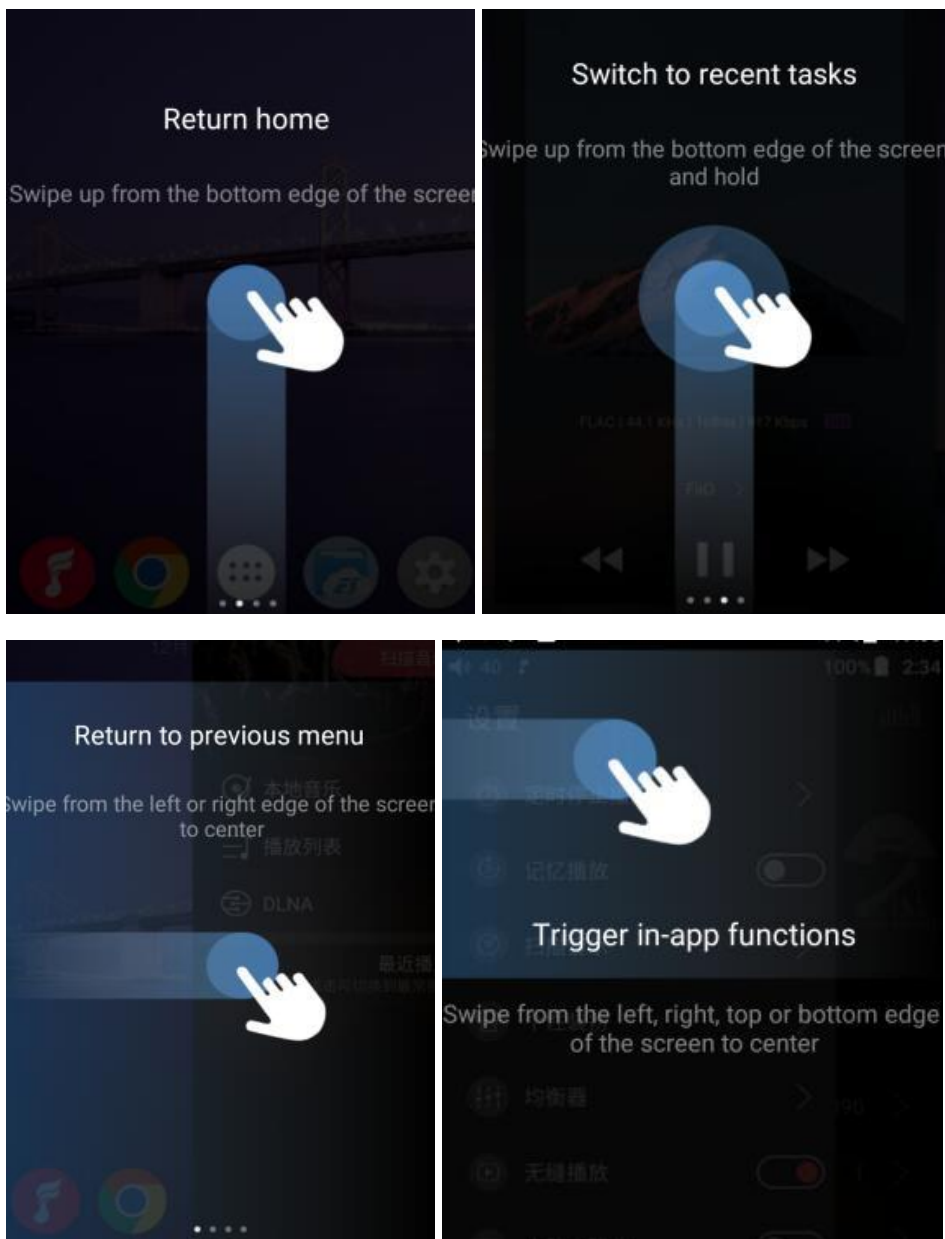

## Multi-function button

To assign the function of the multifunction button on the left side.

You can customize the multi-function buttons to select a frequently used function for one-button quick start.

For example, you can set the button to add to favorites, random play, play/pause, switch filter, switch equalizer, delete the currently playing song, switch to USB DAC mode, switch to Bluetooth mode, no function, etc.

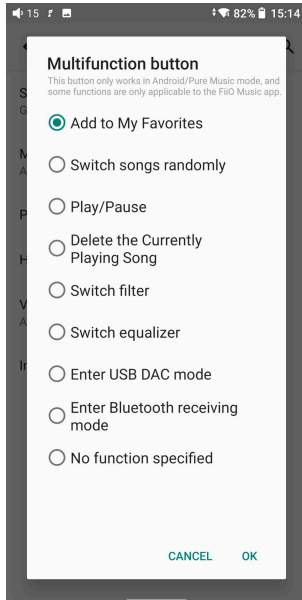

## Power-off timer

There are two types of timer, Sleep and Idle poweroff.

### Sleep

The device will automatically shut down when the time reaches the set value. It can be set to any integer value between 0 and 120 minutes. (Note that if it is turned OFF, the sleep shutdown function will be disabled.)

### Idle poweroff

If the device is not working without any operation, it will automatically turn off once the timer reaches the set value. It can be set to any integer value between 0 and 50 minutes. (Note that if it is turned OFF, the idle shutdown function will be disabled.)

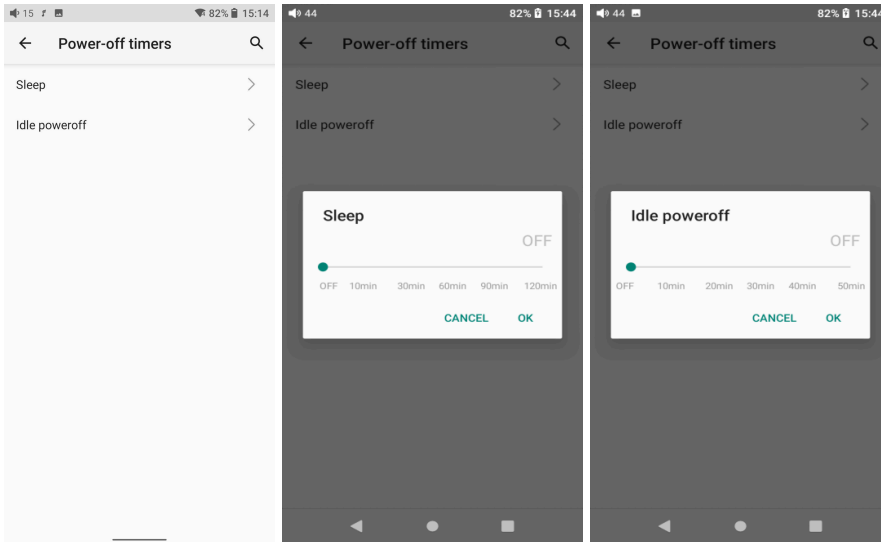

## Hold switch setting

If the HOLD switch is turned on, you can enable/disable any buttons or the volume knob.

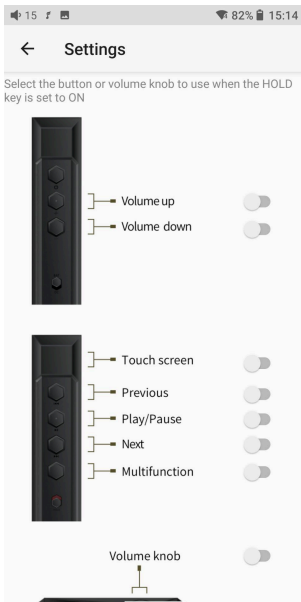

## Volume adjusting mode

The M17 uses the volume knob for adjusting the volume by default. The volume button could not adjust the volume at that time. You could switch this option to 'Adjust by volume button' and the volume button could adjust the volume now. Please select the option according to your need.

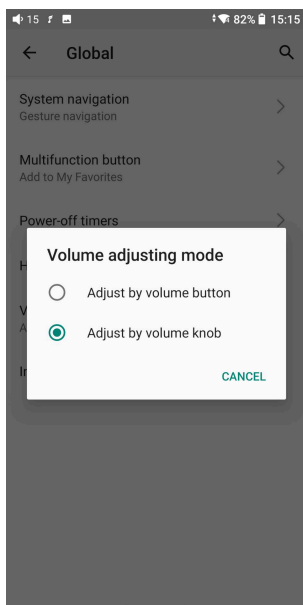

## In-vehicle mode

**【Principle】**After turning on the In-vehicle mode, you can connect the USB 3.0 port of M17 to the on-board USB port. And the M17 will power on automatically and switch to the In-vehicle mode screen when the vehicle engine starts, and power off automatically when the vehicle engine stops.

**【How to set】**Go to Settings->Global->In-vehicle mode, or the drop-down menu to turn on the in-vehicle mode.

(Some onboard USB ports may encounter interruptions when connecting to the M17, in which case you can try to use FiiO's USB isolator, the LA-UA1, to fix the problem.)

\*The in-vehicle mode will only work for the USB 3.0 port in the M17.

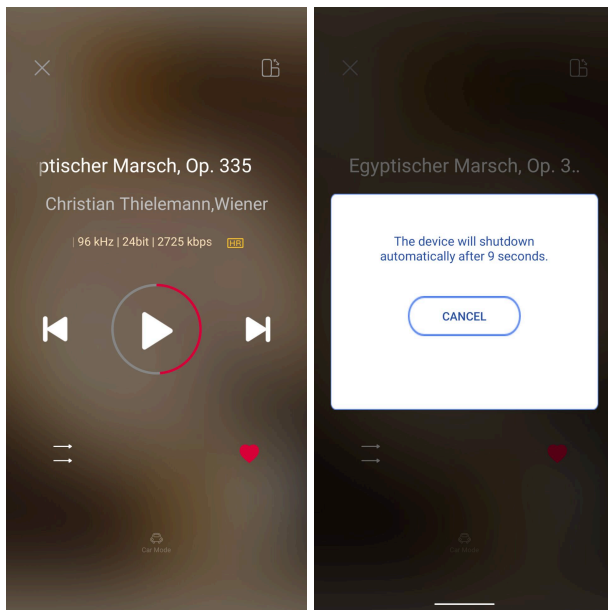

## 6. System

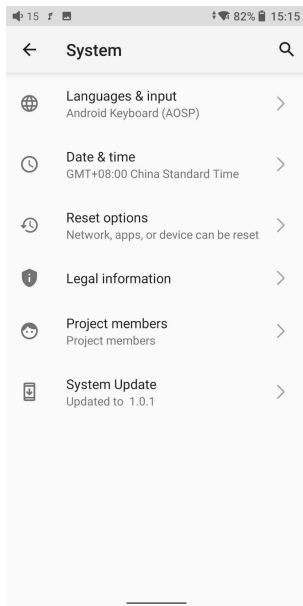

### Languages & input

The first time the device starts up, you can choose an appropriate language from the prompt.

If you want to choose other languages, you can go to the Settings menu. Here are the instructions.

- 1) Go to the menu of Settings-> System-> Languages & input-> Languages;
- 2) In the Languages page, tap Add a language;
- 3) Select a language;



4) After selecting the language, hold the “=” icon on the right side of the target language and drag it to the top, so to successfully select the language.

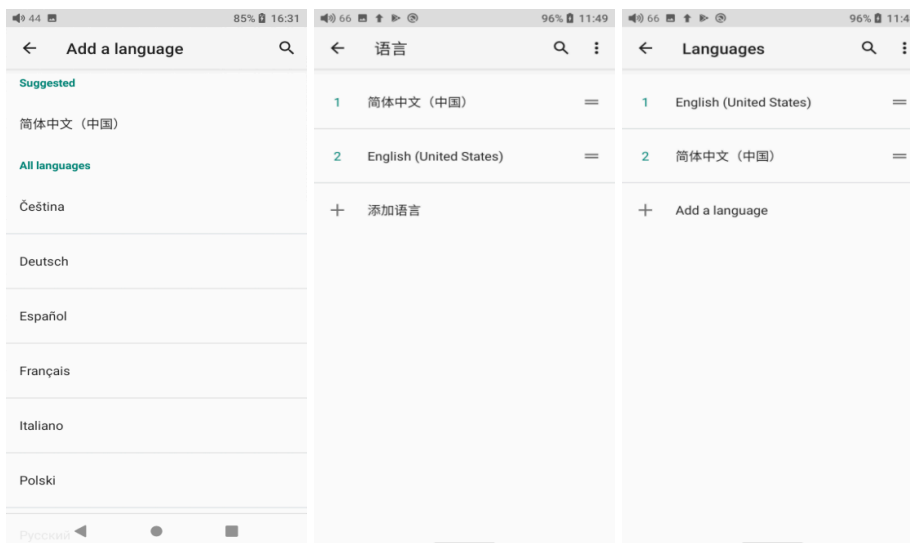
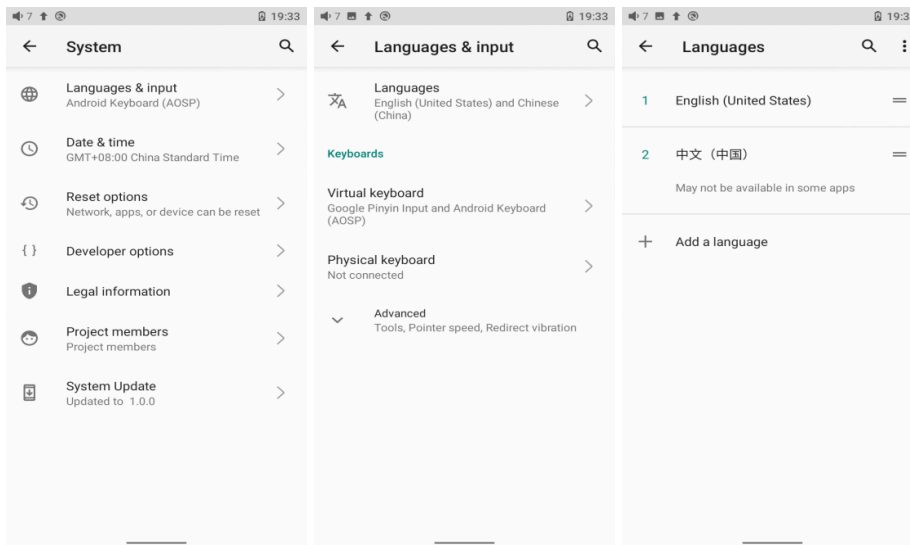

## Reset options

"Reset WiFi, mobile & Bluetooth" will reset all network settings, including WiFi and Bluetooth.

"Reset app preferences" will reset all preferences including the items shown in the following picture.

"Erase all data", i.e. factory reset, will erase all data from your device's internal storage, and all settings will be reset to default. **Please back up your important data before resetting.**

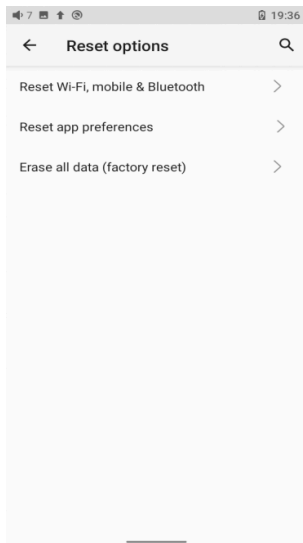

## FiiO Music APP

The M17 has built in the FiiO Music app, a professional audio playing application specially developing for Android-based systems and flagship-grade music players.

### 1. Homepage

FiiO Music APP will enter the homepage once it starts up as shown below.

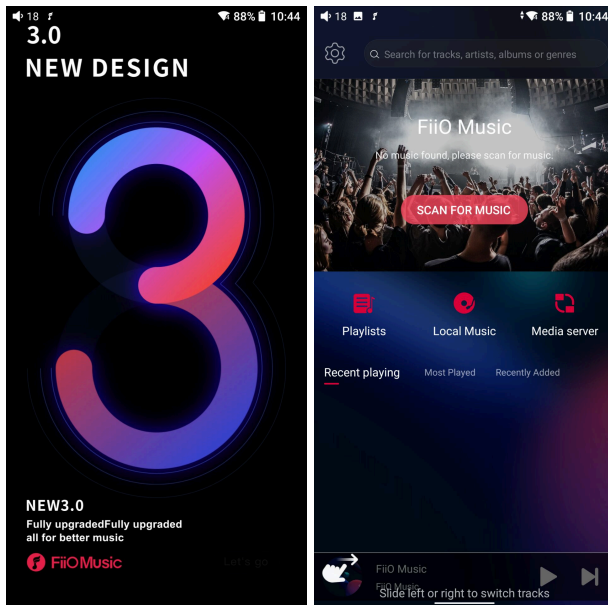

- 1) Settings icon: tap the icon to enter the settings page.
- 2) Playing menu: press the icon to enter the playing page.
- 3) Recently played: the list of recently played songs will be presented chronologically.
- 4) Frequently played: the list of recently played songs will be presented based on playing frequencies.
- 5) Recently added: a list of recently added songs will be presented chronologically.

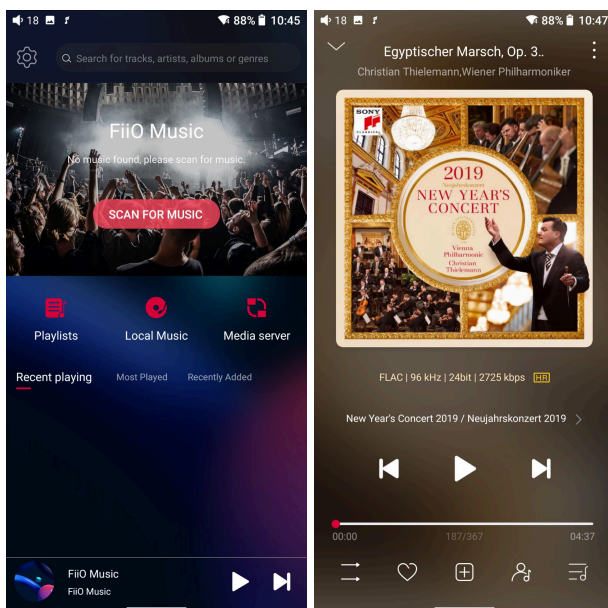

## 2. Quickly locate all songs

Slide the screen with your finger on the letter bar on the right side. A quick search icon will show up in the middle of the screen. Sliding to corresponding initials and relieving your finger, it will directly jump to the songs starting with the initial you have chosen.



## 3. All songs menu

Tap the icon at the right corner of each track to wake up the hidden menu. Then tap the icon in the menu to perform corresponding operations.

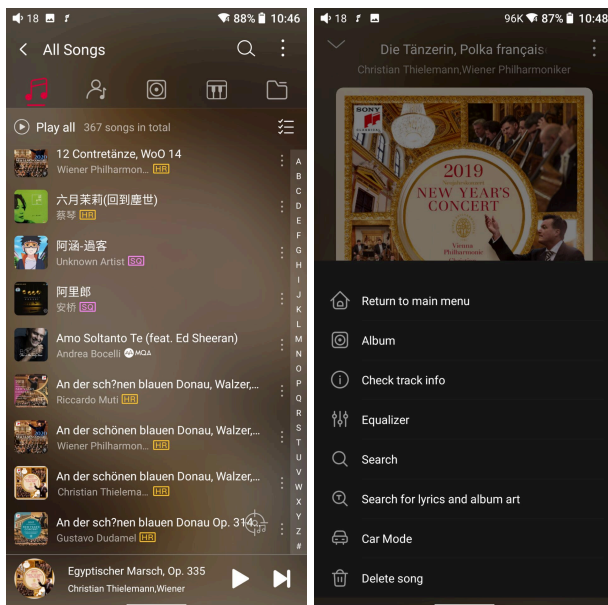

Tapping the hidden menu on the upper right corner of the screen, you can decide the way of songs sorted as Sort by date added, Sort by filename and Sort by the first letter.

Bulk management: Play music, WiFi music transfer, Add to my favorites, Add to playlists, Delete selected, and Exit bulk management.

## 4. Playing page

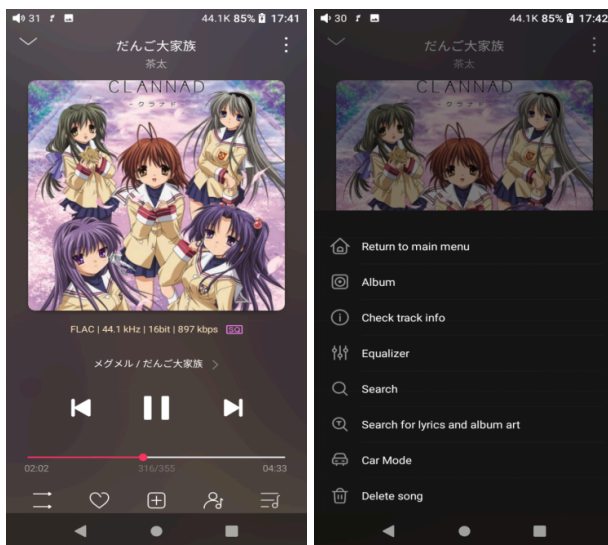

Switch page: by tapping the middle of the album cover, it will switch pages between the album cover and lyrics circularly. Swipe left and right to switch songs.

Adjust volume: slide up/down on the volume touch panel or press the physical button to increase/decrease the volume.

Playing progress: slide left and right on the progress bar below the album cover to quickly adjust the progress of the now playing song.

jump to the corresponding part of the track now playing;

*Notes: on the lyrics display page, you can adjust the song progress, lyrics timeline and font size.*

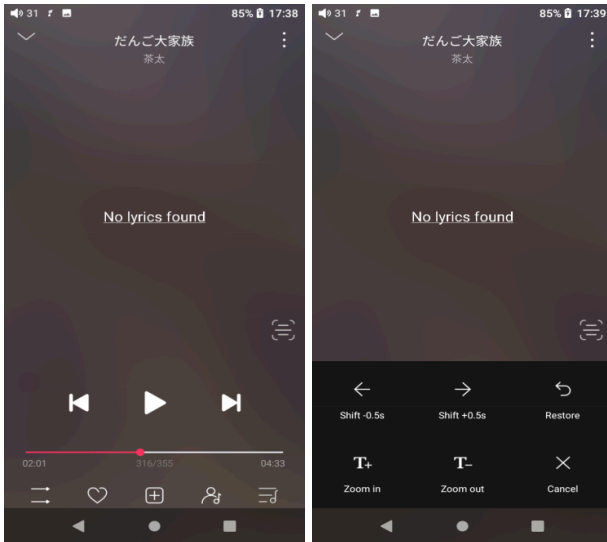

## 5. Equalizer

FiiO Music has a built-in equalizer, on which you can straightly choose the preset EQ for listening, or adjust it through the 10 frequency bands within 20Hz~20kHz from -12 to +12 dB, fully meeting personal music tastes.

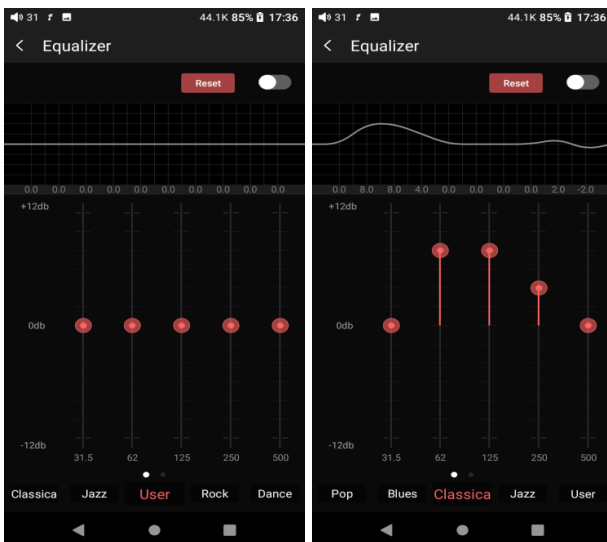

**Choose preset EQ:** swipe left or right on the bottom of the screen to switch equalizer.

**Customized EQ:** drag the corresponding frequency band up and down to slightly adjust the EQ curve (on the bands page, switch left and right to change the option). Successively adjusting the EQ in need, it will immediately take effect.

**Reset EQ:** Tap the Reset button at the upper right corner to reset the present EQ.

*Notes: if the system is reset to factory mode, all EQ settings will be reset to default.*

## 6. UV meter

There is a newly added UV meter (audio meter) with a dB threshold and dynamic pointer displayed. Closing to the red threshold of 0dB means audio distortion.

How to enable it: tap the song cover on the now playing page to enter the UV meter displaying page.



## 7. Frequency spectrum playing page

There is a newly added frequency spectrum mode in the now playing page, which has 3 built-in spectrum effects available. Besides, users can self-define Full screen display or Original display for the spectrum mode.

How to enable it: go to the Settings menu in FiiO Music app->Theme->Now playing page. Choose Spectrum display.

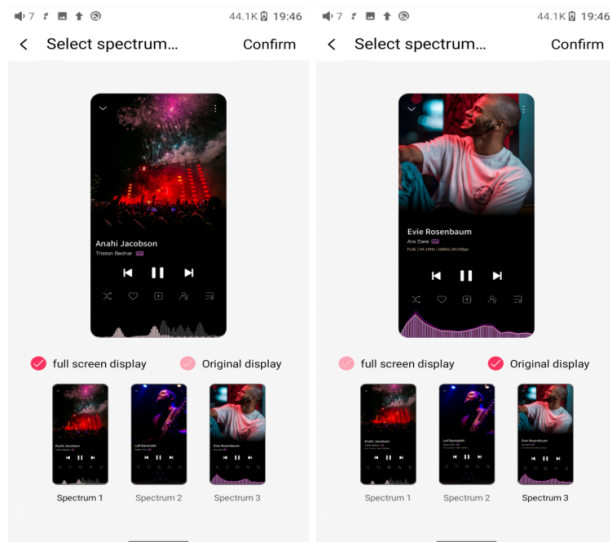

Square cover and large cover:



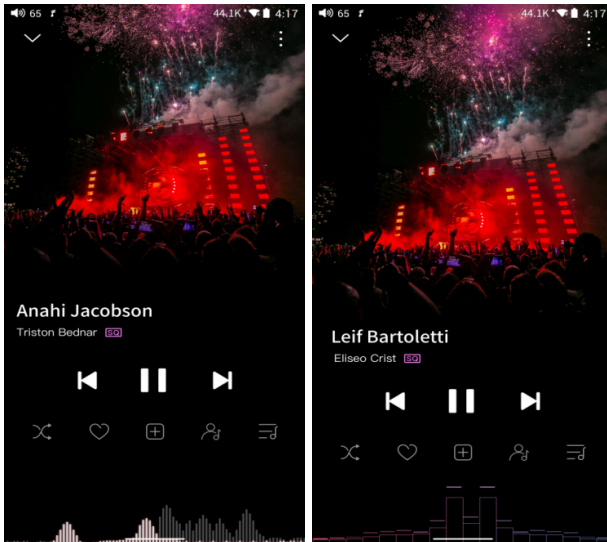

*FiiO Music app keeps upgrading and maintaining. For the newest instruction, please visit our official forum:*

*<https://forum.fii.com/note/showNoteContent.do?id=202105071626425774349&tid=17>*

## Instructions for commonly-used functions

### 1. Screenshot

The M17 supports screenshot: swipe down the screen with 3 fingers, or hold the power and volume down button at the same time.

The screenshot is stored in FiiO M17\Files\Internal storage\Pictures\Screenshots.

### 2. USB Audio digital output

The M17 supports connecting to external decoders (USB Audio). Follow the steps to enable it.

1) In the FiiO Music app, turn on the USB output

2) Use an OTG adapter cable to connect the M17 to the external decoder.

3) Starting up the FiiO Music app or any music app, the M17 can work as a USB digital device.

It supports most decoders on the market. For those unsupported, please turn off the USB output in the FiiO Music app, or unplug and re-plug the USB device after exiting the FiiO Music app to try playing again.

### 3. FiiO Link Bluetooth control

There are mainly 3 steps.

1) On the FiiO Music app of the M17, Settings->FiiO Link-> ⋮ (on the upper right corner of the display), choose Bluetooth as the Server.

2) Connect the M17 to the mobile phone through Bluetooth.

3) On the FiiO Music app of the mobile phone, Settings->FiiO Link-> ⋮ (on the upper right corner of the display), choose Bluetooth as the Client.

*Notes: iPhones only support FiiO Link WiFi control but not Bluetooth.*

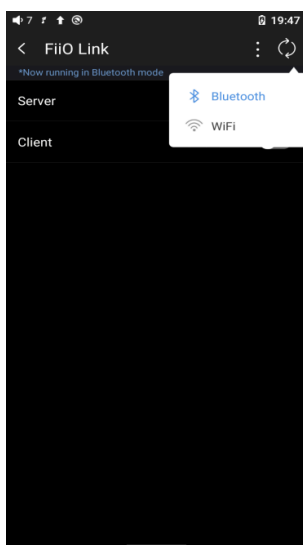

## 4. FiiO Link Wifi control

There are mainly 3 steps.

1. Make sure the M17 and your mobile phone are connected to the same WiFi network.
2. On the FiiO Music app of the M17, Settings->FiiO Link-> ⋮ (on the upper right corner of the display), choosing WiFi as the Server. Now an IP address will show up.
3. On the FiiO Music app of the mobile phone, Settings->FiiO Link-> ⋮ (on the upper right corner of the display), choosing WiFi as the Client. Input the IP address in the pop-up dialog and complete the connection.

*Notes: iPhones only support FiiO Link WiFi control but not Bluetooth.*

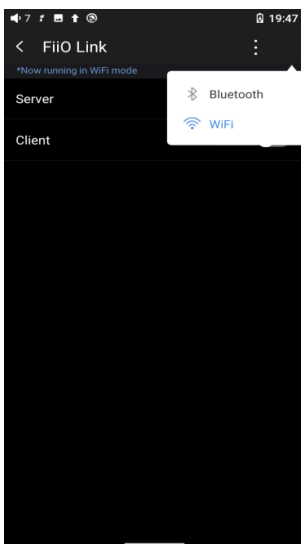

## 5. How to use the DLNA function?

The DLNA function means the M17 can read and receive music files stored on the device (name it Device A) which supports DLNA function through WiFi.

1. Make sure the M17 and Device A are connected to the same WiFi network.

2. On the FiiO Music app of the M17, tap DLNA on the main menu and search for Device A to play music of it.

Notes: If there are any devices that cannot use the DLNA function, please give us feedback for further analysis. FiiO Music app does not support music transmission at present but only music reception. We will consider adding the transmission function later.

## 6. How to use the coaxial function of M17?

M17 coaxial port supports output and input of coaxial signals.

Coaxial input:

Coaxial decoding mode, M17 is used as a coaxial decoder.

1. Switch the SPDIF work mode of M17 to SPDIF IN mode from Settings-Audio or go to the drop-down or Settings menu of the M17, and choose the working mode as SPDIF RX mode.
2. Use coaxial cable to connect M17 and coaxial output device;
3. Connect the headphone to the M17 to use it.

Coaxial output:

this function will not use M17's DAC for decoding, but output to the coaxial decoder for decoding.

1. Switch the SPDIF work mode of M17 to SPDIF OUT mode from Settings-Audio;

And please turn on 'Coaxial output' option before using the coaxial output function.

2. Use a coaxial cable with one side connected to M17 and the other side to a coaxial decoder;

3. When you use the FiiO Music, DSD OUT should give priority to DoP. If the coaxial decoder doesn't support it, please select D2P mode.

## 7. How to make M17 enter enhanced over-ear headphones mode?

1. Connect M17 with the original power adapter of M17;
2. Switch the BAT/DC switch on the side of M17 to DC mode to enter the hidden mode(enhanced over-ear headphones mode).

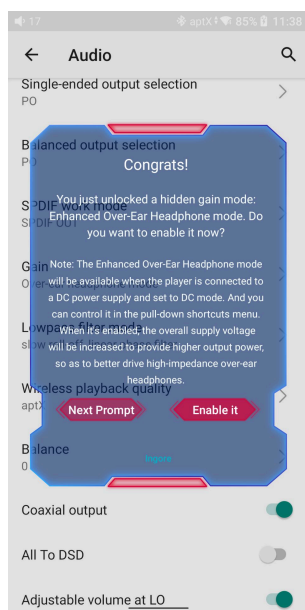

## 8. What can be done if I forget my password? How to enter recovery mode?

The device needs to be reset from recovery mode if you forget the password.

Turn off the device first. Hold the play/pause button then plug a USB cable into the USB 3.0 port for power supply. It will enter recovery mode after turning on. On the display, choose "Wipe data/factory reset->Yes. You could switch the option via the volume +/- or play/pause buttons. Then choose "Reboot system now" by pressing the power button to restart the device.

## **9. How to use the wifi transfer function in M17 ?**

1. Make sure this device and your mobile phone are connected to the same WiFi network.
2. Enter the FiiO Music APP(player's)-setting-FiiO Link- three dots icon at the top right, switch to WiFi option. Then switch on the Server option. And you will see a IP address at that time.
3. Install the latest FiiO Music APP in your mobile phone.

For Android device:

Enter the FiiO Music APP-setting-FiiO Link- three dots icon at the top right, switch to WiFi option. Then switch on the Client option.

For iOS device :

Enter the FiiO Music APP-setting-FiiO Link

4. Input the ip address in the pop up dialog.
5. FiiO Link is connected successfully!

### **How to set the location to save?**

1. Click the setting icon in the top right corner of Wifi transfer page ;
2. Select the 'save location' you prefer ;
3. Click 'confirm'

# Firmware upgrade, factory data reset and technical support

## 1. How to upgrade firmware?

The M17 supports online upgrade and local upgrade.

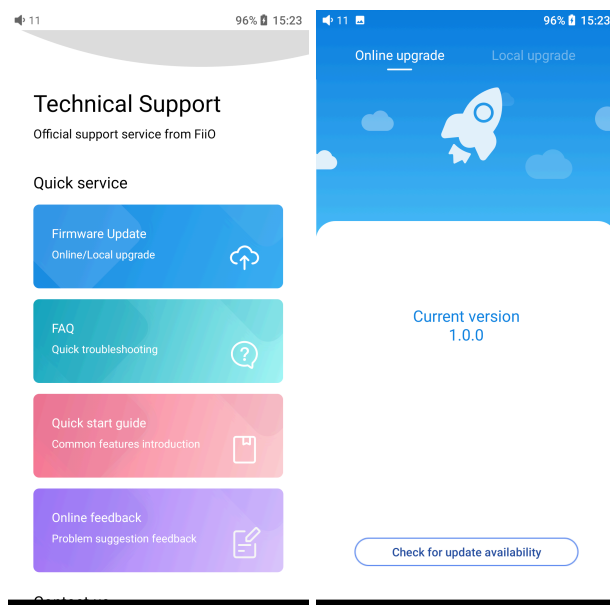

### Online upgrade

If a new firmware is available and can be detected (with the M17 connected to an available internet), an upgrade notification will show up in the notification center. Tap on it to enter the update menu for the online upgrade. If there's no upgrade notification showing up, you can go to the "Technical Support->Firmware Upgrade" menu, and tap the "Check for updates" icon to check manually.

### Local upgrade

Also, the M17 can be upgraded locally by a firmware package. Download the firmware package file from FiiO website, and copy it to the internal storage of the M17 or an SD card. Go to the "Technical Support->Firmware Upgrade->Local Upgrade" menu, and find the firmware package file to start the upgrade.

Notes:

1. Do not unzip the firmware package file.
2. Before the upgrade, ensure the power of the device is adequate (>30%) so to avoid upgrade failure.
3. If the device goes to factory mode which cannot detect the firmware, the reason may be that the firmware file is damaged. At this time, press the power button to reboot the device. Re-download the firmware file and restart the upgrade.

## 2. Force to reboot

If something wrong happened to the device (stuck in the Welcome page, no response, etc.), you can hold the Power and the Play button together for 10 seconds to force it to reboot.

## 3. Factory data reset

If there are some problems that happened to the device, performing the factory data reset would help (In the menu of Settings->System->Reset options).

Notes: The "Factory data reset" will erase all data from the internal storage and reset the device to defaults. Please backup corresponding files in advance.



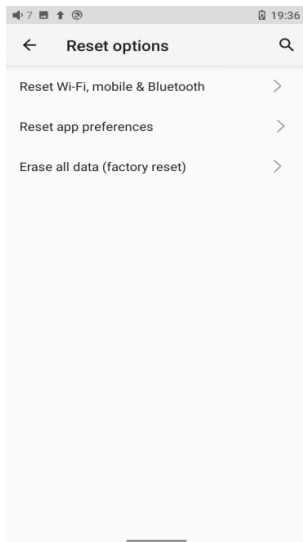

## 4. Technical support

- 1) On the homepage, tap Technical Support to enter the menu. Here are several commonly-used functions and our contacts.
- 2) Firmware update: online and local upgrade are available.
- FAQ (frequently asked questions): parts of frequently asked questions and corresponding measures are listed.
- 3) Quick start guide: tap to check out the internal quick start guide of the M17.
- 4) Contact us: here shows our email address, Facebook, Twitter, etc.

