



MOMENTUM True Wireless 4

True Wireless stereo earbuds

Model: MTW4, MTW4 R, MTW4 L, MTW4 C



Instruction manual

Use the search function, the navigation (left) or the following links:

Start

“Product overview”

“Getting started”

“Using the earbuds”

“FAQ/If a problem occurs ...”

“Specifications”

Sonova Consumer Hearing GmbH

Am Labor 1
30900 Wedemark
Germany



www.sennheiser-hearing.com

Version: 04/24 A02

Important safety instructions

- ▷ Read this instruction manual carefully and completely before using the product.
- ▷ Always include this instruction manual when passing the product on to third parties.
- ▷ Do not use the product if it is obviously defective or makes loud, unusual (whistling or beeping) noise.
- ▷ Only use the product in environments where **Bluetooth®** wireless transmission is permitted.

Preventing damage to health and accidents

- ▷ Protect your hearing from high volume levels. Permanent hearing damage may occur when earbuds are used at high volume levels for long periods of time. Sennheiser earbuds sound exceptionally good at low and medium volume levels. 
- ▷ Do not insert the earbuds too deep into your ears and never insert them without ear adapters. Always remove the earbuds slowly and carefully from your ears.
- ▷ The product generates stronger permanent magnetic fields that could cause interference with cardiac pacemakers, implanted defibrillators (ICDs) and other implants. Always maintain a distance of at least 3.94"/10 cm between the product component containing the magnet (earbuds and charging case) and the cardiac pacemaker, implanted defibrillator, or other implant.  
- ▷ Keep the product, accessories and packaging parts out of reach of children and pets to prevent accidents. Swallowing and choking hazard.
- ▷ Do not use the product in an environment that requires your special attention (e.g. in traffic). Especially the product's active noise cancellation can make ambient sounds inaudible or drastically change the perception of acoustic warning signals.

Preventing damage to the product and malfunctions

- ▷ Always keep the product dry and do not expose it to extreme temperatures (hairdryer, heater, extended exposure to sunlight, etc.) to avoid corrosion or deformation. The normal operating temperature is from 0 °C to 40 °C/32 °F to 104 °F.
- ▷ To avoid loud, unusual (whistling or beeping) noise and to ensure proper noise cancellation, do not cover the microphone openings of the active noise cancellation circuitry located on the outside of the product.
- ▷ Use only attachments/accessories/spare parts supplied or recommended by Sonova Consumer Hearing.
- ▷ Clean the product only with a soft, dry cloth. Product parts with ingress protection (IP protection rating) can be cleaned with a slightly damp cloth.

Safety instructions for Lithium rechargeable batteries



WARNING

If abused or misused, rechargeable batteries may leak. In extreme cases, they may even present a risk of:

- explosion
- heat and fire development
- smoke and/or gas development
- damage to health and/or the environment

	Only use rechargeable batteries and chargers recommended by Sonova Consumer Hearing.
	Do not leave the product/rechargeable batteries unattended while charging.
	Only charge the product / rechargeable batteries at ambient temperatures between 5 °C and 35 °C/41 °F and 95 °F and do not charge them near easily flammable objects.
	Do not charge the product/rechargeable batteries in a damp or humid environment. Make sure that the charging socket is free from moisture and contamination.
	Do not heat the product / rechargeable batteries above 70 °C/140 °F. Avoid exposure to sunlight and do not throw the product / rechargeable batteries into fire.
	Switch rechargeable battery-powered products off after use.
	When not using the product/rechargeable batteries for extended periods of time, charge them regularly (about every 3 months).
	This product contains coin rechargeable batteries. If you think the product/a coin rechargeable battery has been swallowed or is lodged in the body, seek medical assistance immediately.
	Avoid prolonged skin contact with the product, rechargeable battery, charger or charging cable when connected to a power source. These components can heat up during charging and cause skin irritation.
	Dispose of defective products with built-in rechargeable batteries at special collection points or return them to your specialist dealer to facilitate recycling.

Notes on the ingress protection rating of the earbuds

The earbuds feature an IP54 ingress protection rating which means they are protected from the ingress of water (protection class according to International Protection Marking (IP code), IEC standard 60529, tested under laboratory conditions).

The earbuds can be used in the rain, for example. However, they are not suitable for immersion in water or for wearing in the shower. In case of permanent moisture/wetness, the ingress protection can be reduced and the product can be damaged.

Important safety instructions

- ▷ Do not charge wet earbuds. Completely dry wet earbuds with a dry cloth before charging them.

The charging case is not splash waterproof.

- ▷ Do not use if immersed into liquid.
- ▷ Always keep the charging case dry.
- ▷ Make sure that the charging socket is free from moisture and contamination.
- ▷ Only use high-quality USB charging cables with USB-IF certification.

If the charging case has become damp or wet:

- ▷ Dry the charging case completely with a dry cloth.
- ▷ Allow the charging case to dry at room temperature for at least 24 hours before using and charging it again.
- ▷ Do not continue to use the product if it is obviously defective.

Notes on data collection and processing and on firmware updates

This product stores individual settings such as the volume and the Bluetooth addresses of paired devices. This data is required for the operation of the product and is not transferred to Sonova Consumer Hearing GmbH or companies commissioned by Sonova Consumer Hearing GmbH and is not processed.

Using the “Sennheiser Smart Control” app, you can update the firmware of the product for free via an Internet connection. If the device on which the app is installed is connected to the Internet, the following data is automatically transferred to and processed by Sonova Consumer Hearing servers in order to provide and transfer suitable firmware updates: hardware identifier, hardware revision number, firmware version of the product, operating system type (Android, iOS) and version, version of the app. The data is only used for the purpose of providing and transferring the firmware updates and is not stored permanently.

If you do not want this data to be transferred and processed, do not connect to the Internet.

Intended use/Liability

These headphones have been designed as an accessory for Bluetooth compliant devices. They are intended for wireless audio communication such as music playback and phone calls via Bluetooth wireless technology.

It is considered improper use when the product is used for any application not named in the corresponding product documentation.

Sonova Consumer Hearing GmbH does not accept liability for damage arising from misuse or improper use of this product and its attachments/accessories. Sonova Consumer Hearing GmbH is not liable for damages to USB devices that are not consistent with the USB specifications.

Sonova Consumer Hearing GmbH is not liable for damages resulting from the loss of connection due to flat or overaged rechargeable batteries or exceeding the Bluetooth transmission range.

Before putting into operation, please observe the respective country-specific regulations.

Package contents

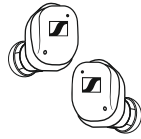

Earbud R for right ear (model: MTW4 R) and earbud L for left ear (model: MTW4 L)



Charging case (model: MTW4 C) with built-in rechargeable battery for the earbuds and wireless charging function

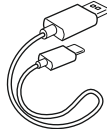

USB charging cable with USB-C and USB-A connector, approx. 0,4 m

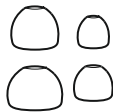

Silicone ear adapters (size XS, S, M (pre-mounted to the earbuds) and L)

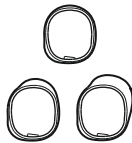

Silicone ear fins (size S, M (pre-mounted to the earbuds) and L)



Quick guide



Safety guide

Online you can find:

- this detailed instruction manual and additional information (www.sennheiser-hearing.com/download)
- the Sennheiser Smart Control app for configuring the earbuds and for additional functions
 - Google Play Store: [click](#)
 - Apple App Store: [click](#)
- a list of accessories on the MOMENTUM True Wireless 4 product page at www.sennheiser-hearing.com/momentum-true-wireless-4 (to purchase online or contact your local Sonova Consumer Hearing partner: www.sennheiser-hearing.com/service-support)

Product overview

Charging case

Model: MTW4 C

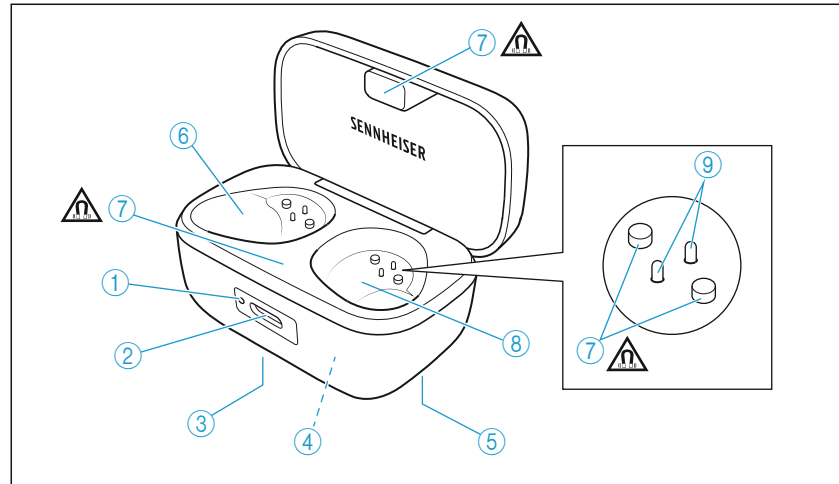

- ① LED display indicates the charging process/charge status of the rechargeable battery of the charging case or of the earbuds (when inserted into the charging case)
- ② Input for USB-C connector for charging the rechargeable batteries
- ③ Contact area for wireless charging of the rechargeable batteries
- ④ Built-in rechargeable battery for charging the earbuds on the go
- ⑤ Type plate
- ⑥ Charging compartment for the left earbud **L**
- ⑦ Magnetic holders
- ⑧ Charging compartment for the right earbud **R**
- ⑨ Charging contacts

Earbuds

Model: MTW4 R and MTW4 L

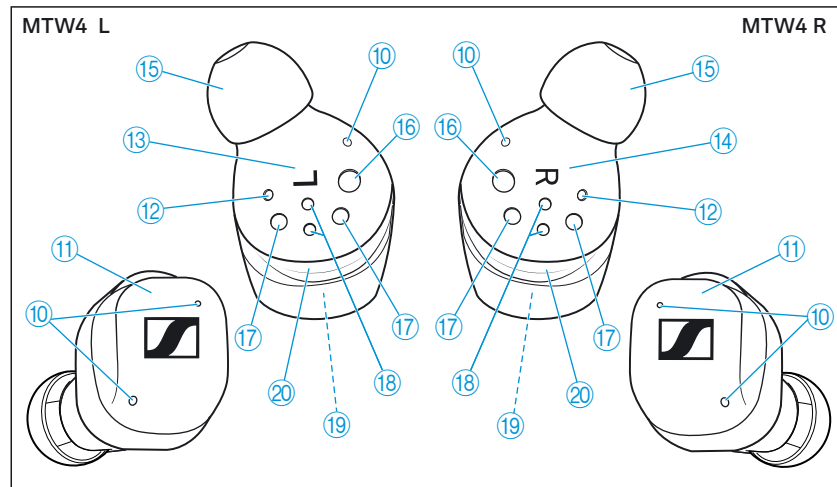

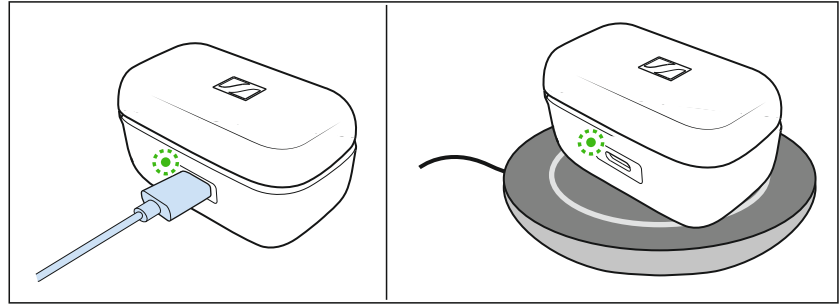

- ⑩ Microphones for the active noise cancellation ANC, for the perception of your surroundings (“Transparency Mode”) and for phone calls
- ⑪ Touch control panel
- ⑫ Status LED
- ⑬ Left earbud **L**
- ⑭ Right earbud **R**
- ⑮ Changeable silicone ear adapters
- ⑯ Infra-red proximity sensor
- ⑰ Magnetic holders
- ⑱ Charging contacts
- ⑲ Built-in rechargeable battery
- ⑳ Changeable ear fins for a secure fit of the earbuds in the ears

Overview of the LED display of the charging case





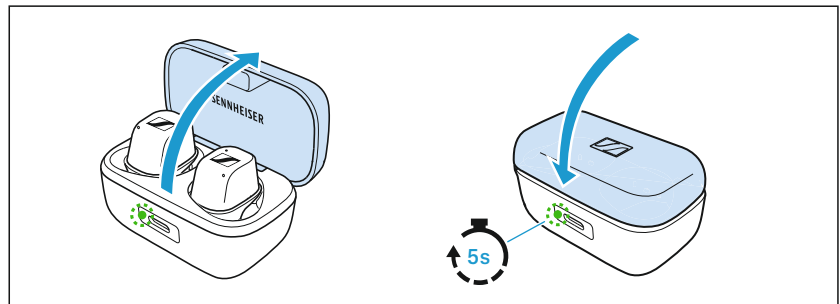

When a USB cable is connected or the charging case is placed on a wireless charging station, the LED of the charging case permanently displays the charging process:

LED		Charging case WITH earbuds inserted	Charging case WITHOUT earbuds inserted
	pulses yellow	Earbuds and charging case are being charged.	Charging case is being charged.
	lights up green	Earbuds and charging case are fully charged.	Charging case is fully charged.
	flashes red	At least one earbud has a charging error/battery error (> 44).	Charging case has a charging error/battery error (> 44).



If you open the lid of the charging case and no USB cable is connected or the charging case is not placed on a wireless charging station, the LED of the charging case displays the battery charge status or the charging process of the earbuds. If you close the lid of the charging case, the LED display goes off after 5 seconds.

LED		Charging case WITH earbuds inserted	Charging case WITHOUT earbuds inserted
	lights up green	Earbuds are fully charged, charging case is more than 50 % charged.	Charging case is more than 50 % charged.
	pulses yellow	Earbuds are being charged via the rechargeable battery of the charging case.	–
	lights up yellow	Earbuds are fully charged, charging case is less than 50 % charged.	Charging case is charged less than 50 %.
	lights up red	Rechargeable batteries of the earbuds and the charging case are almost empty.	Rechargeable battery of the charging case is almost empty.
	flashes red	At least one earbud has a charging error/battery error (> 44).	Charging case has a charging error/battery error (> 44).









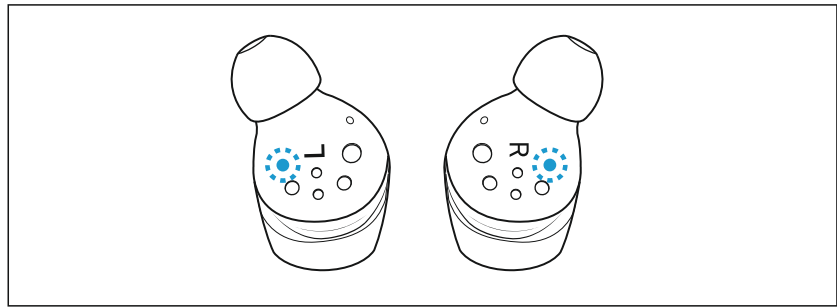

If the LED display does not light up:

- Clean the contacts on the earbuds and in the charging case (> 41).
- Make sure that the charging case rests on the wireless charging station (maximum distance 3 mm).
- Wait for at least 10 seconds. With some wireless charging stations the charging process starts delayed.
- Observe the installation instructions of the wireless charging station and make sure that no electromagnetic fields or materials influence the charging station (see instruction manual of the wireless charging station).
- Charge the rechargeable batteries of the charging case and the earbuds until the LED display lights up again (at least 30 minutes) (> 17).

Overview of the LED indications of the earbuds



LED		Meaning
	flashes red-blue for approx. 2 minutes	Earbuds are in Bluetooth pairing mode.
 3x	flashes blue 3x	Bluetooth pairing or earbud pairing was successful.
 3x	flashes red 3x	Bluetooth pairing or earbud pairing failed.
	lights up blue	Earbuds are connected to a device via Bluetooth.
	lights up red	Earbuds are not connected to a device via Bluetooth or the connection has been interrupted.
	flashes red quickly	Rechargeable battery is almost empty.
	flashes red slowly	System error is present. Perform a reset (> 47).
	flashes red-green for approx. 1 minute	Earbuds are in earbud pairing mode (to pair the right and left earbud).

i When you insert the earbuds into your ears, the LEDs of the earbuds automatically go off.

When you do not insert the earbuds into your ears, the LEDs of the earbuds go off after 30 seconds.

Notes on voice prompts

The earbuds output voice prompts for events (the table gives some examples). Using the Smart Control app, you can change the language of the voice prompts, choose between voice prompts and beep sounds, or deactivate the status messages with a few exceptions (e.g. rechargeable battery is empty).

Voice prompt	Meaning
“Power on”	Earbuds are switched on.
“Power off”	Earbuds switch off.
“Connected”	Earbuds are connected via Bluetooth.
“No connection”	Earbuds are not connected via Bluetooth.
“Pairing”	Earbuds are in Bluetooth pairing mode.
“Pairing cancelled”	Bluetooth pairing mode was cancelled.
“Pairing successful”	Bluetooth pairing was successful.
“Pairing failed”	Bluetooth pairing was not successful.
“Recharge headset”	Rechargeable battery is almost empty. Recharge the rechargeable battery.
“Call rejected”	Incoming call rejected.
“Call ended”	Call ended.
“Mute on”	Muting of the microphones during an active call.
“Mute off”	Muting of the microphones is canceled.
“Volume min”	Volume set to minimum.
“Volume max”	Volume set to maximum.

Getting started

1. Waking up the earbuds and the charging case and charging the rechargeable batteries

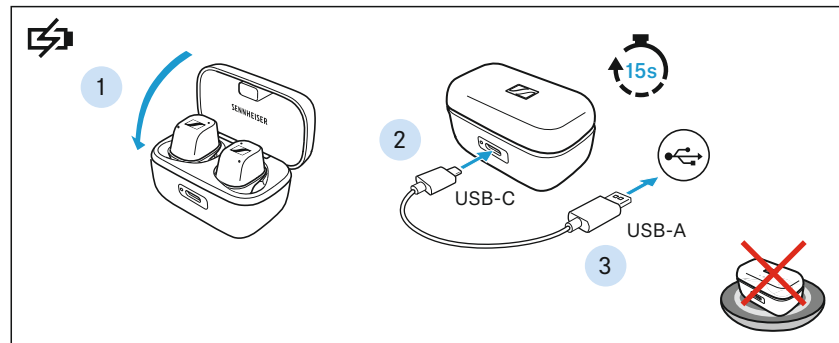

Upon delivery, the rechargeable batteries of the earbuds and the charging case are in sleep mode and have to be woken up by connecting them to a USB power source once.

1. Insert the earbuds into the charging case and close the lid of the charging case.
2. Connect the USB-C cable to the charging case.
3. Connect the cable to a USB power source (> 17) and charge the rechargeable batteries for at least 15 seconds. The earbuds and the charging case are woken up and the rechargeable batteries are being charged. The earbuds are now ready for use.

i Waking up the rechargeable batteries is only possible when a USB cable is connected to the charging case. The wireless charging function cannot be used to wake up the rechargeable batteries.

i We recommend charging the earbuds and the charging case for a complete charging cycle without interruption before using for the first time.

2. Selecting suitable ear adapters and ear fins for optimum fit of the earbuds in the ears

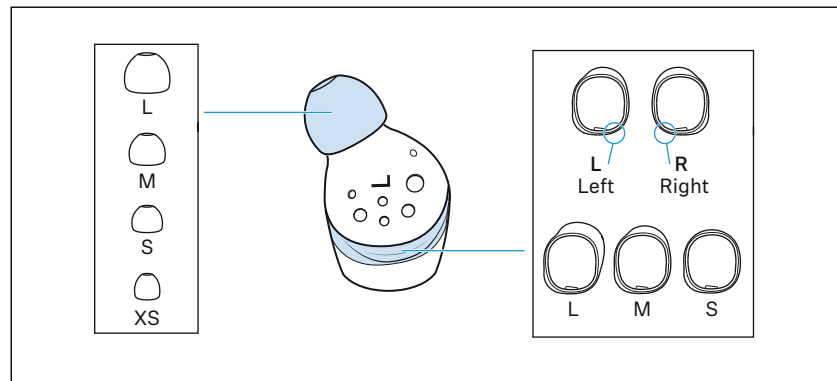

The perceived sound quality including bass performance, the best possible noise cancellation, the best voice quality for phone calls and the secure hold of the earbuds in the ears depend to a large extent on the correct fit of the earbuds. Therefore, you can choose between ear adapters and ear fins in different sizes.

You can choose between 4 different ear adapters in size XS, S, M and L and 3 different ear fins in size S, M and L (> 26).

- ▷ Test which ear adapter size and which ear fins give you the best sound quality and the best wearing comfort.

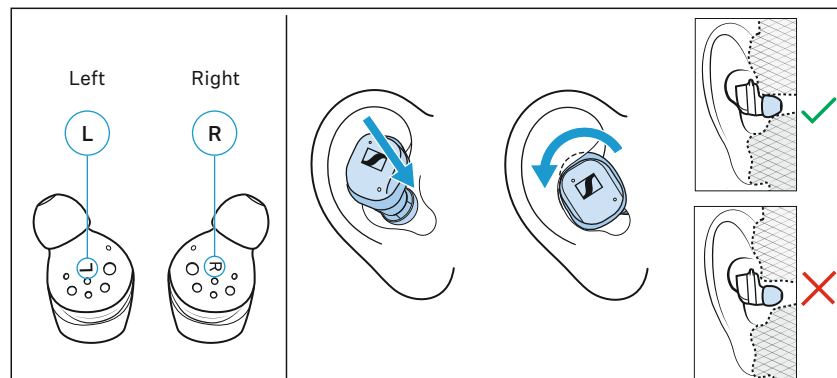

- ▷ Assign the right earbud to your right ear and the left earbud to your left ear.
- ▷ Insert the earbuds at a slight angle into the ears and twist them slightly into the ear canal so that they sit comfortably and snugly in the ear canal and auricle (> 27).

i You can use the Fit Test function in the Smart Control app to test the fit of the earbuds in your ears.

3. Connecting the earbuds to a Bluetooth device

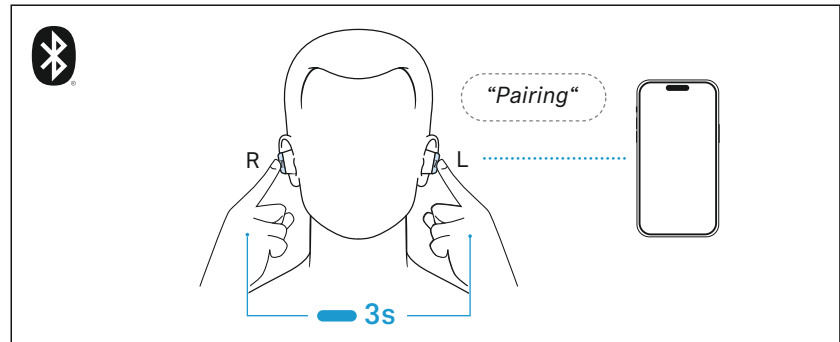

When you switch on the earbuds for the first time after initial charging, they automatically switch to Bluetooth pairing mode. If the earbuds have not yet been paired with any Bluetooth device (the pairing list is empty), pairing mode remains permanently activated.

▷ Connect the earbuds to your smartphone via Bluetooth (> 22).

4. Installing the Smart Control app on your smartphone

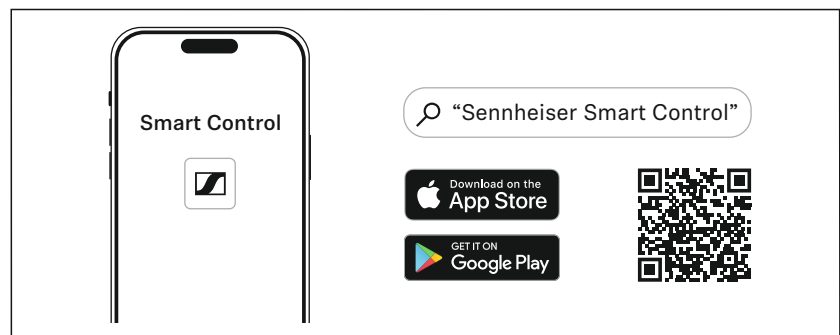

The Sennheiser **Smart Control** app allows you to use all functions and settings of the earbuds and to e.g. adjust the sound to your liking using the equalizer (> 23).

- Google Play Store: [click](#)
- Apple App Store: [click](#)

5. Connecting additional Bluetooth devices

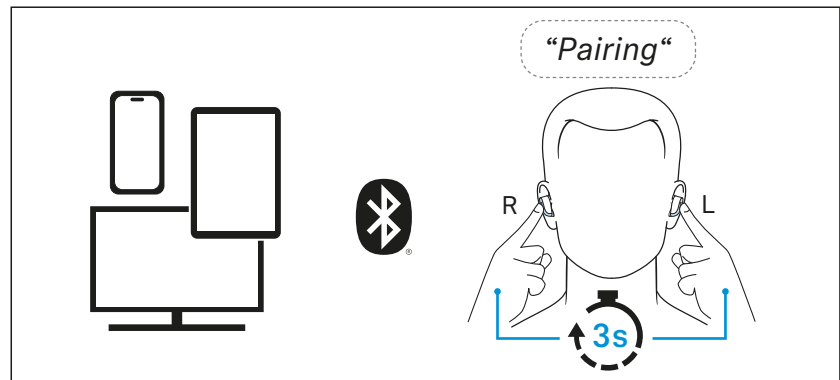

- ▷ If desired, connect the earbuds to additional devices via Bluetooth (> 22).

The earbuds can save the connection profiles of up to six Bluetooth devices with which they have been paired. Audio playback is only possible from one device at a time.

Using the Smart Control app ("Connections"), you can view the list of paired devices and selectively connect and disconnect devices (> 23).

Using the earbuds

Information on the rechargeable battery, the charging process and the first use

The earbuds and the charging case each have a built-in rechargeable battery.

To charge the rechargeable batteries, you can use one of the following options:

- the supplied USB cable
- a wireless charging station (Qi-compatible, to be ordered separately)

The earbuds must be inserted into the charging case for charging. Thus, even on the go, the earbuds are always safely stored and charged.

Upon delivery, the rechargeable batteries of the earbuds and the charging case are in sleep mode and have to be woken up by connecting them to a USB power source for at least 30 seconds. The lid of the charging case must be closed during this process.

A complete charging cycle of the charging case and the earbuds takes about 1.5 hours. The quick charge function gives you approx. 1 hour of playback time after 8 minutes of charging. The charging time can vary depending on the power source used and the ambient temperature.

We recommend charging the earbuds and the charging case for a complete charging cycle without interruption before using for the first time.

When a USB cable connected to a power source is also connected to the charging case or when you place the charging case on a wireless charging station, the rechargeable battery of the charging case is being charged. When the earbuds are inserted into the charging case, their rechargeable batteries are being charged at the same time. The LED display of the charging case indicates the charging process (> 8).

When the charge status of the earbuds' rechargeable batteries drops to a critical level, a voice prompt asks you to recharge the earbuds ("Recharge headset").

The charge status of the rechargeable battery of the charging case is indicated by the LED display on the charging case (> 8).

At the end of its operational lifetime, this product with its built-in rechargeable battery must be disposed of separately from normal household waste. You can find more information here: > 50.

 The earbuds feature an Eco mode that allows for longer battery life (> 38) and a battery protection mode that ensures gentle charging and thus longer battery life (> 38).

You can activate both modes via the Smart Control app.

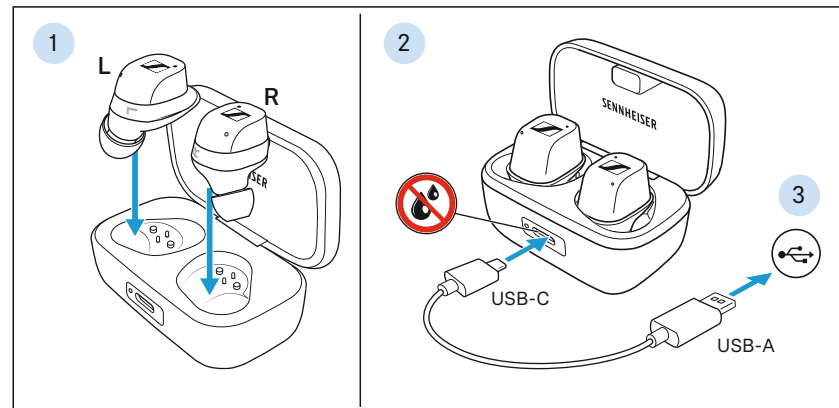

Charging the rechargeable batteries using the USB cable



1. Open the charging case by overcoming a slight magnetic resistance and insert the left earbud into the left charging compartment and the right earbud into the right charging compartment. The earbuds are magnetically pulled into the charging compartments.
2. Make sure that the charging socket is free from moisture and contamination. Connect the USB-C connector of the charging cable to the USB socket of the charging case.
3. Connect the USB-A connector to a corresponding socket of a USB power source (to be ordered separately). Make sure that the USB power source is connected to the power supply system. The rechargeable batteries of the earbuds and the charging case are being charged.

If no earbuds are inserted into the charging case, only the rechargeable battery of the charging case is being charged.

The LED display of the charging case indicates the charge status:

LED		Charging case WITH earbuds inserted	Charging case WITHOUT earbuds inserted
	pulses yellow	Earbuds and charging case are being charged.	Charging case is being charged.
	lights up green	Earbuds and charging case are fully charged.	Charging case is fully charged.
	flashes red	At least one earbud has a charging error/battery error (> 44).	Charging case has a charging error/battery error (> 44).

i If the LED display does not light up:

- Clean the contacts on the earbuds and in the charging case (> 41).
- Clean the USB-C socket of the charging case.
- Charge the rechargeable batteries of the charging case and the earbuds until the LED display lights up again (at least 30 minutes).

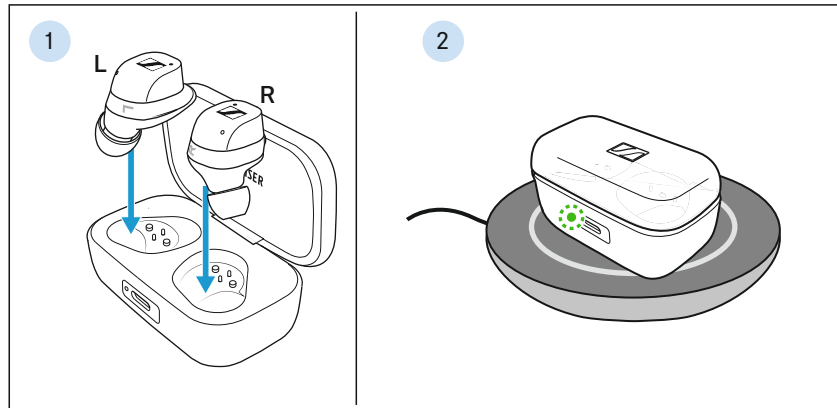

Charging the rechargeable batteries wirelessly



1. Open the charging case by overcoming a slight magnetic resistance and insert the left earbud into the left charging compartment and the right earbud into the right charging compartment. The earbuds are magnetically pulled into the charging compartments.
2. Place the bottom of the charging case centered on a wireless charging station (Qi-compatible, to be ordered separately). The rechargeable batteries of the earbuds and the charging case are being charged.

If no earbuds are inserted into the charging case, only the rechargeable battery of the charging case is being charged.

The LED display of the charging case indicates the charge status:

LED		Charging case WITH earbuds inserted	Charging case WITHOUT earbuds inserted
	pulses yellow	Earbuds and charging case are being charged.	Charging case is being charged.
	lights up green	Earbuds and charging case are fully charged.	Charging case is fully charged.
	flashes red	At least one earbud has a charging error/battery error (> 44).	Charging case has a charging error/battery error (> 44).

i If the LED display does not light up:

- Clean the contacts on the earbuds and in the charging case (> 41).
- Make sure that the charging case rests on the wireless charging station (maximum distance 3 mm).
- Wait for at least 10 seconds. With some wireless charging stations the charging process starts delayed.
- Observe the installation instructions of the wireless charging station and make sure that no electromagnetic fields or materials influence the charging station (see instruction manual of the wireless charging station).
- Charge the rechargeable batteries of the charging case and the earbuds until the LED display lights up again (at least 30 minutes) (> 17).

Connecting the earbuds to a Bluetooth device

To be able to use the Bluetooth wireless connection, you must register both devices (earbuds and Bluetooth device, e.g. smartphone) via the settings of your Bluetooth device. This process is called pairing. If operation differs from the steps mentioned, also refer to the instruction manual of the Bluetooth device you are using.

 When you switch on the earbuds for the first time after initial charging, they automatically switch to Bluetooth pairing mode.

Information on the Bluetooth wireless connection

The earbuds are Bluetooth 5.4, LE Audio and Auracast™ broadcast audio certified.

Bluetooth

If your audio source supports one of the following high-resolution audio encoding methods, music is automatically played in high audio quality: aptX™ Adaptive or AAC. Otherwise the earbuds will play back your music in normal audio quality (SBC). Depending on the Bluetooth device used, playback via LE Audio is also possible. The used audio coding is displayed via the Smart Control app.

Paired devices establish the Bluetooth wireless connection immediately after switch-on and are ready for use.

When switched on, the earbuds will automatically try to connect to the last two Bluetooth devices used. The earbuds can save the connection profiles of up to six Bluetooth devices with which they have been paired. Audio playback is only possible from one device at a time.

If you pair the earbuds with the seventh Bluetooth device, the connection profile of the least used Bluetooth device will be overwritten. If you want to connect to this Bluetooth device again later, you have to pair the earbuds again.

Using the Smart Control app (“Connections”), you can view the list of paired devices and selectively connect and disconnect devices (> 23).

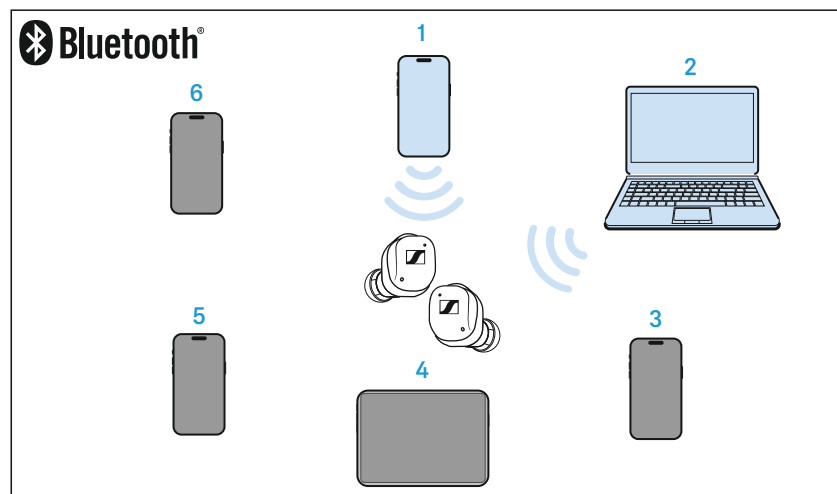

Paired and connected Bluetooth device



Paired Bluetooth device (currently not connected)

Auracast™ Broadcast Audio

Auracast™ technology allows an audio signal from a transmitter (e.g., tour guide systems in museums, televisions, or public address systems in conference centers) to be transmitted to an unlimited number of receiving devices (e.g., headphones, hearing aids) located within a fixed transmission radius. This allows audio data to be output to multiple output devices simultaneously, such as your own earbuds and a friend's earbuds.

Once a transmitter provides Auracast™ audio data, the receiving device can retrieve information about it. You can use the Smart Control app to select one of the public Auracast™ channels on your receiving device and play it. If your earbuds are connected to your device via Bluetooth, audio will be transmitted to the earbuds.

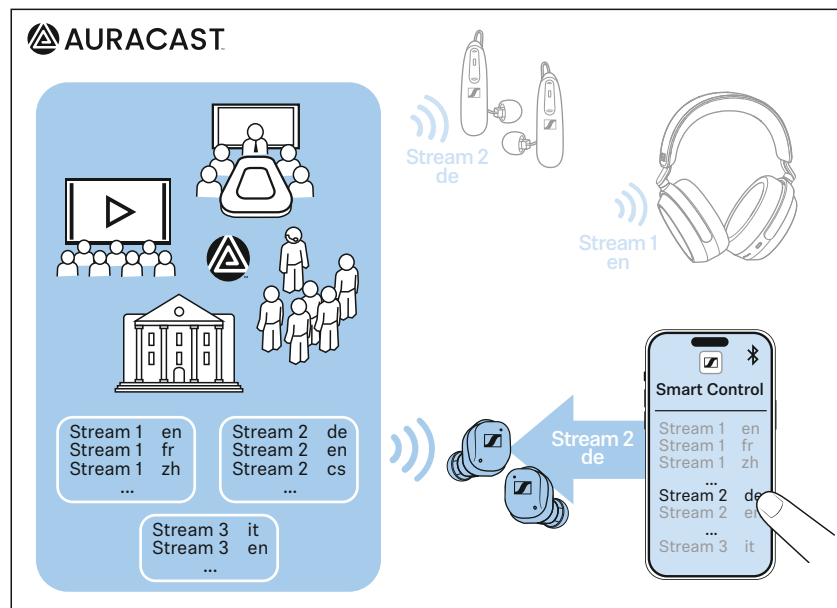

Pairing the earbuds with a Bluetooth device

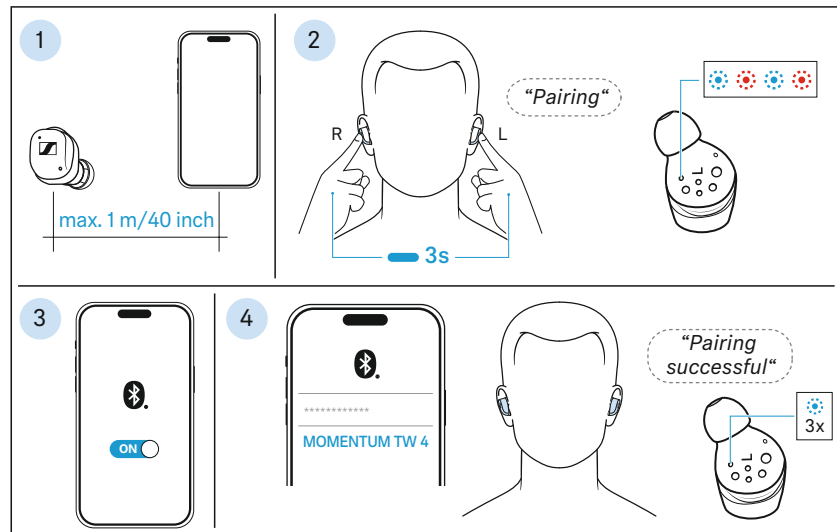

1. Take both earbuds out of the charging case and insert them into your ears (> 27). The distance between the earbuds and the Bluetooth device should not exceed 40"/1 m.
2. Simultaneously touch and hold the right and the left touch control panel for 3 seconds until you hear the voice prompt "Pairing" and a beep.
The LEDs of the earbuds flash blue and red. The earbuds are in pairing mode.
3. Activate Bluetooth on your Bluetooth device.
4. Via the menu of your Bluetooth device, start the search for new Bluetooth devices.
All active Bluetooth devices in the proximity of your device are displayed.
From the list of found Bluetooth devices, select "MOMENTUM TW 4". If necessary, enter the default pin code "0000".
If pairing was successful, you hear the voice prompt "Pairing successful" and the LEDs of the earbuds flash blue 3x.

i If no connection is established within 2 minutes, pairing mode is terminated and the earbuds switch to idle mode. If necessary, repeat the steps described above.

If the earbuds are not paired with any Bluetooth device (the pairing list is empty), pairing mode is permanently active.

Installing the Smart Control app

To be able to adjust the settings of the earbuds to your individual needs and to fully use all functions of the earbuds, you require the free Sennheiser **Smart Control** app on your smartphone.

i The earbuds can only be paired with Bluetooth devices when connected to the Smart Control app.

- ▷ Download the app from the Apple App Store or Google Play and install it on your smartphone.
 - Google Play Store: [click](#)
 - Apple App Store: [click](#)

Alternatively, you can use your smartphone to scan the following QR code or to call up the following Internet site:

www.sennheiser-hearing.com/smartcontrol

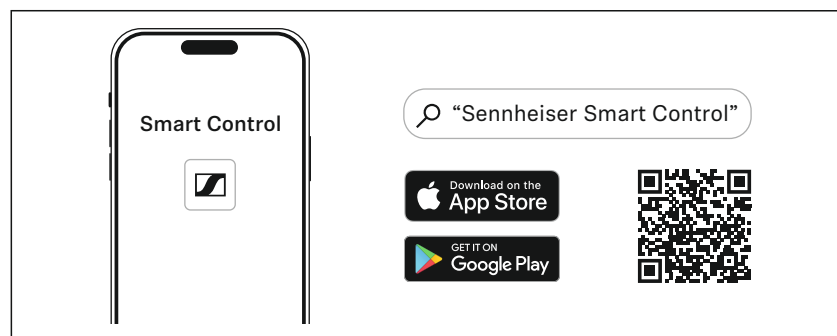

- ▷ Connect your smartphone to the earbuds via Bluetooth (> 22).
- ▷ Start the Smart Control app.
- ▷ Follow the instructions in the app.

Switching the connection to paired Bluetooth devices/“Connections”

To selectively switch the audio connection to paired Bluetooth devices using the “Connections” function, you require the Smart Control app (> 23).

- ▷ In the Smart Control app, tap “Connections”.
The list of Bluetooth devices paired with the earbuds appears.
- ▷ From the list, select the paired device to which you want to connect the earbuds. Make sure that the desired device is switched on and Bluetooth is activated.
The Bluetooth audio connection between the desired Bluetooth device and the earbuds is established.
The app connection between the device with the Smart Control app installed and the earbuds remains active (only Bluetooth Low Energy for communication between app and earbuds, the device name is highlighted in bold).

i Using the “Connections” function, you can also selectively delete pairing information of devices without resetting the earbuds to the factory default settings.

Disconnecting the earbuds from a Bluetooth device

- ▷ Via the menu of your Bluetooth device, disconnect the connection to the earbuds.

The earbuds are disconnected from the Bluetooth device.

The earbuds search for other paired devices. If no device is found, you hear the voice prompt “No connection”. The earbuds switch to idle mode.

i Using the “Connections” function in the Smart Control app, you can also selectively connect the earbuds to paired devices without terminating an existing connection or deleting the pairing information of certain devices (> 23).

i If you want to clear the Bluetooth pairing list of the earbuds, use the Smart Control app or reset the earbuds to the factory default settings (> 47).

Establishing a connection to Auracast™ transmitters

The “Auracast” function in the Sennheiser Smart Control app allows you to select and change the connection to an Auracast™ transmitter.

You can connect to several Auracast™ transmitters at the same time. The transmitter that is currently transmitting audio data is automatically played through your earbud.

- ▷ Make sure you are within the range of an Auracast™ transmitter.
- ▷ Make sure that your earbuds are connected to the Smart Control app (> 23).
- ▷ On the start screen of the Smart Control app, tap the “Auracast” section.

The transmitter search menu opens.

You can start an automatic transmitter search or select a transmitter directly via a QR code.

To start the automatic transmitter search:

- ▷ Tap the “Start search” button.
The Auracast™ transmitters available within the range are listed. As long as the “Search” animation is displayed in the menu, the transmitter search is active.

i Some connections to Auracast™ transmitters are subject to password protection. The corresponding transmitters are marked with a lock symbol (🔒) in the transmitter overview.

- ▷ In the list, tap the transmitter you want to connect to.
The Bluetooth audio connection to the selected transmitter is established. The selected transmitter is marked with a blue tick (✓).

As soon as the transmitter starts an audio transmission, it is played through your earbuds. The active audio transmission of a transmitter is indicated by the digital signal symbol (📶).

i You can repeat the automatic transmitter search by tapping the “Search programs” button below the transmitter list.





To select an Auracast™ transmitter via a QR code:

- ▷ Tap the QR code symbol (📱) in the transmitter search menu. The camera app or a QR scanner app opens on your Bluetooth device (depending on the model).
- ▷ Scan the QR code of the Auracast™ transmitter and follow the on-screen instructions to complete the process. The Bluetooth audio connection to the selected transmitter is established. The transmitter appears in the list of available transmitters and is marked with a blue tick (✓). As soon as the transmitter starts an audio transmission, it is played through your earbuds. The active audio transmission of a transmitter is indicated by the digital signal symbol (📶).

i When you leave the range of the Auracast™ transmitter, the connection and audio transmission are interrupted. However, the transmitter remains subscribed, i.e. as soon as you return to the range of the transmitter, the connection is re-established and the audio transmission starts automatically.

i During media playback, e.g. when listening to music, the Auracast™ transmission is played with priority. The current playback is muted.

Overview of the symbols when selecting an Auracast™ transmitter

Symbol		Meaning/function
	Blue tick	Auracast™ transmitter connected
	Blue digital signal	Auracast™ transmitter with active audio transmission
	Lock	Auracast™ transmitter with password protection
	QR code	Auracast™ transmitter search via QR code
	Information	Subscribing to or unsubscribing from an Auracast™ transmitter

Changing a connection to Auracast™ transmitters

If there is a connection to several Auracast™ transmitters that are transmitting audio data at the same time, the transmitter that was last active will be played through your earbuds.

You can change the transmitter manually.

- ▷ On the start screen of the Smart Control app, tap the “Auracast” section. The transmitter overview opens.
- ▷ Make sure that a Bluetooth audio connection to the desired transmitter is established and that the transmitter is transmitting audio data. You can tell by the blue tick (✓) and the digital signal symbol (📶).
- ▷ In the list, tap the transmitter you want to play. The transmitter’s audio data is played through your earbuds.

Disconnecting from an Auracast™ transmitter

- ▷ On the start screen of the Smart Control app, tap the “Auracast” section.
The transmitter overview opens.
Connected transmitters are marked with a blue tick (✓).
- ▷ Tap on the information symbol (i) of the transmitter whose connection you want to disconnect and unsubscribe.
The connection to the Auracast™ transmitter is disconnected and is no longer automatically re-established.

Selecting suitable ear adapters and ear fins for optimum fit of the earbuds

The perceived sound quality including bass performance, the best possible noise cancellation, the best voice quality for phone calls and the secure hold of the earbuds in the ears depend to a large extent on the correct fit of the earbuds. Therefore, you can choose between ear adapters and ear fins in different sizes.

Silicone ear adapters

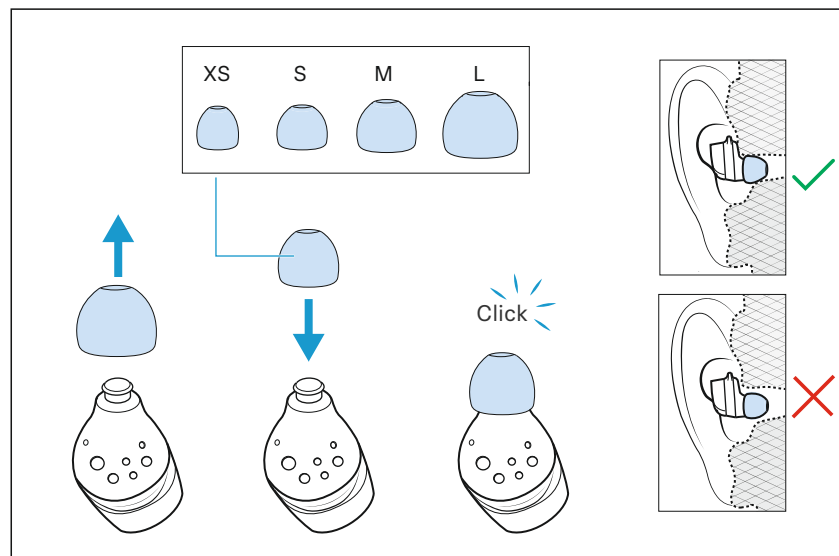

- ▷ Pull the ear adapter away from the in-ear sound tunnel.
- ▷ Mount the new ear adapter to the in-ear sound tunnel. Ensure that it locks into place.
- ▷ Test which ear adapter size gives you the best sound quality and the best wearing comfort.
You can choose between 4 different ear adapters in size XS, S, M and L. The ear adapters must fit snugly in the ear canal and completely seal your ears.

i You can use the Fit Test function in the Smart Control app to test the fit of the earbuds in your ears.

Silicone ear fins

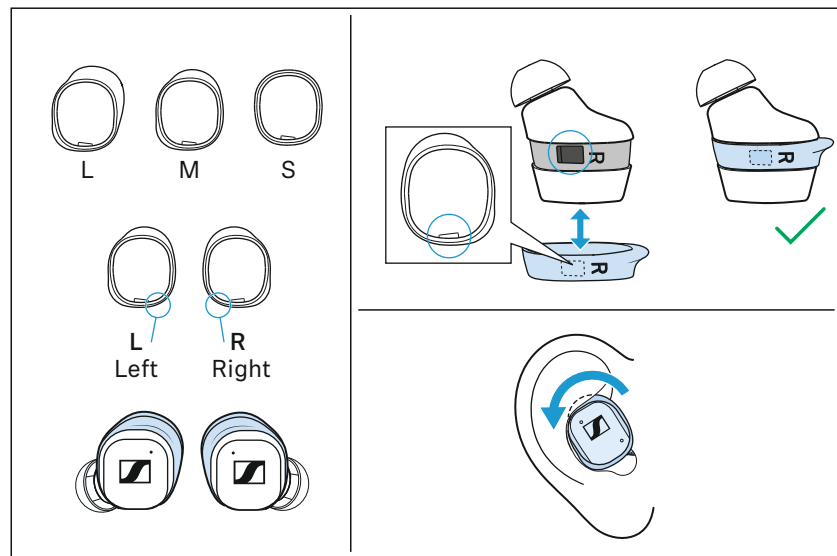

- ▷ Carefully remove the ear fin from the earbud housing.
- ▷ Assign the right and left ear fin to the right and left earbud (see embossing on the bottom).
- ▷ Place the latch on the inside of the ear fin ring into the recess provided on the earbud and slip the ring over the earbud housing. Make sure the ring fits neatly into the duct on the earbud housing.
- ▷ Test which ear fin size gives you the best fit and the best wearing comfort.
You can choose between 3 different ear fins in size S, M and L. The ear fin holds the earbud securely in the back of the ear. If you do not want to use an ear fin, put size S on the earbud.

Inserting the earbuds into the ears

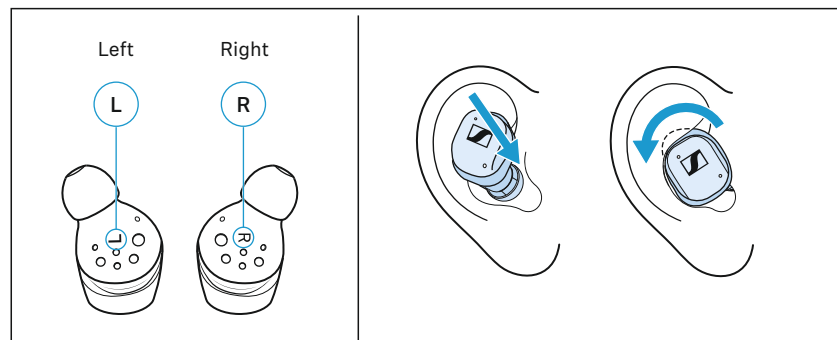

- ▷ Assign the right earbud to your right ear and the left earbud to your left ear.
- ▷ Insert the earbuds at a slight angle into the ears and twist them slightly into the ear canal so that they sit comfortably and snugly in the ear canal. If you are using an ear fin, make sure that the fin finds support in the auricle (> 26).

i The right or left earbud can be used alone. If you insert one earbud into the charging case during use, a short interruption of playback may occur in the other earbud.

i The Smart Pause function automatically stops music playback when you remove an earbud from the ear (> 33).

Switching the earbuds on



WARNING

Danger due to high volume levels!

Listening at high volume levels can lead to permanent hearing defects.

- ▷ Before inserting the earbuds into your ears, adjust the volume to a low level (> 29).
- ▷ Do not continuously expose yourself to high volume levels.

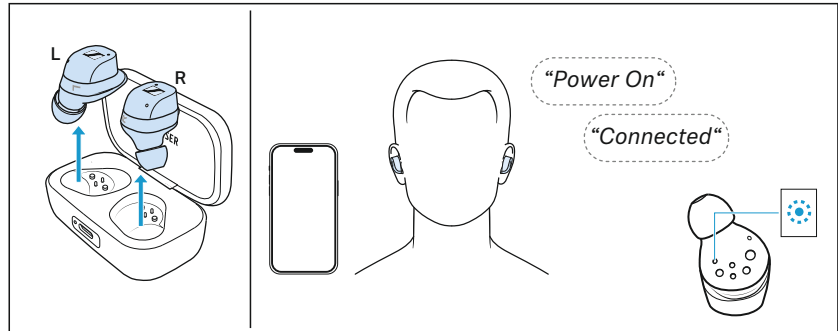

- ▷ Open the lid of the charging case and take out both earbuds.
- ▷ Insert the earbuds into your ears (> 27).
If a paired Bluetooth device is within the transmission range, you hear the voice prompts “Power On” and “Connected”. The LEDs of the earbuds light up blue.



If you take the earbuds out of the charging case during an incoming call, the call is automatically accepted and you can use the earbuds directly for making calls.

This Auto Call function can be deactivated via the Smart Control app (> 36).



The earbuds automatically switch to idle mode if no paired Bluetooth device can be found within 15 minutes. You can also change this setting via the Smart Control app.

You can wake up the earbuds from idle mode by touching their touch control panels 1x or by briefly inserting them into the charging case.

Switching the earbuds off

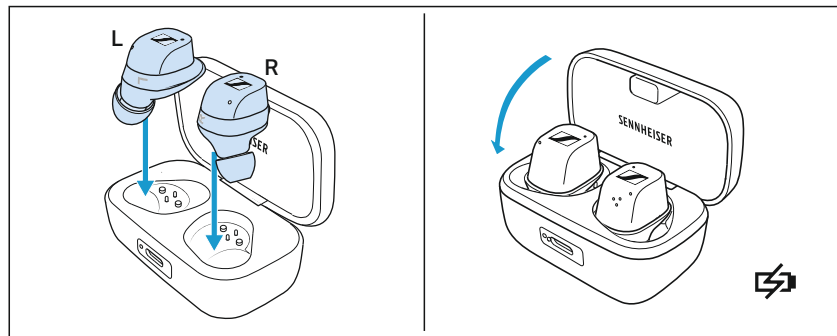

The earbuds do not have to be switched off explicitly.

- ▷ Insert the earbuds into the charging case and close the lid to switch them off.
As soon as the earbuds are inserted into the charging case and the lid of the charging case is closed, the earbuds switch off and are being charged (> 17).

i If you do not close the lid of the charging case, the Bluetooth connection is briefly interrupted but immediately restored and the earbuds are being charged.

i The earbuds automatically switch to idle mode if no paired Bluetooth device can be found within 15 minutes.
You can wake up the earbuds from idle mode by touching their touch control panels 1x or by briefly inserting them into the charging case.

Adjusting the volume



WARNING

Danger due to high volume levels!

Listening at high volume levels can lead to permanent hearing defects.

- ▷ Adjust the volume to a low level before inserting the earbuds or changing the audio source.
- ▷ Do not continuously expose yourself to high volume levels.

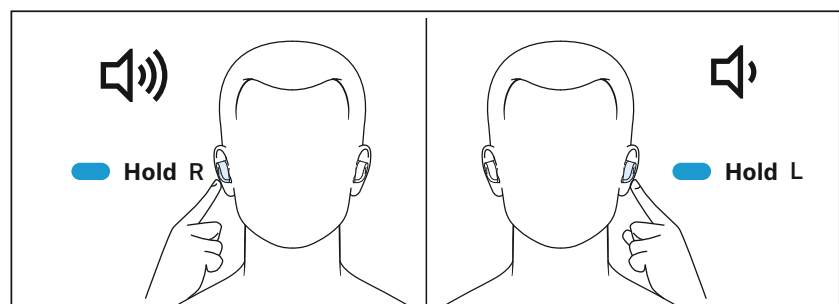

To increase the volume:

- ▷ Touch and hold the touch control panel of the right earbud until the volume is increased.

To reduce the volume:

- ▷ Touch and hold the touch control panel of the left earbud until the volume decreases.

When the maximum or minimum volume is reached, you hear the voice prompt “Volume max” or “Volume min”.

 You can also adjust the volume using the connected Bluetooth device.

 If you have activated the voice assistant (> 33) and then change the volume of the earbuds, the volume of the voice assistant is adjusted accordingly and saved permanently.

Information on the active noise cancellation ANC

Due to the wearing style in the ear canal, the earbuds provide effective passive isolation from ambient noise.

In addition, the earbuds are equipped with the active noise cancellation function ANC (“Active Noise Cancellation”), which allows you to reduce ambient noise to a minimum. Even when ANC is activated, the sound quality of your earbuds is always at its best.

If you want to create a quiet space in a noisy environment, you can simply use the earbuds as noise protection by using ANC.

With the Smart Control app, you can select different ANC modes that provide the optimal settings for your application situation. With adaptive noise cancellation, the intensity is automatically adjusted depending on the noise conditions.

Notes on active noise cancellation

- Continuous low-frequency noise, such as motor or fan noise, is particularly well suppressed.
- Speech or high-frequency noise is significantly reduced, but can remain perceptible.
- If unusual (whistling or beeping) noise occurs, remove the earbuds from your ears and reinsert them. Make sure that the earbuds properly fit in your ears and make a good seal with the ear canal.
- To avoid loud, unusual (whistling or beeping) noise and to ensure proper noise cancellation, do not cover the microphone openings of the active noise cancellation circuitry located on the outside of the earbuds.
- With active noise cancellation ANC activated, the battery life of the earbuds is reduced.

Activating/deactivating the active noise cancellation ANC

- ▷ Tap the touch control panel of the left earbud 3x.
The active noise cancellation ANC is activated or deactivated.

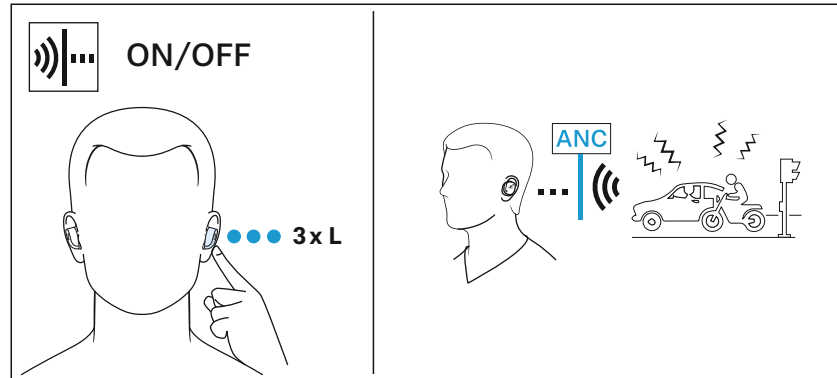

- i** You can also activate or deactivate the active noise cancellation ANC via the Smart Control app (> 23).
- i** During phone calls, the active noise cancellation ANC is always activated to ensure the best possible voice quality.

Adjusting the active noise cancellation ANC

To be able to adjust settings for the active noise cancellation ANC, you require the Smart Control app (> 23).

- ▷ In the Smart Control app, select the desired ANC mode:

ANC mode	Reduction of low-frequency noise and background noise
“Adaptive” *	Reduction depending on the noise conditions: <ul style="list-style-type: none"> – maximum reduction in a noisy environment – minimum reduction in a quiet environment
“Anti Wind”	Slight reduction to minimize disturbing wind or movement noise

*default setting

Listening to ambient sounds or conversations - activating/deactivating the Transparency Mode

With the Transparency Mode activated, you can hear ambient sounds or communicate without having to remove the earbuds from your ears. This allows you to hear e.g. announcements in the train or aircraft or to have short conversations.

With the Smart Control app, you can adjust the intensity of the Transparency Mode. This allows you to determine to which extent ambient noise reaches your ears.

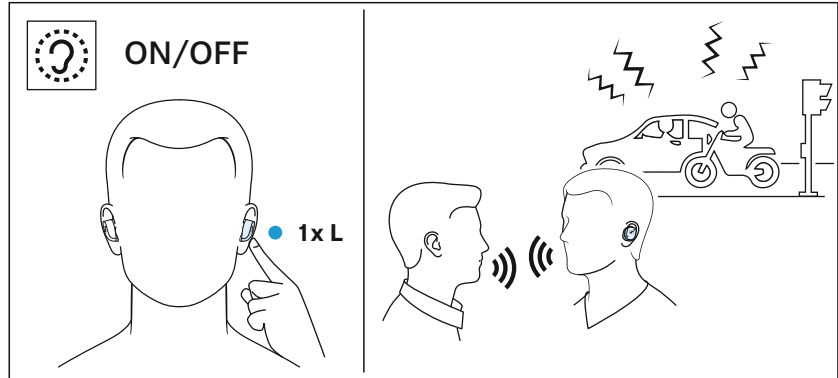

- ▷ Tap the touch control panel of the left earbud 1x.
The Transparency Mode set in the Smart Control app is activated.
You can hear ambient sounds without having to remove the earbuds from your ears.

To deactivate the Transparency Mode:

- ▷ Tap the touch control panel of the left earbud 1x.

Adjusting the playback pause in the Transparency Mode

You can select how audio playback behaves when the Transparency Mode is activated. To be able to adjust this setting, you require the Smart Control app (> 23).

- ▷ Select the desired setting in the “Transparency Mode” section of the Smart Control app:

“Automatic Pause”	Description
activated*	Audio playback (e.g. music) is muted and you hear only ambient sounds.
deactivated	Audio playback (e.g. music) continues and is mixed with ambient sounds.

*default setting



Using the voice assistant/voice dialing

- ▷ Tap the touch control panel of the right earbud 3x.
The available voice assistant of your Bluetooth device is activated (depending on the system used or app installed: Siri, Google Assistant or similar).
- ▷ Speak your request.

To cancel the selection or input to the voice assistant:

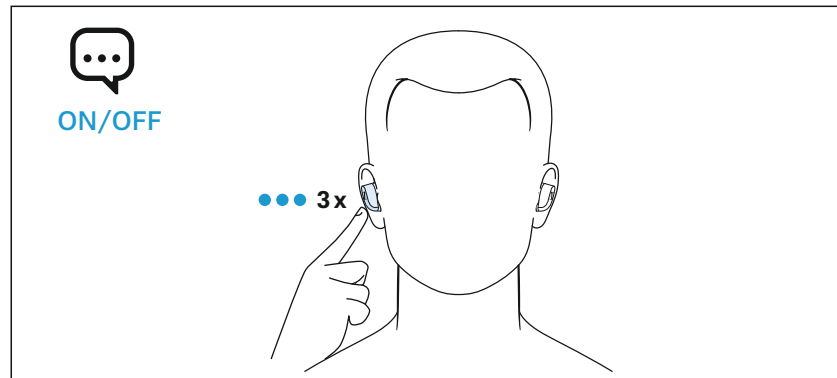
- ▷ Tap the touch control panel of the right earbud 1x.



Right touch control panel	Function
	Tap 3x 

i If you have activated the voice assistant and then change the volume of the earbuds (> 29), the volume of the voice assistant is adjusted accordingly and saved permanently.

Using the Smart Pause function

The earbuds automatically detect whether you are wearing the earbuds in your ear or removing them.

Music playback pauses when you remove an earbud from the ear and continues when you insert it again. If there is an interruption of more than 2 minutes, playback will not start automatically.

You can activate (default setting) or deactivate the function via the Smart Control app.



Controlling music playback

The music playback functions are only available when the earbuds and the Bluetooth device are connected. Some smartphones or music players may not support all functions.

Playing/pausing music

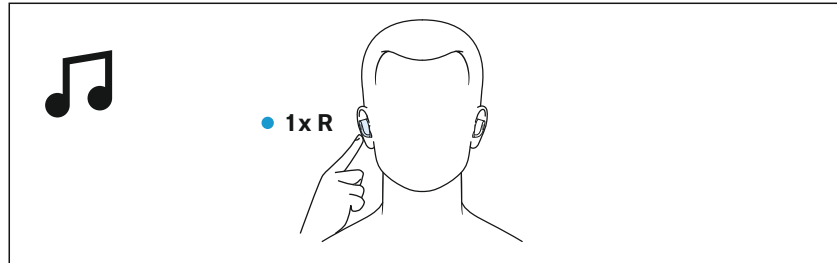
- ▷ Tap the touch control panel of the right earbud 1x.





Right touch control panel	Function
 Tap 1x 	Plays or pauses music

Playing the previous track

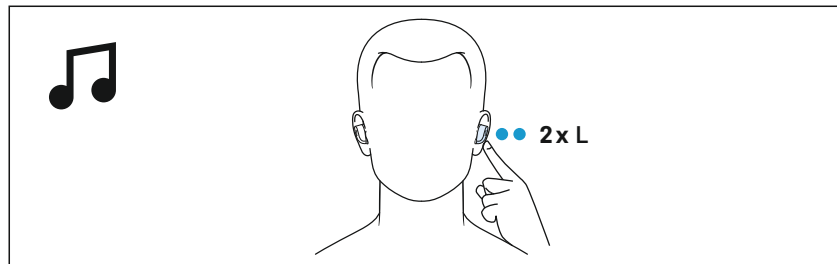
- ▷ Tap the touch control panel of the left earbud 2x.





Left touch control panel	Function
 Tap 2x 	Plays the previous track in the playlist

Playing the next track

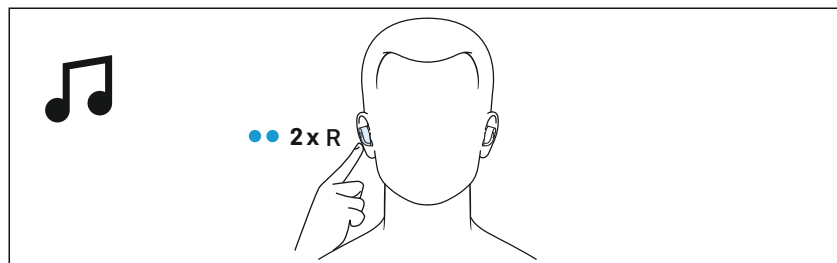
- ▷ Tap the touch control panel of the right earbud 2x.



Right touch control panel	Function
 Tap 2x 	Plays the next track in the playlist

Making calls using the earbuds

The call functions are only available when the earbuds and the Bluetooth device are connected. Some smartphones and telephony apps (e.g. WhatsApp, MS Teams, WeChat) may not support all call control functions.

During a call, you can use the [right and/or left earbud](#) to control the call functions.

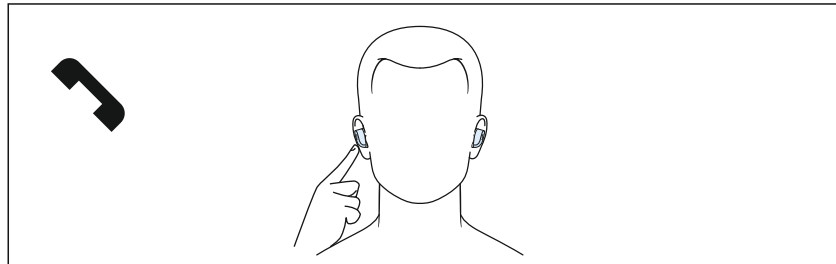

Making a call





- ▷ Dial the desired phone number.

If your Bluetooth device does not automatically transfer the call to the earbuds, select “MOMENTUM TW 4” as the output device on your device (see the instruction manual of your device if necessary).

Accepting/rejecting/ending a call

If your earbuds are connected to a Bluetooth device and you receive a call, you hear a ring tone in the earbuds.

If you are playing music when you receive a call, the music pauses until you end the call.

Right or left touch control panel		Function
	Tap 1x ●	Accepts a call
	Tap 2x ● ●	Ends a call Voice prompt “Call ended”
	Tap 2x ● ●	Rejects a call Voice prompt “Call rejected”
	Tap 1x ●	Accepts an incoming call and ends the active call
	Tap 2x ● ●	Rejects an incoming call and continues the active call

Muting the microphones

To mute the earbuds' microphones during a call:

- ▷ Tap the touch control panel of the right or left earbud 1x.
You hear the voice prompt "Mute on".
The microphones are muted.

To activate the microphones again:

- ▷ Tap the touch control panel of the right or left earbud 1x.
You hear the voice prompt "Mute off".
The microphones are activated again.

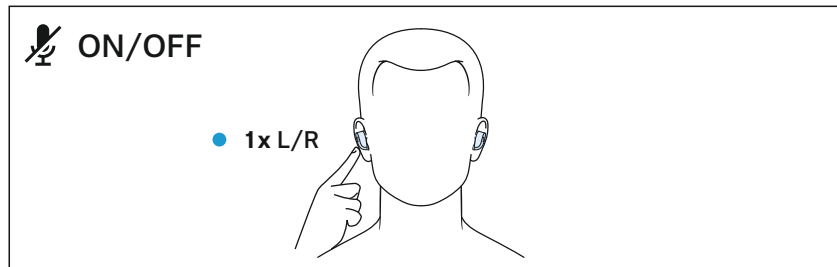

Using the Auto Call function

If you take the paired earbuds out of the charging case during an incoming call, the call is automatically accepted and you can use the earbuds directly for making calls.

You can activate (default setting) or deactivate the function via the Smart Control app. Note that both earbuds must be switched on to adjust the settings for both earbuds (right and left).

- i** The right or left earbud can be used alone. If you insert one earbud into the charging case during use, a short interruption of playback may occur in the other earbud.

Displaying the battery charge status

When the earbuds are connected to your Bluetooth device, the battery charge status can be displayed on the screen of your device (depending on the device and operating system used).

The Smart Control app also displays the charge status of the rechargeable batteries of the earbuds and the charging case.



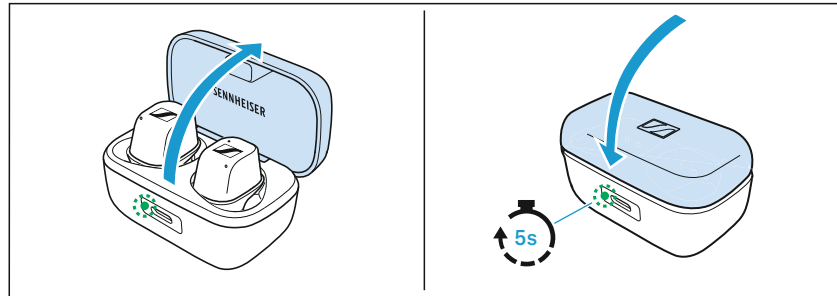

Displaying the battery charge status using the charging case



If no USB cable is connected to the charging case or the charging case is not placed on a wireless charging station:

- ▷ Open the lid of the charging case.
The LED display of the charging case indicates the battery charge status.

If you close the lid of the charging case, the LED display goes off after 5 seconds.

LED		Charging case WITH earbuds inserted	Charging case WITHOUT earbuds inserted
	lights up green	Earbuds are fully charged, charging case is more than 50 % charged.	Charging case is more than 50 % charged.
	pulses yellow	Earbuds are being charged via the rechargeable battery of the charging case.	–
	lights up yellow	Earbuds are fully charged, charging case is less than 50 % charged.	Charging case is charged less than 50 %.
	lights up red	Rechargeable batteries of the earbuds and the charging case are almost empty.	Rechargeable battery of the charging case is almost empty.
	flashes red	At least one earbud has a charging error/battery error (> 44).	Charging case has a charging error/battery error (> 44).

Adjusting sound effects/the equalizer

To be able to use the sound effects/the equalizer, you require the Smart Control app (> 23).

- ▷ In the Smart Control app, select the desired sound effects via the equalizer. You can use predefined presets, define sound modes (e.g. bass boost) or define your own settings.

The sound effects are stored in the earbuds. These sound settings are active even without using the Smart Control app, i.e. when you are using a different Bluetooth device.

Note that both earbuds must be switched on to adjust the settings for both earbuds (right and left).

i The Sound Check function of the Smart Control app allows you to create customized equalizer presets. Sound Check guides you step by step to the optimal result.

Battery protection mode

When the battery protection mode is activated, the rechargeable batteries of the earbuds are charged in a particularly protective way and only up to a charge level of approx. 80 % in order to extend the battery life. The maximum playback time of the earbuds is reduced accordingly to approx. 80 % of the standard playback time.

You can activate the battery protection mode via the Smart Control app (> 23).

Eco mode

Eco mode maximizes the playback time of your earbuds by optimizing energy consumption and can be activated via the Smart Control app (> 23). This mode can only be used with devices that support aptX™ transmission.

In Eco mode, the use of the aptX™ Bluetooth codec is deactivated and audio data is transmitted exclusively via SBC or ACC. This reduces the transmission bandwidth of the earbuds and increases the operating time of the battery.

To additionally maximize playback time, it is recommended to also deactivate the active noise cancellation ANC (> 31) and the Transparency Mode (> 32).

“High Resolution Audio” mode

A full bandwidth of sound is offered by the “High Resolution Audio” mode via the aptX™ Adaptive Bluetooth codec. The audio data is compressed and transmitted with a sampling frequency of 96 kHz and a sampling depth of 24 bits.

This mode requires an audio source (player or Bluetooth device) that supports aptX™ Adaptive and audio material in High Resolution quality.

If the “High Resolution Audio” mode is activated via the Smart Control app, the Bluetooth transmission range may be slightly reduced.

“Lossless Audio” mode

The “Lossless Audio” mode offers maximum sound quality. The audio data is transmitted uncompressed and bit-accurate in CD quality via the Bluetooth codec aptX™ Lossless, with a sampling frequency of 44.1 kHz and a sampling depth of 16 bits.

A correspondingly high-resolution quality of the audio material to be played back is required.

If the “Lossless Audio” mode is activated via the Smart Control app, the Bluetooth transmission range may be slightly reduced.

“Low Latency” mode

Your earbuds feature latency compensation as standard. The “Low Latency” mode can also be used to reduce the latency between the audio and video signal (e.g. when streaming video on your smartphone) to a minimum.

You can use this mode for all Bluetooth codecs.

If the “Low Latency” mode is activated via the Smart Control app, the Bluetooth transmission range may be slightly reduced.

Setting the voice prompts/beep sounds

To be able to set the voice prompts and beep sounds, you require the Smart Control app (> 23).

You can choose between voice prompts and beep sounds, or deactivate the status messages with a few exceptions (e.g. rechargeable battery is empty). Note that both earbuds must be switched on to adjust the settings for both earbuds (right and left).

Customizing the control functions

To be able to customize the control functions for music playback, you require the Smart Control app (> 23).

The app allows you to customize the control functions and other commands of the earbuds, to select preset control functions or to switch off the control functions. Some basic functions cannot be changed (e.g. call control).

Storing or transporting the earbuds in the charging case

ATTENTION

Moisture and dirt can damage the electronics of the charging case and the earbuds!

If moisture and dirt get inside the charging case, this can impair its function.

- ▷ Do not place the earbuds in the charging case when they are wet or dirty.

Store the earbuds in the charging case to prevent damage to the earbuds when not in use or during transport. The earbuds are automatically charged in the charging case so you always have the full battery life to work with.

- ▷ Open the charging case by overcoming a slight magnetic resistance and insert the left earbud into the left charging compartment and the right earbud into the right charging compartment. The earbuds are magnetically pulled into the charging compartments.
- ▷ Close the lid of the charging case.

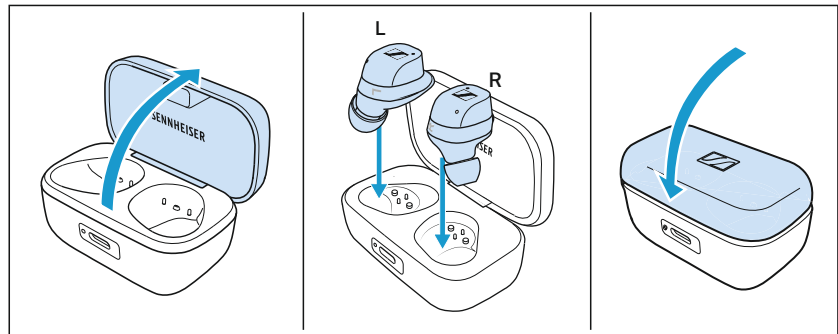

Care and maintenance of the earbuds/charging case

ATTENTION

Liquids can damage the electronics of the product!

Liquids entering the housing of the product can cause a short-circuit and damage the electronics.

- ▷ Keep all liquids far away from the product.
- ▷ Do not use any solvents or cleansing agents.

- ▷ Only clean the charging case with a soft, dry cloth.
- ▷ Clean the earbuds with a slightly damp cloth.

If you notice that the sound quality of the earbuds is deteriorating due to clogging:

- ▷ Remove the ear adapters from the earbuds' in-ear sound tunnels.
- ▷ Using a dry, clean brush (e.g. toothbrush), lightly brush over the in-ear sound tunnel openings to remove any dirt above the protective fabric. Avoid damaging the protective fabric within the in-ear sound tunnels to prevent dirt or debris from entering the electronics.

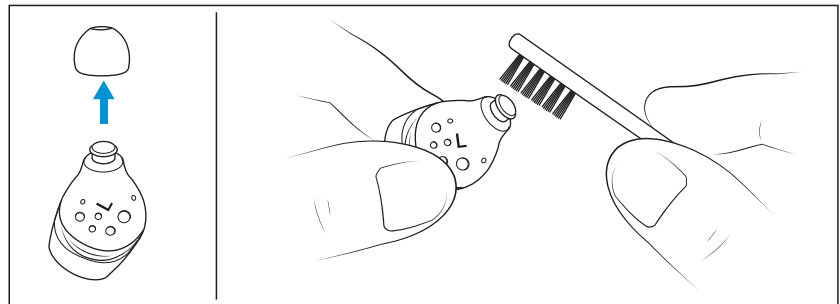

- ▷ You can clean the silicone ear adapters and silicone ear fins under lukewarm running water. Let the ear adapters and ear fins dry at room temperature for at least 12 hours before re-attaching them to the earbuds.

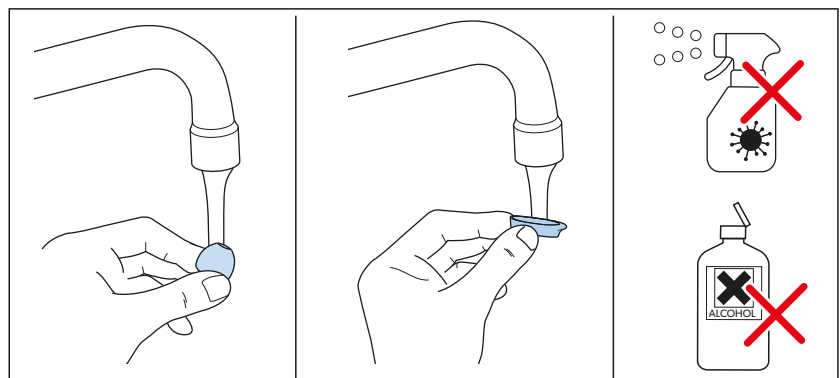

Care and maintenance of the earbuds/charging case

- ▷ Clean the charging contacts on the earbuds and in the charging case from time to time, e.g. with a cotton swab.

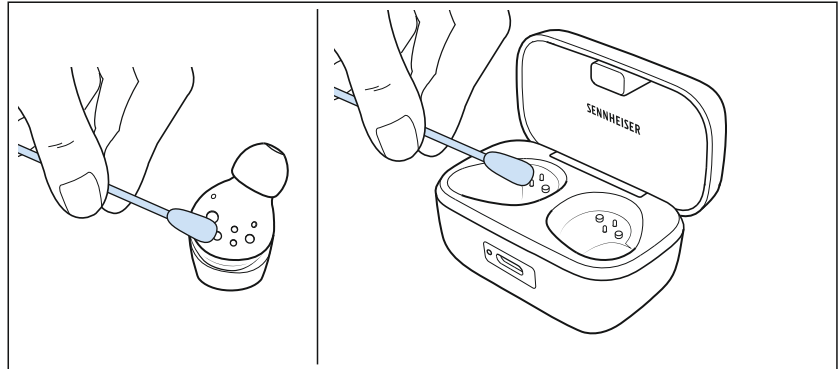

To remove any dirt such as dust accumulation or lint from the USB socket of the charging case:

- ▷ Blow into the USB socket or carefully brush a fine object (e.g. a toothpick or the bristles of a toothbrush) through the opening of the socket.

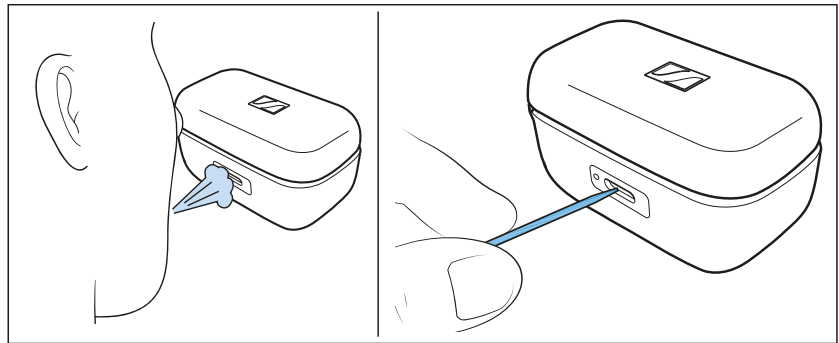

If the earbuds have gotten wet:

- ▷ Remove the ear adapters and dry the earbuds and ear adapters with a dry cloth. If necessary, let the earbuds and ear adapters dry at room temperature for approx. 12 hours.

Replacing the ear adapters and ear fins

For reasons of hygiene, you should replace your ear adapters (> 26) and ear fins (> 27) from time to time. Spare ear adapters and spare ear fins can be found on the MOMENTUM True Wireless 4 product page at www.sennheiser-hearing.com.

i You can use the Fit Test function in the Smart Control app to test the fit of the earbuds in your ears.

- ▷ Pull the ear adapter away from the in-ear sound tunnel.
- ▷ Mount the new ear adapter to the in-ear sound tunnel. Ensure that it locks into place.
- ▷ Carefully remove the ear fin from the earbud housing.
- ▷ Slip the new ear fin onto the earbud. Make sure that the latch on the inside of the ear fin ring is placed in the recess provided on the earbud housing.

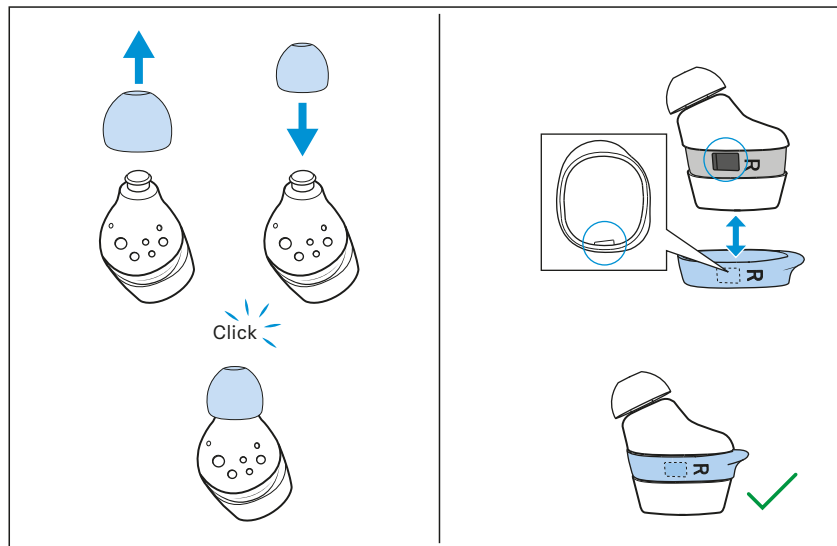

Information on the built-in rechargeable battery

Sonova Consumer Hearing ensures and guarantees that the rechargeable batteries perform at their optimum upon purchase of the product. If, upon purchase or within the warranty period, you suspect that a rechargeable battery is obviously defective or if a charging error/battery error is displayed (> 8), stop using the product, disconnect it from the power supply system and contact your Sonova Consumer Hearing partner. Your Sonova Consumer Hearing partner will coordinate the repair/replacement with you.

Do not return a product with a defective battery to your dealer or Sonova Consumer Hearing partner unless requested to do so. To find a partner in your country, search at

www.sennheiser-hearing.com/service-support.

At the end of its operational lifetime, this product with its built-in rechargeable battery must be disposed of separately from normal household waste. You can find more information here: > 50.

 In the Smart Control app, you can activate the battery protection mode, which ensures gentle charging and thus longer battery life (> 38).

Installing firmware updates

Firmware updates can be downloaded free of charge from the Internet using the Sennheiser Smart Control app.

- ▷ Make sure that the rechargeable batteries are fully charged before updating (> 17).
- ▷ Take the earbuds out of the charging case before updating and do not reinsert them into the charging case during the update.
- ▷ Connect your earbuds to your smartphone and start the Smart Control app (> 23).
The app provides information on available firmware updates and guides you through the installation process.
- ▷ Avoid connecting or disconnecting the USB power supply during the update process.

FAQ/If a problem occurs ...

If a problem has occurred, proceed in the following order until the problem is solved and you can use the earbuds again:

1. Insert the earbuds into the charging case and close the lid. Wait for at least 10 seconds (> 46).
2. Connect the earbuds to the Smart Control app to install the latest firmware (> 44).
3. Reset the earbuds to the factory default settings (> 47).
4. Check the list of frequently asked questions to see if there is a solution to the problem (> 45).
5. Contact your Sonova Consumer Hearing partner to solve the problem (> 45).

Current list of frequently asked questions (FAQ)



Visit the MOMENTUM True Wireless 4 product page at

www.sennheiser-hearing.com

There you will find a current list of frequently asked questions (FAQ) and suggested solutions.

Your question has not been answered or the problem persists?

If a problem occurs that is not listed in the FAQ section or if the problem cannot be solved with the proposed solutions, please contact your Sonova Consumer Hearing partner for assistance.

To find a partner in your country search at

www.sennheiser-hearing.com/service-support

Leaving the Bluetooth transmission range

Wireless calling and streaming are only possible in the Bluetooth transmission range of your smartphone. The transmission range largely depends on environmental conditions such as wall thickness, wall composition etc. With a free line of sight, the transmission range of most smartphones and Bluetooth devices is up to 10 meters.

If you, and therefore the earbuds, leave the Bluetooth transmission range of your Bluetooth device, the sound quality deteriorates increasingly until you hear the voice prompt “No connection” and the connection breaks down completely. If you immediately re-enter the Bluetooth transmission range of your device, the connection is automatically re-established and you hear the voice prompt “Connected”. If this is not the case, tap the touch control panel of one earbud 1x.

If you are using Auracast™ and you leave the radio range of the Auracast™ transmitter with your Bluetooth device, the connection and audio transmission will also be interrupted. If you re-enter the range of a previously paired Auracast™ transmitter, the Bluetooth wireless connection is re-established and the audio transmission starts automatically.



The Bluetooth transmission is also affected if you have activated a special audio transmission mode for your earbuds. In “High Resolution Audio” mode and in “Lossless Audio” mode, the stability of the Bluetooth connection may be reduced. The “Low Latency” mode can cause a reduced transmission range.

Resetting the earbuds

If the function of the earbuds is disturbed, perform a reset. Individual settings such as the pairing settings are not deleted.

- ▷ Insert the earbuds into the charging case and close the lid. After 10 seconds, the earbuds will restart (reset).

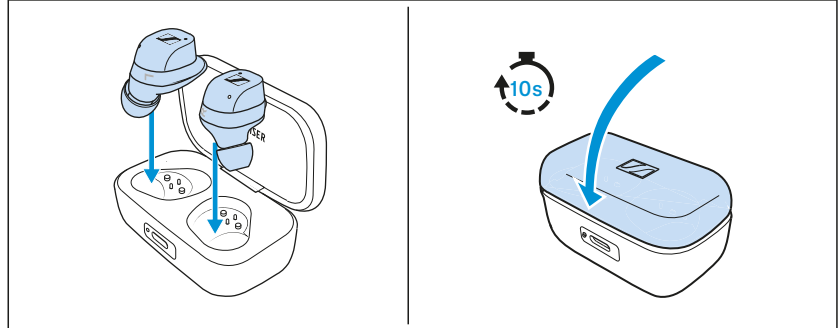

Resetting the earbuds to the factory default settings

If the function of the earbuds is disturbed and a reset (> 46) does not improve, reset the earbuds to the factory default settings. This deletes, among other things, all pairing settings.

The easiest way to reset the earbuds to the factory default settings is using the Smart Control app.

Alternatively, you can manually proceed as follows:

1. Disconnect all existing connections between Bluetooth devices and your earbuds, e.g. by deactivating Bluetooth on the devices. If you are connected to an Auracast™ transmitter, disconnect it via the Smart Control app (> 26).
 2. Insert one earbud into the charging case and close the lid of the charging case. The second earbud remains in the charging case.
 3. Tap and hold the touch control panel of the earbud that is not in the charging case for 15 seconds.
The LED on this earbud alternately lights up green and red (peer pairing mode).
 4. Take the second earbud out of the charging case.
 5. Tap and hold the touch control panel of the second earbud for 15 seconds.
The LED on this earbud alternately lights up green and red (peer pairing mode).
Both earbuds connect to each other within 15 seconds.
The earbuds are successfully reset to the factory settings and paired.
- ▷ Reconnect your earbuds to your Bluetooth device or an Auracast™ transmitter (> 22).

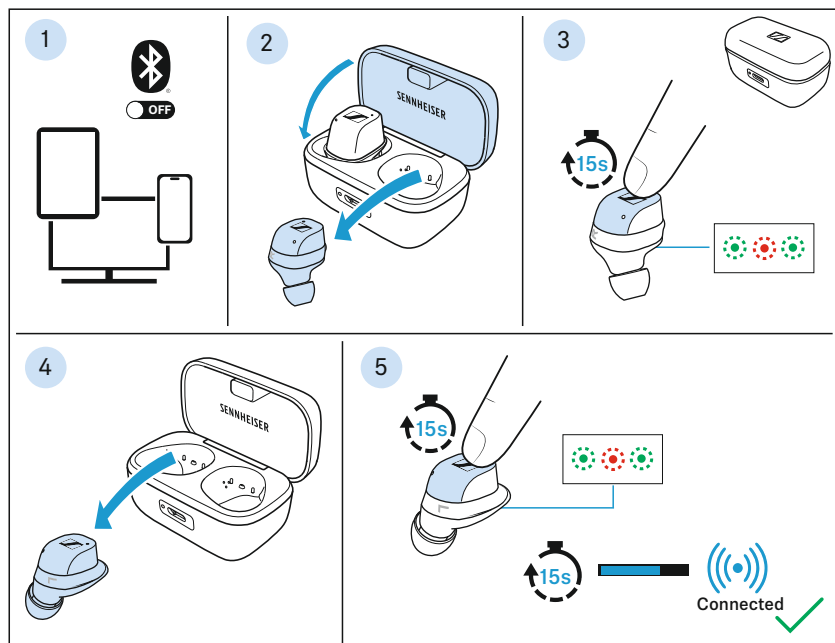

Specifications

MOMENTUM True Wireless 4

Model: MTW4, MTW4 R, MTW4 L, MTW4 C

Wearing style	True Wireless stereo earbuds
Ear coupling	ear-canal
Frequency response	5 Hz to 21 kHz
Transducer principle	dynamic
Transducer size	7 mm
Sound pressure level (SPL)	107 dB (1 kHz/1 mW)
THD (1 kHz, 94 dB SPL)	< 0.08 % (1 kHz/94 dB)
Noise cancellation	Hybrid Adaptive ANC technology
Microphone principle	MEMS
Microphone frequency response	100 Hz to 10 kHz
Microphone pick-up pattern (speech and ANC)	3 microphones per earbud beamforming array for active noise cancellation
Power supply	built-in lithium rechargeable batteries: earbuds (R and L): 3.6 V \approx , 75 mAh, 0.28 Wh or 3.8 V \approx , 72 mAh, 0.274 Wh charging case: 3.6 V \approx , 820 mAh, 2.952 Wh input: earbuds (R and L): 5 V \approx , max. 100 mA charging case: 5 V \approx , max. 1000 mA output: earbuds (R and L): none charging case: 5 V \approx , max. 100 mA x 2 (R and L)
Charging method via charging case	USB charging via USB-C socket: 5 V \approx , 1000 mA max; Qi wireless charging
Operating time	7.5 hrs with rechargeable battery of the earbud (ANC activated) 7 hrs with rechargeable battery of the earbud (ANC deactivated) 30 hrs with rechargeable battery of the charging case (test conditions: iPhone, volume at 50%)
Charging time of rechargeable batteries	approx. 1.5 hours for full charge approx. 8 minutes for 1 hour of music playback (ambient temperatures < 15 °C or > 30 °C and Qi wireless charging increase the charging time)

Temperature range	<i>operation:</i> 0 to +40 °C <i>charging:</i> +5 to +35 °C <i>storage:</i> -20 to +60 °C
Relative humidity	<i>operation:</i> 25 to 75 %, non condensing <i>storage:</i> 10 to 90 %
Magnetic field strength	earbuds: 0.95 mT charging case: 105 mT
Ingress protection of the earbuds	splash proof (IP54)
Weight	earbuds: approx. 6 g each charging case: approx. 66 g both earbuds and charging case: approx. 78 g

Bluetooth

Version	Bluetooth 5.4 certified, class 1
Transmission frequency	Classic BDR/EDR and BLE 1M: 2,402 MHz to 2,480 MHz BLE 2M: 2,404 MHz to 2,478 MHz (without 2,426 MHz)
Modulation	GFSK, $\pi/4$ DQPSK, 8DPSK
Profiles	AVRCP, A2DP, HFP, TMAP, PBP
Output power	10 mW (max)
Codec	aptX™, aptX™ Adaptive/Lossless, AAC, SBC, Auracast™ Broadcast Audio, LC3
Device name	MOMENTUM TW 4
Number of active connections	2

Manufacturer declarations

Warranty

Sonova Consumer Hearing GmbH gives a warranty of 24 months on this product.

For the current warranty conditions, please visit our website at www.sennheiser-hearing.com/warranty or contact your Sonova Consumer Hearing partner.

In compliance with the following requirements

- General Product Safety Directive (2001/95/EC)
- Compliant to **Sound Pressure Limits** according to country specific requirements

EU declaration of conformity



- RoHS Directive (2011/65/EU)

Hereby, Sonova Consumer Hearing GmbH declares that the radio equipment type MTW4 (MTW4 R, MTW4 L, MTW4 C) is in compliance with the directive 2014/53/EU.

The full text of the EU declaration of conformity is available at the following Internet address:

www.sennheiser-hearing.com/download

UK declaration of conformity



- RoHS Regulations (2012)
- Radio Equipment Regulations (2017)

Notes on disposal



- EU: WEEE Directive (2012/19/EU)
- EU: Battery Directive (2006/66/EC & 2013/56/EU)
- UK: WEEE Regulations (2013)
- UK: Battery Regulations (2015)

The symbol of the crossed-out wheeled bin on the product, the battery/rechargeable battery (if applicable) and/or the packaging indicates that these products must not be disposed of with normal household waste, but must be disposed of separately at the end of their operational lifetime. For packaging disposal, observe the legal regulations on waste segregation applicable in your country. Improper disposal of packaging materials can harm your health and the environment.

The separate collection of waste electrical and electronic equipment, batteries/rechargeable batteries (if applicable) and packagings is used to promote the reuse and recycling and to prevent negative effects on your health and the environment, e.g. caused by potentially hazardous substances contained in these products. Recycle electrical and electronic equipment and batteries/rechargeable batteries at the end of their operational lifetime in order to make contained recyclable materials usable and to avoid littering the environment.

If batteries/rechargeable batteries can be removed without damaging them, you are obliged to dispose of them separately (for the safe removal of batteries/rechargeable batteries, see the instruction manual of the product). Handle lithium-containing batteries/rechargeable batteries with special care, as they pose particular risks, such as the risk of fire and/or the risk of ingestion in the case of coin batteries. Reduce the generation of battery waste as much as possible by using longer-life batteries or rechargeable batteries.

Further information on the recycling of these products can be obtained from your municipal administration, from the municipal collection points, or from your Sonova Consumer Hearing partner. You can also return electrical or electronic equipment to distributors who have a take-back obligation. Herewith you make an important contribution to the protection of the environment and public health.

Trademarks

Apple, iPhone, the Apple logo and Siri are trademarks of Apple Inc., registered in the U.S. and other countries. App Store is a service mark of Apple Inc. The trademark “iPhone” is used in Japan with a license from Aiphone K.K.

Google Play and the Google Play logo are trademarks of Google LLC.

The Bluetooth® word mark and logos are registered trademarks owned by Bluetooth SIG, Inc. The Auracast™ word mark and logos are trademarks owned by the Bluetooth SIG, Inc. Any use of such marks by Sonova Consumer Hearing GmbH is under license.

Qualcomm® aptX™ is a product of Qualcomm Technologies International, Ltd. Qualcomm is a trademark of Qualcomm Incorporated, registered in the United States and other countries, used with permission.

aptX™ is a trademark of Qualcomm Technologies International, Ltd., registered in the United States and other countries, used with permission.

The Qi logo is a trademark of the Wireless Power Consortium.

Other product and company names mentioned in the user documentation may be the trademarks or registered trademarks of their respective holders.