

Operating Instructions LED TV

English

Model No.

TV-43W90AEB

TV-50W90AEB

TV-55W90AEB

TV-65W90AEB

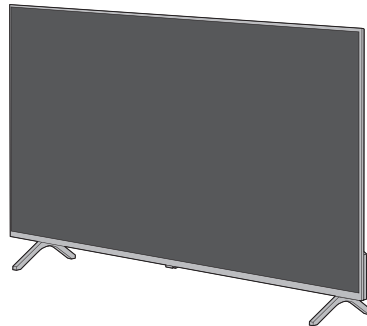

(image: TV-50W90AEB)

Refer to the following for more detailed descriptions:

- For settings to view broadcasts and for settings of programme guides, recording, image quality, sound quality, etc.:

 >  (on the screen) > [Device & Software] > [Panasonic eHELP]

- For Amazon, Fire TV, and Alexa related items:

 >  (on the screen) > [Help] (internet connection required)

Please be advised that the above may be changed without notice. (as of February, 2024)

Thank you for purchasing this Panasonic product.

Please read these instructions carefully before operating this product and retain them for future reference.

Please carefully read the "Safety Precautions" of this manual before use.

The images shown in this manual are for illustrative purposes only.

Contents

Be Sure to Read

Important Notice	3
Safety Precautions	4
Installing the wall-hanging bracket	8
Connections	8
Initial Setup	9
Identifying Controls	10
FAQs	12
Maintenance	13
Specifications	14

- Refer to the separate sheet for information about how to install the TV.
- Illustrations shown may be different depending on the model.
- This television is a product of Panasonic, which is not affiliated with Amazon.com, Inc. or any Amazon affiliate.
- You may need to be signed into an Amazon account in order to access certain online services.
- Certain services are subject to change or withdrawal at any time, may not be available in all countries, areas and languages, or in 4K, HDR, UHD, HLG, DOLBY VISION or DOLBY ATMOS and may require separate subscriptions.
- Because the Fire TV operating system is periodically updated, the images, navigation instructions, titles and location of menu options shown in this manual may be different from what you see on the screen.
- This document has been created based on information current as of February 2024.

The terms HDMI, HDMI High-Definition Multimedia Interface, HDMI Trade dress and the HDMI Logos are trademarks or registered trademarks of HDMI Licensing Administrator, Inc.

Dolby, Dolby Vision, Dolby Vision IQ, Dolby Atmos, Dolby Audio, and the double-D symbol are trademarks of Dolby Laboratories Licensing Corporation.

Manufactured under license from Dolby Laboratories.

Confidential unpublished works.

Copyright © 1992-2022 Dolby Laboratories.

All rights reserved.

Wi-Fi® is a registered trademark of Wi-Fi Alliance®.

WPA3™, WPA2™, WPA™ are trademarks of Wi-Fi Alliance®.

The Bluetooth® word mark and logos are registered trademarks owned by the Bluetooth SIG, Inc. and any use of such marks by Panasonic Holdings Corporation is under license.

DVB and the DVB logos are trademarks of the DVB Project.

x.v.Colour™ is a trademark.

DiSEqC™ is a trademark of EUTELSAT.

YouTube and the YouTube logo are trademarks of Google LLC.

Amazon, Prime Video, Fire and all related marks are trademarks of Amazon.com, Inc. or its affiliates.

© Disney

This product complies with the UHD Alliance Technical Specification: UHDA Specified Reference Mode, Version 1.0. FILMMAKER MODE™ logo is a trademark of the UHD Alliance, Inc. in the United States and other countries.

© 2022 Advanced Micro Devices, Inc. All rights reserved. AMD, the AMD Arrow logo, FreeSync and combinations thereof are trademarks of Advanced Micro Devices, Inc.

Important Notice

Notice for DVB / Data broadcasting / IPTV functions

- This TV is designed to meet the standards (as of February, 2024) of digital services.
- Not all the features are available depending on the country, area, broadcaster, service provider and network environment.
- Compatibility with future services is not guaranteed.

Internet apps, voice control function are provided by their respective service providers, and may be changed, interrupted, or discontinued at any time.

Panasonic assumes no responsibility and makes no warranty for the availability or the continuity of the services.

Panasonic does not guarantee operation and performance of peripheral devices made by other manufacturers; and we disclaim any liability or damage arising from operation and/or performance from usage of such other maker's peripheral devices.

Damages

- Excepting cases where responsibility is recognised by local regulations, Panasonic accepts no responsibility for malfunctions caused by misuse or use of the product, and other problems or damages caused by use of this product.
- Panasonic accepts no responsibility for the loss, etc., of data caused by disasters.
- External devices separately prepared by the customer are not covered by the warranty. Care for the data stored in such devices is the responsibility of the customer. Panasonic accepts no responsibility for abuse of this data.

Handling of customer information

Customer's personal information may be recorded on this TV by broadcasting organization or application provider. Before repairing, transferring or discarding this TV, erase all the information recorded on this TV according to the following procedure.

➔ [Reset to Factory Defaults] (p. 13)

Customer information may be collected by provider via application provided by third parties on this TV or website. Please confirm the terms and conditions etc. of provider in advance.

- Panasonic will not be held responsible for collecting or using customer information via application provided by third party on this TV or website.
- When entering your credit card number, name, etc., pay special attention to the trustworthiness of the provider.
- Registered information may be registered in the server etc. of provider. Before repairing, transferring or discarding this TV, be sure to erase the information according to the terms and conditions etc. of provider.

The recording and playback of content on this or any other device may require permission from the owner of the copyright or other such rights in that content. Panasonic has no authority to and does not grant you that permission and explicitly disclaims any right, ability or intention to obtain such permission on your behalf. It is your responsibility to ensure that your use of this or any other device complies with applicable copyright legislation in your country. Please refer to that legislation for more information on the relevant laws and regulations involved or contact the owner of the rights in the content you wish to record or playback.

This product is licensed under the AVC patent portfolio license for the personal use of a consumer or other uses in which it does not receive remuneration to (i) encode video in compliance with the AVC Standard ("AVC Video") and/or (ii) decode AVC Video that was encoded by a consumer engaged in a personal activity and/or was obtained from a video provider licensed to provide AVC Video. No license is granted or shall be implied for any other use.

Additional information may be obtained from MPEG LA, L.L.C.

See <http://www.mpegla.com>



This mark indicates the product operates on AC voltage.



This mark indicates the product operates on DC voltage.



This mark indicates a Class II or double insulated electrical appliance wherein the product does not require a safety connection to electrical earth (ground).

Transport only in upright position.

Safety Precautions

To help avoid risk of electrical shock, fire, damage or injury, please follow the warnings and cautions below:

■ Mains plug and lead

<Warning>

If you detect anything unusual, immediately switch off the mains supply switch and remove the mains plug.

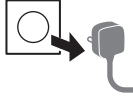

- Mains plug type may vary depending on the country.

- Insert the mains plug fully into the mains socket.
- When disconnecting the mains lead, be absolutely sure to disconnect the mains plug from the mains socket first.
- To turn Off the apparatus completely, you must pull the mains plug out of the mains socket.

Consequently, the mains plug should be easily accessible at all times.

- Disconnect the mains plug when cleaning the TV.
- Do not touch the mains plug with wet hands.



- Do not damage the mains lead.

- Do not place a heavy object on the lead.



- Do not place the lead near a high temperature object.



- Do not pull on the lead. Hold onto the mains plug body when disconnecting the plug.





- Do not move the TV with the lead plugged into a mains socket.
- Do not twist the lead, bend it excessively or stretch it.
- Do not use a damaged mains plug or mains socket.
- Ensure the TV does not crush the mains lead.
- Do not use any mains lead other than that provided with this TV.

IMPORTANT: THE MOULDED MAINS PLUG FOR YOUR SAFETY, PLEASE READ THE FOLLOWING TEXT CAREFULLY.

This TV is supplied with a moulded 3-pin mains plug for your safety and convenience.

A 13 amp fuse is fitted in this mains plug. Shall the fuse need to be replaced, please ensure that the replacement fuse has a 13 amp rating and that it is approved by ASTA or BSI to BS1362.

Check for the ASTA mark  or the BSI mark  on the fuse body.

If the mains plug contains a removable fuse cover, you must ensure that it is refitted when the fuse is replaced.

If you lose the fuse cover, the mains plug must not be used until a replacement cover is obtained.

A replacement fuse cover may be purchased from your local dealer.

Do not cut off the mains plug.

Do not use any other type of mains lead except the one supplied with this TV.

The supplied mains lead and moulded plug are designed to be used with this TV to avoid interference and for your safety.

If the mains socket in your home is not suitable, get it changed by a qualified electrician.

If the plug or mains lead becomes damaged, purchase a replacement from an authorised dealer.

How to replace the fuse:

For plug type shown in example 1

Lift out the removable fuse cover with a screwdriver and replace the fuse, then refit it securely into the mains plug.

Example 1



For plug type shown in example 2



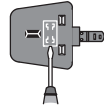

Lift open the fuse cover in the mains plug with a screwdriver and replace the fuse, then press the fuse cover down securely.

Example 2



■ Take care

<Warning>

- Do not remove covers and never modify the TV yourself as live parts are accessible and risk of electric shock when they are removed. There are no user serviceable parts inside.  
- Do not expose the TV to rain or excessive moisture. This TV must not be exposed to dripping or splashing water and objects filled with liquid, such as vases, must not be placed on top of or above the TV.  
- Do not insert foreign objects into the TV through the air vents.
- If the TV is used in an area where insects may easily enter the TV.

It is possible for insects to enter the TV, such as small flies, spiders, ants, etc. which may cause damage to the TV or become trapped in an area visible on the

TV, e.g. within the screen.

- If the TV is used in an environment where there is dust or smoke.

It is possible for dust/smoke particles to enter the TV through the air vents during normal operation which can become trapped inside the unit. This may cause overheating, malfunction, deterioration in picture quality, etc.

- Do not use an unapproved pedestal / mounting equipment. Be sure to ask your local Panasonic dealer to perform the setup or installation of approved wall-hanging brackets.
- Do not apply any strong force or impact to the display panel.
- Ensure that children do not climb on the TV.

- Do not place the TV on sloping or unstable surfaces, and ensure that the TV does not hang over the edge of the base.



Warning Stability Hazard

A TV may fall, causing serious personal injury or death. Many injuries, particularly to children, can be avoided by taking simple precautions such as:

- ALWAYS use cabinets or stands or mounting methods recommended by the manufacturer of the TV.
- ALWAYS use furniture that can safely support the TV.
- ALWAYS ensure the TV is not overhanging the edge of the supporting furniture.
- ALWAYS educate children about the dangers of climbing on furniture to reach the TV or its controls.
- ALWAYS route cords and cables connected to your TV so they cannot be tripped over, pulled or grabbed.
- NEVER place a TV in an unstable location.
- NEVER place the TV on tall furniture (for example, cupboards or bookcases) without anchoring both the furniture and the TV to a suitable support.
- NEVER place the TV on cloth or other materials that may be located between the TV and supporting furniture.
- NEVER place items that might tempt children to climb, such as toys and remote controls, on the top of the TV or furniture on which the TV is placed.

If the existing TV is going to be retained and relocated, the same considerations as above should be applied.

- This TV is designed for table-top use.
- Do not expose the TV to direct sunlight and other sources of heat.



To prevent the spread of fire, keep candles or other open flames away from this product at all times



■ Suffocation / Choking Hazard

<Warning>

- The packaging of this product may cause suffocation, and some of the parts are small and may present a choking hazard to young children. Keep these parts out of reach of young children.

■ Pedestal

<Warning>

- Do not disassemble or modify the pedestal.

<Caution>

- Do not use any pedestal other than the one provided with this TV.
- Do not use the pedestal if it becomes warped or physically damaged. If this occurs, contact your nearest Panasonic dealer immediately.
- During setup, make sure that all screws are securely tightened.
- Ensure that the TV does not suffer any impact during installation of the pedestal.
- Ensure that children do not climb onto the pedestal.
- Install or remove the TV from the pedestal with at least two people.
- Install or remove the TV according to the specified procedure.
- Insert the pedestal firmly, otherwise it may come off when setting up the TV.

■ Radio waves

<Warning>

- Do not use the TV and the remote control in any medical institutions or locations with medical equipment. Radio waves may interfere with the medical equipment and may cause accidents due to malfunction.
- Do not use the TV and the remote control near any automatic control equipment such as automatic doors or fire alarms. Radio waves may interfere with the automatic control equipment and may cause accidents due to malfunction.
- Keep at least 15 cm away from the TV and the remote control if you have a cardiac pacemaker. Radio waves may interfere with the operation of the pacemaker.
- Do not disassemble or alter the TV and the remote control in any way.

■ Built-in wireless LAN

<Caution>

- Do not use the built-in wireless LAN to connect to any wireless network (SSID*) for which you do not have usage rights. Such networks may be listed as a result of searches. However, using them may be regarded as illegal access.

*SSID is a name for identifying a particular wireless network for transmission.

- Do not subject the built-in wireless LAN to high temperatures, direct sunlight or moisture.
- Data transmitted and received over radio waves may be intercepted and monitored.

- The built-in wireless LAN uses 2.4 GHz, 5 GHz and 6 GHz frequency bands. To avoid malfunctions or slow response caused by radio wave interference when using the built-in wireless LAN, keep the TV away from other devices that use 2.4 GHz, 5 GHz and 6 GHz signals such as other wireless LAN devices, microwave ovens, and mobile phones.
- When problems occur due to static electricity, etc., the TV might stop operating to protect itself. In this case, turn off the TV by unplugging the mains plug, then turn on by inserting the mains plug into the mains socket.

■ Bluetooth® wireless technology

<Caution>

- The TV and the remote control use the 2.4 GHz radio frequency ISM band (Bluetooth®). To avoid malfunctions or slow response caused by radio wave interference, keep the TV and the remote control away from the devices such as other wireless LAN devices, other Bluetooth® devices, microwaves, mobile phones and the devices that use 2.4 GHz signal.

■ Ventilation

<Caution>

Allow sufficient space (at least 10 cm) around the TV in order to help prevent excessive heat, which could lead to early failure of some electronic components.

- Ventilation should not be impeded by covering the ventilation openings with items such as newspapers, tablecloths and curtains.
- Whether you are using a pedestal or not, always ensure the vents at the bottom of the TV are not blocked and there is sufficient space to enable adequate ventilation.



■ Moving the TV

<Caution>

Before moving the TV, disconnect all cables.

- At least two people are required to move the TV to prevent injury that may be caused by the tipping or falling of TV.
- There are parts such as switches on the bottom of the TV, so take care not to cause impacts to these by bumping on the floor, etc.

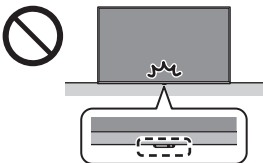

- Take out the pedestal and the TV from the packing case and put the TV onto a work table with the screen panel down on the clean and soft cloth (blanket, etc.).
 - Use a flat and firm table bigger than the TV.
- Make sure not to scratch or break the TV.

■ When not in use for a long time

<Caution>

This TV will still consume some power even in the Off mode, as long as the mains plug is still connected to a live mains socket.

- Remove the mains plug from the wall socket when the TV is not in use for a prolonged period of time.

■ Excessive volume

<Caution>

- Do not expose your ears to excessive volume from the headphones. Irreversible damage can be caused. 
- If you hear a drumming noise in your ears, turn down the volume or temporarily stop using the headphones.

■ Battery for the Remote Control

<Warning>

- Keep the batteries out of reach of children to prevent swallowing.

Adverse physical effects can result if accidentally swallowed. If you suspect a child has swallowed one, seek medical attention immediately.

<Caution>

- Incorrect installation may cause battery leakage, corrosion and explosion.
- Replace only with the same or equivalent type.
- Do not mix old and new batteries.
- Do not mix different battery types (such as alkaline and manganese batteries).
- Do not use rechargeable batteries (Ni-Cd, etc.).
- Do not burn or break up batteries.
- Do not expose batteries to excessive heat such as sunshine, fire or the like.
- Make sure you dispose of batteries correctly.
- Remove the battery from the unit when not using for a prolonged period of time to prevent battery leakage, corrosion and explosion.

LED TV

(For Great Britain)

UK Declaration of Conformity (DoC)

Hereby, Panasonic Entertainment & Communication Co., Ltd. declares that this TV is in compliance with the essential requirements and other relevant provisions of the Radio Equipment Regulations 2017 No.1206.

If you want to get a copy of the original DoC of this TV, please visit the following website:

<https://www.ptc.panasonic.eu/compliance-documents>

Contact in the UK:

Panasonic Testing Centre on behalf of Panasonic UK, a branch of Panasonic Marketing Europe GmbH (Importer) Maxis 2, Western Road, Bracknell, Berkshire, RG12 1RT

Importer for the UK:

Panasonic UK, a branch of Panasonic Marketing Europe GmbH, Maxis 2, Western Road, Bracknell, Berkshire, RG12 1RT



5.15 – 5.35 GHz and 5.925 – 6.425 GHz bands of wireless LAN is restricted to indoor operation only in the United Kingdom.

(For Ireland / Northern Ireland)

EU Declaration of Conformity (DoC)

Hereby, Panasonic Entertainment & Communication Co., Ltd. declares that this TV is in compliance with the essential requirements and other relevant provisions of the Directive 2014/53/EU.

If you want to get a copy of the original DoC of this TV, please visit the following website:

<https://www.ptc.panasonic.eu/compliance-documents>

Authorized Representative in EU:

Panasonic Marketing Europe GmbH
Panasonic Testing Centre
Winsbergring 15, 22525 Hamburg, Germany

Manufacturer:

Panasonic Entertainment & Communication Co., Ltd.
1-10-12 Yagumo-higashi-machi, Moriguchi City,
Osaka 570-0021, Japan

Made in China



5.15 – 5.35 GHz and 5.945 – 6.425 GHz bands of wireless LAN is restricted to indoor operation only in the following countries.

Ireland, United Kingdom (Northern Ireland)

Output power transmitted in the frequency bands

Type of wireless	Frequency band	Output Power (EIRP)
Wireless LAN	2412-2472 MHz	< 20 dBm
	5150-5250 MHz	< 23 dBm
	5250-5350 MHz	< 23 dBm
	5470-5725 MHz	< 23 dBm
	UK 5925-6425 MHz Ireland / UK (NI) 5945-6425 MHz	< 23 dBm
Bluetooth®	2402-2480 MHz	< 10 dBm

Disposal of Old Equipment and Batteries

Only for European Union and countries with recycling systems



These symbols on the products, packaging, and/or accompanying documents mean that used electrical and electronic products and batteries must not be mixed with general household waste.

For proper treatment, recovery and recycling of old products and used batteries, please take them to applicable collection points in accordance with your national legislation.

By disposing of them correctly, you will help to save valuable resources and prevent any potential negative effects on human health and the environment.

For more information about collection and recycling, please contact your local authority.

Penalties may be applicable for incorrect disposal of this waste, in accordance with national legislation.

Note for the battery symbol (bottom symbol):



This symbol might be used in combination with a chemical symbol. In this case it complies with the requirement set by the Directive for the chemical involved.

Installing the wall-hanging bracket

Please contact your local Panasonic dealer to purchase the recommended wall-hanging bracket.

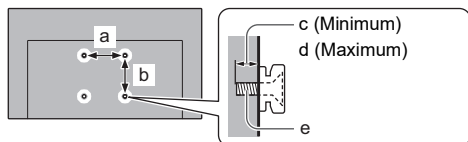

	a	b	c	d	e
	mm				
43-inch model	200	200	10	12	M6
50-inch model	200	200	12	17	M6
55-inch model	400	300	12	20	M6
65-inch model	400	300	12	20	M6

<Warning>

- Using other wall-hanging brackets, or installing a wall-hanging bracket by yourself have the risk of personal injury and product damage. In order to maintain the unit's performance and safety, be absolutely sure to ask your dealer or a licensed contractor to secure the wall-hanging brackets. Any damage caused by installing without a qualified installer will void your warranty.
- Carefully read the instructions accompanying optional accessories, and be absolutely sure to take steps to prevent the TV from falling off.
- Handle the TV carefully during installation since subjecting it to impact or other forces may cause product damage.
- Take care when fixing wall brackets to the wall. Always ensure that there are no electrical cables or pipes in the wall before hanging bracket.
- To prevent fall and injury, remove the TV from its fixed wall position when it is no longer in use.

Connections

Refer to [Panasonic eHELP] and the separate sheet for details about connections.

- Please ensure that the unit is disconnected from the mains socket before attaching or disconnecting any cables.
- Keep the TV away from electronic equipment (video equipment, etc.) or equipment with an infrared sensor, otherwise distortion of image / sound may occur or operation of other equipment may be affected.
- Please also read the manual of the equipment being connected.

Basic connections

■ AV devices

(DVD Recorder / Blu-ray Recorder, Cable TV box, etc.)

- For details, refer to [Panasonic eHELP] (Search by Purpose > Watching > Basic > Basic connection).

■ Aerial

(For viewing cable / digital broadcasts)

- For details, refer to [Panasonic eHELP] (Search by Purpose > Watching > Basic > Basic connection).

■ Satellite connection

To ensure your satellite dish is correctly installed, please consult your local dealer. Also consult the received satellite broadcasting companies for details.

- For details, refer to [Panasonic eHELP] (Search by Purpose > Watching > Basic > Satellite connection).

■ Network

A broadband network environment is required to be able to use internet services.

- If you do not have any broadband network services, please consult your retailer for assistance.
- Prepare the internet environment for wired connection or wireless connection.
- Setup of the network connection will start when first using the TV. ➔ (p. 9)
- For details, refer to [Panasonic eHELP] (Search by Purpose > Network > Network connections).

Connections for 4K / HDR compatible equipment

TV



① HDMI cable

② 4K / HDR compatible equipment

- Connect the 4K compatible equipment to HDMI terminal using a 4K compatible cable and you can watch content in 4K format.
- Set to [Mode1] when the image or sound in HDMI input is not played properly.
- Supporting HDR does not increase the peak brightness capabilities of the TV panel.

■ [HDMI Auto Setting]

Reproduces the image more precisely with the expanded colour gamut and more smoothly with the high frame rate when connecting the 4K compatible equipment. Select the mode depending on the equipment.

[Mode1]:

For better compatibility. Set to [Mode1] when the image or sound in HDMI input is not played properly.

[Mode2]:

For the 4K compatible equipment that has the function to output the image precisely with the expanded colour gamut.

[Mode3]:

For the 4K compatible equipment that has the function to output the high frame rate image.

(This mode is valid in HDMI 1 and 2)

● To change the mode

1. Select the HDMI input mode connected to the equipment.
2. Change the mode in [HDMI Auto Setting].

 > [Picture] > [HDMI Settings] > [HDMI Auto Setting]

- For information about the valid format, refer to [Panasonic eHELP] (Search by Purpose > Watching > 4K resolution > HDMI Auto Setting).

Other connections

■ Headphones / Subwoofer

Set [Headphone Jack] () > [] (on the screen) > [Display & Audio] > [Audio Output] to [Connect].

- To use headphones, set [Audio Output Mode] to [Headphone] or [TV Speaker and Headphone].
- To use subwoofer, set [Audio Output Mode] to [TV Speaker and Sub Woofer].



■ USB HDD (for recording)

- Use USB 1 port for connecting the USB HDD.
- For details, refer to [Panasonic eHELP] (Search by Purpose > Recording).

■ Common Interface

- Turn off the TV by unplugging the mains plug when inserting or removing the CI module.
- If a smart card and a CI module come as a set, first insert the CI module, then insert the smart card into the CI module.
- Insert or remove the CI module completely in the correct direction.
- Normally encrypted channels will appear. (Viewable channels and their features depend on the CI module.)

If encrypted channels do not appear

➔  > [] (on the screen) > [Live TV] > [Broadcast Options] > [Common Interface]

- There might be some CI modules in the market with older firmware versions that do not work fully interoperable with this new CI+ v1.4 TV. In this case, please contact your content provider.
- For details, refer to [Panasonic eHELP] (Search by Purpose > Functions > Common Interface), read the manual of the CI module, or check with the content provider.
- Be sure to remove the CI module card, etc. before repairing, transferring or discarding.

Initial Setup

A setup screen is displayed when you turn the TV on for the first time. Follow the on-screen guidance.

- 1 Choose Your Language
- 2 Choose Your Location
- 3 Select TV mode
 - It is recommended to select [Continue] for home use.
- 4 Pair Your Remote with your TV
 - Pairing of the remote control is completed automatically.
- 5 Enable Network
 - Select [Enable] to connect to the internet or select [Disable] when connection is not required.
 - When connecting wirelessly, select the access point to be connected to. To set up later, you can press the  button on the remote control to skip.
 - When using a wired connection, the internet connection is established automatically.
- 6 Sign In with Your Amazon Account
 - To use Amazon, Fire TV, and Alexa related functionality, you will need to sign into your Amazon account. Note that this step is skipped if there is no internet connection.
 - You can sign in with a smartphone, a QR code, or the remote control. Follow the on-screen guidance.
- 7 Scan for TV channels
 - Select [Start Auto Setup] to start the scan.
- 8 Parental Controls (PIN code)
 - Specifications, etc. are subject to change due to software updates.
 - You will need an internet connection and to sign into your Amazon account in order to use a variety of services such as voice controls and video streaming services.
 - If you set a PIN code, you may be asked to enter your PIN code when you try to access some menus, services, content, etc.

■ Home



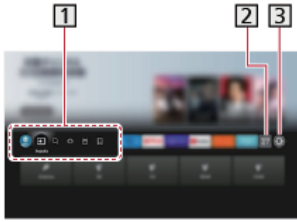

"Home" is a gateway to the TV programmes, applications and connected devices. Home is displayed by pressing

 and it provides you an easy way to access all the features as shown below (example).



1 Profile / Inputs / Search / Home / Live TV / My Stuff

- For example: to watch TV -









After selecting , press  on the remote control and select the channel with  

2 Applications

3 Setting menu

- Display the screen for making advanced settings for the TV.
- For details, refer to [Panasonic eHELP] (Search by Purpose > Functions > Home).

<Note>

- The TV goes into Standby mode when no operation is performed for 4 hours if [Auto Standby] ( >  (on the screen) > [Preferences] > [Eco mode]) is set to [ON] (factory setting).
- The TV goes into Standby mode when no signal is received and no operation is performed for 10 minutes if [No signal Power off] ( >  (on the screen) > [Preferences] > [Eco mode]) is set to [ON] (factory setting).
- To retune all channels
 - ➔  >  (on the screen) > [Live TV] > [Broadcast Options] > [Tuning Menu] > [Auto Setup]
- To add the available TV signal mode later
 - ➔  >  (on the screen) > [Live TV] > [Broadcast Options] > [Set up TV Signals]
- To initialise all settings
 - ➔ [Reset to Factory Defaults] (p. 13)

Identifying Controls

Remote Control

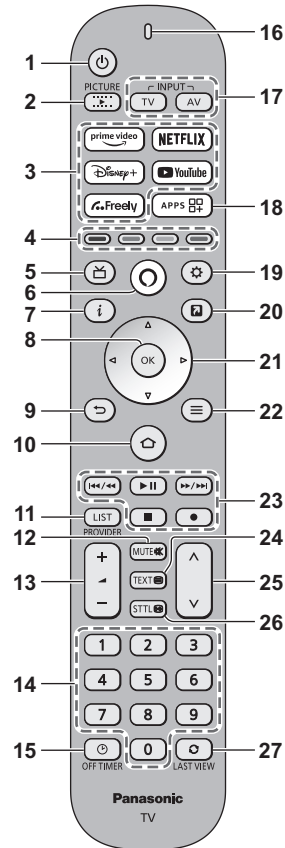

1 : Switches TV On or Off (Standby)

2 Viewing mode

3 Streaming Service

4 Coloured buttons
(red-green-yellow-blue)

5 TV Guide

6 Alexa Voice Button

- Press and hold the button and speak into the microphone to use voice controls.
- Certain Alexa Skills and features may not be available in all countries or languages, and are subject to change at any time.
- Whether Alexa responds or not depends on the volume/tone of your voice and the ambient noise.
- To perform searches and other functions, this device needs to be connected to the internet.

7 Information

8 OK

9 Return

10 Home ➔ (p. 10)

11 PROVIDER/LIST

12 Sound Mute On / Off

13 Volume Up / Down

14 Numeric buttons

15 Off Timer

16 Microphone

LED indicator

- Lights in different colours when using the remote control.

17 Input mode selection

18 Applications list

19 Quick Settings

- Displays quick settings such as Picture and Screen on the screen.

20 MY APP (Assigns a favourite application.)

21 Cursor buttons

22 Menu

23 Operations for contents, connected equipment, etc.

24 Text service

25 Channel Up / Down

26 Subtitles

27 Last view

Indicator / Control panel

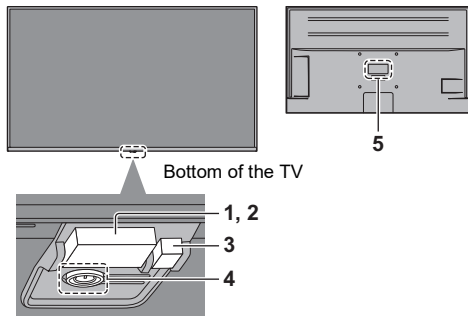

1 Remote control signal receiver (for infrared communication)

- Do not place any objects between the TV remote control signal receiver and remote control.

2 Ambient sensor

- Senses ambient lighting conditions to adjust the picture when [Auto Brightness] and [Auto White Balance] (> [Picture] > [Ambient Sensor]) are set to [On].

3 Power LED

Red: Standby

Green: On

- Depending on the ambient brightness, adjusts the brightness of LED to easy-to-view levels automatically.

Orange: Standby with some functions (recording, etc.) active

4 Power button

- Press the button to turn on.
- When the TV is on, press the button to display the operation guide.
The item selection switches between Power Off, Inputs*, Volume Up-Down, Channel Up-Down, and Exit each time you press the Power button, and pressing and holding for about 2 seconds enables item operation.
- * Press the button to select the input when the input selection list appears. Press and hold the button to confirm.
- To Power Off (Standby) with the button on the TV itself, press and hold the Power button for about 2 seconds while Power Off is selected.
- To turn Off the apparatus completely, you must pull the mains plug out of the mains socket.
- : Standby / On (Bottom of the TV)

5 Model name plate

Bluetooth® device

Pairing Bluetooth® devices

This TV supports Bluetooth® communications.

Bluetooth® devices that have been registered (paired) with this TV can connect to (communicate with) this TV.

- When registering (pairing) a Bluetooth® device with this TV, move the device within 50 cm of the TV.
- It is not possible to register (pair) Bluetooth® devices that are not compatible with this TV.
- If a Bluetooth® enabled device that you have registered (paired) with this TV is then registered and used on another device, it may then be made unavailable for use with this TV. Register the device on this TV again if this occurs.
- You can register Bluetooth® audio devices that support A2DP on this TV. Due to the characteristics of wireless technology, there will be some delay between the playback of video and audio.

It is not possible to use more than one audio device that supports A2DP simultaneously.

- For details, refer to [Panasonic eHELP] (Search by Purpose > Functions > Bluetooth devices).

Pairing the remote control



Either Bluetooth® wireless technology or the infrared communication function can be used for the transmissions between the TV and the remote control.

Since voice controls (p. 10) use Bluetooth® wireless technology, the remote control needs to be registered (paired) with the TV.

- When using the remote control for the first time after purchase, when you press any button while pointing the remote control at the remote control signal receiver with batteries inserted, the remote control is automatically registered (paired).
- When registering, face the remote control at the remote control signal receiver on the TV, within about 50 cm.
- Registration may not be completed correctly if the batteries in the remote control are running low.

■ Registering a remote control

Select **[Add New Remote]** with the following procedure and follow the on-screen guidance:

 >  (on the screen) > [Remotes & Bluetooth Devices] > [Voice Remotes with Alexa] > [Add New Remote]

If you have problems in pairing the Bluetooth remote control, you need to reset it and try again.

- 1 Press and hold the buttons shown below simultaneously for about 12 seconds.





- 2 Release the buttons and wait 5 seconds.
- 3 Remove the batteries and insert them back.

<Note>

- If the remote control is registered (paired) with the TV, they communicate via Bluetooth®. You will not need to face the remote control at the TV's remote control signal receiver when Bluetooth® communication is used.

FAQs

Before requesting service or assistance, please follow these simple guides to solve the problem.

- For details, refer to [Panasonic eHELP] (Support > FAQs).
- Try restarting the TV.
 -  >  (on the screen) > [Device & Software] > [Restart]
 - Press and hold the Power button on the TV for 15 seconds or more.

The TV does not switch on

- Check the mains lead is plugged into the TV and the mains socket.
- The fuse in the mains plug may have blown. Replace it with one of an identical rating. ➔ (p. 4)

The TV goes into Standby mode

- Auto power standby function is activated.

The remote control does not work or is intermittent





- Has the remote control been paired with the TV via Bluetooth®? ➔ (p. 12)
- Are the batteries installed correctly?
- The batteries may be running low. Replace them with new ones.
- Operation of the remote control is not possible due to system startup when the LED is blinking orange. You can use the remote control after the LED turns constant red.
- Point the remote control directly at the TV's remote control signal receiver (within about 7 m and a 30 degree angle of the signal receiver).*
- Situate the TV away from sunshine or other sources of bright light so they do not shine on the TV's remote control signal receiver.*

* When infrared communication is used

No image is displayed

- Check the TV is turned on.
- Check the mains lead is plugged into the TV and the mains socket.
- Check the correct input mode is selected.
- Is [Luminance Level] or [Contrast] set to the minimum?
 - ➔  > [Picture] > [Brightness]
- Check all required cables and connections are firmly in place.

An unusual image is displayed

- This TV has a built-in Self Test. Makes a diagnosis of picture or sound problems.
 - ➔  >  (on the screen) > [Device & Software] > [TV Self Test]
- Turn off the TV by unplugging the mains plug, then turn on by inserting the mains plug into the mains socket.
- If the problem persists, initialise all settings.
 - ➔  >  (on the screen) > [Device & Software] > [Reset to Factory Defaults]
 - When initialising, you can choose whether to delete or keep the recorded programmes.

The image or sound from external equipment are unusual when the equipment is connected via HDMI

- Set [HDMI Auto Setting] to [Mode1]. ➔ (p. 9)

No sound is produced from the connected HDMI equipment

- Set the audio output format of the connected HDMI equipment to PCM.

Voice control function does not work

- Has the remote control been paired with the TV via Bluetooth®? ➔ (p. 12)
- Check the network connections and settings.

Parts of the TV become hot

- Parts of the TV may become hot. These temperature rises do not pose any problems in terms of performance or quality.

When pushed with a finger, the display panel moves slightly and makes a noise

- There is a little gap around the panel to prevent damage to the panel. This is not a malfunction.

About the inquiry

- Please contact your local Panasonic dealer for assistance.

If you make an inquiry from a place where this TV is not present, we cannot answer about contents that require visual confirmation for connection, phenomenon, etc. of this TV itself.

Maintenance

First, remove the mains plug from the mains socket.

Display panel, Cabinet, Pedestal

Regular care:

Gently wipe the surface of the display panel, cabinet, or pedestal by using a soft cloth to remove dirt or fingerprints.

For stubborn dirt:

- (1) First clean the dust from the surface.
- (2) Dampen a soft cloth with clean water or diluted neutral detergent (1 part detergent to 100 parts water).
- (3) Wring out the cloth firmly. (Please note, do not let liquid enter the TV inside as it may lead to product failure.)
- (4) Carefully wipe moisten and wipe away the stubborn dirt.
- (5) Finally, wipe away all the moisture.

<Caution>

- Do not use a hard cloth or rub the surface too hard, otherwise this may cause scratches on the surface.
- Take care not to subject the surfaces to insect repellent, solvent, thinner or other volatile substances. This may degrade surface quality or cause peeling of the paint.
- The surface of the display panel is specially treated and may be easily damaged. Take care not to tap or scratch the surface with your fingernail or other hard objects.
- Do not allow the cabinet and pedestal to make contact with a rubber or PVC substance for a long time. This may degrade surface quality.

Mains plug

Wipe the mains plug with a dry cloth at regular intervals. Moisture and dust may cause fire or electrical shock.

Specifications

■ TV

Model No.

43-inch model : TV-43W90AEB

50-inch model : TV-50W90AEB

55-inch model : TV-55W90AEB

65-inch model : TV-65W90AEB

Power source

AC 220-240 V, 50 / 60 Hz

Panel

LED backlight Liquid Crystal Display

Sound

Speaker output

20 W (10 W × 2)

Headphones / Subwoofer

3.5 mm stereo mini jack × 1

Connection terminals

HDMI 1 / 2 / 3 / 4 input

TYPE A Connectors

HDMI 1:

4K144Hz, VRR (Variable Refresh Rate),
AMD FreeSync™ Premium, Content Type,
Deep Colour, x.v.Colour™

HDMI 2:

4K144Hz, VRR (Variable Refresh Rate),
AMD FreeSync™ Premium, Content Type,
eARC (Enhanced Audio Return Channel) /
ARC (Audio Return Channel), Deep Colour,
x.v.Colour™

HDMI 3 / 4:

4K, Content Type, Deep Colour, x.v.Colour™

- This TV supports "HDAVI Control 5" function.

Card slot

Common Interface slot (complies with CI Plus) × 1

ETHERNET

RJ45, IEEE802.3 10BASE-T / 100BASE-TX

- Use Shielded Twist Pair (STP) LAN cable.

USB 1 / 2

USB 1:

DC ≡ 5 V, Max. 900 mA [SuperSpeed USB (USB 3.0)]

USB 2:

DC ≡ 5 V, Max. 500 mA [Hi-Speed USB (USB 2.0)]

DIGITAL AUDIO output

PCM / Dolby Audio, Fibre optic

Receiving systems / Band name

Satellite

DVB-S / S2

Receiver IF frequency range - 950 MHz to 2150 MHz

Digital

DVB-T / T2, DVB-C

Channel coverage: UHF / VHF / Cable

Satellite dish input

Female F-type 75 Ω × 1

Aerial input

UK

UHF

Ireland

VHF / UHF

Operating conditions

Temperature

0 °C - 35 °C

Humidity

20 % - 80 % RH (non-condensing)

Built-in wireless LAN

Standard compliance and Frequency band

IEEE802.11ax: 6 GHz band

IEEE802.11a/n/ac/ax: 5 GHz band

IEEE802.11b/g/n/ax: 2.4 GHz band

Security

WPA3-SAE (AES)

WPA2-PSK (TKIP/AES)

WPA-PSK (TKIP/AES)

WEP (64 bit/128 bit)

Bluetooth® wireless technology*

Standard Compliance and Frequency band

Bluetooth® 5.3: 2.4 GHz band

- * Not all the Bluetooth® compatible devices are available with this TV. Up to 5 devices can be used simultaneously.

<Note>

- Design and Specifications are subject to change without notice. Mass and Dimensions shown are approximate.
- For information about the open source software, refer to [Panasonic eHELP] (Search by Purpose > Read first > Before use > Licence).

Customer's Record

The model number and serial number of this product may be found on its rear panel. You should note this serial number in the space provided below and retain this book, plus your purchase receipt, as a permanent record of your purchase to aid in identification in the event of theft or loss, and for Warranty Service purposes.

Model Number

Serial Number



Sales and Support Information

Customer Communications Centre

- For customers within the UK: **0344 844 3899**
- For customers within Ireland: **+353 1 912 4459**
- Monday – Friday 9:00am – 5:00pm, (Excluding public holidays).
- For further support on your product, please visit our website: **www.panasonic.co.uk**

Direct Sales at Panasonic UK

- Order accessory and consumable items for your product with ease and confidence by phoning our Customer Communications Centre Monday – Friday 9:00am – 5:00pm, (Excluding public holidays).
- Or go on line through our Internet Accessory ordering application at **www.pas-europe.com**.
- Most major credit and debit cards accepted.
- All enquiries transactions and distribution facilities are provided directly by Panasonic UK.
- It couldn't be simpler!
- Also available through our Internet is direct shopping for a wide range of finished products. Take a browse on our website for further details.



Panasonic UK, a branch of Panasonic Marketing Europe GmbH
Maxis 2, Western Road, Bracknell, Berkshire, RG12 1RT, United Kingdom
Web Site: <http://www.panasonic.com>