



SONY

CINEMA IS COMING HOME

Home Cinema Projector 2024



The ultimate cinema experience comes home

NEW



Color : Black/White



Bring the authentic big screen home

NEW



Color : Black/White



BRAVIA Projector 9

VPL-XW8100ES



BRAVIA Projector 8

VPL-XW6100ES

BRAVIA Projector 9

VPL-XW8100ES

Laser with ACF-Lens | 4K HDR | 3,400 lm

See every movie in a new light with the ultimate home cinema experience powered by our XR Processor for projector. Enjoy precision and clarity with rich gradation, deep blacks, and brilliant colours, enhanced by our class-leading laser light source.

BRAVIA Projector 8

VPL-XW6100ES

Laser with ACF-Lens | 4K HDR | 2,700 lm

Bring every movie to life at home on the big screen powered by our XR Processor for projector and our class-leading laser light source. Enjoy precision and clarity with rich gradation, deep blacks, and brilliant colors.

Bring home entertainment with a native 4K, high-value laser projector



Color : Black/White



VPL-XW5000ES

Laser | 4K HDR | 2,000 lm

Bring the action home with up to 2,000 lumens of high brightness, generated by a long-lasting laser light source, for vibrant images even on a large screen.

Ultimate 4K SXRD™ 10,000lm Laser Projector







VPL-GTZ380

ARC-F Lens* | 4K HDR | 10,000 lm

The Sony VPL-GTZ380 is the world's most advanced projector designed for large home cinemas to bring a true theater experience home. An exceptional 10,000 lumens of brightness with 100% DCI-P3 wide color gamut is perfect for the largest and most lavishly equipped home cinema rooms.

*The ARC-F lens is optional.

Sony Home Cinema Projector Lineup

	4K HDR LASER PHOSPHOR PROJECTOR			
	NEW  Color : Black/White	NEW  Color : Black/White	 Color : Black/White	
Model	BRAVIA Projector 9 VPL-XW8100ES	BRAVIA Projector 8 VPL-XW6100ES	VPL-XW5000ES	VPL-GTZ380
Brightness	3,400lm	2,700 lm	2,000 lm	10,000 lm
Picture Engine	XR Processor for projector	XR Processor for projector	X1 Ultimate for projector	X1 Ultimate for projector
Light Source Enhancer	Laser	Laser	Laser	Laser
Resolution	Native 4K	Native 4K	Native 4K	Native 4K
Lens (Bundled)	ACF-Lens	ACF-Lens	Standard 4K Lens	-
Dynamic Contrast	∞:1	∞:1	∞:1	∞:1
Color space	95% DCI-P3 XR Triluminos Pro	95% DCI-P3 XR Triluminos Pro	95% DCI-P3 Triluminos Pro	100% DCI-P3 Triluminos Pro
Screen Adjustment	Picture Position + Keystone	Picture Position + Keystone	-	Picture Position
Accessories Lens (Optional)	-	-	-	VPLL-Z8014 (Standard ARC-F) VPLL-Z8008 (Short throw)

Picture Quality

High brightness technology with
XR Processor for projector



Bring every movie to new life with the ultimate home cinema experience powered by our XR Processor for projector and our class-leading laser light source. Enjoy precision and clarity with rich gradation, deep blacks, and brilliant colors.

XR Processor for Projector

XR Dynamic Tone Mapping

XR Dynamic Tone Mapping optimizes brightness frame by frame, ensuring perfect gradation and contrast while keeping creator's intent.

*BRAVIA Projector 9 / BRAVIA Projector 8 only

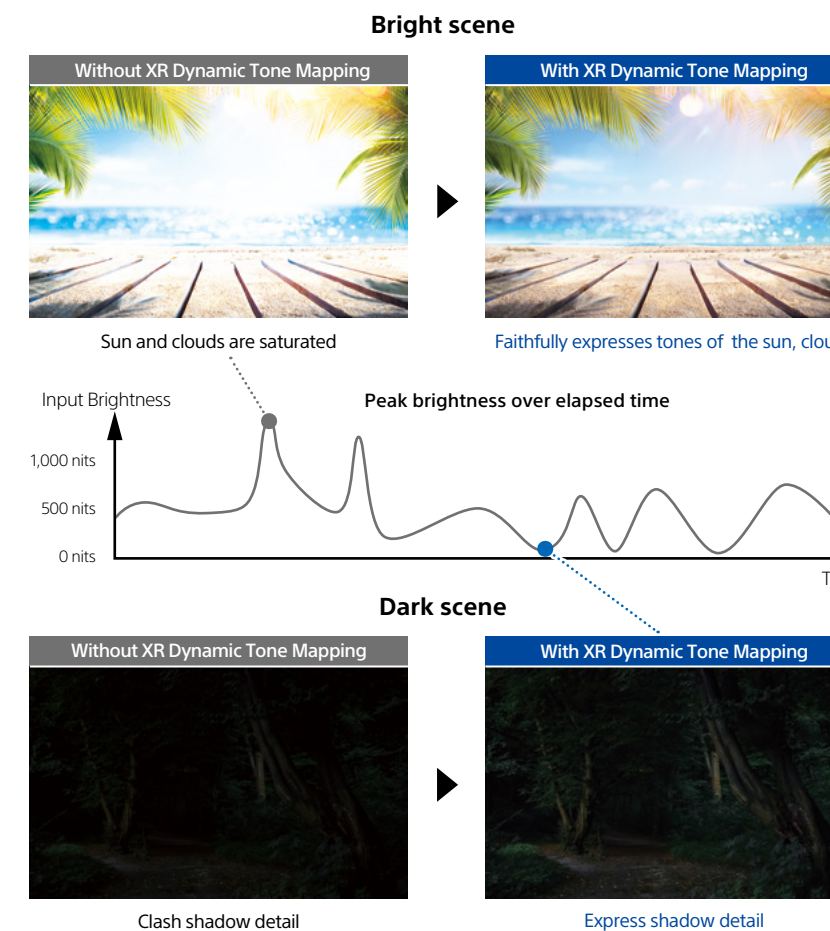

XR Deep Black

XR Deep Black technology enhances dark scenes with deeper blacks and precise color expression by controlling laser dimming in dark scenes and optimizing highlight processing.

*BRAVIA Projector 9 / BRAVIA Projector 8 only

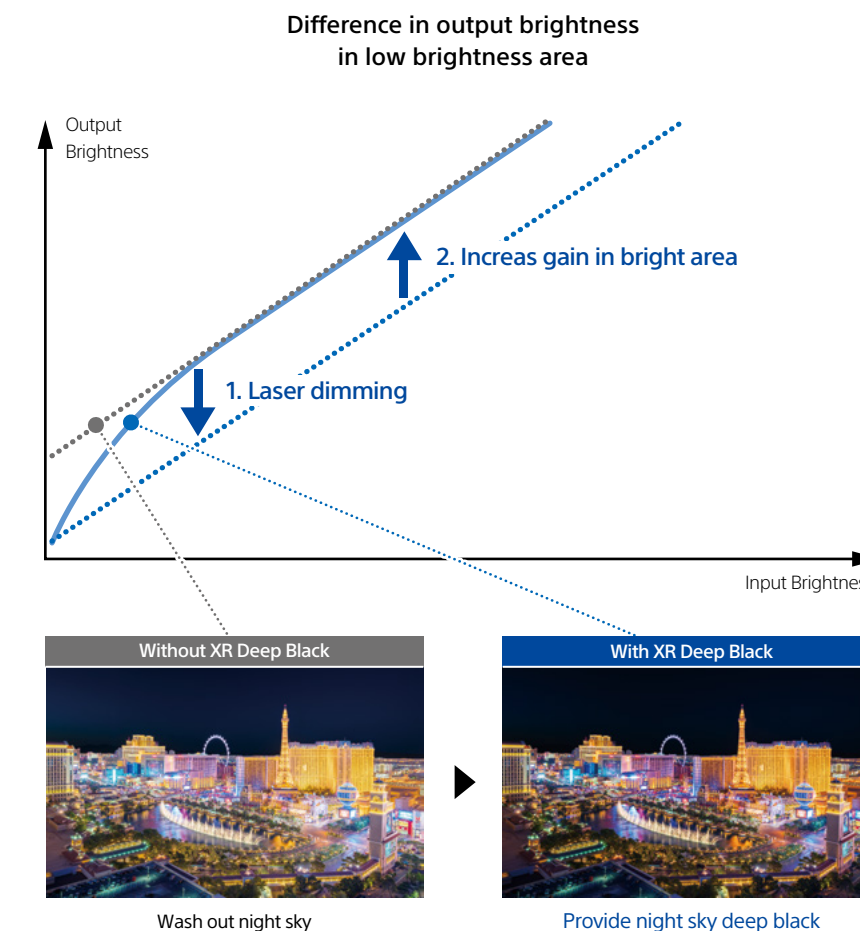

XR Triluminos Pro

XR Triluminos Pro brings over a billion colors to life.

*BRAVIA Projector 9 / BRAVIA Projector 8 only



Without XR Triluminos Pro

With XR Triluminos Pro

Wide color gamut and High brightness

This combined with high brightness and expanded color volume delivers outstanding color expression.

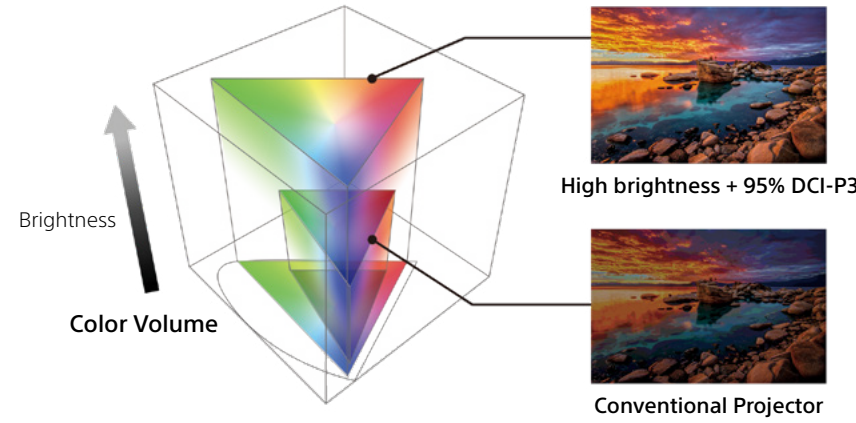

XR Clear Image

XR Clear Image analyzes individual object frame-by-frame and expresses textures close to reality down to the finest detail while minimizing noise.

*BRAVIA Projector 9 / BRAVIA Projector 8 only

Best Clarity for individual objects

Focus on the finest details. XR technology hones in on individual details, bringing unparalleled sharpness and precision to every scene.

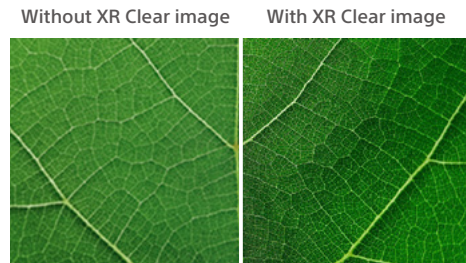

Without XR Clear image

With XR Clear image

Everything upscaled to 4K quality

See everything in crisp 4K quality. XR upscaling technology smartly recreates lost textures and details, transforming every frame to restore the director's vision.

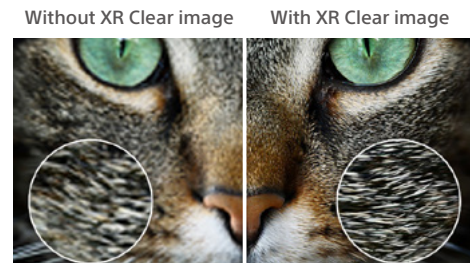

Without XR Clear image

With XR Clear image

Beautiful images without noise

Uncompromised clarity. XR's noise reduction technology ensures smooth, distraction-free visuals.

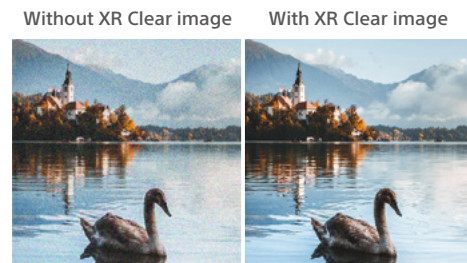

Without XR Clear image

With XR Clear image

Background technologies to achieve value

XR Processor for projector optimizes our acclaimed BRAVIA TV video processing for projection.

Cross-Analyzes

Rather than processing various elements such as color, definition, and contrast individually, it analyzes them cross-sectionally to provide more natural-looking images without artificial impressions.

*BRAVIA Projector 9 / BRAVIA Projector 8 only

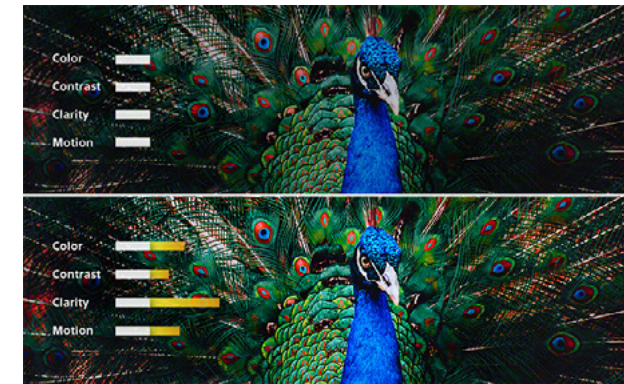

Depth Mapping

It utilizes Human Cognitive technology to enhance depth and texture for immersive experiences. Foreground depth is enhanced and the background adjusted so the entire image looks more real and natural.

*BRAVIA Projector 9 / BRAVIA Projector 8 only

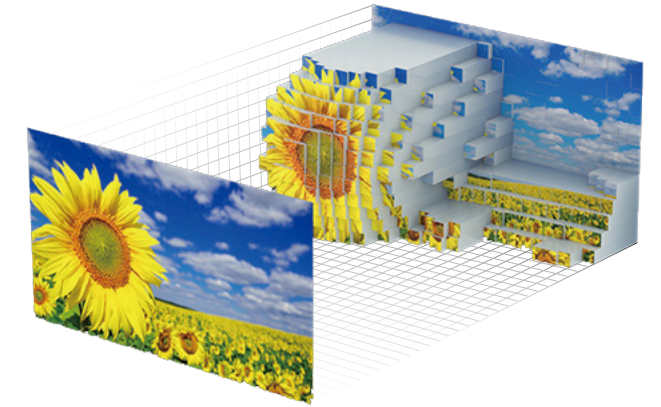

Focal Points recognition

The focal point is where you tend to focus in a picture, where your eyes are naturally drawn to within the scene. It recognizes that focal point and enhances that part of the image.

*BRAVIA Projector 9 / BRAVIA Projector 8 only





Installation Flexibility

Effortless installation.
Endless possibilities.

With effortless installation, Sony projectors open up endless possibilities. The compact, lightweight design allows for versatile setup in any space.

Compact and lightweight

Say goodbye to heavy lifting. Weighing in at 14kg, our projectors pack a punch without the bulk.



BRAVIA Projector 9 / BRAVIA Projector 8



VPL-XW5000ES

Flexible installation, consistent clarity

Effortlessly adjust your image for geometry, ensuring seamless projection at any ceiling or stand height by using with the lens shift function and corner keystone correction in combination. With XR Clear Image, content can be projected while maintaining as much clarity as possible.

*BRAVIA Projector 9 / BRAVIA Projector 8 only

Without Corner keystone correction



Projected as a trapezoid

With Corner keystone correction



Can be adjusted to shape to fit the screen

Default picture setting ideal for cinema

Stunning visuals right out of the box. Sony Home Cinema Projectors are pre-configured for cinematic color and gamma, with extensive adjustment and calibration options available if needed.

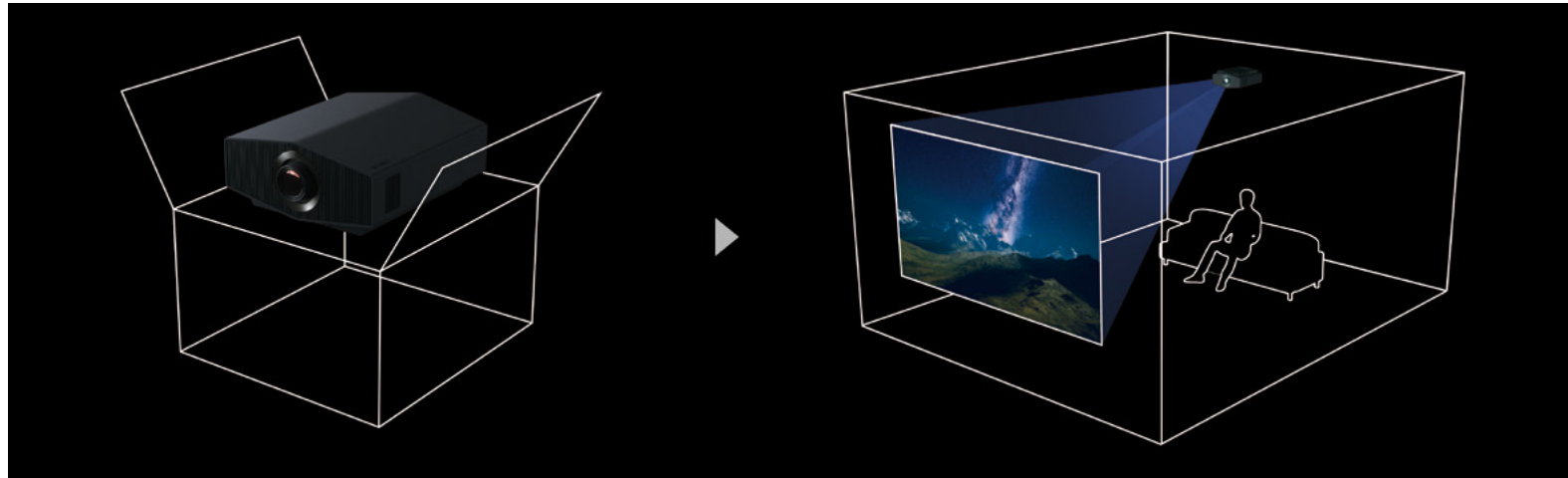

Precision controls for perfect viewing

Explore countless ways to enhance your home cinema experience with customisable settings for color correction, color space, and gamma correction to display images just the way you like them.

Color correction

Precise colour correction technology enhances the accuracy of every hue, creating lifelike images with rich tones.

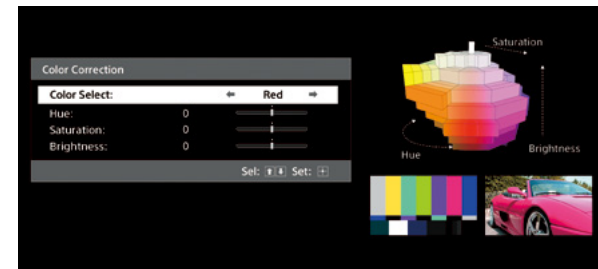

Color space

With a huge 95% DCI-P3 colour gamut, and custom colour space tuning, all your visuals are more immersive and realistic.

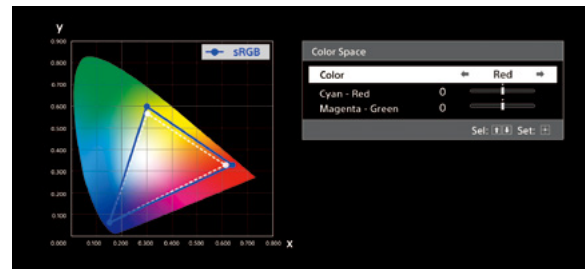

Gamma correction

It configures the response characteristics of gradation of the corrected image.

*BRAVIA Projector 9 / BRAVIA Projector 8 only

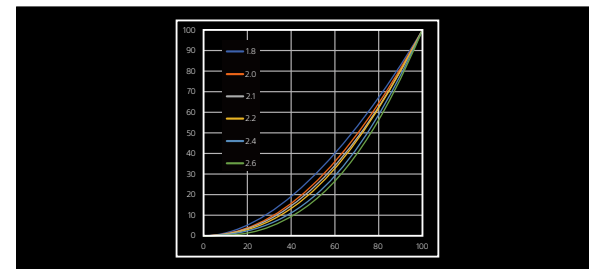

Usability

Reliability meet usability



Built for reliability and designed for usability, our projectors integrate seamlessly with industry protocols and major solutions.

Reliable operation with standard industry protocols as well as major solution partners

Home Automation Systems

One remote to manage it all. Easily integrate your projector with top home automation systems like Control4, Crestron, Savant, AMX.



Remote diagnostics

Ideal for advanced custom installations, Sony home cinema projectors support remote monitoring and diagnostics of network settings, status, and even temperature.



With 4K/120fps and ALLM (Auto Low Latency Mode) by HDMI2.1, it gives smooth and clear movement for responsive gameplay.

4K/120 fps*1

Experience lightning-fast, smooth visuals in 4K at 120 frames per second. Perfect for action-packed gaming.

*BRAVIA Projector 9 / BRAVIA Projector 8 only

4K/60 fps

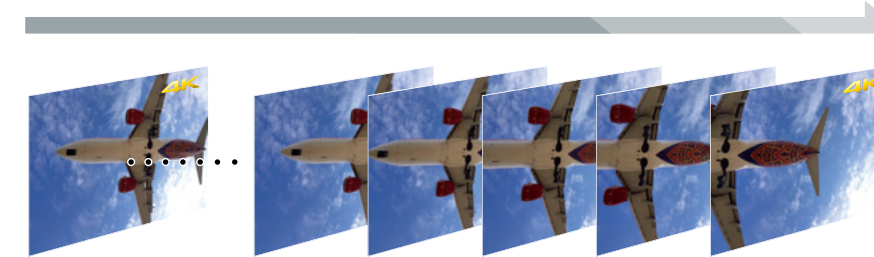

4K/120 fps

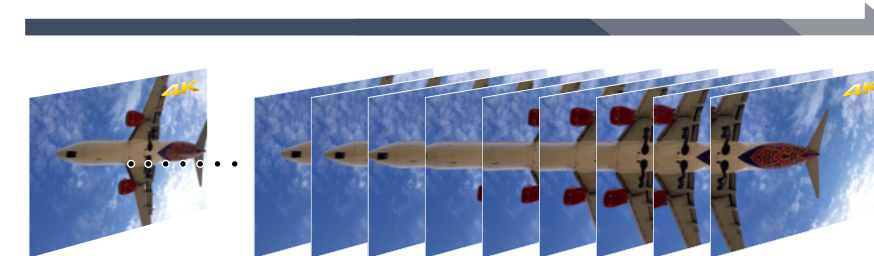

*1: 4K/120fps compatible games

Auto Low Latency Mode*2

Always game-ready. Automatically switch to game mode with Auto Low Latency Mode, ensuring responsive play and minimal lag.

*BRAVIA Projector 9 / BRAVIA Projector 8 only



Auto Low Latency Mode: OFF

Auto Low Latency Mode: ON

BRAVIA Projector 9 / BRAVIA Projector 8

Input lag reduction

21 msec for 4K/60 fps signal

12 msec for 4K/120 fps signal

*2: The Projector automatically switches Input Lag Reduction mode to on based on the ALLM information from the HDMI-connected device. In this mode, Motionflow and NR cannot be used.



Sustainability

Better tech. Better planet

Better tech helps maintain a better planet.

Our projectors are designed with sustainability in mind, featuring mercury-free components and enhanced power efficiency.

Environmentally friendly design

Better tech helps maintain a better planet. Our projectors are designed with sustainability in mind, featuring mercury-free components and enhanced power efficiency.

Power efficiency

Maximize energy efficiency without compromising on picture quality, with XR Deep Black's advanced laser control technology. Save on power, not on quality.

Mercury-free

Safer and greener. Our projectors use mercury-free laser light sources, designed to be safer for the environment and your home.

Power consumption in the dark scene

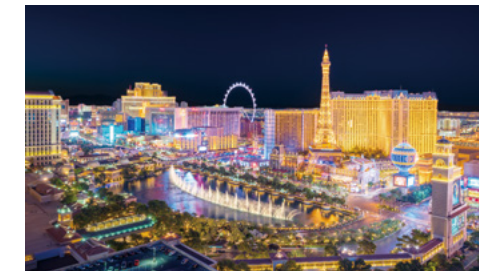

Conventional model



With XR Deep Black



Mercury usage

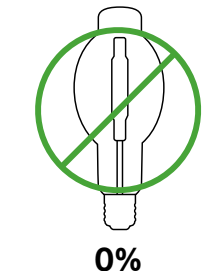

0%

All our projectors use mercury-free laser light sources.

Live Color Enhancer

The Live Color Enhancer selectively expands the color gamut, for vivid HDR images without unnatural oversaturation. Whether you're watching in daylight or a dark room, you can count on vibrant, true-to-life colors.

*BRAVIA Projector 9 only



Live Color Enhancer: **OFF**
Washout color



Live Color Enhancer: **ON**
Reproduce color

Picture Position Memory

Store focus, zoom and lens-shift settings for up to five screen formats for easy recall. Picture Position Memories store key settings so you can quickly watch movies in the ideal format. Match aspect ratios, including 16:9 and Cinemascope, and store these settings in your 4K projector.

*GTZ380 / BRAVIA Projector 9 / BRAVIA Projector 8 only

4K Motionflow

The powerful video processor in the projector offers Motionflow for smooth and clear motion, even when viewing 4K content. Motionflow is ideal for fast-moving sports content, as it adds frames to reduce blur while maintaining brightness. Cinema purists can choose True Theatre mode to retain the original 24 fps.



Motionflow: **OFF**



Motionflow: **ON**

Simulated images

Anamorphic lens compatibility for 4K signals (V-stretch for 4K)

Wide lens compatibility means you can use your legacy anamorphic lenses with ease, even with 4K content. Watch your content in your favorite formats with a full-size picture, thanks to the V-stretch function.

Make the home cinema experience bigger and better than ever

Sony 4K projectors are compatible with IMAX Enhanced content, making them ready to deliver the bigger, more breathtaking IMAX visuals you love in compatible content. Take advantage of the size of your projector screen with movies that become even more immersive with IMAX Enhanced.



IMAX
ENHANCED

Native 4K SXRD™ panel.

Immerse yourself in an incredibly lifelike picture with native 4K that offers 8.3 million pixels (3,840 x 2,160). With an 0.61-inch SXRD panel, you'll enjoy high brightness, inky blacks, vibrant colors, rich tones and textures, plus clear cinematic motion and image smoothness.

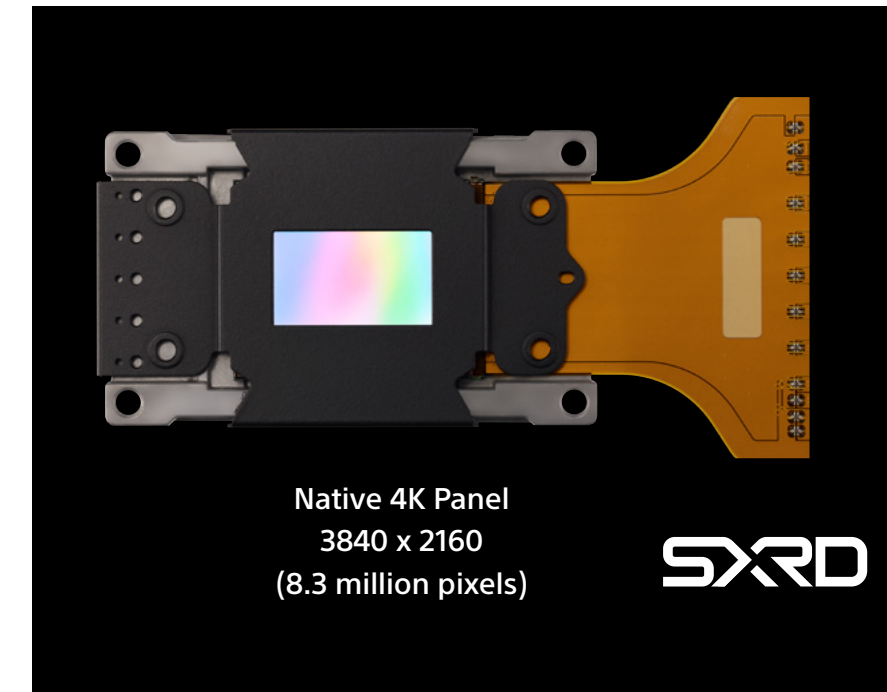

Wide Dynamic Range Optics

Our Wide Dynamic Range Optics contribute to a compact design with better light control by maximising the potential of the laser light source. The resulting higher color volume means naturally colorful images, even at high brightness levels, and stunning, immersive contrast.

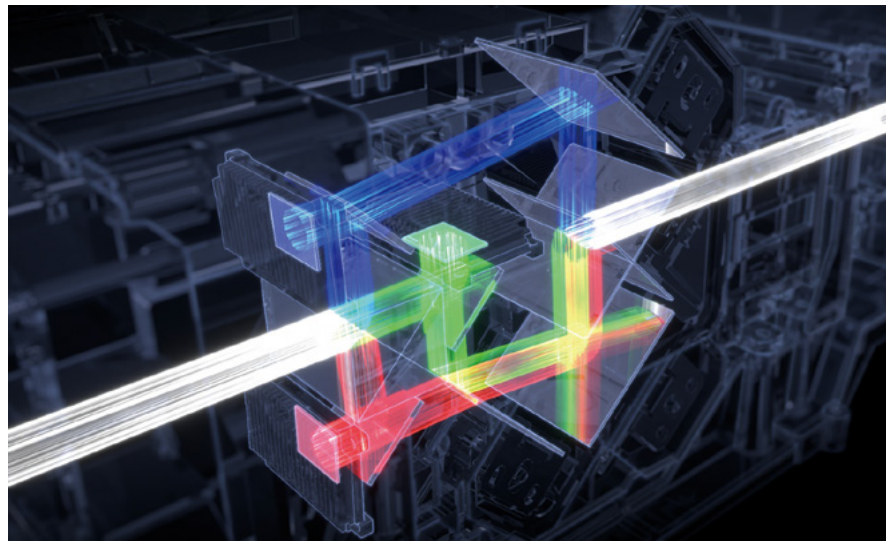

Enduring brightness from a laser light source

You'll never have to worry about changing the lamp in your home cinema projector—no lamp replacement and virtually no maintenance are required. The projector uses an ultra-pure and reliable laser light source, which lets you enjoy perfectly clear 4K pictures at optimal brightness for up to 20,000 uninterrupted hours.

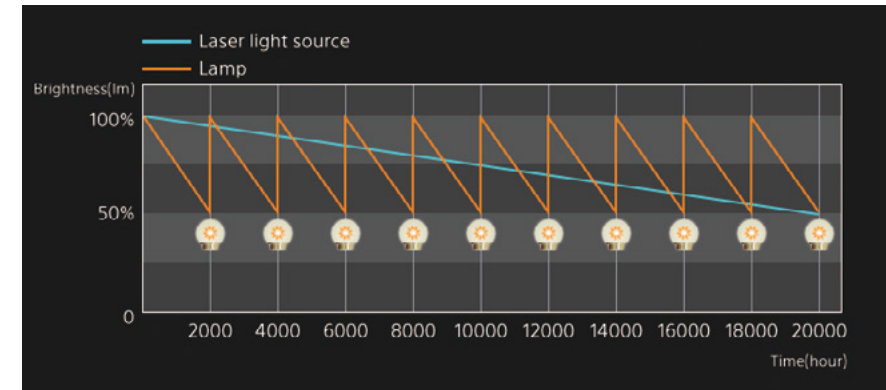

Advanced crisp focused lens

Experience flawless clarity across the entire screen, thanks to our Advanced Crisp-Focused Lens. The 70-mm aspherical front lens widens the focus area, ensuring clear images from corner to corner. A floating focus system utilises two moving lens groups and extra-low dispersion glass for distortion-free images with accurate color reproduction.

*BRAVIA Projector 9 / BRAVIA Projector 8 only

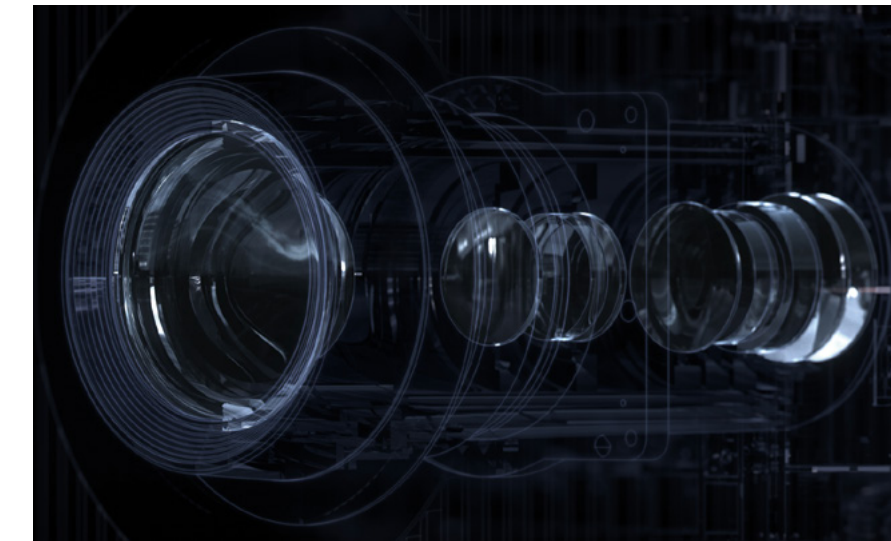

Motorized zoom lens and wide lens shift

Installing your 4K laser projector in any room is easy with a motorized zoom and a wide lens shift range. Adjust the image position vertically and horizontally for the perfect setup whatever your room size.

Advanced crisp focused lens

Experience flawless clarity across the entire screen, thanks to our Advanced Crisp-Focused Lens. The 70-mm aspherical front lens widens the focus area, ensuring clear images from corner to corner. A floating focus system utilises two moving lens groups and extra-low dispersion glass for distortion-free images with accurate color reproduction.

*BRAVIA Projector 9 / BRAVIA Projector 8 only

BRAVIA Projector 9

VPL-XW8100ES

CONNECTOR PANELS



Front

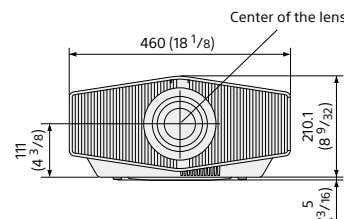

Bottom

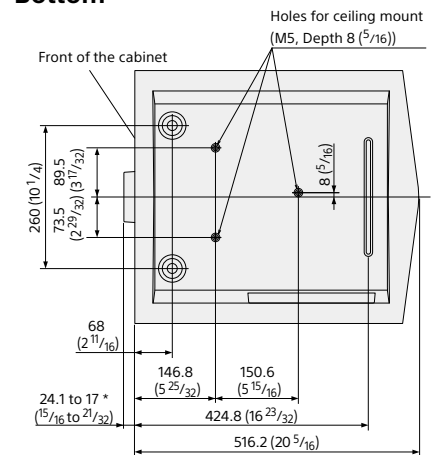

BRAVIA Projector 8

VPL-XW6100ES

CONNECTOR PANELS



Front

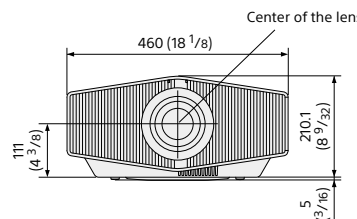

Bottom

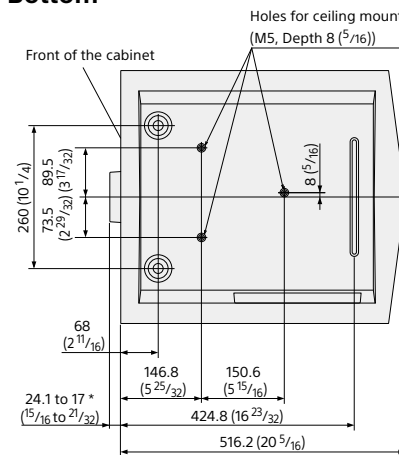

VPL-XW5000ES

CONNECTOR PANELS



Front

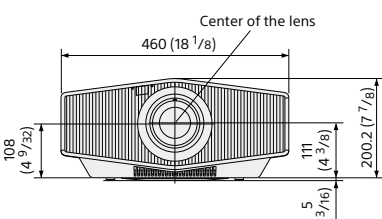

Bottom

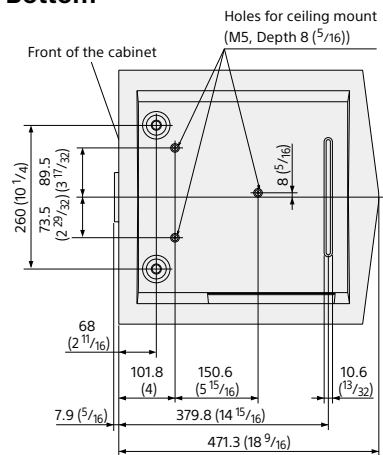

VPL-GTZ380

CONNECTOR PANELS

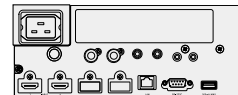

Front

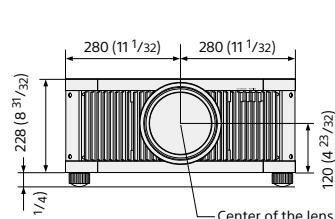

Bottom

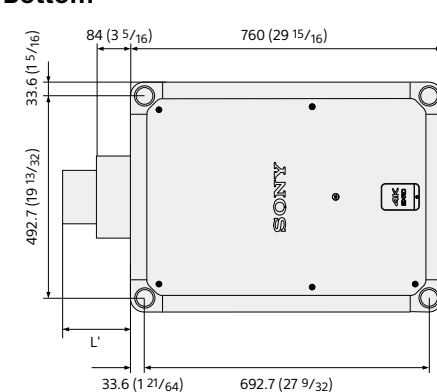

Unit : mm (inches)

*VPL-GTZ380
VPLL-Z8014 (Optional) : L'= 173 (6 13/16)
VPLL-Z8008 (Optional) : L'= Wide 184 (7 1/4) / Tele 175 (6 7/8)

*BRAVIA Projector 9 / BRAVIA Projector 8 only
Varies depending on how focus is adjusted.

	BRAVIA Projector 9 VPL-XW8100ES	BRAVIA Projector 8 VPL-XW6100ES	VPL-XW5000ES	VPL-GTZ380
Display system	4K SXRD panel, projection system	4K SXRD panel, projection system	4K SXRD panel, projection system	4K SXRD panel, projection system
Display device	Size of effective display area Number of pixels	0.61" x 3 24,883,200 (3840 x 2160 x 3) pixels	0.61" x 3 24,883,200 (3840 x 2160 x 3) pixels	0.74" x 3 26,542,080 (4096 x 2160 x 3) pixels
Light output	3,400 lm Light source	3,400 lm Laser diode	2,700 lm Laser diode	10,000 lm Laser diode
Dynamic contrast	∞ : 1	∞ : 1	∞ : 1	∞ : 1
Projection lens	Focus Zoom Lens shift	Powered Powered (Approx. x 2.1) Powered, Vertical +/- 85 %, Horizontal +/- 36 %	Powered Powered (Approx. x 2.1) Powered, Vertical +/- 85 %, Horizontal +/- 36 %	Manual Manual (Approx. x 1.60) Manual, Vertical +/- 71 %, Horizontal +/- 25 %
	Throw ratio*1	1.35:1 to 2.84:1	1.35:1 to 2.84:1	1.38:1 to 2.21:1
	Picture position memory	3	3	5
Picture processor	XR Processor for projector Contrast Color Clarity Motion	XR Processor for projector XR Dynamic Tone Mapping XR Deep Black XR Triluminos Pro Live Color Enhancer XR Clear Image	XR Processor for projector XR Dynamic Tone Mapping XR Deep Black Triluminos Pro XR Clear Image	X1 Ultimate for projector Object-based HDR remaster Dynamic HDR Enhancer Triluminos Pro Object-based Super Resolution Dual Database Processing Digital Focus Optimizer Motionflow
Accepted HDR format	HDR10/HLG	HDR10/HLG	HDR10/HLG	HDR10/HLG
Accepted digital signals	720x576/50p, 720x480/60p, 1280x720/50p, 1280x720/60p, 1920x1080/50i, 1920x1080/60i, 1920x1080/24p, 1920x1080/48p, 1920x1080/50p, 1920x1080/60p, 1920x1080/100p, 1920x1080/120p, 3840x2160/24p, 3840x2160/25p, 3840x2160/30p, 3840x2160/48p, 3840x2160/50p, 3840x2160/60p, 3840x2160/100p, 3840x2160/120p, 4096x2160/24p, 4096x2160/25p, 4096x2160/30p, 4096x2160/48p, 4096x2160/50p, 4096x2160/60p, 4096x2160/100p, 4096x2160/120p	720x576/50p, 720x480/60p, 1280x720/50p, 1280x720/60p, 1920x1080/50i, 1920x1080/60i, 1920x1080/24p, 1920x1080/48p, 1920x1080/50p, 1920x1080/60p, 1920x1080/100p, 1920x1080/120p, 3840x2160/24p, 3840x2160/25p, 3840x2160/30p, 3840x2160/48p, 3840x2160/50p, 3840x2160/60p, 3840x2160/100p, 3840x2160/120p, 4096x2160/24p, 4096x2160/25p, 4096x2160/30p, 4096x2160/48p, 4096x2160/50p, 4096x2160/60p, 4096x2160/100p, 4096x2160/120p	720 x 576/50p, 720 x 480/60p, 1280 x 720/50p, 1280 x 720/60p, 1920 x 1080/50i, 1920 x 1080/60i, 1920 x 1080/24p, 1920 x 1080/50p, 1920 x 1080/60p, 1920 x 1080/120p, 1920 x 1080/100p, 3840 x 2160/24p, 3840 x 2160/25p, 3840 x 2160/30p, 3840 x 2160/48p, 3840 x 2160/50p, 3840 x 2160/60p, 4096 x 2160/24p, 4096 x 2160/25p, 4096 x 2160/30p, 4096 x 2160/48p, 4096 x 2160/50p, 4096 x 2160/60p	720 x 576/50p, 720 x 480/60p, 1280 x 720/50p, 1280 x 720/60p, 1920 x 1080/50i, 1920 x 1080/60i, 1920 x 1080/24p, 1920 x 1080/50p, 1920 x 1080/60p, 1920 x 1080/100p, 3840 x 2160/24p, 3840 x 2160/25p, 3840 x 2160/30p, 3840 x 2160/48p, 3840 x 2160/50p, 3840 x 2160/60p, 4096 x 2160/24p, 4096 x 2160/25p, 4096 x 2160/30p, 4096 x 2160/48p, 4096 x 2160/50p, 4096 x 2160/60p, WUXGA/60p, QXGA/60p, QXGA/120p, WQHD/60p, WQHD/120p, WQXGA/60p, WQXGA/120p
3D	-	-	-	Yes
Input Output (Computer / Video / Control)	HDMI Display Port Trigger RS-232C LAN IR IN / OUT 3D SYNC OUT USB (for Firmware update)	x 2 (HDMI2.1/HDCP2.3) - x 1 (Mini jack, DC 12 V, Max. 100 mA) x 1 (D-sub 9-pin (male)) x 1 (RJ-45, 10BASE-T/100BASE-TX) IN: x 1 (Mini jack) - x 1 (Type A, DC 5 V, Max. 500 mA)	x 2 (HDMI2.0/HDCP2.3) - x 1 (Mini jack, DC 12 V, Max. 100 mA) x 1 (D-sub 9-pin (male)) x 1 (RJ-45, 10BASE-T/100BASE-TX) IN: x 1 (Mini jack) - x 1 (Type A, DC 5 V, Max. 500 mA)	x 2 (HDMI2.0/HDCP2.3) x 2 (HDCP2.3) x 2 (Mini jack, DC 12 V, Max. 100 mA) x 1 (D-sub 9-pin (male)) x 1 (RJ-45, 10BASE-T/100BASE-TX) IN: x 1 (Mini jack) x 1 (3-pin mini-DIN (VESA 3D)) x 1 (Type A, DC 5 V, Max. 500 mA)
Acoustic noise*2	26 dB	26 dB	24 dB	33-39 dB
Power requirements	AC 100-240 V, 50/60 Hz	AC 100-240 V, 50/60 Hz	AC 100-240 V, 50/60 Hz	AC 200-240 V, 50/60 Hz AC 100-120 V, 50/60 Hz (Brightness is dimmed.) Max. 2.0 kW (TBD)
Power consumption	420 W Standby Networked Standby	380 W 0.3 W (when "Remote Start" is set to "Off") 0.5 W (LAN) (when "Remote Start" is set to "On") When a LAN terminal is not connected, it becomes a low power consumption mode (0.4 W)	295 W 0.3 W (when "Remote Start" is set to "Off") 0.5 W (LAN) (when "Remote Start" is set to "On") When a LAN terminal is not connected, it becomes a low power consumption mode (0.4 W)	0.4 W (when "Remote Start" is set to "Off") 1.0 W (LAN) (when "Remote Start" is set to "On")
Dimensions (Without Protrusions)	W 460 x H 210 x D 517 mm (W 18 1/8 x H 8 9/32 x D 20 11/32 in)	W 460 x H 210 x D 517 mm (W 18 1/8 x H 8 9/32 x D 20 11/32 in)	W 460 x H 200 x D 472 mm (W 18 1/8 x H 7 7/8 x D 18 19/32 in)	W 560 x H 228 x D 760 mm (W 22 1/16 x H 8 31/32 x D 29 15/16 in)
Mass	Approx. 14 kg / 31 lb	Approx. 14 kg / 31 lb	Approx. 13 kg / 28 lb	Approx. 51 kg / 112 lb.
Supplied accessories	Remote Control (RM-PJ24), Size AA (R6/LR6) batteries (2), AC Power Cord (1), Lens Cap (1), Setup Guide (1)	Remote Control (RM-PJ24), Size AA (R6/LR6) batteries (2), AC Power Cord (1), Lens Cap (1), Setup Guide (1)	Remote Control (RM-PJ28), Size AA (R6/LR6) batteries (2), AC Power Cord (1), Lens Cap (1), Setup Guide (1)	RM-PJ29 Remote Commander (1), Size AA (R6/LR6) batteries (2), AC power Cord (1), Lens Cap (1), Plug holder (1), Safety Regulations (1)
Optional accessories	-	-	-	VPLL-Z8014 (Normal throw lens) VPLL-Z8008 (Short throw lens)

*1 Display size : 16:9
*2 Depends on the projector setting condition and usage environment.

You've got our support

PrimeSupport

PrimeSupport is our comprehensive aftersales service dedicated to European business customers of Sony Professional products.

All our products come with 3 years PrimeSupport as standard, with an option to extend that service up to 5 years in total.

Our 3 Year After-sales service package comes as standard



EU wide professional "ELITE" Helpdesk available Mon-Fri 9am-6pm



3 years as standard. +1 or 2 years PrimeSupport Elite extensions available including a loan unit during repair. (Up to 4 years or 9,600 hours | Up to 5 years or 12,000 hours)



Faulty projectors are recycled as part of our Road to Zero initiative

Even greater peace of mind

Expanded after-sales care options for BRAVIA Home Projectors



PrimeSupport Pro

Find your local telephone number to contact our PrimeSupport Helpdesk on our website pro.sony/support-services/support-contact-us Monday to Friday 09:00 - 18:00 (Central European Time), excluding local national holidays. Support is available in English, French, Italian, German and Spanish.

Optional PrimeSupport Pro packs can be purchased to add a 2-year extension to the standard 3-year PrimeSupport, and to give long-term assurance of expert support and technical assistance for a total of 5 years from the purchase date.

For full information and pricing details, please get in touch with your Sony team or email primesupport@sony.com

SONY

Distributed by

©2024 Sony Corporation. All rights reserved.

Reproduction in whole or in part without written permission is prohibited.

Features, design, and specifications are subject to change without notice.

The values for mass and dimension are approximate.

Some images in this brochure are simulated.

"SONY" is a registered trademark of Sony Corporation.

"Z-Phosphor", "TRILUMINOS" and "Remote Commander" are trademarks of Sony Corporation.

SXRD is a registered trademark or a trademark of Sony Group Corporation or its affiliates.

IMAX® is a registered trademark of IMAX Corporation in the United States and/or other countries.

All Rights Reserved.

The terms HDMI and HDMI High-Definition Multimedia Interface, and the HDMI Logo are trademarks or registered trademarks of HDMI Licensing LLC in the United States and other countries.

All other trademarks are the property of their respective owners.

Please visit Sony's professional website or contact your Sony representative for specific models available in your region.

MK2024YIT24SEP01