

D40

USER MANUAL

MAJORITY

HOME AUDIO • CAMBRIDGE

Contents	2
Box Contents	3
Controls & Functions	4
Setting up your Majority D40 Speakers	7
Basic Operation	8
Bluetooth, SD & USB Controls.....	9
AUX and Optical Modes.....	10
Bluetooth Mode	11
USB & SD Card Mode.....	12
Connecting Headphones	13
Troubleshooting	14
Spec & Warranty	15
Safety Information.....	16

3 YEAR
WARRANTY
TV

Register your product online for a FREE 3 year extended warranty at: www.majority.co.uk

WHAT'S IN THE BOX

- A. Majority D40 Bookshelf Speakers
- B. 3.5mm to 3.5mm AUX Cable
- C. 3.5mm to RCA Cable
- D. Instructions Guide
- E. Remote Control
- F. Power Adapter

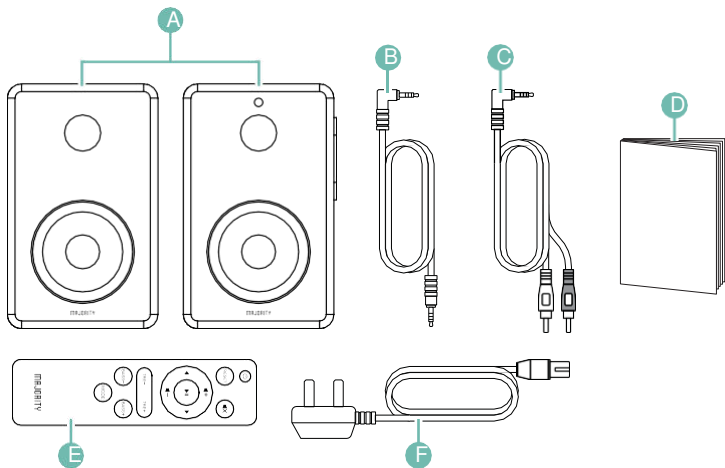

FRONT VIEW

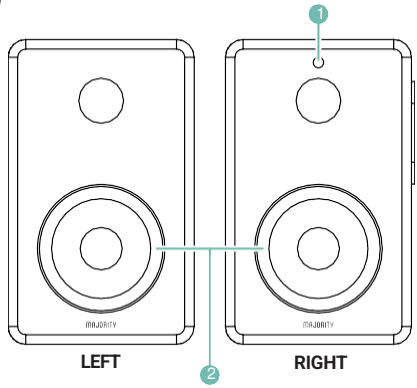

1. Remote Sensor

2. Speakers

SIDE VIEW

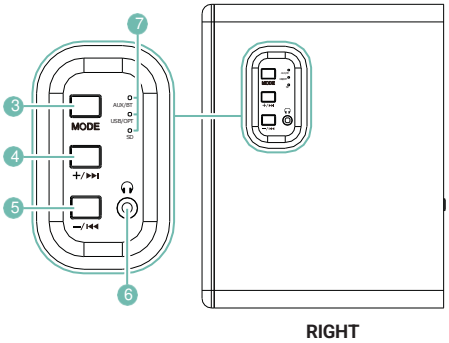

3. Mode

4. Vol + / Next

5. Vol - / Previous

4

6. Headphone Jack

7. Mode indicator lights

RIGHT

BACK VIEW

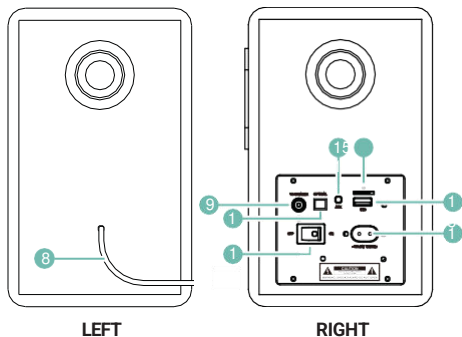

8. Speaker connector cable

9. Output to left speaker

10. OPTICAL input

11. Power On/Off

12. 100~240V/50-60HZ Power

13. USB slot

14. SD Card slot

15. AUX input

REMOTE CONTROL

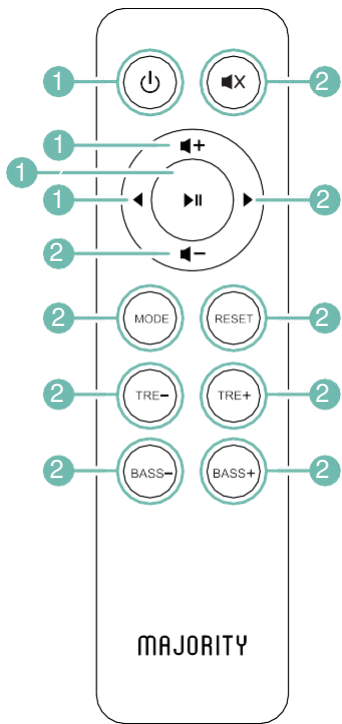

- 16. Power
- 17. Reset
- 18. Vol +
- 19. Play/Pause
- 20. Previous/Back
- 21. Vol -
- 22. Treble -
- 23. Bass -
- 24. Mode
- 25. Bass +
- 26. Treble +
- 27. Next
- 28. Mute



Please note that the instructions in this manual will refer to the speaker or remote control button number e.g (Ref.*number*) in accordance with the diagrams on pages 2-4.

Connecting and powering the unit

Using the power cord provided, plug one end into the back of the primary speaker (**Ref.12**) and plug the other end into a mains socket. Switch the unit on at the back of the primary speaker (**Ref.11**).

Connect the two speakers together via the speaker connector cable (**Ref.8**). To do this, plug the left speaker connector cable plug into the right (primary) speaker connector, which reads ('To L speaker') (**Ref.9**).

Switch on your Majority D40 Speakers

Press the  button (**Ref.16**) or press and hold the 'Mode' button on the unit (**Ref.3**) to switch on the speakers. Press the  button (**Ref.16**) to switch the speakers off.



Remote Power

Remove the battery cover of the remote control. Insert 2 x AAA batteries (included).
Replace battery cover.





Note: when using the remote control, ensure that you are pointing at the remote sensor (**Ref.1**) otherwise the unit may not respond to keypresses.

Basic controls

Volume, treble and bass can be changed on all speaker modes.

Use the  + (Ref.18)/(Ref.4) and  - (Ref.21)/(Ref.5) buttons to control the volume. Press  X (Ref.28) to mute the audio.

Use the Treble- (Ref.22), Treble+ (Ref.26), Bass- (Ref.23) and Bass+ (Ref.25) to control the bass and treble settings of the sound. Press 'RESET' (Ref.17) to reset the treble and bass settings.

In Bluetooth, SD, or USB mode, use the   (Ref.20)/(Ref.27) and  +/  buttons (press and hold (Ref.4)/(Ref.5)) to skip tracks and rewind or fast forward (see page 7).

Switching mode

When a USB, SD card or AUX cable is inserted, the unit will automatically switch to the correct mode and begin playing audio. If necessary, select the correct mode using the 'Mode' button (Ref.24)/(Ref.3).

On the speaker set, Bluetooth and USB modes are indicated by a blue light. All other modes are indicated by a red light (Ref.7).

Please note that the following controls and functions relate to Bluetooth, SD card and USB mode only. For AUX and Optical controls and functions, please see the section 'AUX and Optical Modes' (page 8).

Note: in the table below, (H) = 'Press and hold'.

Remote	Speaker	Function
- +	-/⏮ +/⏭	Volume up/down
⏮ ⏭	(H) -/⏮ +/⏭	Previous/next track
(H)⏮ ⏭	n/a	Rewind/Fast forward
X	n/a	Mute
⏸	MODE	Play/Pause
TRE-/TRE+	n/a	Treble up/down
BASS-/BASS+	n/a	Bass up/down
MODE	(H) MODE	Change Mode
RESET	n/a	Reset Treble/Bass

Use the 3.5mm to 3.5mm AUX cable or 3.5mm to RCA cable to connect an external AUX device to the 'AUX' input of the D40 speakers (**Ref.15**).

Switch to AUX mode

When an AUX cable is plugged in to the AUX port at the rear of the speaker (**Ref.15**), the unit will automatically switch to AUX mode (indicated with a red light (**Ref.7**)) and you will hear the words 'Line in' from the speakers. If necessary, select 'AUX' mode using the 'Mode' button (**Ref.24**)/(**Ref.3**).





Optical mode

To connect the D40 speakers to an external device, use an optical cable to connect via the OPTICAL input (**Ref.10**).

Press the 'Mode' button (**Ref.24**)/(**Ref.3**) to switch the Mode to Optical. The corresponding mode indicator light (**Ref.7**) will light up red and you will hear the word 'Optical' from the speakers when Optical mode is selected.

Controls and Functions - AUX/Optical

Note: in the table below, (H) = 'Press and hold'.

Remote	Speaker	Function
 - 	-/⏮ +/⏭	Volume up/down
 X 	MODE	Mute
TRE-/TRE+	n/a	Treble up/down
BASS-/BASS+	n/a	Bass up/down
MODE	(H) MODE	Change Mode
RESET	n/a	Reset Treble/Bass

To connect an external device to the D40 speakers, ensure that the speakers are in 'Bluetooth' mode. Select 'Bluetooth' mode manually by using the 'Mode' button **(Ref.24)/(Ref.3)** until the corresponding mode indicator light, labelled 'AUX/BT', **(Ref.7)** lights up blue. You will hear the word 'Bluetooth' to indicate that Bluetooth mode is now active.

Switch Bluetooth on for your external device. Select 'D40' from the list of devices. When your external device is connected, you will hear the words 'Bluetooth Connected' to indicate successful connection. You can now play audio through the speakers. When Bluetooth is disconnected, you will hear the words 'Bluetooth Disconnected' to indicate successful disconnection.

Controls and Functions

Please see page 7.

USB

To use USB mode, insert a USB drive into the USB port at the back of the speaker (Ref.13). You will hear the word 'USB' from the speakers indicating that USB mode is active, and the 'USB/OPT' mode indicator light (Ref.7) will light up blue. If necessary, select 'USB' mode using the 'Mode' button (Ref.24)/(Ref.3).

SD

To use SD mode, insert a SD/TF card into the SD port at the back of the speaker (Ref.14). You will hear the words 'Memory card' come from the speakers, indicating that SD card mode is active, and the 'SD' mode indicator light (Ref.7) will light up red. If necessary, select 'SD' mode using the 'Mode' button (Ref.24)/(Ref.3).

Maximum storage compatibility for USB and SD/TF cards: 64GB.

Controls and Functions

Please see page 7.

Connect wired headphones (not included) to the headphone port of the Majority D40 speakers (**Ref.6**) to listen to audio through headphones.

Ensure the volume is turned down before you use the headphones.

You will now hear audio output through the headphones.

Please note that the Majority D40 speakers are not compatible with Bluetooth headphones.

Observation	Potential Cause/Solution
No power/function	Check whether the power is switched on or off at the wall. Check that the power adaptor is properly connected to the power outlet.
No sound	Check whether unit is set to MUTE. Check whether MODE is correctly selected. Turn up the volume on the speakers or on your external device. Check that cables are properly installed.
Function disturbance	Switch off and unplug the unit. Leave it for 2 minutes and switch it on again.
Bluetooth not connecting	Ensure that you are on Bluetooth mode on the speaker and the Bluetooth on your device is switched on. Select the Bluetooth device 'D40' and you should now be able to play audio.

SUPPORT

If you require further assistance with your new soundbar, please contact our support team on the Majority website: www.majority.co.uk/support

SPECIFICATION

Power Supply	100-240V/50-60Hz
Mode:	Bluetooth 3.5mm AUX-in USB reader SD reader
Power consumption	0.5W (standby mode)
Dimensions	223 x 137 x 179 mm
Weight	3.80 kg
Speakers	2*4" full range + 2 * 1" tweeter
Bluetooth Version	5.0
Bluetooth range	up to 10 meters
Compatible file types	MP3, WMA, FLAC, MAV, APE
Maximum compatible USB/SD storage	64GB

WARRANTY

All products come with a standard 12 month warranty. All items must be registered on www.majority.co.uk for the warranty to be valid. Once on the web page, use the menu to find "Register Your Product". You will also be given the chance to extend your warranty for an additional 24 months, free of charge.

1. Read these instructions.
2. Keep these instructions. Instructions are also available for download at www.majority.co.uk
3. Heed all Warnings
4. Follow all instructions
5. Do not clean the apparatus near or with water
6. Do not block any ventilation openings. Install in accordance with the manufacturer's instructions
7. Do not install near any heat sources such as radiators, heat registers, stoves, or other apparatus (including amplifiers) that produce heat.
8. Protect the power from being walked on or pinched particularly at plugs, convenience receptacles, and the point where they exit from the apparatus.
9. Only use attachments/accessories specified by the manufacturer.
10. Unplug this apparatus during light storms or when unused for long periods of time.
11. Refer all servicing to qualified service personnel.
Servicing is required when the apparatus has been damaged in a way, such as power-supply cord or plug is damaged, liquid has been spilled or objects have fallen into the apparatus, the apparatus has been exposed to the rain or moisture, does not operate normally or has been dropped.
12. No naked flame sources, such as lit candles, should be placed on the apparatus.
13. Dispose of used electrical products and batteries safely according to your local authority and regulations.

ADDITIONAL WARNINGS

The apparatus shall not be exposed to dripping or splashing and no objects filled with liquid, such as vases, shall be placed on the apparatus.

Main plug is used to disconnect device and it should remain readily operable during intended use. In order to disconnect the apparatus from the main mains completely, the mains plug should be disconnected from the main socket outlet completely.

Battery shall not be exposed to excessive heat such as sunshine, fire or the like.

RECYCLING ELECTRICAL PRODUCTS



You should now recycle your waste electrical goods and in doing so help the environment.

This symbol means an electrical product should not be disposed of with normal household waste.

Please ensure it is taken to a suitable facility for disposal when finished with.

IMPORTANT: Please read all instructions carefully before use and keep for future reference.



Risk of electric shock.
Do not open



Read all instructions carefully before use and keep for future reference



When servicing, use only identical replacement parts



CAUTION

RISK OF ELECTRIC SHOCK
DO NOT OPEN



ATTENTION

RISQUE D'ELECTROCUTION
NE PAS OUVRIR



IMPORTANT: Please read all instructions carefully before use and keep for future reference



MAJORITY

WWW.MAJORITY.CO.UK