

Majority Everest

5.1 Dolby Audio Surround Sound System



Instructions Guide

Contents

What's In The Box?	1
Controls And Functions	2-10
Support	11
Connecting to the Everest soundbar	12
Instructions Guide	13-19
Using the AUX IN Cable	13
Using the HDMI (ARC) Input	14
Using the Optical Input	15
Using the MP3 Link Connection (Line In)	16
Connecting to the Mains Supply	17
Using the Bluetooth Operation	18
Using the USB Operation	19
Troubleshooting	20
Specifications	21
Wall Mount Installation Guide	22-23
Quick System Installation Guide	24
Safety Information	25

What's In The Box?

Box Contents

1. Majority Everest Soundbar
2. Remote Control
3. Power Adapter x4
4. AUX IN Cable
5. 3.5mm to 3.5mm Line In Cable
6. User Manual
7. Surround
8. Subwoofer
9. Aluminium Pedestal
10. Side cover accessories
11. Wall mount adaptor



1. Majority Everest Soundbar



2. Remote Control



3. Power Adapter



4. AUX IN Cable



5. 3.5mm to 3.5mm Line In Cable



6. User Manual

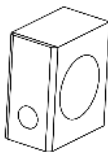

7. Surround x2 8. Subwoofer x 1 9. Aluminium Pedestal 10. Side cover accessories 11. Wall mount adaptor

Side View/Control Buttons

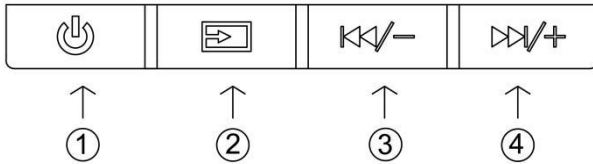

1. Power On/Off
2. Source

3. Volume-/Previous
4. Volume+/Next

Back View

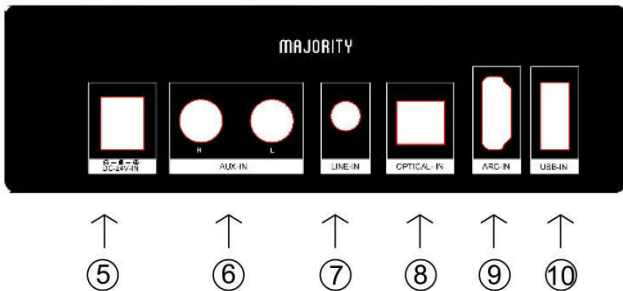

5. DC Power Input
6. AUX-In Input
7. Line-In Input

8. Optical Input
9. ARC Input
- 10.USB Input

Controls And Functions

Remote Control

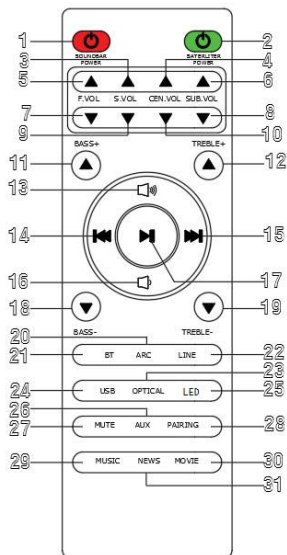

Remote Control

- 1. Soundbar Power On/Off**
Short press the button to turn on/off
- 2. Saterliter Power On/Off**
Short press the button to turn on
Long press the button to turn on
- 3. S.VOL (Volume + for Wireless Surround)**
Press to increase the volume for wireless surrounds
- 4. CEN.VOL (Volume + for Center Tone)**
Press to increase the volume for center tone
- 5. F.VOL (Volume + for Front Tone)**
Press to increase the volume for front tone
- 6. SUB.VOL (Volume + for Subwoofer)**
Press to increase the volume for subwoofer
- 7. F.VOL (Volume - for Front Tone)**
Press to decrease the volume for front tone
- 8. SUB.VOL (Volume - for Subwoofer)** Press
to decrease the volume for subwoofer
- 9. S.VOL (Volume - for Wireless Surround)**
Press to decrease the volume for wireless surrounds
- 10. CEN.VOL (Volume - for Center Tone)**
Press to decrease the volume for center tone

Remote Control

11. **Bass Increase**
Press to increase the bass
12. **Treble Increase**
Press to increase the treble
13. **Master.VOL (Master Volume+ for the Whole Kit)**
Press to increase the volume for the whole kit
14. **Back Step (Previous)**
Use in AUX In, Line In or Bluetooth mode to go back a track
15. **Forward Step (Next)**
Use in AUX In, Line In or Bluetooth mode to go forward a track
16. **Master.VOL (Master Volume- for the Whole Kit)**
Press to decrease the volume for the whole kit
17. **Play / Pause**
Press to play and pause
18. **Bass Decrease**
Press to decrease the bass
19. **Treble Decrease**
Press to decrease the treble
20. **HDMI (ARC) Mode**
Press the button to enter HDMI (ARC) mode
21. **Bluetooth Mode**
Press the button to enter Bluetooth mode

Remote Control

22. **Line In Mode**
Press the button to enter Line In mode
23. **Optical Mode**
Press the button to enter optical mode
24. **USB Mode**
Press the button to enter USB mode
25. **LED Mode**
Press the button to enter power off screen
26. **AUX In Mode**
Press the button to enter AUX In mode
27. **Mute Mode**
Press the button to enter mute mode
28. **Pairing Mode**
Press the button to enter pairing bluetooth
29. **Music Mode**
Press the button to enter music mode
30. **Movie Mode**
Press the button to enter movie mode
31. **News Mode**
Press the button to enter news mode

Controls And Functions

Using the Remote Control

The remote control sensor at the front of the soundbar is sensitive to the remote control's commands up to a maximum of 8 metres away and within a maximum arc of 30 degrees.

Please note that the operating distance may vary depending on the brightness of the room.

Automatic Display Dimmer - after 20s if no button is pressed the display is dimmed to off. Press any button on soundbar or remote control to reactivate the display.

Soundbar Wall Mount Dimensions

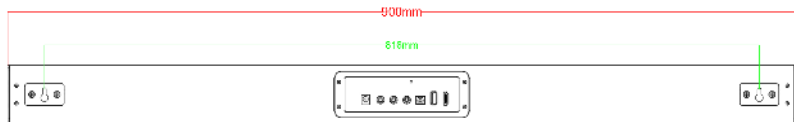

Subwoofer

5.25 Inch Wireless Subwoofer

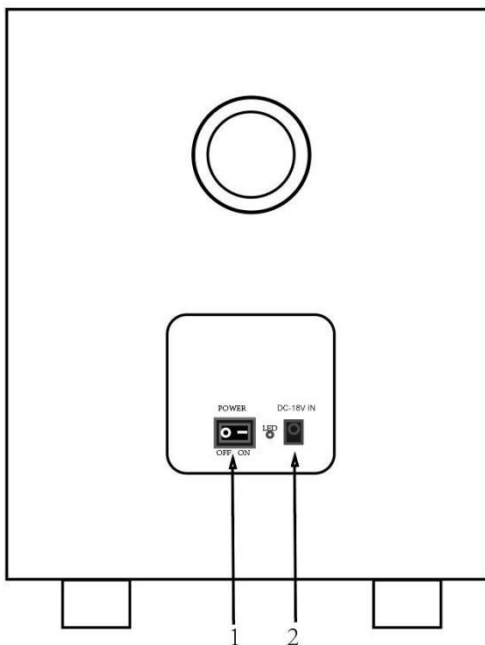

1. Power Switch
2. DC Adapter Input

Controls And Functions

Wireless Surround Speaker

2 pieces Wireless Surround Speaker

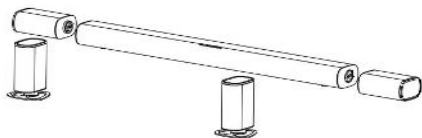

Detachable Surround Speaker from main Soundbar to be Standing Speaker, power supported by DC 3.7V / 3600mA built-in battery. Power of Surround Speaker is supporting charged by main soundbar directly, it can also be charged with a DC 5V power supply after disassembly. The battery has an overcharge protection function.

When connecting the surround speakers to the main soundbar, please pay attention to distinguish the left and right surround speaker. Please make sure the left surround speaker is connected to the left side of the main soundbar, and the right surround speaker is connected to the right side of the main soundbar.

Controls And Functions

Wireless Surround Speaker

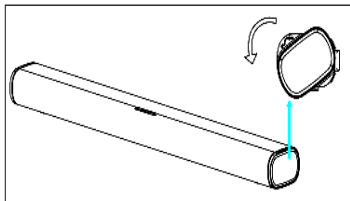

Remove the left and right cover by rotating in the direction of the arrow.

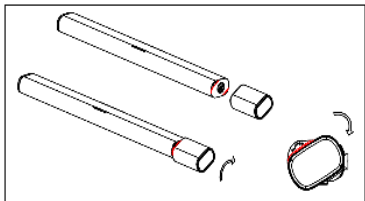

Install left and right surround speakers : Set the angle between the incline of the surround and the grain on the side cover (red), rotate according to the arrow, then install the speaker.

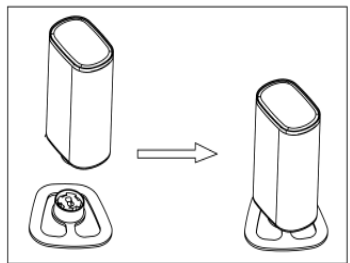

Install the metal base of the surround speaker removed from the main soundbar at the angle shown in the picture.

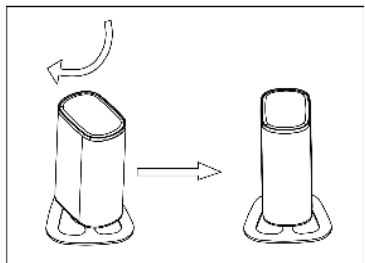

Keep the metal base stationary and turn the surround speaker clockwise (as shown in the figure) to install the surround speaker

Support

Thank you for your purchasing the Majority Everest Soundbar.

Please follow the guidance of the user manual to set up your new purchase and begin enjoying its features.

For further technical support and warranty registration, please visit our website www.majority.co.uk

Connecting to the Everest soundbar

Connecting to the Everest soundbar

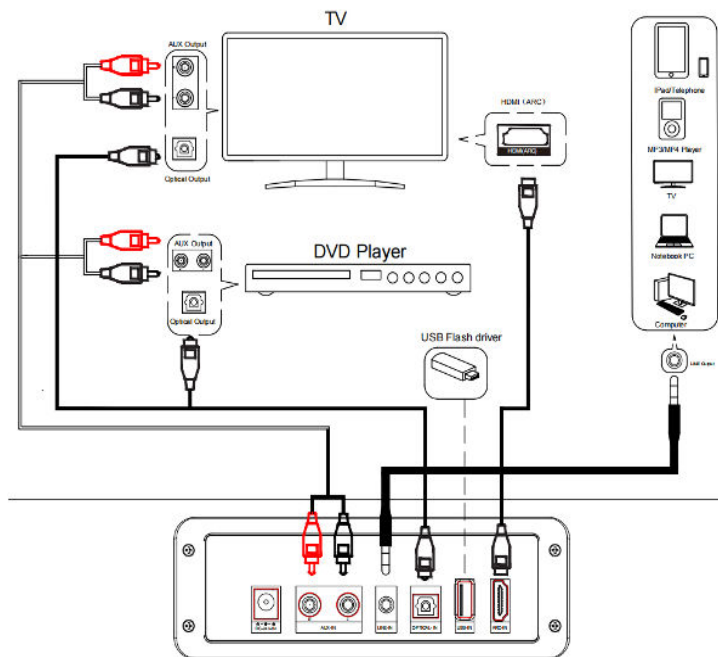

Using the AUX IN Cable

Use the AUX Stereo Audio Cable (included) to connect the TV's stereo AUX (L/R) audio output socket.

Connect the audio output cable of the soundbar via the 'AUX' input sockets of the unit.

Press the POWER button on the soundbar or POWER button directly on the remote control (**Rem.1**) to switch on the unit.

Then press MODE on the remote control (**Rem.26**) or press the Mode button on the unit to scroll to the AUX IN function.

Turn on your television

Troubleshooting: If you are not receiving a picture or encountering interference, please ensure that the AUX cable is being connected to 'output' AUX port on your TV set. This will ensure that the sound is being exported correctly.

If your TV does not have 'output' AUX port, please use an alternative connection method.

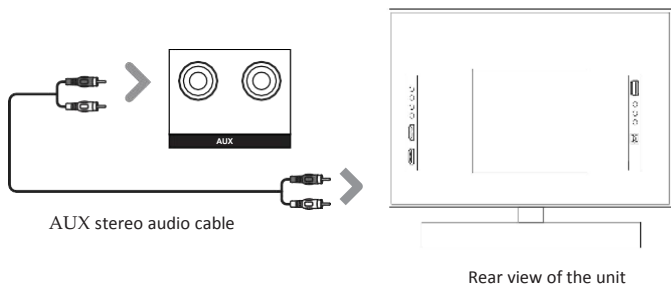

Instructions Guide

Using the HDMI ARC Input

You will need: An audio source with an ARC Audio Output and a ARC Audio cable (not included).

Connect the ARC Audio cable to the ARC output on the audio source and to the ARC Input on the soundbar.

Press the POWER button on the soundbar or POWER button directly on the remote control (**Rem.1**) to switch on the unit.

Long press (2-3 seconds) the MODE button on the remote control (**Rem.20**) to switch to ARC mode or select the Mode button on main unit repeatedly to select the ARC mode.

Using the native controls on your connected device, make sure the audio settings are set to ARC or HDMI Audio and are turned on. Audio from the connected audio source will now be played through the speakers.

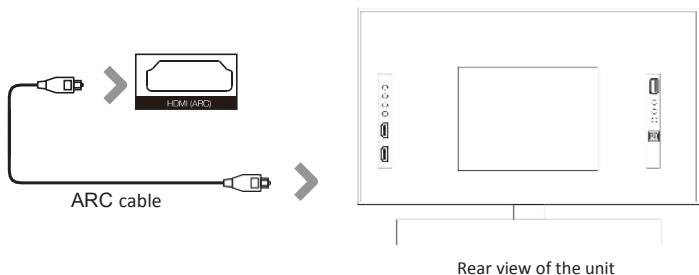

Using the Optical Input

You will need: An audio source with an Optical Audio Output and a Digital Optical Audio cable (not included).

Connect the Digital Optical Audio cable to the optical output on the audio source and to the Optical Input on the soundbar.

Press the POWER button on the sound bar or POWER button directly on the remote control (**Rem.1**) to switch on the unit.

Press the MODE button on the remote control (**Rem.23**) to switch to Optical mode or select the Mode button on main unit repeatedly to select the Optical mode.

Using the native controls on your connected device, make sure the audio settings are set to PCM or Optical Audio and are turned On. Audio from the connected audio source will now be played through the speakers.

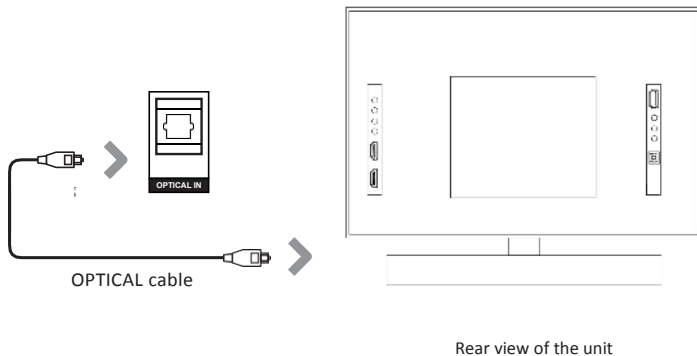

Instructions Guide

Using the MP3 Link Connection (Line In)

Plug one end of a 3.5mm to 3.5mm Line In cable (included) into the Line In port on the unit. Before use, disconnect any cables connected to the Stereo RCA Inputs.

Plug the other end of the cable into the audio output/headphone output on an MP3 player or other audio source.

Press the Power button on the soundbar or POWER button directly on the remote control (**Rem.1**) to switch on the unit.

Press the Mode button repeatedly on the soundbar or press the MODE button on remote control (**Rem.22**) repeatedly to enter LINE in mode.

Audio played through the connected device will now be heard through the speakers.

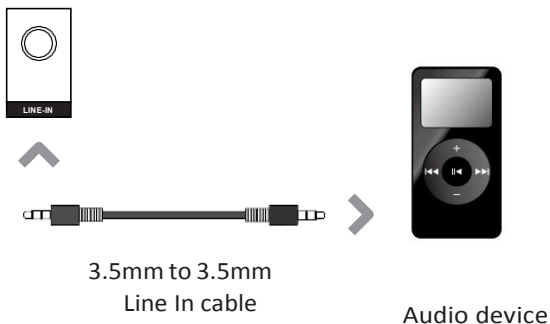

Connecting to the Mains Supply

Ensure that the power supply voltage is in the voltage of 100V~240V.

This unit is designed to use adapter.

Connecting the unit to any other power source may cause damage to the unit.

Unwind the mains cable to its full length.

Connect the mains plug to a mains socket.

Make sure the mains plug is fully inserted into the mains socket.

Connect the adapter to the unit via the DC input Socket.
(DC-24V-IN)

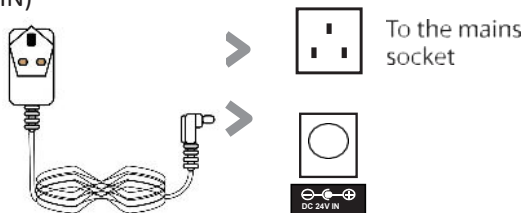

DC-In Power Cable



Ensure all audio connections of the unit are connected before connecting to the mains power socket.

Unplug the power cord from the outlet when the unit is use for an extended period of time.

Using the Bluetooth Operation

Pairing a Bluetooth Device for the First Time

Press the POWER button on the unit or the POWER button on the remote control (**Rem.1**) to switch on the unit.

Select and press the MODE button repeatedly on the remote control until in Bluetooth mode (**Rem.21**) or press the Mode button repeatedly on the sound bar to enter Bluetooth mode.

Using the native controls on your Bluetooth device, select the “Majority Everest” in your Bluetooth settings to pair.

Refer to the user manual for your specific device for instructions on pairing and connecting Bluetooth devices.

When successfully paired and connected, a beep will issue from the unit. After initial pairing, the unit will stay paired unless unpaired manually by the user.

If your device should become unpaired or you find it is unable to connect, repeat the above steps.

Playing Audio Wirelessly

Follow the instructions for pairing a Bluetooth device.

Use the native controls on the connected Bluetooth Device to select a track.

To Play/Pause the track or Skip Forwards/Backwards to a selected track, use the remote control (**Rem.17,14,15**).

Audio played through the connected Bluetooth device will now be heard through the speakers.

Using the USB Operation

Insert USB to Play Music Automatically.

Select and press the MODE button repeatedly on the remote control until in USB mode (Rem.24) or press the Mode button repeatedly on the soundbar to enter USB mode.

To Play/Pause the track or Skip Forwards/Backwards to a selected track, use the remote control (**Rem.17,14,15**).

Audio played through the connected USB device will now be heard through the speakers.

Troubleshooting

If the soundbar does not work properly as desired, please check the following.

Malfunction	Possible causes/measures
No power / function	Check whether the power is switched on or off at the wall. Check whether the power adaptor is properly connected to power outlet or not.
No sound	Check whether cables are properly installed. If they are, please try alternative cable to connect to your TV if possible. Check unit is out of standby and in mode.
No sound from bluetooth connection	Forget the soundbar from your device and reconnect.
Function disturbance	Switch off and unplug the unit. Leave it for 2 minutes and switch it on again. If a particular mode is causing problems, please try an alternative connection to your TV such as Optical or Bluetooth.
Remote control does not work [properly]	Check whether the battery run out or not. Replace with a new one if necessary. Check whether there is obstacle on the front of remote sensor.

Specifications

Power Supply (Soundbar)	DC 24V / 2.0A
Power Supply (Subwoofer)	DC 18V / 2A
Power Supply (Surround Speaker)	DC 5V / 2A
Power Supply (Surround Speaker)	DC 3.7V / 3600mA Built-in Battery
Surrounds Built-in Battery Playing Time	4 Hours (at maximum volume)
Power Consumption	100W
Speaker Size & Number of Speakers (Soundbar)	2.25" Full Ranges Speaker x 2 + 2.25" Mid-Tweeter x 4
Speaker Size (Subwoofer)	5.25 Inch x 1
Speaker Size & Number of Speakers (Surround Speaker)	2.25" Full Ranges Speaker x 2
Working Environment (Temperature)	-10~ + 55C
Relative Humidity	5% ~ 90%
Frequency Response	70Hz - 15KHz
Bluetooth Version	V 5.0
Bluetooth Distance	≥10M
Connection subwoofer with Soundbar by	UHF 865MHz ≥ 10M
Connection left surround with Soundbar by	UHF 756MHz ≥ 10M
Connection right surround with Soundbar by	UHF 676MHz ≥ 10M
Dimension (LxDxH)	90 x 9.83 x 6.56 cm (Soundbar)
Dimension (LxDxH)	3 1 x 28 x 17cm (Subwoofer)
Dimension (LxDxH)	9.83 x 6.56 x 16.8 cm (Surround)

Hang the soundbar

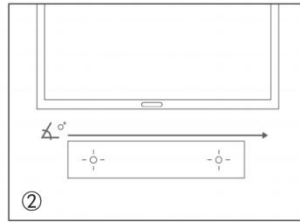
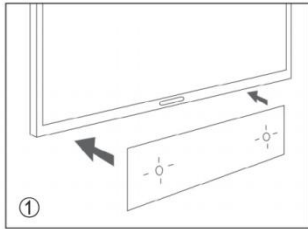

Place the paper guide on the wall where you want to hang the soundbar.

Verify with a level gauge that the inclination angle of the soundbar is zero degrees.

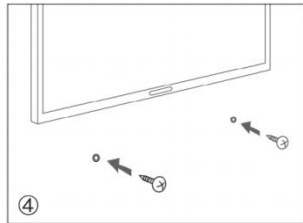
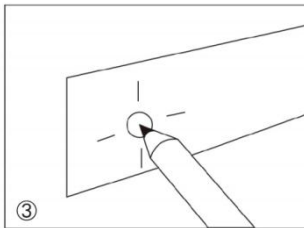

Locate the screw holes on the paper guide and mark a point with a pencil.

Make the holes with the corresponding drill bit according to the type of wall.

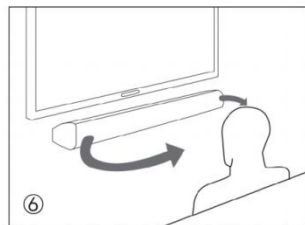
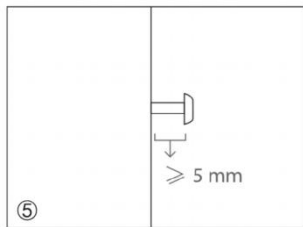

It is advisable to leave no more than 5mm between the head of the screw and the wall to minimize the inclination angle of the soundbar.

For a better sound experience, it is advisable to place the soundbar at the same height of the ear.

Hang the surround speaker

Step 1: Fix a point

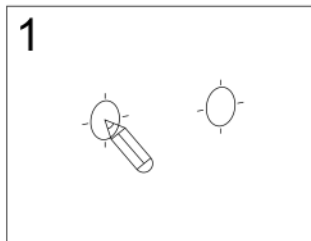

Use a pencil to fix a point

Step 2: Punch

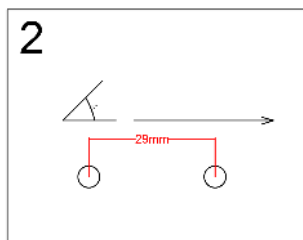

Use a level to check whether the two holes are tilted, and drill holes based on the actual hole spacing of wall mount adaptor

Step 3: Fix the wall mount adaptor

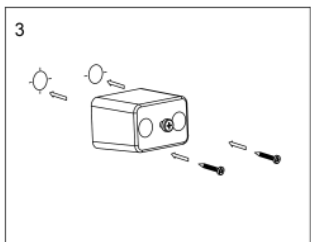

After drilling the hole, tighten the wall mount adaptor with the screws provided

Step 4: Install the surround speaker

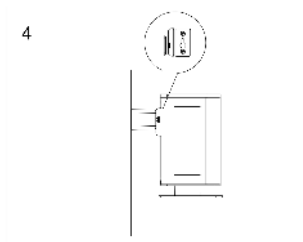

Align the hook hole of the speaker with the protruding screw of the wall mount adaptor, and hang

Quick System Installation Guide

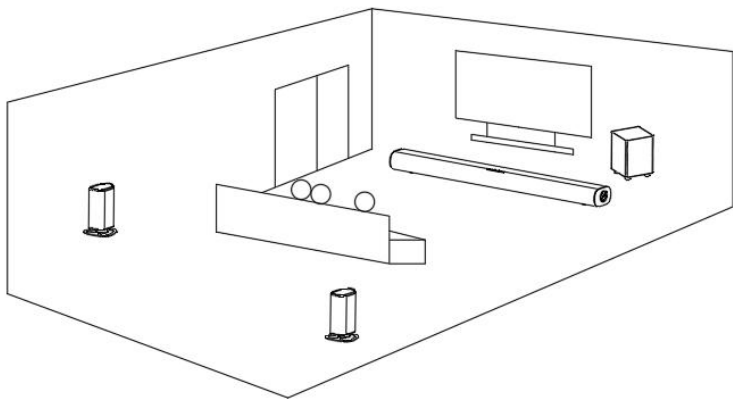

When all the kits connecting with power supply, the subwoofer is flat placed in the middle under the soundbar, or placed closely on the left and right side of the soundbar, but not too far from the soundbar.

Detached Surround Speaker from main Soundbar to be Standing Speaker. Each wireless surround speaker is flat placed on the left and right sides of the sofa, their speakers are facing right and left ears of people setting on the sofa.

For a better sound, the distance from left & right surround speaker to the soundbar cannot be far than 10 meters, it is better within 7 meters.

Soundbar is supported to hang on the wall by installing with a screw.

1. Read these user manual.
2. Keep these user manual.
3. Heed all Warnings
4. Follow all instructions
5. Do not clean the apparatus near or with water
6. Do not block any ventilation openings. Install in accordance with the manufacturer's instructions
7. Do not install near any heat sources such as radiators, heat registers, stoves, or other apparatus (including amplifiers) that produce heat.
8. Protect the power from being walked on or pinched particularly at plugs, convenience receptacles, and the point where they exit from the apparatus.
9. Only use attachments/accessories specified by the manufacturer.
10. Unplug this apparatus during light storms or when unused for long periods of time.
11. Refer all servicing to qualified service personnel. Servicing is required when the apparatus has been damaged in a way, such as power-supply cord or plug is damaged, liquid has been spilled or objects have fallen into the apparatus, the apparatus has been exposed to the rain or moisture, does not operate normally or has been dropped.
12. No naked flame sources, such as lit candles, should be placed on the apparatus.
13. Dispose of used electrical products and batteries safely according to your local authority and regulations.

ADDITIONAL WARNINGS

The apparatus shall not be exposed to dripping or splashing and no objects filled with liquid, such as vases, shall be placed on the apparatus.

Main plug is used to disconnect device and it should remain readily operable during intended use. In order to disconnect the apparatus from the main mains completely, the mains plug should be disconnected from the main socket outlet completely.

Battery shall not be exposed to excessive heat such as sunshine, fire or the like.

RECYCLING ELECTRICAL PRODUCTS

You should now recycle your waste electrical goods and in doing so help the environment.



This symbol means an electrical product should not be disposed of with normal household waste.

Please ensure it is taken to a suitable facility for disposal when finished with.

IMPORTANT: Please read all instructions carefully before use and keep for future reference.



Risk of electric shock.
Do not open



Read all instructions carefully before use and keep for future reference



When servicing, use only identical replacement parts



CAUTION

RISK OF ELECTRIC SHOCK DO NOT OPEN



IMPORTANT: Please read all instructions carefully before use and keep for future reference.