

DENON
PROFESSIONAL

CD/Media Player

DN-501C

Owner's Manual

IMPORTANT TO SAFETY

WARNING:

To reduce the risk of fire and electric shock, this apparatus should not be exposed to rain or moisture and objects filled with liquids, such as vases, should not be placed on this apparatus

CAUTION

1. Handle the power supply cord carefully

Do not damage or deform the power supply cord. If it is damaged or deformed, it may cause electric shock or malfunction when used. When removing from wall outlet, be sure to remove by holding the plug attachment and not by pulling the cord.

2. Do not open the rear cover

In order to prevent electric shock, do not open the top cover. If problems occur, contact your DENON DEALER.

3. Do not place anything inside

Do not place metal objects or spill liquid inside the system. Electric shock or malfunction may result.

Please, record and retain the Model name and serial number of your set shown on the rating label.

Model No. DN-501C

Serial No. _____



CAUTION
RISK OF ELECTRIC SHOCK
DO NOT OPEN



CAUTION:

TO REDUCE THE RISK OF ELECTRIC SHOCK, DO NOT REMOVE COVER (OR BACK). NO USER-SERVICEABLE PARTS INSIDE. REFER SERVICING TO QUALIFIED SERVICE PERSONNEL.



The lightning flash with arrowhead symbol, within an equilateral triangle, is intended to alert the user to the presence of uninsulated "dangerous voltage" within the product's enclosure that may be of sufficient magnitude to constitute a risk of electric shock to persons.



The exclamation point within an equilateral triangle is intended to alert the user to the presence of important operating and maintenance (servicing) instructions in the literature accompanying the appliance.

FCC INFORMATION (For US customers)

1. COMPLIANCE INFORMATION

Product Name: CD/MEDIA PLAYER

Model Number: DN-501C

This product complies with Part 15 of the FCC Rules. Operation is subject to the following two conditions: (1) this product may not cause harmful interference, and (2) this product must accept any interference received, including interference that may cause undesired operation.

DENON Professional div. D&M Professional
1100 Maplewood Drive Itasca, IL 60143
Tel. 630-741-0330

2. IMPORTANT NOTICE: DO NOT MODIFY THIS PRODUCT

This product, when installed as indicated in the instructions contained in this manual, meets FCC requirements. Modification not expressly approved by DENON may void your authority, granted by the FCC, to use the product.

3. NOTE

This product has been tested and found to comply with the limits for a Class B digital device, pursuant to Part 15 of the FCC Rules. These limits are designed to provide reasonable protection against harmful interference in a residential installation.

This product generates, uses and can radiate radio frequency energy and, if not installed and used in accordance with the instructions, may cause harmful interference to radio communications. However, there is no guarantee that interference will not occur in a particular installation. If this product does cause harmful interference to radio or television reception, which can be determined by turning the product OFF and ON, the user is encouraged to try to correct the interference by one or more of the following measures:

- Reorient or relocate the receiving antenna.
- Increase the separation between the equipment and receiver.
- Connect the product into an outlet on a circuit different from that to which the receiver is connected.
- Consult the local retailer authorized to distribute this type of product or an experienced radio/TV technician for help.

CAN ICES-3(B)/NMB-3(B)

IMPORTANT SAFETY INSTRUCTIONS

READ BEFORE OPERATING EQUIPMENT

This product was designed and manufactured to meet strict quality and safety standards. There are, however, some installation and operation precautions which you should be particularly aware of.

1. Read these instructions.
2. Keep these instructions.
3. Heed all warnings.
4. Follow all instructions.
5. Do not use this apparatus near water.
6. Clean only with dry cloth.
7. Do not block any ventilation openings. Install in accordance with the manufacturer's instructions.
8. Do not install near any heat sources such as radiators, heat registers, stoves, or other apparatus (including amplifiers) that produce heat.
9. Do not defeat the safety purpose of the polarized or grounding-type plug. A polarized plug has two blades with one wider than the other. A grounding type plug has two blades and a third grounding prong. The wide blade or the third prong are provided for your safety. If the provided plug does not fit into your outlet, consult an electrician for replacement of the obsolete outlet.
10. Protect the power cord from being walked on or pinched particularly at plugs, convenience receptacles, and the point where they exit from the apparatus.
11. Only use attachments/accessories specified by the manufacturer.
12. Use only with the cart, stand, tripod, bracket, or table specified by the manufacturer, or sold with the apparatus. When a cart is used, use caution when moving the cart/apparatus combination to avoid injury from tip-over.
13. Unplug this apparatus during lightning storms or when unused for long periods of time.
14. Refer all servicing to qualified service personnel. Servicing is required when the apparatus has been damaged in any way, such as power-supply cord or plug is damaged, liquid has been spilled or objects have fallen into the apparatus, the apparatus has been exposed to rain or moisture, does not operate normally, or has been dropped.
15. Batteries shall not be exposed to excessive heat such as sunshine, fire or the like.



Additional Safety Information!

16. This product is equipped with a three-wire grounding type plug, a plug having a third (grounding) pin. This plug will only fit into a grounding-type power outlet. If you are unable to insert the plug into the outlet, contact your electrician to replace your obsolete outlet. Do not defeat the safety purpose of the grounding-type plug.

Laser Class
(IEC60825-1:2007)
CLASS 1 LASER PRODUCT
LUOKAN 1 LASERLAITE
KLASS 1 LASERAPPARAT

"CLASS 1
LASER PRODUCT"

ADVARSEL: USYNLIG LASERSTRÅLING VED ÅBNING, NÅR SIKKERHEDSAFBRYDERE ER UDE AF FUNKTION.
UNDGÅ UDSAETTELSE FOR STRÅLING.

VAROITUS! LAITTEEN KÄYTTÄMINEN MUULLA KUIN TÄSSÄ KÄYTTÖOHJEESSA MAINITULLA TAVALLA SAATTA
ALTISTAA KÄYTTÄJÄN TURVALLISUUSLUOKAN 1 YLITTÄVÄLLE NÄKYMÄMTTÖMÄLLE LASERSÄTEILYLLE.

WARNING: OM APPARATEN ANVÄNDS PÅ ANNAT SÄTT ÄN I DENNA BRUKSANVISNING SPECIFICERATS, KAN ANVÄNDAREN UTSÄTTAS FÖR OSYNLIG LASERSTRÅLNING SOM ÖVERSKRIDER GRÄNSEN FÖR LASERKLASS 1.



ATTENZIONE: QUESTO APPARECCHIO E' DOTATO DI DISPOSITIVO OTTICO CON RAGGIO LASER.
L'USO IMPROPRIO DELL'APPARECCHIO PUO' CAUSARE PERICOLOSE ESPOSIZIONI A RADIAZIONI!!

CAUTION:
USE OF CONTROLS OR ADJUSTMENTS OR PERFORMANCE OF PROCEDURES OTHER THAN THOSE SPECIFIED HEREIN MAY RESULT IN HAZARDOUS RADIATION EXPOSURE.
THIS PRODUCT SHOULD NOT BE ADJUSTED OR REPAIRED BY ANYONE EXCEPT PROPERLY QUALIFIED SERVICE PERSONNEL.

CAUTION: (English)

To completely disconnect this product from the mains, disconnect the plug from the wall socket outlet.

The mains plug is used to completely interrupt the power supply to the unit and must be within easy access by the user.

Do not expose batteries to excessive heat such as sunshine, fire or the like.

VORSICHT: (Deutsch)

Um dieses Gerät vollständig von der Stromversorgung abzutrennen, trennen Sie bitte den Netzstecker von der Wandsteckdose ab.

Die Hauptstecker werden verwendet, um die Stromversorgung zum Gerät völlig zu unterbrechen; er muss für den Benutzer gut und einfach zu erreichen sein. Setzen Sie Batterien nicht übermäßiger Wärme aus, z. B. Sonnenstrahlung, Feuer oder dergleichen.

PRECAUTION: (Français)

Pour déconnecter complètement ce produit du courant secteur, débranchez la prise de la prise murale.

La prise secteur est utilisée pour couper complètement l'alimentation de l'appareil et l'utilisateur doit pouvoir y accéder facilement.

N'exposez pas les batteries à une chaleur excessive telle que le soleil, le feu ou autre.

ATTENZIONE: (Italiano)

Per scollegare definitivamente questo prodotto dalla rete di alimentazione elettrica, togliere la spina dalla relativa presa.

La spina di rete viene utilizzata per interrompere completamente l'alimentazione all'unità e deve essere facilmente accessibile all'utente.

Non esporre le batterie a un calore eccessivo, per esempio al sole, al fuoco o altre fonti.

PRECAUCIÓN: (Español)

Para desconectar completamente este producto de la alimentación eléctrica, desconecte el enchufe del enchufe de la pared.

El enchufe de la alimentación se utiliza para interrumpir por completo el suministro de alimentación a la unidad y debe de encontrarse en un lugar al que el usuario tenga fácil acceso.

No exponga las pilas a calor excesivo, como a la luz solar, el fuego, etc.

VOORZICHTIGHEID: (Nederlands)

Om de voeding van dit product volledig te onderbreken moet de stekker uit het stopcontact worden getrokken.

De netstekker wordt gebruikt om de stroomtoevoer naar het toestel volledig te onderbreken en moet voor de gebruiker gemakkelijk bereikbaar zijn.

Stel de batterijen niet bloot aan felle zonneschijn, brand, enzovoorts.

FÖRSIKTIHETSMÅTT: (Svenska)

Koppla loss stickproppen från eluttaget för att helt skilja produkten från nätet.

Stickproppen används för att helt bryta strömförsörjningen till apparaten, och den måste vara lättillgänglig för användaren.

Utsätt inte batterierna för stark hetta såsom solsken, eld eller liknande.

ATENÇÃO: (Português)

Para desligar completamente este produto da corrente, desligue a ficha da tomada eléctrica.

A ficha eléctrica é utilizada para interromper completamente a alimentação da unidade e deve estar num local onde o utilizador lhe possa aceder facilmente.

Não exponha as pilhas a fontes de calor excessivo, como luz solar, fogo ou semelhantes.

NOTE ON USE / HINWEISE ZUM GEBRAUCH

WARNINGS	WARNHINWEISE
<ul style="list-style-type: none"> • Avoid high temperatures. Allow for sufficient heat dispersion when installed in a rack. • Handle the power cord carefully. Hold the plug when unplugging the cord. • Keep the unit free from moisture, water, and dust. • Unplug the power cord when not using the unit for long periods of time. • Do not obstruct the ventilation holes. • Do not let foreign objects into the unit. • Do not let insecticides, benzene, and thinner come in contact with the unit. • Never disassemble or modify the unit in any way. • Ventilation should not be impeded by covering the ventilation openings with items, such as newspapers, tablecloths or curtains. • Naked flame sources such as lighted candles should not be placed on the unit. • Observe and follow local regulations regarding battery disposal. • Do not expose the unit to dripping or splashing fluids. • Do not place objects filled with liquids, such as vases, on the unit. • Do not handle the mains cord with wet hands. • When the switch is in the OFF (STANDBY) position, the equipment is not completely switched off from MAINS. • The equipment shall be installed near the power supply so that the power supply is easily accessible. • Do not keep the battery in a place exposed to direct sunlight or in places with extremely high temperatures, such as near a heater. 	<ul style="list-style-type: none"> • Vermeiden Sie hohe Temperaturen. Beachten Sie, dass eine ausreichende Belüftung gewährleistet wird, wenn das Gerät auf ein Regal gestellt wird. • Gehen Sie vorsichtig mit dem Netzkabel um. Halten Sie das Kabel am Stecker, wenn Sie den Stecker herausziehen. • Halten Sie das Gerät von Feuchtigkeit, Wasser und Staub fern. • Wenn das Gerät längere Zeit nicht verwendet werden soll, trennen Sie das Netzkabel vom Netzstecker. • Decken Sie den Lüftungsbereich nicht ab. • Lassen Sie keine fremden Gegenstände in das Gerät kommen. • Lassen Sie das Gerät nicht mit Insektiziden, Benzin oder Verdünnungsmitteln in Berührung kommen. • Versuchen Sie niemals das Gerät auseinander zu nehmen oder zu verändern. • Die Belüftung sollte auf keinen Fall durch das Abdecken der Belüftungsöffnungen durch Gegenstände wie beispielsweise Zeitungen, Tischtücher, Vorhänge o. Ä. behindert werden. • Auf dem Gerät sollten keinerlei direkte Feuerquellen wie beispielsweise angezündete Kerzen aufgestellt werden. • Bitte beachten Sie bei der Entsorgung der Batterien die örtlich geltenden Umweltbestimmungen. • Das Gerät sollte keiner tropfenden oder spritzenden Flüssigkeit ausgesetzt werden. • Auf dem Gerät sollten keine mit Flüssigkeit gefüllten Behälter wie beispielsweise Vasen aufgestellt werden. • Das Netzkabel nicht mit feuchten oder nassen Händen anfassen. • Wenn der Schalter ausgeschaltet ist (OFF (STANDBY)-Position), ist das Gerät nicht vollständig vom Stromnetz (MAINS) abgetrennt. • Das Gerät sollte in der Nähe einer Netzsteckdose aufgestellt werden, damit es leicht an das Stromnetz angeschlossen werden kann. • Lagern Sie die Batterie nicht an einem Ort, an dem sie direktem Sonnenlicht oder extrem hohen Temperaturen ausgesetzt ist, wie z. B. in der Nähe eines Heizgeräts.

☐ OBSERVATIONS RELATIVES A L'UTILISATION / NOTE SULL'USO / NOTAS SOBRE EL USO / ALVORENS TE GEBRUIKEN / OBSERVERA / NOTA SOBRE UTILIZAÇÃO

AVERTISSEMENTS	AVVERTENZE	ADVERTENCIAS	WAARSCHUWINGEN	VARNINGAR	AVISOS
<ul style="list-style-type: none"> • Eviter des températures élevées. Tenir compte d'une dispersion de chaleur suffisante lors de l'installation sur une étagère. • Manipuler le cordon d'alimentation avec précaution. Tenir la prise lors du débranchement du cordon. • Protéger l'appareil contre l'humidité, l'eau et la poussière. • Débrancher le cordon d'alimentation lorsque l'appareil n'est pas utilisé pendant de longues périodes. • Ne pas obstruer les trous d'aération. • Ne pas laisser des objets étrangers dans l'appareil. • Ne pas mettre en contact des insecticides, du benzène et un diluant avec l'appareil. • Ne jamais démonter ou modifier l'appareil d'une manière ou d'une autre. • Ne pas recouvrir les orifices de ventilation avec des objets tels que des journaux, nappes ou rideaux. Cela entraverait la ventilation. • Ne jamais placer de flamme nue sur l'appareil, notamment des bougies allumées. • Veillez à respecter les lois en vigueur lorsque vous jetez les piles usagées. • L'appareil ne doit pas être exposé à l'eau ou à l'humidité. • Ne pas poser d'objet contenant du liquide, par exemple un vase, sur l'appareil. • Ne pas manipuler le cordon d'alimentation avec les mains mouillées. • Lorsque l'interrupteur est sur la position OFF (STANDBY), l'appareil n'est pas complètement déconnecté du SECTEUR (MAINS). • L'appareil sera installé près de la source d'alimentation, de sorte que cette dernière soit facilement accessible. • Ne placez pas la pile dans un endroit exposé à la lumière directe du soleil ou dans des endroits présentant des températures extrêmement élevées, par exemple près d'un radiateur. 	<ul style="list-style-type: none"> • Evitate di esporre l'unità a temperature elevate. Assicuratevi che vi sia un'adeguata dispersione del calore quando installate l'unità in un mobile per componenti audio. • Maneggiate il cavo di alimentazione con attenzione. Tenete ferma la spina quando scollegate il cavo dalla presa. • Tenete l'unità lontana dall'umidità, dall'acqua e dalla polvere. • Scollegate il cavo di alimentazione quando prevedete di non utilizzare l'unità per un lungo periodo di tempo. • Non coprite i fori di ventilazione. • Non inserite corpi estranei all'interno dell'unità. • Assicuratevi che l'unità non entri in contatto con insetticidi, benzolo o solventi. • Non smontate né modificate l'unità in alcun modo. • Le aperture di ventilazione non devono essere ostruite coprendole con oggetti, quali giornali, tovaglie, tende e così via. • Non posizionate sull'unità fiamme libere, come ad esempio candele accese. • Prestate attenzione agli aspetti legati alla tutela dell'ambiente nello smaltimento delle batterie. • L'apparecchiatura non deve essere esposta a goccioli o spruzzi. • Non posizionate sull'unità alcun oggetto contenente liquidi, come ad esempio i vasi. • Non toccare il cavo di alimentazione con le mani bagnate. • Quando l'interruttore è nella posizione OFF (STANDBY), l'apparecchiatura non è completamente scollegata da MAINS. • L'apparecchio va installato in prossimità della fonte di alimentazione, in modo che quest'ultima sia facilmente accessibile. • Non tenere la batteria in luoghi esposti alla luce solare diretta o con temperature estremamente elevate, ad esempio in prossimità di dispositivi di riscaldamento. 	<ul style="list-style-type: none"> • Evite altas temperaturas. Permite la suficiente dispersión del calor cuando está instalado en la consola. • Maneje el cordón de energía con cuidado. Sostenga el enchufe cuando desconecte el cordón de energía. • Mantenga el equipo libre de humedad, agua y polvo. • Desconecte el cordón de energía cuando no utilice el equipo por mucho tiempo. • No obstruya los orificios de ventilación. • No deje objetos extraños dentro del equipo. • No permita el contacto de insecticidas, gasolina y diluyentes con el equipo. • Nunca desarme o modifique el equipo de ninguna manera. • La ventilación no debe quedar obstruida por haberse cubierto las aperturas con objetos como periódicos, manteles o cortinas. • No deberán colocarse sobre el aparato fuentes inflamables sin protección, como velas encendidas. • A la hora de deshacerse de las pilas, respete la normativa para el cuidado del medio ambiente. • No exponer el aparato al goteo o salpicaduras cuando se utilice. • No colocar sobre el aparato objetos llenos de líquido, como jarros. • No maneje el cable de alimentación con las manos mojadas. • Cuando el interruptor está en la posición OFF (STANDBY), el equipo no está completamente desconectado de la alimentación MAINS. • El equipo se instalará cerca de la fuente de alimentación de manera que resulte fácil acceder a ella. • No coloque las pilas en un lugar expuesto a la luz directa del sol o donde la temperatura sea extremadamente alta, como cerca de una calefacción. 	<ul style="list-style-type: none"> • Vermijd hoge temperaturen. Zorg er bij installatie in een audiorack voor, dat de door het toestel geproduceerde warmte goed kan worden afgevoerd. • Hanteer het netsnoer voorzichtig. Houd het snoer bij de stekker vast wanneer deze moet worden aan- of losgekoppeld. • Laat geen vochtigheid, water of stof in het apparaat binnendringen. • Neem altijd het netsnoer uit het stopcontact wanneer het apparaat gedurende een lange periode niet wordt gebruikt. • De ventilatieopeningen mogen niet worden geblokkeerd. • Laat geen vreemde voorwerpen in dit apparaat vallen. • Voorkom dat insecticiden, benzeen of verfverdunder met dit toestel in contact komen. • Dit toestel mag niet gedemonteerd of aangepast worden. • De ventilatie mag niet worden belemmerd door de ventilatieopeningen af te dekken met bijvoorbeeld kranten, een tafelkleed of gordijnen. • Plaats geen open vlammen, bijvoorbeeld een brandende kaars, op het apparaat. • Houd u steeds aan de milieuvorschriften wanneer u gebruikte batterijen wegdoet. • Stel het apparaat niet bloot aan druppels of spatten. • Plaats geen voorwerpen gevuld met water, bijvoorbeeld een vaas, op het apparaat. • Raak het netsnoer niet met natte handen aan. • Als de schakelaar op OFF (STANDBY) staat, is het apparaat niet volledig losgekoppeld van de netspanning (MAINS). • De apparatuur wordt in de buurt van het stopcontact geïnstalleerd, zodat dit altijd gemakkelijk toegankelijk is. • Bewaar de batterijen niet op een plaats waar deze blootstaan aan direct zonlicht of op plaatsen waar zeer hoge temperaturen heersen, zoals in de buurt van een kachel. 	<ul style="list-style-type: none"> • Undvik höga temperaturer. Se till att det finns möjlighet till god värmeavledning vid montering i ett rack. • Hantera nätkabeln varsamt. Håll i kabeln när den kopplas från el-uttaget. • Utsätt inte apparaten för fukt, vatten och damm. • Koppla loss nätkabeln om apparaten inte kommer att användas i lång tid. • Tapp inte till ventilationsöppningarna. • Se till att främmande föremål inte tränger in i apparaten. • Se till att inte insektsmedel på spraybruk, bensen och thinner kommer i kontakt med apparatens hölje. • Ta inte isär apparaten och försök inte bygga om den. • Ventilationen bör inte förhindras genom att täcka för ventilationsöppningarna med föremål såsom tidningar, bordsdukar eller gardiner. • Placera inte öppen eld, t.ex. tända ljus, på apparaten. • Tänk på miljöaspekterna när du bortskaffar batterier. • Apparaten får inte utsättas för vätska. • Placera inte föremål fyllda med vätska, t.ex. vaser, på apparaten. • Hantera inte nätsladden med våta händer. • Även om strömbrytaren står i det avstängda läget OFF (STANDBY), så är utrustningen inte helt bortkopplad från det elektriska nätet (MAINS). • Utrustningen ska vara installerad nära strömuttaget så att strömförsörjningen är lätt att tillgå. • Förvara inte batteriet på en plats som utsätts för direkt solljus eller på platser med extremt höga temperaturer, som nära ett värmeelement. 	<ul style="list-style-type: none"> • Evite temperaturas altas. Assegure uma suficiente dispersão de calor quando a unidade for instalada numa prateleira. • Manuseie o cabo de alimentação com cuidado. Puxe pela ficha quando desligar o cabo de alimentação. • Mantenha a unidade afastada da humidade, da água e do pó. • Desligue o cabo de alimentação quando não estiver a utilizar a unidade por longos períodos de tempo. • Não obstrua os orifícios de ventilação. • Não deixe objectos estranhos dentro da unidade. • Não permita que insecticidas, benzina e diluente entrem em contacto com a unidade. • Nunca desmonte ou modifique de alguma forma a unidade. • A ventilação não deve ser obstruída, tapando as aberturas de ventilação com objectos, como jornais, toalhas ou cortinas. • Não devem ser colocadas junto à unidade fontes de chama aberta, como velas acesas. • Respeite as regulamentações locais relativas à eliminação de pilhas. • Não exponha a unidade a gotejamento ou salpicos de líquidos. • Não coloque objectos com líquidos, como jarros, em cima da unidade. • Não manuseie o cabo de alimentação com as mãos molhadas. • Quando o interruptor se encontra na posição OFF (STANDBY), o equipamento não está completamente desligado da REDE ELÉCTRICA. • O equipamento deve ser instalado junto da fonte de alimentação, para que a fonte de alimentação esteja facilmente acessível. • Não deixe a pilha num local exposto à luz solar directa ou em locais sujeitos a temperaturas extremamente elevadas, como, por exemplo, junto de um aquecedor.

• DECLARATION OF CONFORMITY

Our products following the provisions of EC/EU directives, that as follows:

LV: 2006/95/EC

EMC: 2004/108/EC

RoHS: 2011/65/EU

ErP: EC regulation 1275/2008 and its frame work directive 2009/125/EC

• ÜBEREINSTIMMUNGSERKLÄRUNG

Unsere Produkte unterliegen den Bestimmungen der folgenden EG/EU-Richtlinien:

LV: 2006/95/EC

EMC: 2004/108/EC

RoHS: 2011/65/EU

ErP: EG-Vorschrift 1275/2008 und deren Rahmenrichtlinie 2009/125/EC

• DECLARATION DE CONFORMITE

Nos produits sont conformes aux dispositions des directives CE/UE comme suit :

LV: 2006/95/EC

EMC: 2004/108/EC

RoHS: 2011/65/EU

ErP: Réglementation CE 1275/2008 et sa directive cadre 2009/125/CE

• DICHIARAZIONE DI CONFORMITÀ

I nostri prodotti sono conformi a quanto previsto dalle direttive EC/EU, come specificato di seguito:

LV: 2006/95/EC

EMC: 2004/108/EC

RoHS: 2011/65/EU

ErP: Norma EC 1275/2008 e relativa legge quadro 2009/125/EC

• DECLARACIÓN DE CONFORMIDAD

Nuestros productos cumplen las disposiciones de las directivas de la CE/UE siguientes:

LV: 2006/95/EC

EMC: 2004/108/EC

RoHS: 2011/65/EU

ErP: Normativa de la CE 1275/2008 y su directiva marco 2009/125/CE

• EENVORMIGHEIDSVKLAARING

Onze producten volgen de voorwaarden van de EG/EU-richtlijnen zoals volgt;

LV: 2006/95/EC

EMC: 2004/108/EC

RoHS: 2011/65/EU

ErP: EG-verordening 1275/2008 en zijn kaderrichtlijn 2009/125/EG

• ÖVERENSSTÄMMELSESINTYG

Våra produkter uppfyller följande föreskrifter i EC/EU-direktiv:

LV: 2006/95/EC

EMC: 2004/108/EC

RoHS: 2011/65/EU

ErP: EU-direktiv 1275/2008 och dess ramdirektiv 2009/125/EC

• DECLARAÇÃO DE CONFORMIDADE

Nossos produtos seguem as disposições da CE / UE directivas, que, como se segue;

LV: 2006/95/EC

EMC: 2004/108/EC

RoHS: 2011/65/EU

ErP: Regulamento (CE) 1275/2008 e a respectiva Directiva-Quadro 2009/125/CE

D&M Professional Europe
A division of D&M Europe B.V
Beemdstraat 11
5653 MA Eindhoven
The Netherlands

A NOTE ABOUT RECYCLING:

This product's packaging materials are recyclable and can be reused. Please dispose of any materials in accordance with the local recycling regulations.

When discarding the unit, comply with local rules or regulations.

Batteries should never be thrown away or incinerated but disposed of in accordance with the local regulations concerning battery disposal.

This product and the supplied accessories, excluding the batteries, constitute the applicable product according to the WEEE directive.

HINWEIS ZUM RECYCLING:

Das Verpackungsmaterial dieses Produktes ist zum Recyceln geeignet und kann wieder verwendet werden. Bitte entsorgen Sie alle Materialien entsprechend der örtlichen Recycling-Vorschriften.

Beachten Sie bei der Entsorgung des Gerätes die örtlichen Vorschriften und Bestimmungen.

Die Batterien dürfen nicht in den Hausmüll geworfen oder verbrannt werden; bitte entsorgen Sie die Batterien gemäß der örtlichen Vorschriften.

Dieses Produkt und das im Lieferumfang enthaltene Zubehör (mit Ausnahme der Batterien!) entsprechen der WEEE-Direktive.

UNE REMARQUE CONCERNANT LE RECYCLAGE:

Les matériaux d'emballage de ce produit sont recyclables et peuvent être réutilisés. Veuillez disposer des matériaux conformément aux lois sur le recyclage en vigueur.

Lorsque vous mettez cet appareil au rebut, respectez les lois ou réglementations en vigueur.

Les piles ne doivent jamais être jetées ou incinérées, mais mises au rebut conformément aux lois en vigueur sur la mise au rebut des piles.

Ce produit et les accessoires inclus, à l'exception des piles, sont des produits conformes à la directive DEEE.

NOTA RELATIVA AL RICICLAGGIO:

I materiali di imballaggio di questo prodotto sono riutilizzabili e riciclabili. Smaltire i materiali conformemente alle normative locali sul riciclaggio.

Per lo smaltimento dell'unità, osservare le normative o le leggi locali in vigore.

Non gettare le batterie, né incenerirle, ma smaltirle conformemente alla normativa locale sui rifiuti chimici.

Questo prodotto e gli accessori inclusi nell'imballaggio sono applicabili alla direttiva RAEE, ad eccezione delle batterie.

ACERCA DEL RECICLAJE:

Los materiales de embalaje de este producto son reciclables y se pueden volver a utilizar. Disponga de estos materiales siguiendo los reglamentos de reciclaje de su localidad.

Cuando se deshaga de la unidad, cumpla con las reglas o reglamentos locales.

Las pilas nunca deberán tirarse ni incinerarse. Deberá disponer de ellas siguiendo los reglamentos de su localidad relacionados con los desperdicios químicos.

Este producto junto con los accesorios empaquetados es el producto aplicable a la directiva RAEE excepto pilas.

EEN AANTEKENING MET BETREKKING TOT DE RECYCLING:

Het inpakmateriaal van dit product is recycleerbaar en kan opnieuw gebruikt worden. Er wordt verzocht om zich van elk afvalmateriaal te ontdoen volgens de plaatselijke voorschriften.

Volg voor het wegdoen van de speler de voorschriften voor de verwijdering van wit- en bruingoed op.

Batterijen mogen nooit worden weggegooid of verbrand, maar moeten volgens de plaatselijke voorschriften betreffende chemisch afval worden verwijderd.

Op dit product en de meegeleverde accessoires, m.u.v. de batterijen is de richtlijn voor afgedankte elektrische en elektronische apparaten (WEEE) van toepassing.

OBSERVERA ANGÅENDE ÅTERVINNING:

Produktens emballage är återvinningsbart och kan återanvändas. Kassera det enligt lokala återvinningsbestämmelser. När du kasserar enheten ska du göra det i överensstämmelse med lokala regler och bestämmelser.

Batterier får absolut inte kastas i soporna eller brännas. Kassera dem enligt lokala bestämmelser för kemiskt avfall.

Denna apparat och de tillbehör som levereras med den uppfyller gällande WEEE-direktiv, med undantag av batterierna.

UMA NOTA SOBRE A RECICLAGEM:

Os materiais de embalagem deste produto são recicláveis e podem ser reutilizados. Elimine quaisquer materiais de acordo com as normas de reciclagem locais.

Quando eliminar a unidade, obedeça às regras ou normas locais.

As pilhas nunca devem ser deitadas fora ou incineradas, mas sim eliminadas de acordo com as normas locais relativas aos resíduos químicos.

Este produto e os respectivos acessórios embalados em conjunto constituem o produto aplicável de acordo com a directiva WEEE, excepto as pilhas.



Pb

Getting started

Thank you for purchasing this DENON Professional product. To ensure proper operation, please read this owner's manual carefully before using the product. After reading, be sure to keep for future reference.

Contents

Getting started	1
Accessories	2
Main features	2
Cautions on handling	2
Discs	3
Discs playable on this unit	3
Holding discs	3
Loading discs	3
Cautions on loading discs	3
Cautions on storing discs	3
Cleaning discs	3
Part names and functions	4
Front panel	4
Rear panel	5
Remote control unit	6
Inserting the batteries	7
Operating range of the remote control unit	7
Display	8
Display during playback	8
Connections	11
Preparations	11
Cables used for audio connection	11
Audio connections	11
Analog connection (unbalanced connection)	11
Analog connection (balanced connection)	11
Digital connection (COAXIAL)	11
Digital connection (AES/EBU)	11
Connecting the external control terminal	12
Parallel port	12
RS-232C terminal	12
Connecting headphones	12
Connecting the power cord	12
Connecting media	13
Inserting and ejecting discs	13
Connecting a USB device or iPod	13
Cautions when using media	13
Setting Defaults	14
Menu List	14
Setting Defaults	15
Menu Operations (Preset Settings/System Settings)	15
Menu Operations (Utility)	18
File and folder settings	20
File List Menu	20
Select copy targets (Select)	20
Selecting all files for copying (Select All)	20
Copying files (Copy)	21
Track Information Display (Property)	21
Media List	22
Playback	23
Selecting the media to playback	23
Playback	23
End Monitor	23
Operations during playback	24
Track switching (◀◀, ▶▶)	24
Reserving the next track to play back (Next Track Reserve)	24
Fast forward and fast rewind (Search)	24
Jumping by frames (Frame jump)	24
A-B Repeat Playback (A-B Repeat)	25
Playback pitch adjustment (Pitch control)	25
Single playback or continuous playback (Single/Cont.)	26
Direct jump	26
Changing the output level	26
Rewind a specified amount of time and playback (Skip back)	26
Playback in the preferred order (Program playback)	26
Playing back from track hot points (Hot Start playback)	27
Registering a selected track to the Hot list	27
iPod playback	28
iPod playback	28
Control function	30
Various playback functions with RC-F400S	30
Part names and functions	30
Connection	32
Hot Start playback	33
Playback from the main screen	35
Other functions	36
Lock operating buttons (Key lock)	36
“DENON Professional Pitch Control” App for iPhone/iPod Touch	36
Serial remote control function	37
RS-232C control	37
Extended Communication Format (MIDI)	38
D&M RC Communication format (RC)	41
Parallel Control	43
Information	45
Error messages	45
RC-F400S error messages	45
Troubleshooting	46
Warranty	47
Main Specifications	48
Appendix	50

Accessories

Check that the following parts are supplied with the product.

① Quick start guide (Book)	1
② Owner's manual (CD-ROM)	1
③ Power cords for each region (US, EU).....	1 of each
④ Remote control unit (RC-1177).....	1
⑤ R03/AAA Batteries	2

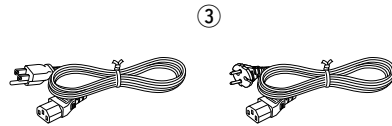

Main features

- CD media, USB device (mass storage class) and iPod®/iPhone® playback
- Large, easy to see organic electroluminescent (EL) display
- Balanced XLR connectors equipped for all outputs
- Supports pitch control of music on an iPod/iPhone using specialized software (DENON Professional Pitch Control)
- Pitch control playback allows adjustment of the playback speed between -16 % to +16 % in 0.1 % steps
- Master Key function allows for adjustment of the playback speed without changing the musical interval
- Supports remote control operation from parallel port and RS-232C

NOTE

The reproduction or use of materials such as music data or files may be restricted under the Copyright Act or other applicable laws, or under the terms of a license agreement between yourself and the material owner. Check that the conditions of use for all materials are thoroughly satisfied before reproduction etc., and use this equipment correctly. DENON Professional cannot accept any responsibility whatsoever for acts of copyright infringement undertaken by the user.

Cautions on handling

• Before turning the power switch on

- Check once again that all connections are correct and that there are no problems with the connection cables.
- Power is supplied to some of the circuitry even when the unit is set to the standby mode. When not using the machine for long periods of time, be sure to unplug the power cord from the power outlet.

• About condensation

If there is a major difference in temperature between the inside of the unit and the surroundings, condensation may form on parts inside the unit, causing the unit to fail to operate properly.

If this happens, let the unit sit for an hour or two with the power off and wait until there is little difference in temperature before using the unit.

• Cautions on using mobile phones

Using a mobile phone near this unit may result in noise. If that occurs, move the mobile phone away from the unit when it is in use.

• Moving the unit

Turn off the power and unplug the power cord from the power outlet. Next, disconnect the cables connected to other system units before moving the unit.

• Rack mount cautions (Required rack specifications for mounting the DN-501C on a rack)

- EIA Standard 19 inch rack
- 1U Size installation compatible rack
- Rack that has a guide rail or shelf board that can support this device

• Rack Installation

The DN-501C will work normally when the player unit is mounted within 10 degrees off the vertical plane at the front panel. If the unit is tilted excessively, the disc may not be loaded or unloaded properly.

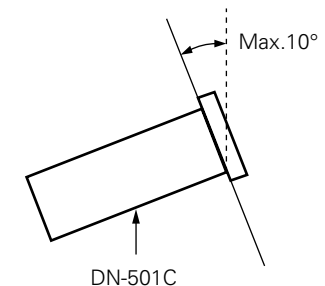

Discs playable on this unit

1 Music CDs

Discs marked with the logo at right can be played in this unit.



2 CD-R/CD-RW

NOTE

- Discs in special shapes (heartshaped discs, octagonal discs, etc.) cannot be played. Do not attempt to play them, as doing so can damage the unit.
- Some discs and some recording formats cannot be played.
- Non-finalized discs cannot be played.



* What is finalization?

Finalization is the process that makes recorded CD-R/CD-RW discs playable on compatible players.

Holding discs

Do not touch the signal surface.

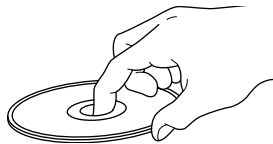

Loading discs

- Only load one disc at a time. Loading two or more discs can damage the unit or scratch the discs.
- When the disc is drawn into the unit, be careful not to trap your fingers.
- Do not insert anything other than discs into the disc loading slot.
- Do not use cracked or warped discs or discs that have been repaired with adhesive, etc.
- Do not use discs on which the sticky part of cellophane tape or labels is exposed or on which there are traces of where labels have been removed. Such discs can get caught inside the player and damage it.
- If the label side of the disc is dirty, wipe it clean before use. If the disc loading/ejection roller becomes dirty, discs may not load or eject correctly.

Cautions on loading discs

- Do not get fingerprints, oil or dirt on discs.
- Take special care not to scratch discs when removing them from their cases.
- Do not bend or heat discs.
- Do not enlarge the hole in the center.
- Do not write on the labeled (printed) surface with ball-point pens, pencils, etc., or stick new labels on discs.
- Water droplets may form on discs if they are moved suddenly from a cold place (outdoors for example) to a warm place, but do not try to dry them off using a hair-dryer, etc.

Cautions on storing discs

- Be sure to remove discs after using them.
- Be sure to store discs in their cases to protect them from dust, scratches, warping, etc.
- Do not store discs in the following places:
 - Places exposed to direct sunlight for long periods of time
 - Dusty or humid places
 - Places exposed to heat from heaters, etc.

Cleaning discs

- If there are fingerprints or dirt on a disc, wipe them off before using the disc. Fingerprints and dirt can impair sound quality and cause interruptions in playback.
- Use a commercially available disc cleaning set or a soft cloth to clean discs.

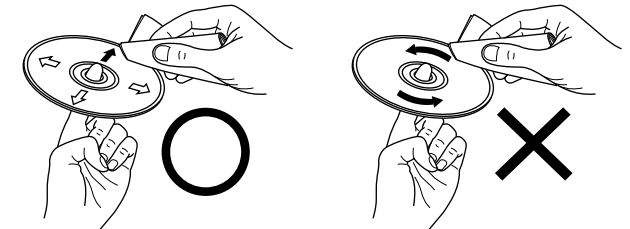

Gently wipe the disc from the inside towards the outside. Do not wipe in a circular motion.

NOTE

Do not use record spray, antistatic agents, benzene, thinner or other solvents.

Part names and functions

Front panel

For buttons not explained here, see the page indicated in parentheses ().

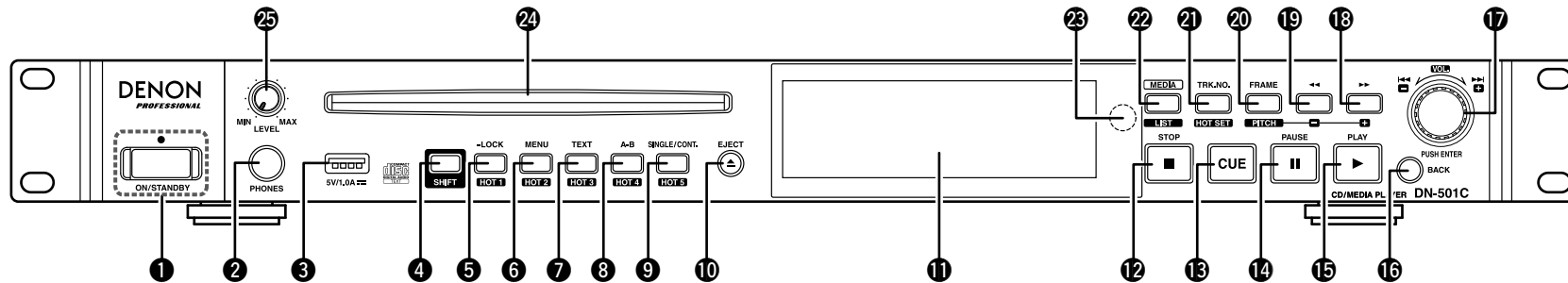

- 1 ON/STANDBY, Power indicator** (15, 23)
Turns the power on and off.
[Power indicator status]
Power on: Green
Standby: Red
- 2 Headphones jack (PHONES)** (12)
- 3 USB port** (13)
Connects to a USB device or iPod.
- 4 SHIFT button (SHIFT)** (15)
When the LED is lit, the function assigned to **SHIFT** is enabled.
- 5 LOCK/HOT 1 button** (27, 36)
Press and hold for more than 1 second to switch between all keys locked, specific button lock, and all keys unlocked.
 - Press while holding down **4 SHIFT** to play back from the location set to Hot Start #1. (Same applies for **6** to **9 HOT 2 to 5** buttons.)
 - When in Hot Set mode, the currently selected track is registered as Hot Start #1. (Same applies for **6** to **9 HOT 2 to 5** buttons.)

- 6 MENU/HOT 2 button** (14, 27)
Displays the main menu.
- 7 TEXT/HOT 3 button** (8, 27)
Scrolls the file name and text information on display.
- 8 A-B/HOT 4 button** (25, 27)
Sets A-B repeat playback.
- 9 SINGLE/CONT./HOT 5 button** (26, 27)
Switches the playback mode (SINGLE and CONTINUOUS).
- 10 EJECT button** (13)
- 11 Display** (8)
- 12 Stop/Cancel button (■)** (15, 20, 23, 24, 28)
- 13 CUE button** (23)
- 14 Pause button (||)** (23, 28)
- 15 Play button (▶)** (23, 28)

- 16 BACK button** (15, 20, 22, 28)
Returns to the previous operation.
- 17 Jog Dial/ PUSH ENTER button** (15, 20, 23, 24)
Moves between tracks. Also, after selecting a track, press the jog dial to play the selected track.
 - Rotate the jog dial while holding down **4 SHIFT** to adjust the output level.
 - Selects and enters items while the menu is displayed.
- 18 Fast Forward/Pitch + button (▶▶)** (24, 25)
- 19 Fast Rewind/Pitch - button (◀◀)** (24, 25)
- 20 FRAME/PITCH button** (24, 25)
Switches to frame search mode and starts Audible Pause.
 - Press while holding down the **4 SHIFT** button to switch the pitch on/off.

- 21 TRK NO./HOT SET button** (26, 27)
Selects tracks directly.
 - Press while holding down **4 SHIFT** to switch to HOT SET Mode and register the current track to Hot Start.
- 22 MEDIA/LIST button** (20, 22)
Switches between media.
 - Press while holding down **4 SHIFT** to display the file list.
- 23 Remote control signal receiver** (7)
- 24 Disc Slot** (13)
- 25 Headphone Volume Adjustment Knob (LEVEL)** (12)
Adjusts the volume of the headphones.
Press the knob to make it spring out.
After adjusting the volume, press the knob back in again.

Rear panel

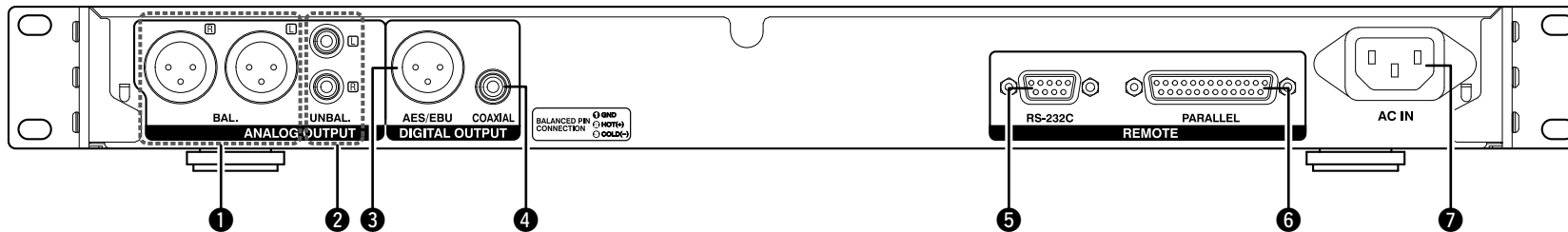

- 1 Analog output (balanced) terminal** (11)
 - Pin Arrangement: 1. GND/2. Hot/3. Cold
 - XLR Type
- 2 Analog output (unbalanced) terminal** (11)
 - RCA Type
- 3 Digital output (XLR) terminal** (11)
 - Pin Arrangement: 1. Common/2. Hot/3. Cold
 - Signal Format: IEC-60958 Type I (AES/EBU)
- 4 Digital output (RCA) terminal** (11)
 - Signal Format: IEC-60958 Type II (COAXIAL)
- 5 RS-232C Terminal** (12)
 - 9pin DSUB Connector (Female)
- 6 Parallel port (PARALLEL)** (12)
 - 25pin DSUB Connector (Female)
- 7 AC Inlet (AC IN)** (12)

Remote control unit

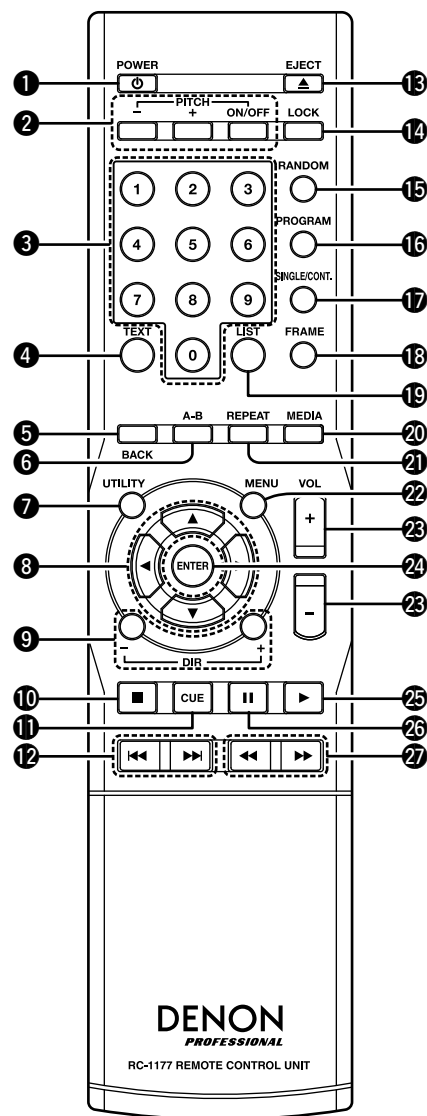

- 1 POWER button (⏻)**
Turns the power on and off.
- 2 PITCH button**
 - Turns the pitch control ON/OFF.
 - Changes the pitch adjustment value.
- 3 Number buttons (0 to 9)**
Selects tracks directly.
- 4 TEXT button**
Re-displays text information for tracks.
- 5 BACK button**
Returns to the previous menu.
- 6 A-B button**
Sets A-B repeat.
- 7 UTILITY button**
Displays the utility menu.
- 8 ARROW button**
Moves the cursor.
- 9 DIR +/- button**
Changes the directory (folder).
- 10 Stop button (■)**
Stops playback, or cancels the currently selected operation.
- 11 CUE button**
Returns to the cue point.
- 12 Track Skip button (⏮, ⏭)**
Moves tracks.
- 13 EJECT button**
Ejects the disc. Does not operate during playback.
- 14 LOCK button**
Locks all of the operations or specific buttons on the front panel of the unit.

- 15 RANDOM button**
Switches to random mode.
- 16 PROGRAM button**
Switches to program mode.
- 17 SINGLE/CONT. button**
Switches the playback mode (SINGLE/CONTINUOUS).
- 18 FRAME button**
Changes to frame search mode.
- 19 LIST button**
Displays the "File List".
- 20 MEDIA button**
Displays the "Media List".
- 21 REPEAT button**
Sets the repeat mode ON/OFF.
- 22 MENU button**
Displays the main menu.
- 23 VOL +/- button**
Adjusts the output level.
- 24 ENTER button**
Confirms the selected content.
- 25 Play button (▶)**
Starts playback.
- 26 Pause button (⏸)**
Pauses playback.
- 27 Search button (⏪, ⏩)**
Fast forwards or rewinds tracks.

Inserting the batteries

- ① Push the rear cover upwards in the direction of the arrows to remove it.
- ② Load the two batteries properly as indicated by the marks in the battery compartment.

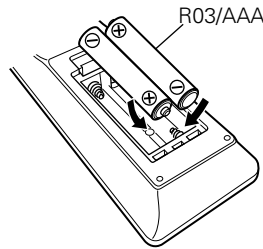
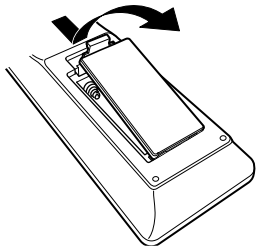

- ③ Put the rear cover back on.

NOTE

- Insert the specified batteries in the remote control unit.
- Replace the batteries with new ones if the set does not operate even when the remote control unit is operated close to the unit. (The supplied batteries are only for verifying operation. Replace them with new batteries at an early date.)
- When inserting the batteries, be sure to do so in the proper direction, following the ⊕ and ⊖ marks in the battery compartment.
- To prevent damage or leakage of battery fluid:
 - Do not use a new battery together with an old one.
 - Do not use two different types of batteries.
 - Do not attempt to charge dry batteries.
 - Do not short-circuit, disassemble, heat or dispose of batteries in flames.
 - Do not keep the battery in a place exposed to direct sunlight or in places with extremely high temperatures, such as near a heater.
- If the battery fluid should leak, carefully wipe the fluid off the inside of the battery compartment and insert new batteries.
- Remove the batteries from the remote control unit if it will not be in use for long periods.
- Used batteries should be disposed of in accordance with the local regulations regarding battery disposal.
- The remote control unit may function improperly if rechargeable batteries are used.

Operating range of the remote control unit

Point the remote control unit at the remote sensor when operating it.

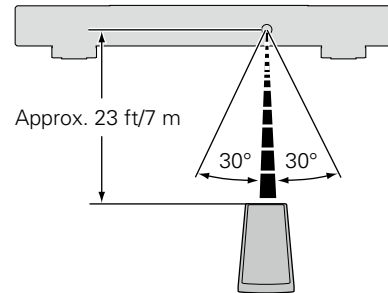

NOTE

- The set may function improperly or the remote control unit may not operate if the remote control sensor is exposed to direct sunlight, strong artificial light from an inverter type fluorescent lamp or infrared light.
- When using 3D video devices that transmit radio communication signals (such as infrared signals etc) between the various units (such as the monitor, 3D glasses, 3D transmitter unit etc), the remote control unit may not operate due to interference from those radio communication signals. If this occurs, adjust the direction and distance of the 3D communication for each unit, and check that the remote control unit operation is not affected by these signals.

Display

The playback status and information about various media is displayed on the DN-501C display.

Display during playback

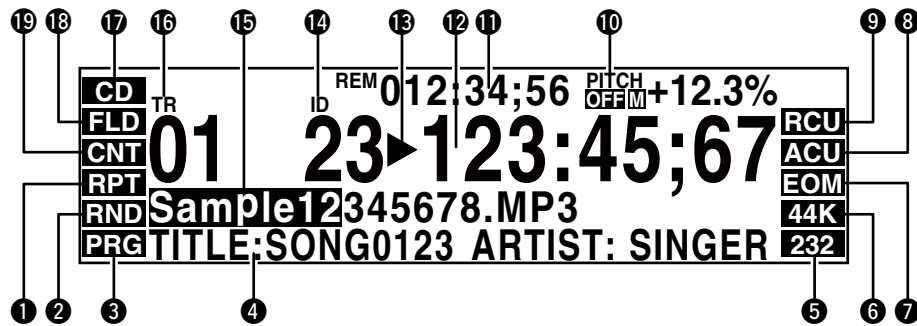

- 1 Repeat playback display**
"RPT" or "A-B" light during repeat playback.
- 2 Random playback display**
"RND" lights during random playback.
- 3 Programmed playback display**
"PRG" lights during programmed playback.
- 4 Text information display**
Displays text data (CD-TEXT/ID3 tags in MP3 data) included in the currently playing file.
 - Text that is too long to fit in the display is scrolled.
- 5 Remote serial connection display**
Lights when remote serial commands are being received.
 - The hold time is 0.5 seconds.
- 6 Sampling rate display**
Displays the sampling rate of the audio output. (44 K/48 K)
 - It is not displayed when "automatic" settings are used.
- 7 End Of Message display**
 - "EOM" lights when the End Of Message function is ON.
 - "EOM" flashes when playback is within the set time.
- 8 Auto cue display**
"ACU" lights when the auto cue function is ON.
- 9 Finish Mode display**
Displays the mode when the current track ends. ("NXT" when "Next" is set, "RCU" when "Recue" is set)

- 10 Pitch display**
Displays the ON/OFF status of the pitch function, master key and playback speed (percentage).

- 11 Remaining time display**
Displayed in the "mmm (minutes):ss (seconds):ff (frame)" format.
 - Minutes are displayed in two digits during CD playback.
 - The display changes to "--:--:--" during VBR file playback.

- 12 Elapsed time display**
Displayed in the "mmm (minutes):ss (seconds):ff (frame)" format.
 - The display stops at a maximum of 999:59:74.
 - Minutes are displayed in two digits during CD playback.

- 13 Status display**
 - Displays the operating status of devices.

STOP	■
CUE	CUE
PAUSE	
AUDIBLE PAUSE	
SEARCH	◀▶
PLAY	▶

- 14 Index number display**
Only displayed during CD playback.
- 15 File name display**
The name of the file currently being played is displayed along with the progress display bar.
 - File names that are too long to fit in the display are scrolled.
 - "TRACK XX" is displayed during CD playback.
- 16 Track number display**
 - When the "Next Trk Reserve" setting is On, flashes when there is a following track to be played.
 - Two digits are displayed for CD playback, and 4 digits are displayed for all other media.
 - "TR" lights during normal playback.
 - "HS" lights during hot start playback.
 - "PG" lights during programmed playback.
- 17 Media display**
Displays the currently selected media. ("CD"/"USB"/"iPod")
- 18 Playback range display**
Displays the current playback range. ("FLD": Current folder/"ALL": All folders)
- 19 Playback mode display**
Displays the current playback mode. ("CNT": Continuous/"SGL": 1 track)

Menu Screen

Press the **MENU** button to display the following screen.

01 File List
02 Program List
03 Hot List
04 Preset Setting
05 System Setting

- The Menu contains the following items.
 - File List
 - Program List
 - Hot List
 - Preset Setting
 - System Setting
 - Utility

File List

Displays folders and sound files.

1	Current Folder
2	< Up One Level >
3	Lower Folder
4	0001 BGM.MP3
5	<input checked="" type="checkbox"/> Music.WAV

- Folders are displayed first, followed by sound files.
 - 1 Displays the folder of the currently selected track.
 - The disc icon is displayed when CD is selected.
 - 2 Select to move up from the current folder hierarchy.
 - 3 Select to move down from the current folder hierarchy.
 - 4 Displays the first file in the current folder.
 - 5 Displays the currently selected file.

File List Menu

Press the jog dial when the "File List" is displayed to display this menu.

01 Set Current Track
02 Preview
03 Select
04 Select All
05 Copy

- The "File List Menu" contains the following items.
 - Set Current Track
 - Preview
 - Select
 - Select All
 - Copy
 - Property

Program List

Displays the files registered for programmed playback.

Program List
01 BGM01.MP3
02 BGM02.MP3
03 Music01.WAV
04 Music02.WAV

- The numbers on the left side indicate the programmed playback order.
- For CD-DA, <TRACK-XX> (XX=Track No.) is displayed in the file name display.

Program List Menu

Press the jog dial when the "Program List" is displayed to display this menu.

01 Preview
02 Insert
03 Remove
04 Remove All
05 Load

- The "Program List Menu" contains the following items.
 - Preview
 - Insert
 - Remove
 - Remove All
 - Load (Only for USB media)
 - Save (Only for USB media)

Hot List

Displays the files registered for "Hot Start".

Hot List
01 BGM01.MP3
02 BGM02.MP3
03 Music01.WAV
04 Music02.WAV

- The number on the left side indicates the Hot Start number.
- For CD-DA, <TRACK-XX> (XX=Track No.) is displayed in the file name display.
- Unregistered Hot Start are displayed as <Empty>.

Hot List Menu

Press the jog dial when the "Hot List" is displayed to display this menu.

01	Preview
02	Auto Mapping
03	Set
04	Remove
05	Remove All

- Screen used for editing "Hot Start" assignments.
- The "Hot List Menu" contains the following items.
 - Preview
 - Auto Mapping
 - Set
 - Remove
 - Remove All
 - Load (Only for USB media)
 - Save (Only for USB media)

Misc List

Select the "Load" or "Save" menu when the "Hot List Menu" or "Program List Menu" is displayed to display this menu. The "Playlist" file and "Hot Start" file can be confirmed.

1	Current Folder
2	< Up One Level >
3	Lower Folder
4	0001 BGM.M3U
5	0002 Music.M3U

- 1 Displays the name of the currently selected folder.
- 2 Select to move up from the current folder hierarchy.
- 3 Select to move down from the current folder hierarchy.
- 4, 5 Display the "Misc List" files in the current folder.



- xxx.m3u The file containing setting information for program playback.
- xxx.ppl The file containing setting information for hotstart playback.

Preset Setting

Sets the operating status of the unit.

01	Shift Mode	Momentary
02	Power On	Resume Play
03	Play Range	All
04	Play mode	Continuous
05	Random	Off

For details on "Preset Setting", see "Preset Setting" (page 15).

System Setting

Sets the initial status of the unit.

01	Mono	Off
02	Output rate	Auto
03	Auto Sleep	Off
04	Volume Output	Variable
05	Ref(XLR/RCA)	+24dBu/+10dBV

For details on "System Setting", see "System Setting" (page 17).

Utility

Displays the utility menu.

01	Load Setting
02	Save Setting
03	Firmware Version
04	Format Media

- "Utility" contains the following items.
 - Load Setting
 - Save Setting
 - Firmware Version
 - Format Media

Media List

Select the media to play back. Press the **MEDIA** button to display the following screen.

Media List	
	CD
	USB(None)
	iPod/iPhone

- The "Media List" contains the following items.
 - CD
 - USB
 - iPod/iPhone



- "(None)" is displayed after the media name for media that is not ready to playback.

Connections







NOTE

- Do not plug in the power cord until all connections have been completed.
- When making connections, also refer to the operating instructions of the other components.
- Insert the plugs securely. Loose connections will result in the generation of noise.
- Be sure to connect the left and right channels properly (left with left, right with right).
- Connect the output correctly.
- Do not bundle power cords together with connection cables. Doing so can result in humming or noise.

Preparations

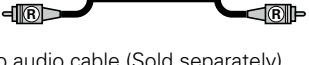
Cables used for audio connection

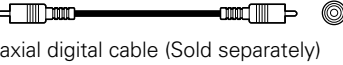
Select the cables according to the equipment being connected.

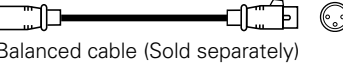
Audio cables	
Analog Connection (RCA)	
(White) 	
(Red) 	
Stereo audio cable (Sold separately)	
Digital Connection (RCA)	
	
Coaxial digital cable (Sold separately)	
Analog Connection (XLR), Digital Connection (XLR)	
	
Balanced cable (Sold separately)	

Audio connections

Analog connection (unbalanced connection)

Connect a line level analog cable to the analog output (unbalanced) terminal.

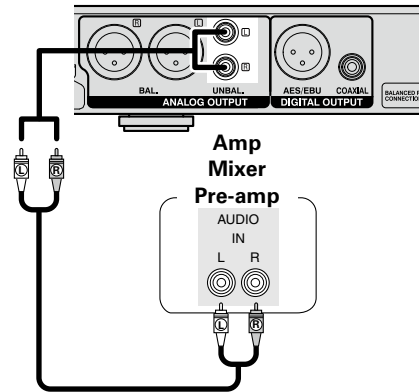

Analog connection (balanced connection)

Connect the analog output (balanced) terminal to a line level analog input.

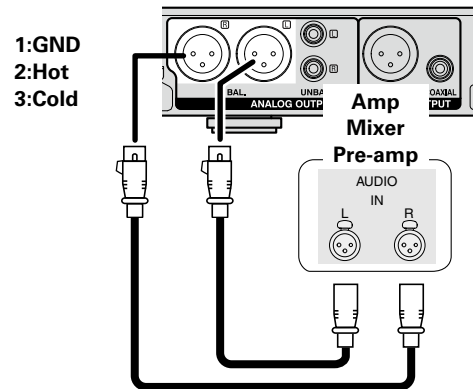

Digital connection (COAXIAL)

Connect the COAXIAL digital output terminal to a digital input terminal.

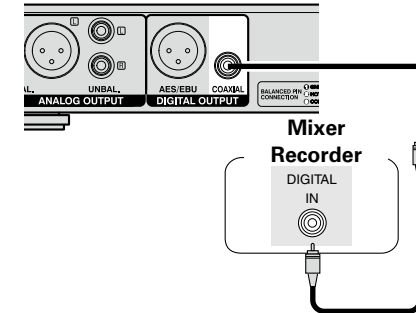

Digital connection (AES/EBU)

Connect the AES/EBU digital output terminal to a digital input terminal.

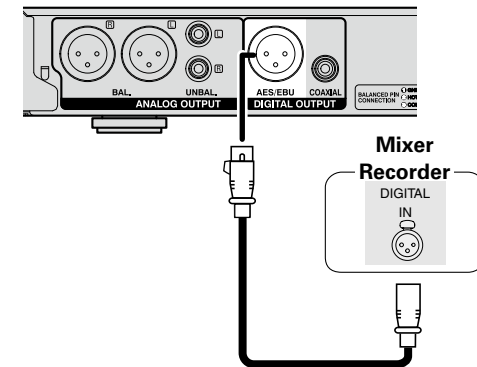

Connecting the external control terminal

Parallel port

Connect an external device to the parallel port.

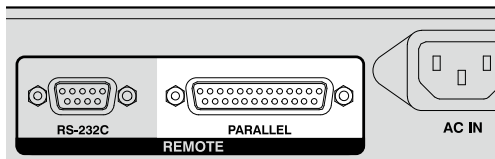

Parallel control can be used to control DN-501C from an external device.

For details on parallel control, see "Parallel Control" (page 43).

RS-232C terminal

Connect an RS-232C straight cable with a 9-pin D-sub connector to the RS-232C serial terminal.

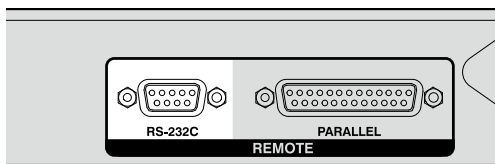

RS-232C control can be used for external control of the host device and to configure settings.

For details on RS-232C control, see "RS-232C control" (page 37).

Connecting headphones

Connect the headphones to the headphone jack (PHONES).

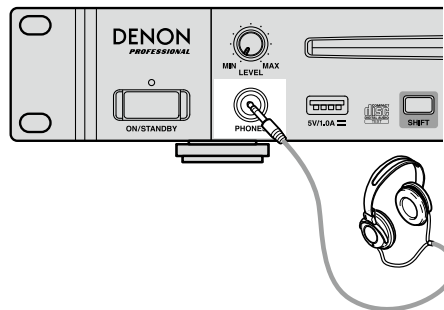

When you press the headphone volume adjustment knob (**LEVEL**), the knob will spring out. After adjusting the volume, press the knob back in again.

NOTE

To prevent hearing loss, do not raise the volume level excessively when using headphones.

Connecting the power cord

Insert the power cord when all other connections are completed. Be sure to connect the ground wire also.

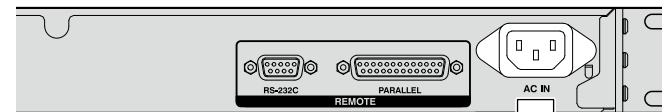

To the power socket
(AC 120 V, 60 Hz)

U.S.A. and Canada models

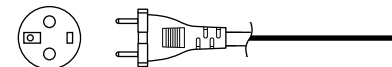

To the power socket
(AC 230 V, 50/60 Hz)

European, UK and Asia/Pacific models

NOTE

- Be sure to insert the power plug firmly into the AC outlet. If the plug is not properly inserted, it could cause malfunction or noise.
- Do not unplug the power cord while the unit is operating.
- Do not use a power cord other than the cord supplied with this unit.

Connecting media

Inserting and ejecting discs

This operation is done when the power is switched on.

1 Press **ON/STANDBY** to turn the power on.

2 Hold the edges of the disc, and insert the disc into the disc slot.

- Do not touch the recorded surface (shiny surface) with your hands.

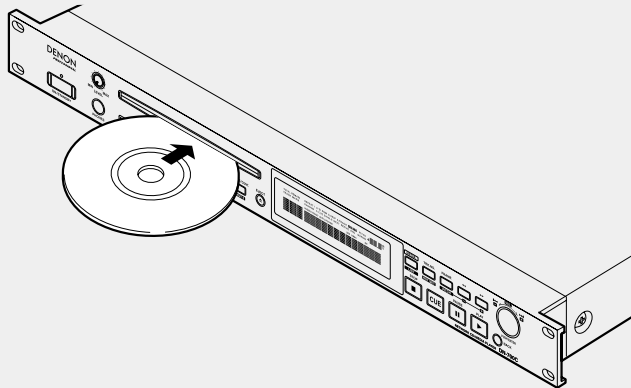

3 Press **EJECT** and remove the disc.

Messages

The DN-501C displays various messages during use. The message contents are explained below.

Message	Content
No Disc	The disc slot is empty.
Eject Locked	Ejection of the disc that is currently being played is locked. Playback needs to be stopped for the disc to be ejected."

NOTE

Do not attempt to push a disc in by hand when the power is off. Doing so may damage the CD player or cause a malfunction.

Connecting a USB device or iPod

DN-501C supports external USB devices (mass storage class).

- A USB hub is not supported.
- FAT16/FAT32/HFS+ (read only) file systems are supported.

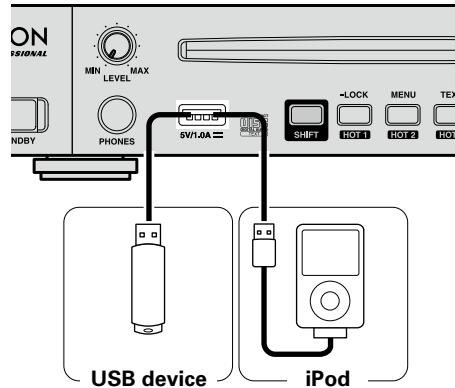

NOTE

- Do not remove the USB device during USB playback. Forcibly removing the USB device during USB playback may damage the data on the USB memory or hard disk.
- Do not use an extension cable to connect the USB device.

Cautions when using media

- Do not use a cracked or warped CD or USB drive, or one that has been repaired with adhesive.
- "Loading..." appears on the display when media is used or loaded. Do not remove the media while this message is displayed.

Setting Defaults

Menu List

Setting Item			Page
File List	(Normal)	File List Menu	Set Current Track
			Preview
			Select
			Select All
			Copy* ¹
			Property
(Set/Insert)	File List Menu	Preview	
		Execute	
Program List	Program List Menu	Preview	
		Insert* ¹	
		Remove	
		Remove All	
		Load* ²	
		Save* ²	
Hot List	Hot List Menu	Preview	
		Auto Mapping	
		Set* ¹	
		Remove	
		Remove All	
		Load* ²	
Preset Setting	Shift Mode	15	
	Power On	15	
	Play Range	15	
	Play Mode	15	
	Random	15	
	Program	15	
	Finish Mode	15	
	Repeat	15	
	Auto Cue	15	
	Skip Back	16	
	Search Mode	16	
	Auto Fade In	16	
	Auto Fade Out	16	
	Start Delay	16	
	End Of Message	16	

Setting Item		Page
Preset Setting	Next Trk Reserve	16
	Master Key	16
	End Monitor	16
	Dimmer	16
	Display Dimmer	16
	LED Dimmer	16
	Screen Saver	16
	Remain Time Mode	16
	Fader Start	16
	Para Rem Mode	16
System Setting	Default	16
	Mono	17
	Output Rate	17
	Auto Sleep	17
	Volume Output	17
	Ref (XLR/RCA)	17
	Trim L	17
	Trim R	17
	Display Contrast	17
	IR Remote	17
Utility	Serial Bit Rate	17
	Serial Protocol	17
	Password* ³	17
	Default	17
	Load Setting	10
	Save Setting	
	Firmware Version	
Format Media		

*1 Press the **ENTER** button to enter the "File List".

*2 Press the **ENTER** button to enter the "Misc List".

*3 Press the **ENTER** button to enter the "Text Editor".

Setting Defaults

Menu Operations (Preset Settings/System Settings)

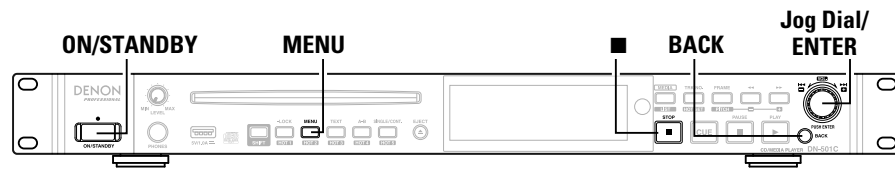

- 1 Press ON/STANDBY.**
The power of DN-501C is switched ON, and the display screen lights.
- 2 While DN-501C is stopped or in cue, press MENU.**
The menu list is displayed.
 - For details on the setting items in each menu, see “Menu List” (page 14).
- 3 Rotate the jog dial to select the setting item that you want to change, and press the jog dial.**
The menu list of the selected item is displayed.
- 4 Select the setting item that you want to change, and press the jog dial.**
The setting item is chosen.
 - To continue to set other items, perform the operation in step 3 again.
 - To return to the upper level menu from the menu item currently being set, press **BACK**.
- 5 After you finish all settings, press MENU.**
The changed settings are saved, and DN-501C returns to the stopped status.



To cancel the settings, press **■**.

Saving menu settings to USB memory

The DN-501C has a function for saving menu settings to USB media. This function is useful for sharing the same settings from one DN-501C on multiple DN-501C units.

For details on the operations, see the separate “Save Setting” (page 18).

Preset Setting

Item	Setting Details (Items in bold are factory default)
Shift Mode Sets operations for the SHIFT button.	Momentary: Shift mode can be operated while pressing and holding the SHIFT button. Lock: Shift mode will hold when the SHIFT button is pressed and released. The SHIFT button will light when in Shift mode.
Power On Sets the operation when the DN-501C power is switched on.	Stop: A track is not played back when the power is switched on. Resume Play: Start playback from the track that was played last by the previous operation. Play First: Start playback at track #1 of the last folder or disc that you played back during the previous operation.
NOTE	
If the media that was previously being played back is removed while the unit power is off, when the power is turned on again CD is selected in the stopped status.	
Play Range Sets the track playback range.	All: Plays back all of the tracks in all folders. Folder: Plays back all of the tracks in the selected folder.
Play Mode Sets the track playback mode.	Continuous: Plays back all tracks within the “Play Range” setting continually. Single: Plays back only 1 track.
Random Sets random playback.	On: Plays back tracks at random. Off: Random playback is not performed.
Program Sets programmed playback.	On: Plays back tracks in the set order (programmed playback). Off: Programmed playback is not performed.
Finish Mode Sets the operation when playback is stopped.	Stop: Playback is stopped at the start of the folder or disc. Next: When playback is stopped, the start of the following track is cued. Recue: Playback stops and returns to the cue point.
Repeat Sets repeat playback.	On: Performs repeat playback according to the “Play Mode” settings. Off: Repeat playback is not performed.
Auto Cue	Off: Does not function. –48 dB: After a track has been selected, playback is cued at the point where the volume level is less than –48 dB. –42 dB: After a track has been selected, playback is cued at the point where the volume level is less than –42 dB. –36 dB: After a track has been selected, playback is cued at the point where the volume level is less than –36 dB.

Item	Setting Details (Items in bold are factory default)
Skip Back	0.5 to 2 to 60 sec: Set the skip back time for a track that is currently being played back to 0.5 second intervals between 0.5 and 10 seconds, or 5 second intervals between 10 and 60 seconds.
Search Mode Sets the search mode.	Normal: Plays back audio in 2 x speed search, but does not play back audio at faster playback speeds. Silent: Audio is not played back during search.
Auto Fade In Sets fade in.	Off: Does not function. 0.5 sec: Sets the volume to gradually increase within 0.5 seconds. 1.0 sec: Sets the volume to gradually increase within 1 seconds. 3.0 sec: Sets the volume to gradually increase within 3 seconds.
Auto Fade Out Sets fade out.	Off: Does not function. 0.5 sec: Sets the volume to gradually decrease within 0.5 seconds. 1.0 sec: Sets the volume to gradually decrease within 1 seconds. 3.0 sec: Sets the volume to gradually decrease within 3 seconds.
Start Delay Sets the playback start timing.	Off: Does not function. (Playback starts immediately). 100 ms: Playback starts after a 0.1 second gap. 200 ms: Playback starts after a 0.2 second gap. 300 ms: Playback starts after a 0.3 second gap.
End Of Message Sets how the EOM display lights in the display.	Off: Does not function. 0 sec: EOM display flashes for 0.5 seconds after the track finishes. 5 sec: EOM display flashes from 5 seconds before the track finishes. 10 sec: EOM display flashes from 10 seconds before the track finishes. 15 sec: EOM display flashes from 15 seconds before the track finishes. 20 sec: EOM display flashes from 20 seconds before the track finishes. 30 sec: EOM display flashes from 30 seconds before the track finishes. 60 sec: EOM display flashes from 60 seconds before the track finishes.
Next Trk Reserve Reserving the next track to playback during playback.	Off: Playback of the selected track starts immediately. On: When the track is selected, when currently track is stopped playback or ENTER button is pressed, then playback the selected track (reserved track).
Master Key	Off: Disables the tone control for the pitch control function. On: Enables the tone control for the pitch control function.
End Monitor Plays the specified amount of time at the end of a track.	Off: Does not function. 5sec: Playback starts from 5 seconds before the end of the track. 10sec: Playback starts from 10 seconds before the end of the track. 15sec: Playback starts from 15 seconds before the end of the track. 20sec: Playback starts from 20 seconds before the end of the track. 25sec: Playback starts from 25 seconds before the end of the track. 30sec: Playback starts from 30 seconds before the end of the track. 35sec: Playback starts from 35 seconds before the end of the track.

Item	Setting Details (Items in bold are factory default)
Dimmer Enables/disables the "Display Dimmer" and "LED Dimmer" settings.	Off: Disables the "Dimmer" settings. On: Enables the "Display Dimmer" and "LED Dimmer" settings.
Display Dimmer Sets the brightness of the display. (Enabled when the "Dimmer" setting is On.)	100 %: Normal brightness. 75 %: 75 % of the normal brightness. 50 %: 50 % of the normal brightness. 25 %: 25 % of the normal brightness. 0 %: Off in the standby status, and 25 % of the normal brightness during operation.
LED Dimmer Sets the LED brightness. (Enabled when the "Dimmer" setting is On.)	100 %: Normal brightness. 75 %: 75 % of the normal brightness. 50 %: 50 % of the normal brightness. 25 %: 25 % of the normal brightness.
Screen Saver Sets the screen saver operation.	Off: Does not function. On: The screen saver starts when there are no operations for 30 minutes.
Remain Time Mode Sets the remaining time display.	Track: Displays the remaining time for each track. Total: Displays the remaining time for all playback target tracks (CDDA only).
Fader Start Sets the operations when parallel remote is used.	Play: Plays back while the FADER START pin of the parallel remote is closed. Play-Pause: Plays back while the FADER START pin is closed, and pauses when this pin is opened. Play-Next: Plays back while the FADER START pin is closed, and jumps to the next track when this pin is opened. Play&Lock: Plays back while the FADER START pin is closed, and locks the keys of the unit. Play&Lock-Pause: Plays back when the FADER START pin closes, and locks the keys of the unit. Playback pauses when this pin opens. Play&Lock-Next: Plays back when the FADER START pin closes, and locks the keys of the unit. Playback jumps to the next track when this pin opens.
Para Rem Mode Sets the operation when Hot Start playback.	Hot Start: Sets the Hot Start mode. Hot Cue: Sets the Hot Cue mode (Playback is not performed by Hot Start).
Default	Resets all of the preset settings to the defaults.

□ System Setting

Item	Setting Details (Items in bold are factory default)
Mono	Off: Channel output based on the audio source. On: Summed monaural output.
Output Rate Sets the sampling frequency for digital output.	Auto: Audio output based on the rate of the input media or file. 44.1 k: Audio output at 44.1 kHz. 48 k: Audio output at 48 kHz.
Auto Sleep Sets the time that rotation of the disc stop.	Off: Does not function. 30 sec: Switches to sleep mode if there are no operations for 30 seconds. 10 min: Switches to sleep mode if there are no operations for 10 minutes. 20 min: Switches to sleep mode if there are no operations for 20 minutes. 30 min: Switches to sleep mode if there are no operations for 30 minutes.
Volume Output	Fixed (0dB): Prohibits the output level from being adjusted and fixes it as 0dB. Variable: Output level can be adjusted. For details on the operations, see the separate "Changing the output level" (page 26).
Ref (XLR/RCA) Output level of the analog output can be changed.	+24 dBu/+10 dBV: XLR=+24 dBu / RCA=+10 dBV +20 dBu/+6 dBV: XLR=+20 dBu / RCA=+6 dBV +18 dBu/+4 dBV: XLR=+18 dBu / RCA=+4 dBV +6 dBV/+6 dBV: XLR=+6 dBV / RCA=+6 dBV
Trim L	+2.0 dB - 0 - -2.0 dB: Adjusts the left channel in 0.1 dB steps. Initial value is " 0 dB ".
Trim R	+2.0 dB - 0 - -2.0 dB: Adjusts the right channel in 0.1 dB steps. Initial value is " 0 dB ".
Display Contrast	1 - 5 : 1 is the darkest, 5 is the brightest. Initial value is " 5 ".
IR Remote	On: Receives IR remote commands. Off: Does not receive IR remote commands.
Serial Bit Rate Sets the RS-232C bit rate.	9600: 9600 bps 38400: 38400 bps
Serial Protocol	MIDI: Conforms to MIDI controls. RC: Conforms to D&M RC protocol.
Password	****: Sets a password (6 to 12 characters) for system settings. Displayed as "****" when set. Default value is "No password (NULL)".
Default	Resets all of the system settings to the defaults.

Menu Operations (Utility)

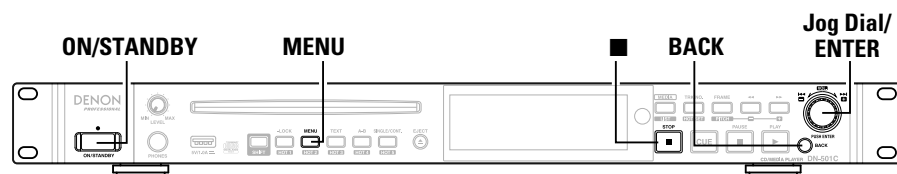

❑ Load Setting

Reads the setting file stored in the root of the USB media device and changes the DN-501C's settings

- 1 Press ON/STANDBY.**
The power of DN-501C is switched ON, and the display screen lights.
- 2 While DN-501C is stopped, press MENU.**
The menu list is displayed.
- 3 Rotate the jog dial to select "06 Utility", and press the jog dial.**
- 4 Rotate the jog dial to select "01 Load Setting", and press the jog dial.**
A pop up is displayed.
- 5 Select "OK" and press the jog dial.**
The file (DN-501C.ini) saved in the USB media device is read, and the DN-501C settings are changed.

❑ Save Setting

The current settings are saved to the root of the USB media device

- 1 Press ON/STANDBY.**
The power of DN-501C is switched ON, and the display screen lights.
- 2 While DN-501C is stopped, press MENU.**
The menu list is displayed.
- 3 Rotate the jog dial to select "06 Utility", and press the jog dial.**
- 4 Rotate the jog dial to select "02 Save setting", and press the jog dial.**
A pop up is displayed.
- 5 Select "OK" and press the jog dial.**
The file (DN-501C.ini) is written to the root of the USB memory stick.

❑ Firmware Version

Displays the firmware version of the DN-501C.

- 1 Press ON/STANDBY.**
The power of DN-501C is switched ON, and the display screen lights.
- 2 While DN-501C is stopped, press MENU.**
The menu list is displayed.
- 3 Rotate the jog dial to select "06 Utility", and press the jog dial.**
- 4 Rotate the jog dial to select "03 Firmware Version", and press the jog dial.**
Displays the firmware version of the DN-501C.
 - Press either the **Back** or **STOP** button to return.

Format Media

1 Press ON/STANDBY.
The power of DN-501C is switched ON, and the display screen lights.

2 While DN-501C is stopped, press MENU.
The menu list is displayed.

3 Rotate the jog dial to select “06 Utility”, and press the jog dial.

4 Rotate the jog dial to select “04 Format Media”, and press the jog dial.
A pop up message is displayed.

5 Select “OK” and press the jog dial.
The media is formatted.

- Press either the **Back** or **STOP** button and selected Cancel to return.

File and folder settings

File List Menu

You can select files and check file information.

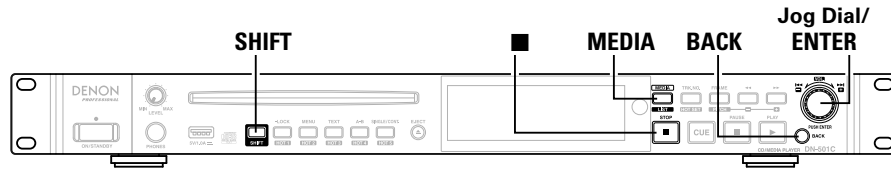

□ Displaying the File List Menu

- 1 Press **MEDIA** while holding down **SHIFT**, or select “File List” from the menu screen when in stop or cue mode.

Displays the “File List”.

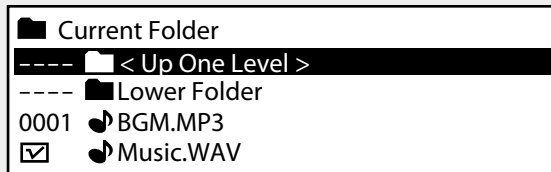

- 2 Select the file that you want to operate, and press the jog dial.

The “File List Menu” is displayed.

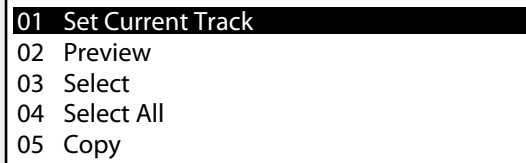

- Press **BACK** when the “File List Menu” is displayed to return to the previous screen.

□ File List Menu List

Display	Explanation
Set Current Track	Prepares to playback the selected track.
Preview	Preview the selected Track
Select	Selects the file.
Select All	Selects all files in the list.
Copy	Copies selected files.
Property	Displays information of the selected track.

Select copy targets (Select)

This is used when you want to select multiple items to copy.

Select “Select” and press the jog dial.

Close the file menu and return to the file list. The file under the cursor is selected and a check mark is added to the front of the file name.

- If the file is in the selected state, it changes to unselected.



The selected state is cleared when the folder is changed.

Selecting all files for copying (Select All)

This function is used to select all files to be copied. Select or unselect all of the files in the displayed file list.

Select “Select All” and press the jog dial.

The display returns to the “File List”. All of the files are selected and a check mark is added to the front of the file name.

- If all files were in the selected state, they change to unselected.



The selected state is cleared when the folder is changed.

Copying files (Copy)

Files selected with “Select” or “Select All” are copied.

- If the selected copy source is CD-DA, WAV files are created in the copy destination (ripping function).

1 Select “Copy” and press the jog dial.

The “Media List” is displayed.

2 Locate the copy destination folder using the jog dial.

3 Select the copy destination folder and press the jog dial.

- Media that cannot be written to (including iPod, CD) cannot be selected.

4 Select “Copy Here” and press the jog dial.

Copying of the selected track starts.

- During copying, a pop up screen shows the copying progress as a percentage.
- Press the jog dial during copying to cancel the process.
 - Files that have already been copied are not deleted.
- When copying is completed, “Completed” appears in the display.

Track Information Display (Property)

Displays information of the currently selected track.

Media List

Media that can be selected are displayed in a list.

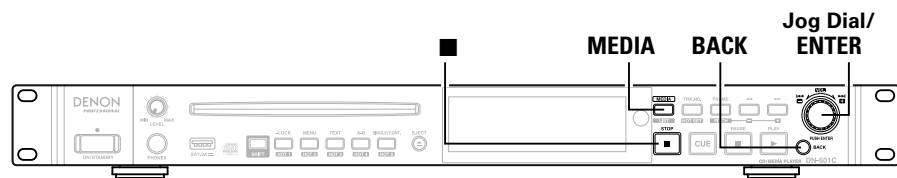

□ Displaying the media list

- 1** While DN-501C is stopped or in cue, press **MEDIA**.
The media list is displayed.

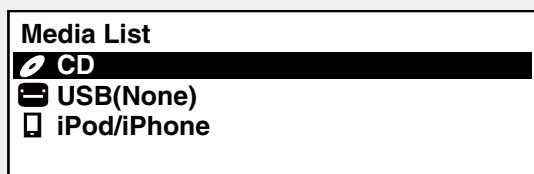

- Press **BACK** when the media list is displayed to return to the previous screen.
- “(None)” is displayed after the media name for media that is not ready to playback.

- 2** Select the media to change using the jog dial.

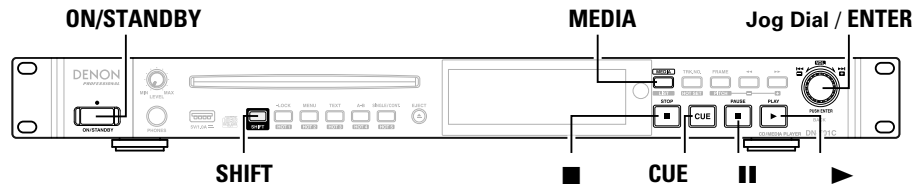

Selecting the media to playback

- 1 Press ON/STANDBY.**
The power of DN-501C is switched ON, and the display screen lights.
- 2 While DN-501C is stopped or in cue, press MEDIA.**
The media list is displayed.

Media List

- CD
- USB(None)
- iPod/iPhone

- For details on the media list display contents, see “Displaying the media list” (page 22).

- 3 Rotate the jog dial to select the media that you want to play back, and press the jog dial.**
• To change the playback folder, press the **LIST** button on the remote control or select “File List” in the menu (page 20).

Playback

- Rotate the jog dial to select the file that you want to playback, and press ►.**
► lights and playback starts.

End Monitor

- In the cued state, press the jog dial while holding down SHIFT.**
- The end of the track is played back for the amount of time set in “End Monitor” in Preset.
 - When playback has completed, playback recues to the previous cue point.

To stop playback

- Press ■.
- Playback stops, ► goes out and **CUE** lights.
 - The playback position is moved to the playback start position set for “Finish Mode” in the preset menu, and playback stops.
 - The stop position can be changed in the “Finish Mode” settings as shown below.

When Stop is set: Playback is stopped at the start of the folder or disc.

When Next is set: Playback is stopped at the beginning of the next file.

When Recue is set: Playback is stopped at the point where playback was previously started.

To pause playback

- Press || during playback.
- Playback is paused, and || lights.
 - Press ► again to restart playback.

To return to the playback start position

- Press **CUE** during playback.
- Playback switches to cue standby at the playback start position.

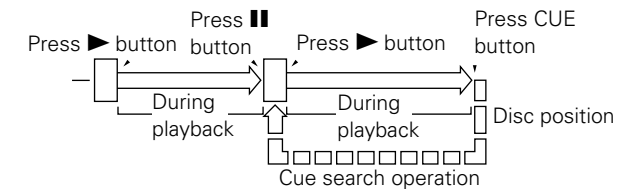
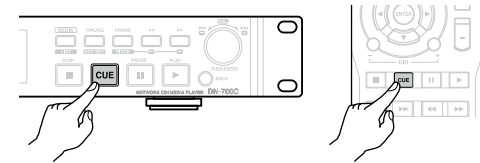

Operations during playback

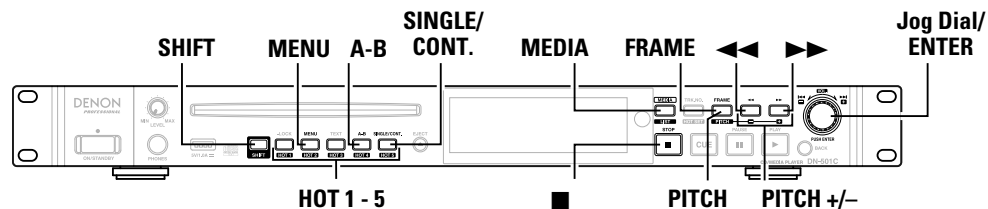

Track switching (|◀◀, ▶▶|)

Rotate the jog dial during playback, cue, or while stopped.

- Rotate in the clockwise direction to switch to the next track.
- Rotate in the counterclockwise direction to switch to the start of the current track or previous tracks.

Reserving the next track to play back (Next Track Reserve)

When the “Next Trk Reserve” setting is on, the next track to be played back can be reserved.

Rotate the jog dial during playback.

- The track number display flashes, and the next track to be played back can be selected.
- Press the **BACK** button to cancel the playback reservation.

Fast forward and fast rewind (Search)

Press ◀◀ or ▶▶ during playback.

- Press ◀◀ for fast rewind playback.
- Press ▶▶ for fast forward playback.
- The operation switches as shown below depending on how many times the button is pressed.

No. of times button is pressed	Music file	CD-DA Track
Once	×2	×2
Twice	×10	×5
3 times	×50	×10
4 times	×100	×20
5 times	×200	×50



- Sound is not output at speeds above 2x.
- When fast forward search is used to the end of the last file, or when fast rewind search is used to the start of the first file, the file pauses.

NOTE

- Search cannot be performed on files that are recorded using VBR.
- If a VBR file is found during the search process, the search ends at the VBR file.
- No operations including search can be performed for 0.2 seconds from the start of Hot Start playback.

Jumping by frames (Frame jump)

1 Press FRAME.

- Press **FRAME** during playback, cue or pause to switch to the Audible Pause state.

2 Press ◀◀ or ▶▶ during Audible Pause.

- Press ◀◀ to move 1 frame in the reverse direction.
- Press ▶▶ to move 1 frame in the forward direction.



1 frame is 1/75 seconds.

A-B Repeat Playback (A-B Repeat)

Repeat playback is performed between the set A and B point during playback.

- 1 Press A-B during playback.**
Set the repeat start point (A point).
- 2 Press A-B to set the repeat end point.**
Set the repeat end point (B point), and repeat playback continues between A and B points.
- 3 Press A-B again to exit repeat playback.**

- Return to the start position of a track during playback**

Rotate the jog dial counterclockwise during playback.

Playback returns to the track start position, and playback starts again.



Rotating the jog dial within 1 second of the beginning of the track moves back to the previous track.

Playback pitch adjustment (Pitch control)

The playback speed can be adjusted within a range of -16 % to +16 %.

By adjusting the pitch, you can listen to recordings over a shorter time span, or listen more slowly.

- 1 Press PITCH while holding down SHIFT during playback, cue or when stopped.**
A pop up is displayed and the pitch adjustment is enabled.

- 2 Press PITCH + or PITCH - while holding down SHIFT.**

- The pitch changes by 0.1 % each time the button is pressed.
- Press and hold the button to change the pitch continuously.
- To cancel the pitch control, press **PITCH** again while holding down the **SHIFT** button.
- Hold down the **SHIFT** button and pressed **PITCH+** and **PITCH-** button, reset the pitch value.

- Changing the playback speed without changing the musical interval (Master Key)**

When the playback speed is adjusted using the pitch control, the musical interval changes according to the playback speed. With the Master Key function on, you can play back music without changing the musical interval even when you change the pitch.

- The Master Key setting is performed in “Master Key” (page 16) in the preset menu.
- If “Master Key” in the menu is set to “On”, the master key mark appears in the display when the pitch is adjusted.

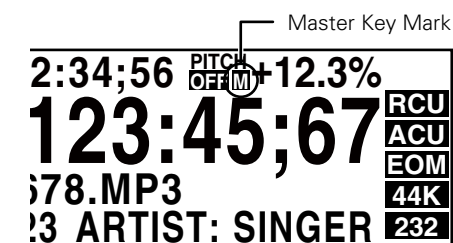

Single playback or continuous playback (Single/Cont.)

Select whether to playback one track or to playback continuously.

Press **SINGLE/CONT.** during playback, cue, or while stopped.

The icon on the screen changes.

CNT: Continuous playback

SGL: Single track playback

Direct jump

[Operations on the Unit]

1 Press **TRK NO.**
A pop up is displayed.

2 Rotate the jog dial to select a track number.
In 1 second, playback moves to the selected track.

- To select a number from the 10th and subsequent tracks, select the first digit -> press the jog dial -> select the second digit.

[Operations on the remote control]

While stopped or in cue, press the number buttons on the remote control (0 to 9) to jump directly to the track you want to hear.

To select the 10th and subsequent tracks, push the number buttons in the order of 10 digit -> 1 digit.

E.g. Playing back track 12

- ① Press the number button 1.
- ② Press the number button 2 within one second.

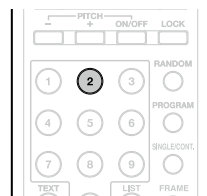
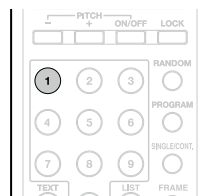

Changing the output level

Changes the output level of both analog and digital outputs (☞ page 17 "Volume Output").

[Operations on the Unit]

Hold down the **SHIFT** button and rotate the jog dial.

[Operations on the remote control]

Press the **VOL +** or **-** button.

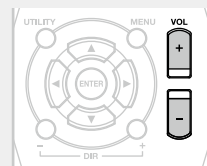

Rewind a specified amount of time and playback (Skip back)

The track is rewound for the set amount of time from the current playback position during playback or pause from an operation on an external remote (parallel, RS-232C).

The skip back time setting is set in "Skip Back" in the "Preset Settings" (☞ page 15).

[Parallel Control]

When the parallel input normal mode is set, press the **skip back switch on the connected device.**

For details, see "Parallel Control" (☞ page 43).

[RS-232C Control]

Send a **skip back command.**

For details, refer to "RS-232C control" (☞ page 37)

Playback in the preferred order (Program playback)

1 Select "**Program List**" from the menu.
"Program List" is displayed.

- Files are not displayed if no program has been set.

2 Press the **jog dial.**
The "Program List Menu" is displayed.

3 Select "**Insert**" and select the file you want to program.
The "File List" is displayed.

4 Select "**Execute**" and register files to the "Program List".

5 Press **MENU** to exit the "Program List Menu".

- Press ■ to cancel the operation and return to the playback screen.

6 Set "**Program**" in the preset menu to "**On**".
Tracks are played back in the selected order.

- This function can also be turned ON/OFF using the **PROGRAM** button on the remote control.

□ Program List Menu

The Program List Menu contains the following items.

Item	Explanation
Preview	Previews the selected track or file.
Insert	Registers the track or file to the Program List.
Remove	Removes the track or file from the Program List.
Remove All	Removes all tracks or files from the Program List.
Load	Reads the Program List saved onto a USB memory stick, etc.
Save	Saves the set Program List onto a USB memory device, etc.

□ Editing registered programs

1 While DN-501C is stopped, select the track that you want to edit from the “Program List” display.

2 Select “Remove” from the “Program List Menu”.
The selected file is deleted from the program.



- Only tracks on the CD and USB can be registered to the program. Files on an iPod cannot be registered to the program.
- A maximum of 99 tracks can be registered to a program.
- Select “Remove All” to delete all of the registered programs.

□ Canceling program playback

1 Set “Program” in the preset menu to “Off”.

2 Press **MENU**.
Confirm the settings.

Playing back from track hot points (Hot Start playback)

You can use the **HOT1 to 5** buttons on the DN-501C panel for hot start playback.

1 Select “Hot List” from the menu.
“Hot List” is displayed.

- If there are no tracks registered to **HOT1 to 5**, tracks are not displayed.

2 Press the jog dial.
The “Hot List Menu” is displayed.

3 Register tracks.
Select “Set”, “Auto mapping” or “Load”. When “Set” is selected, continue to select tracks.

4 Select “Execute” and register files to the “Hot List”.

5 Press **MENU** to exit the “Hot List”.

- Press **■** to cancel the operation and return to the playback screen.

6 Press **Hot 1 to 5** and the hot start button on the external remote control.
The track registered to the selected number is played back.

Registering a selected track to the Hot list

1 When a track is stopped or paused, press the **HOT SET** button while holding down the **SHIFT** button.
“Hot Number xx” is displayed.

2 Enter the hot list number that you want to register and press the jog dial.
The track is registered to the entered number.

- If the track is registered in the paused or cued state, information from that playback position is registered.

① Hot List

Displays the tracks currently registered to Hot Start.

Hot List	
01	BGM01.MP3
02	BGM02.MP3
03	Music01.WAV
04	Music02.WAV

② Hot List Menu

The Hot List Menu contains the following items.

Item	Explanation
Preview	Preview the selected track or file.
Auto Mapping	The first 20 tracks are automatically assigned from the currently selected folder.
Set	Registers the track or file in the Hot List.
Remove	Removes tracks and files from the Hot List.
Remove All	Removes all tracks and files from the Hot List.
Load	Reads hot lists from a device such as a USB memory stick.
Save	Saves the hot lists set to a USB memory stick.

iPod playback

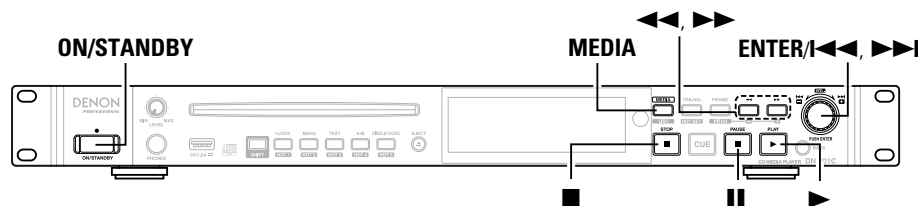

You can listen to music from an iPod using the DN-501C.

You can also control the iPod using the DN-501C or the remote control.

- For details on compatible iPod models, see “Compatible iPod/iPhone models” (page 29).



“Made for iPod” and “Made for iPhone” mean that an electronic accessory has been designed to connect specifically to iPod or iPhone, respectively, and has been certified by the developer to meet Apple performance standards.

Apple is not responsible for the operation of this device or its compliance with safety and regulatory standards. Please note that the use of this accessory with iPod or iPhone may affect wireless performance.

iPhone, iPod, iPod classic, iPod nano, iPod shuffle, and iPod touch are trademarks of Apple Inc., registered in the U.S. and other countries.

- The iPod may only be used to copy or play contents that are not copyrighted or contents for which copying or playback is legally permitted for your private use as an individual. Be sure to comply with applicable copyright laws.

NOTE

- D&M will accept no responsibility whatsoever for any loss of iPod data.
- Depending on the type of iPod and the software version, some functions may not operate.
- This unit does not support playback on an iPad. Do not connect an iPad to the unit.
- When connecting an iPhone to this unit, keep the iPhone at least 20 cm (8 inch) away from this unit. If the iPhone is kept closer to this unit and a telephone call is received by the iPhone, noise may be output from this device.
- If the iPod is connected using an iPod cable (commercially available) that is longer than 2 m (6.6 ft), sound may not be played correctly. In this case, use a genuine iPod cable, or a cable that is shorter than 1 m (3.3 ft).
- If the size of the image registered to the music file as album artwork is larger than 500 x 500 pixel, the music file cannot be played correctly. In this case, delete the album artwork from iTunes.
- When playing back from an iPod or iPhone, the headphone output is muted.

Table of corresponding remote control and iPod buttons

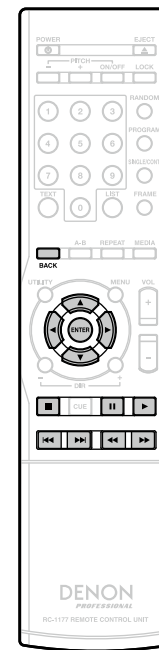

Remote control button	iPod button	DN-501C Operation
-	⏮, ⏭	Playback from start of track/Playback from next track
▶	⏩	Playback start
⏸	⏸	Pause
⏮, ⏭	⏮, ⏭ (Press and hold)	Fast forward/Fast rewind
■	-	Stop playback
△▽◀▶	Click wheel	Move cursor (up/down)
BACK	MENU	Display menu, display previous screen again
ENTER	Select	Enter item, playback track
REPEAT	-	Switch repeat playback function
RANDOM	-	Switch random playback function



The Random, Repeat and Single/Cont. settings for the DN-501C are not applied to the iPod. iPod setting status is applied.

iPod playback

1 Connect the iPod to the DN-501C.

For details on how to connect it, see “Connecting a USB device or iPod” (page 13).

2 Select “iPod/iPhone” from the “Media List”.

“Remote iPod/iPhone” appears in the display.

Remote iPod/iPhone

Compatible iPod/iPhone models

• iPod classic



iPod classic
80GB



iPod classic
160GB (2007)



iPod classic
160GB (2009)

• iPod nano



iPod nano
3rd generation
(video)
4GB 8GB



iPod nano
4th generation (video)
8GB 16GB



iPod nano
5th generation (video camera)
8GB 16GB



iPod nano
6th generation
8GB 16GB



iPod nano
7th generation
16GB

• iPod touch



iPod touch
3rd generation
32GB 64GB



iPod touch
4th generation
8GB 32GB 64GB



iPod touch
5th generation
32GB 64GB

• iPhone

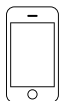

iPhone 3GS
8GB 16GB 32GB

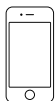

iPhone 4
8GB 16GB 32GB

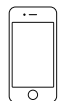

iPhone 4S
16GB 32GB 64GB



iPhone 5
16GB 32GB 64GB

Control function

Various playback functions with RC-F400S

You can perform Hot Start playback by using the hot start remote control RC-F400S (sold separately).

RC-F400S features

- Quick file search with the jog dial.
- Large 3.8" display (320X240 dots).
- Stationary top panel operations.



- With RC-F400S, you can only perform playback operations. You cannot set various menu modes (menu list/file list/file menu). When you are making changes in the menu, the RC-F400S will display "wait...".

NOTE

If the firmware version of your RC-F400S is an earlier version than A-5.00 it will not work correctly with the DN-501C. Please visit our website (URL:<http://www.d-mpro.com>) for the latest firmware version. The RC-F400S version information is displayed under the startup screen that appears when it is turned on.

Part names and functions

RC-F400S top panel

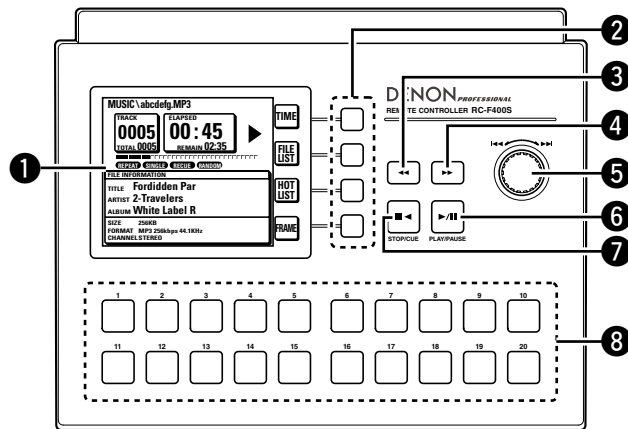

- 1 Display**
- 2 Function buttons**
Correspond to the function display.
- 3 Fast rewind button (◀◀)**
- 4 Fast forward button (▶▶)**
- 5 Jog dial (|◀◀/▶▶|)**
 - Rotate the jog dial to search for folders and files.
 - Press the jog dial to play back the selected file.

- 6 Play/Pause button (PLAY/PAUSE)**
The green light is on during playback and the green light flashes during pause.
- 7 Stop/Cue button (STOP/CUE)**
Lights orange during stop or cueing.
- 8 Hot start buttons (1-20)**
Corresponds to the Hot Start list.

RC-F400S rear panel

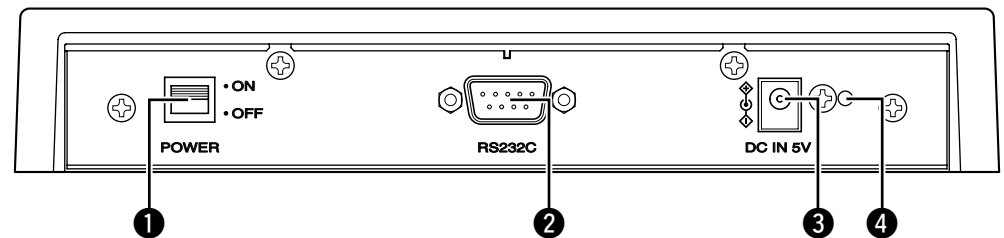

- 1 Power switch** (33)
- 2 RS-232C terminal**..... (32)
- 3 DC power input terminal** (32)
Connect the supplied power cord.

- 4 DC power cord holder mounting hole**
The supplied power cord holder will prevent the connected power cord from disconnecting from the terminal.

RC-F400S display

Main screen display

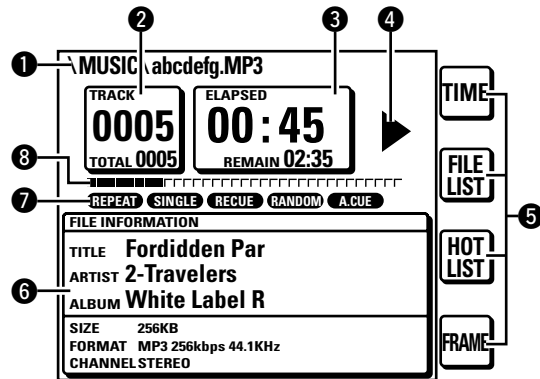

- 1 File name display**
- 2 File number/total file count display**
- 3 Time display**
- 4 Operating Status Display**
- 5 Function Display**
 - TIME: Press the function button to switch the time display.
 - FILE LIST: Press the function button to play back the file in the file list mode.
 - HOT LIST: Press the function button to check the Hot Start list.

- [Special Feature of DN-501C]**
- **FRAME**: Press the FRAME button to start Audible pause from that position, and switch to frame search mode.
- 6 File information display**
 - 7 Current playback mode display**
 - 8 Playback elapsed position**

File list display

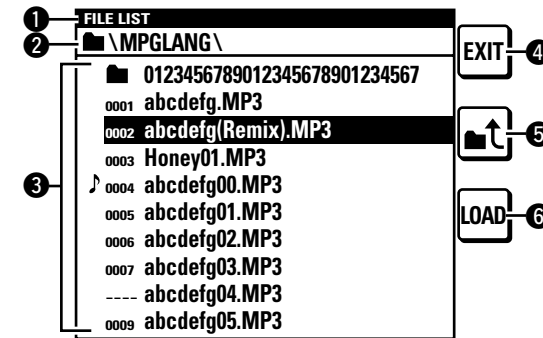

- 1 Title display**
Displays "FILE LIST".
- 2 Folder display**
Displays the folder name.
"PROGRAM PLAY" is displayed during program playback.
- 3 File list**
Displays file names.
The ♪ mark is displayed for the file that is currently being played back or set to be played back.
- 4 EXIT button**
Enters the main mode.
- 5 Up arrow button**
Displays the list of folders in the selected media.
- 6 LOAD button**
Sets the selected file to one of the Hot Start buttons 1-20.

Hot Start list display

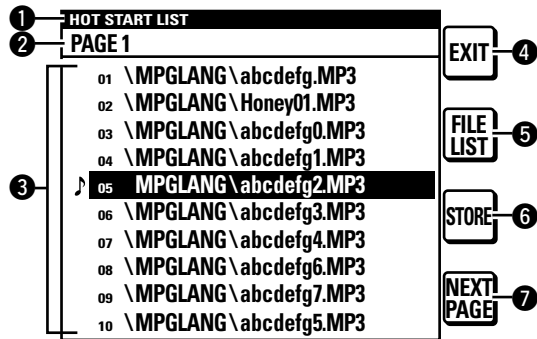

1 Title display

Displays "HOT START LIST".

2 PAGE display

Displays the page.

3 Hot Start list

Displays the set file name.

The ♪ mark is displayed for the file that is being played back.

4 EXIT button

Enters the main mode.

5 FILE LIST button

Moves to the file list.

6 STORE button

When the media is set to USB, the set Hot Start list is saved as a file.

The PPL file is saved in the root directory.

- A PPL file is the file that saves the content of a Hot Start list.

7 NEXT PAGE/PREV PAGE buttons

Display the list in the next/previous page.

Connection

As shown below, connect the RS-232C port on DN-501C to the RS-232C port on RC-F400S using the straight cable that is supplied with RC-F400S.

- Once they are connected, turn the power switch on for the respective devices.
- Configure the following items in the DN-501C "System Setting".
 - Serial bit Rate: 38400
 - Serial Protocol: RC
- After connection, fix the cable by turning the cable terminal screws.

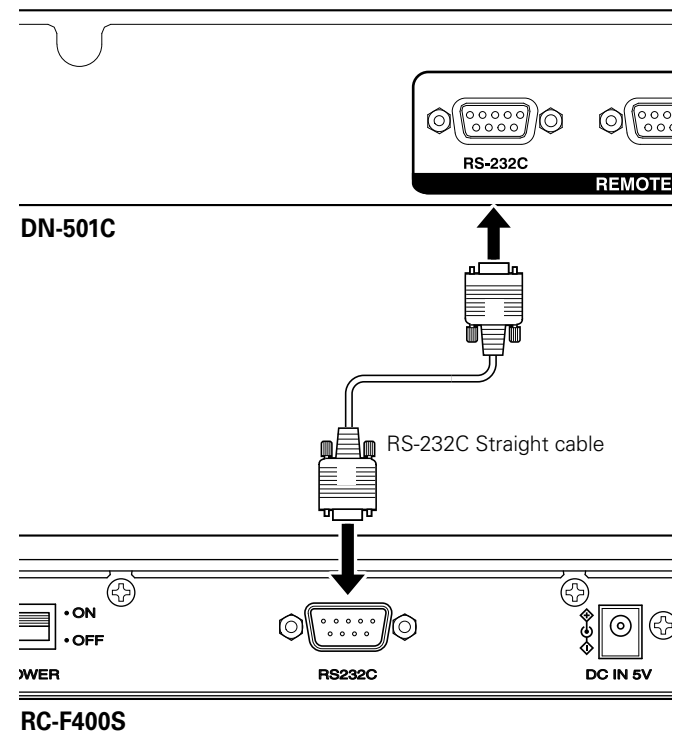

Notes on connecting the AC adapter

- Always turn the power switch off before connecting/disconnecting the AC adapter.
- Do not touch the AC adapter with wet hands.
- When disconnecting the AC adapter, make sure that you hold the plug. Pulling or bending the cord may damage the cord or cause electric shock or fire.

Hot Start playback

You can instantly start playing back a file that is registered with the Hot Start buttons 1-20 on RC-F400S by pressing the corresponding button.

☐ Perform Hot Start playback

1 After connecting DN-501C to RC-F400S, turn the power switch on for the respective devices.

- In the RC-F400S display, the startup screen "DENON PROFESSIONAL" appears.
- When the startup is completed, the file information is shown in the display.

2 Press **HOT LIST** on the main screen.

The first 10 files in the Hot Start list are displayed. To display files 11 through 20 in the Hot Start list, press **NEXT PAGE**.

3 Press the **Hot Start** button for playback.

Hot Start playback starts.



Hot Start can also be performed from the main screen and the file list screen.

☐ Pause

During playback, press ►/||.

- During pause, ►/|| flashes.
- To resume playback, press ►/||.

☐ Stop

Press ■◀.

☐ Fast forward and fast rewind (search)

During playback, press ◀◀ or ▶▶.

- Press ◀◀ to perform fast rewind playback.
- Press ▶▶ to perform fast forward playback.
- The fast forward/fast rewind speed changes in the order shown below each time the button is pressed.
 - CD-DA: x2, x5, x10, x20, x50
 - Others: x2, x10, x50, x100, x200

☐ Audible Pause

Press **FRAME** on the main screen.

- Press **FRAME** on the main screen during playback or pause to switch to the Audible Pause state.

☐ Jumping by frames (Frame Accurate Search)

Press ◀◀ or ▶▶ during Audible pause.

- Pressing ◀◀ moves 1 frame in the reverse direction.
- Pressing ▶▶ moves 1 frame in the forward direction.

❑ Set and allocate the Hot Start folder

The first 20 files in the selected folder are automatically allocated to the Hot Start buttons.

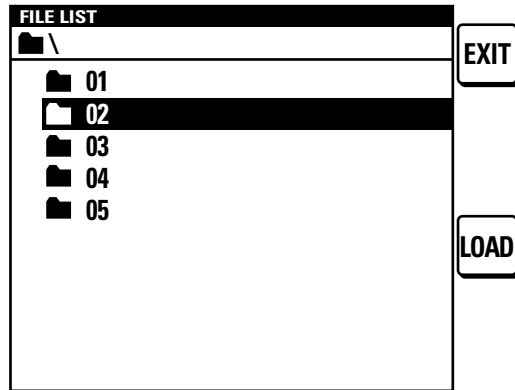

- 1 On the main screen, press FILE LIST.**
The file list is displayed.
- 2 Select the folder you would like to set with the jog dial.**
- 3 Press LOAD.**
The first 20 files in the selected folder are automatically assigned to the hot start button.
"Completed" is displayed, and the settings are completed.



These settings can only be configured during stop, pause or cue modes.

❑ Set and allocate Hot Start points

Assign the Hot Start button for the file or point that you would like to play back.

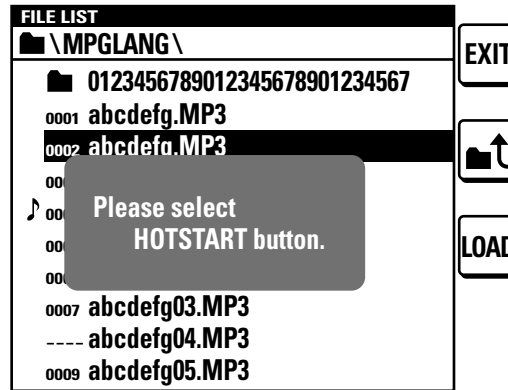

- 1 On the main screen, press FILE LIST.**
The file list is displayed.
- 2 Select the file you want to set with the jog dial. Or, pause at the point where you want to resume playback in the set file.**
Press the jog dial to play back the selected file.
- 3 Press LOAD.**
 - "Please select HOT START button" is displayed.
 - To cancel, press **■◀**.
- 4 Press the Hot Start button you want to allocate the setting to.**
 - "Completed" is displayed and the setting has changed.
 - Press the HOT START button to perform Hot Start playback.



Hot Starts can only be set in the stop or cue modes.

❑ Save the Hot Start list

Convert the allocated Hot Start list into a file and save it to a USB device connected to the DN-501C. If this file exists in the USB device, the Hot Start list in this file is automatically used for allocation.

- 1 On the main screen, press HOT LIST.**
The Hot Start list is displayed.
- 2 Press STORE.**
 - The Hot Start list is saved as "DN-501C.ppl" in the root directory of the USB device connected to the DN-501C.
 - A saved PPL file can be re-read by operating the DN-501C.

NOTE

When the Hot Start list is loaded and any audio file in the list is missing on the media, that file is removed from the Hot Start list.

Playback from the main screen

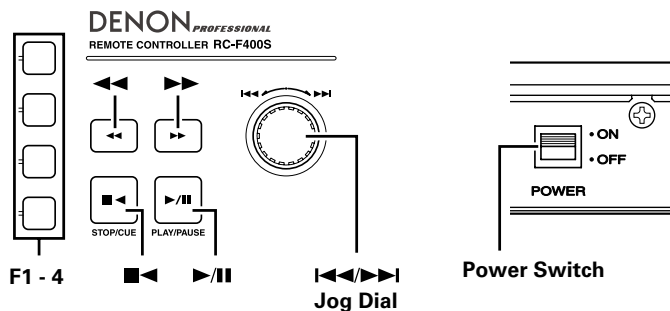

Before playback

After connecting the DN-501C to the RC-F400S, turn the power switch on for the respective devices.

- The RC-F400S display shows the startup screen "DENON PROFESSIONAL".
- When the startup is completed, the file information is shown in the display.

Play back

Press ►/II.

The button lights green and file playback starts.

Pause

Press ►/II during playback or search modes.

- ►/II flashes during pause.
- To restart playback, press ►/II.

CUE

Press ■◀.

STOP

Press ■◀ during cue.

Audible Pause

Press FRAME on the main screen.

- Press FRAME on the main screen during playback or pause to switch to the Audible Pause state.

Switching files (◀◀/▶▶)

During playback or stop, rotate the jog dial.

- Rotate clockwise to switch to the next file.
- Rotate counterclockwise to switch to the beginning of the current file or the previous file.
- To switch to the previous file, rotate the jog dial counterclockwise within one second from the start of file playback.

Fast forward or fast rewind (search)

During playback, press ◀◀ or ▶▶.

- Press ◀◀ to perform fast rewind playback.
- Press ▶▶ to perform fast forward playback.
- The fast forward/fast rewind speed changes in the order shown below each time the button is pressed.
 - CD-DA: x2, x5, x10, x20, x50
 - Others: x2, x10, x50, x100, x200



- If the "Search Mode" settings in the "Preset Menu" of the DN-501C are set to "Normal", sound is output when the search speed is 2x. Please note that sound is not output at search speeds above 2x.
- After you fast forward to the end of the last file or fast rewind to the beginning of the first file, the unit pauses.
- When you fast rewind to the beginning of the file, the fast rewind operation continues from the end point of the previous file.

NOTE

- When you perform search on a short file, the indicated speed may not be available.
- You cannot perform search on files that are recorded in VBR.
- If searched files contain a VBR file, the search stops at that VBR file.

Jump by frames (Frame Accurate Search)

Press ◀◀ or ▶▶ during Audible Pause.

- Pressing ◀◀ moves 1 frame in the reverse direction.
- Pressing ▶▶ moves 1 frame in the forward direction.

AUTO CUE

AUTO CUE automatically detects the audio level and performs the cue operation.

- When AUTO CUE is enabled, the playback mode display in the RC-F400S display shows **A.CUE**.
- The detected level is the set value for the preset menu "Auto Cue" in DN-501C (page 15).
- If the audio level is not detected for 20 seconds or more after the playback for automatic detection of the audio level has started, the cue operation is performed at the beginning of the file.

Other functions

Lock operating buttons (Key lock)

When LOCK is pressed for more than 1 second, the buttons in the following table are locked and you will not be able to operate them. Switch the lock status as shown below.



- If buttons are operated while the key lock is enabled, "Key Locked" is displayed.

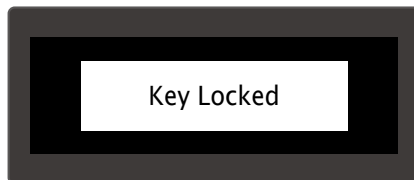

Lock cancel: All buttons can be operated.

Specific button lock: All buttons other than those needed for playback operations are locked.

All lock: All buttons other than Lock and Shift are locked.

Status	SHIFT	LOCK	POWER	PLAY	PAUSE	CUE	STOP	SHIFT+ HOT XX	FRAME	◀◀/▶▶	JOG (◀◀/▶▶)	Other
All Keys Unlocked	○	○	○	○	○	○	○	○	○	○	○	○
Keys Restricted	○	○	×	○	○	○	○	○	○	○	○	×
All Keys Locked	○	○	×	×	×	×	×	×	×	×	×	×

- : Can be operated.
- ×: Cannot be operated.

"DENON Professional Pitch Control" App for iPhone/iPod Touch

This application enables playback and pitch control of tracks on your iPod Touch/iPhone.

For details such as operating conditions etc, see our website <http://www.d-mpro.com>.



Serial remote control function

In the serial remote control function, a host such as a computer is connected to the unit. By sending control commands from the host to the unit, the unit can be operated, and the status information of the unit can be checked both on the unit and host.

RS-232C control

You will be able to perform the three control functions from the host by connecting an RS-232C straight cable to the RS-232C serial terminal (9-pin D-sub) connector.

[Three control functions]

- ① Controlling the DN-501C externally
- ② Sending the status information to the host when DN-501C receives a status request command from the host
- ③ Automatically sending the status information to the host when there is a change to the DN-501C status

□ About Connections

- Transmission System: Asynchronous full duplex transmission
- Compatible connector: 9-pin D-sub (male)
- Communication speed: 9,600/38,400 bps selectable
- Data bit: 8 bit
- Parity: None
- Start bit: 1 bit
- Stop bit: 1 bit
- Flow control: None

Pin arrangement

Pin number	Signal name
1	Ground
6	NC
2	TxD
7	RTS*
3	RxD
8	NC
4	NC
9	NC
5	S. Ground

* 4V/500mA power supply can be used for RTS.

Connections

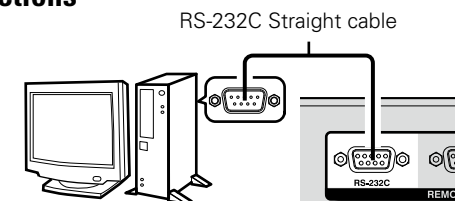

Extended Communication Format (MIDI)

❑ Controlling the DN-501C externally

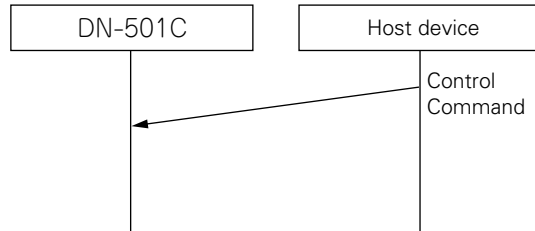

Control commands are commands such as play, stop etc. sent from the controller to control the DN-501C.

❑ Status information output for external status request commands

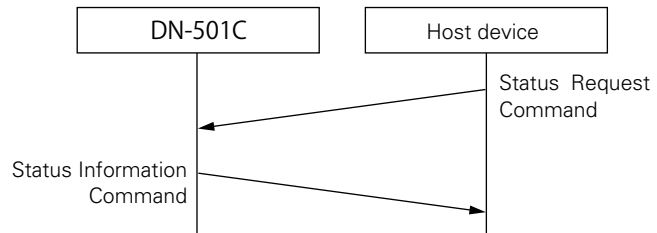

The status request command is a command used to obtain status information from the DN-501C. When the DN-501C receives a status request command, it uses a status information command to notify its status.

❑ Automatic output of status information when the DN-501C status changes

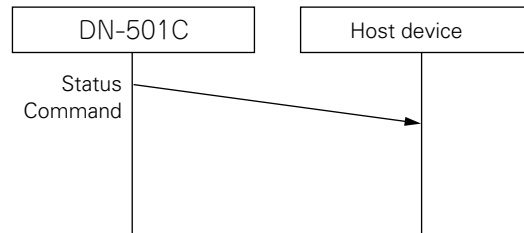

The status notification command is automatically generated when the DN-501C changes status. The status notification uses an information command to notify the host of the status.

❑ Command Sending Format

Commands are issued using a Command Packet surrounded by the Start Byte and End Byte.

0x F0004003 (Start Byte)	CommandPacket	0xF7 (End byte)
-----------------------------	---------------	--------------------

The Command Packet format is as shown below.

Format (0x11)	Total Command Packet (1byte)	Remain Command Packet (1byte)	Command (2bytes)	Parameter Pack Length (1byte)	Parameter Pack (0-80bytes)	Check Sum (2bytes)
---------------	------------------------------	-------------------------------	------------------	-------------------------------	----------------------------	--------------------

Item	Content
Format	Fixed as 0x11 in the DN-501C.
Total Command Packet	Used to send commands that have parameters that do not fit into the Parameter Pack. This is 1 when the parameter is less than 80 bytes.
Remain Command Packet	Used to send commands that have parameters that do not fit into the Parameter Pack. This is 0 when the parameter is less than 80 bytes.
Command	Consists of 2 bytes from the category code and command.
Parameter Pack Length	Describes the length of the Parameter Pack. The maximum length of the Parameter Pack is 80 bytes.
Parameter Pack	Parameters.
Check Sum	All of the bytes from the Format to the Parameter Pack are added, and the top 4 bits and bottom 4 bits are each converted to ASCII code and stored.

❑ Divided transmission of commands

If a Parameter Pack exceeds 80 bytes, the command is divided and sent.

In this case, the Total Command Packet contains the total number of commands, and the Remain Command Packet contains the remaining number of transmissions.

❑ RemainCommandPacket for a command divided and sent in 3 parts

	Total Command Packet	Remain Command Packet	Description
1st	3	2	Two Command Packets remain
2nd	3	1	One Command Packet remains
3rd	3	0	No Command Packets remain

The divided Parameter Pack is reconstructed by the receiver, and is interpreted as the parameters for one command.

1st part

Format-Model ID	Total 3	Remain 2	Command	Length	Parameter part 1	Sum
-----------------	---------	----------	---------	--------	------------------	-----

2nd part

Format-Model ID	Total 3	Remain 1	Command	Length	Parameter part 2	Sum
-----------------	---------	----------	---------	--------	------------------	-----

3rd part

Format-Model ID	Total 3	Remain 0	Command	Length	Parameter part 3	Sum
-----------------	---------	----------	---------	--------	------------------	-----

Interpretation of received command

Command	Parameter part 1	Parameter part 2	Parameter part 3
---------	------------------	------------------	------------------

❑ Precautions when dividing commands

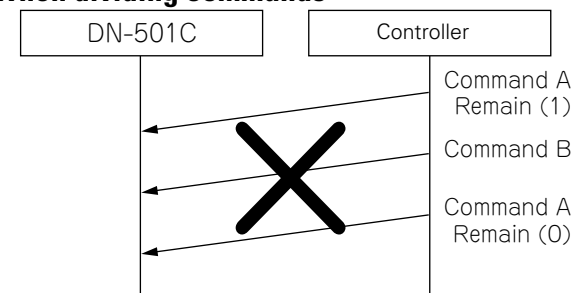

Do not send any other commands in between sending parts of divided commands. In such a case, DN-501C will discard command A.

Commands can be divided to a maximum of 10 parts. Do not divide into 11 or more parts. Do not divide the command if the parameters are less than 80 bytes.

parameter	description
Number	Numerical value
Name String	Character string
TIME STRING	Expression: MMM:SS;FF Colon is used between MMM and SS (:) 0x3A Semicolon is used between SS and FF (;) 0x3B MMM is displayed in 3 digits with 0 embedded expressions (000 - 999) In ASCII, each digit is expressed in ASCII SS is displayed in 2 digits with 0 embedded expressions (00 - 59) In ASCII, each digit is expressed in ASCII FF is displayed in 2 digits with 0 embedded expressions (00 - 74) In ASCII, each digit is expressed in ASCII 012:34;56 is transmitted as 0x30 0x31 0x32 0x3A 0x33 0x34 0x3b 0x35 0x36
Dimmer Value	1 - 5 integer expression
Sample Rate	Hz unit numerical value
Lock No.	0:All Keys available 1:Only Transport Keys Available 2:All Keys Locked
Version No	SSMMmmRR SS is a specification code (0x00=A,0x01=B...0x19=Z) MM is a major code(0 - 0x63) mm is a minor code(0 - 0x63) RR is a revision code (0 - 0x63) Ex. When SSMMmmRR=0x00010000, A-1.00
File Name String Folder Name String Media Name String	Folder delimiter is '\(0x5C)' Media name is "CDA:", "CDD:" or "USB:" CDA indicates CD-DA CDD indicates CD-DATA USB indicates USB storage Media name ends in ':' (colon) Folder name ends in '\' <root> indicates "\\" Absolute path is expressed as "\\Folder name\Folder name\ Relative path is expressed as "Folder name\Folder name\ Folder in one superior hierarchy level is expressed as "..\ Current folder is expressed as ".\ File name is expressed as "Track name:extension" Combinations of the expressions above can be used E.g.) Expression of a full path from the media "CDD:\Folder name\Track name.MP3" E.g.) Expression of a full path from <root> "\\Folder name\Folder name\Track name.MP3"
Hot number	Value from 1 - 20 1 byte, not ASCII coded even with ASCII systems

parameter	description
Track number	Value from 0 - 1999 2 byte binary value. 0 - 7CF Transfer order from top down. In ASCII systems, each digit of a track number expressed in base 10 is transferred in ASCII code. Range of 0x30 0x30 0x30 0x30 - 0x31 0x39 0x39 0x39.
Pitch value	DN-501C has a range of $\pm 16.00\%$. However, the second value after the decimal is always 0. This value is multiplied by 100 and transferred. The specification range is $\pm 999.99\%$. In binary mode, a 3-byte value is transferred. Transfer order from top down. In ASCII systems, each digit of a pitch expressed in base 10 is transferred in ASCII code. Upper order values are zero filled. Transmission order is symbol, hundreds, tens, ones, first decimal, second decimal. The symbol is not coded to ASCII, and is sent as 0 or 1.
Current Track Audio Format String	For PCM WAV\Sampling rate\quantization bit rate (WAV file) AIFF\Sampling rate\quantization bit rate (AIFF file) For compressed formats MP3\Sampling rate\Bit rate (MP3 file) M4A\Sampling rate\Bit rate (AAC/iTunes format) MP4\Sampling rate\Bit rate (MP4 file) Sampling rate: Hz unit numerical value. In the ASCII format, each digit is converted to ASCII. Quantization bit number: bit number such as 16/24 etc. In the ASCII format, each digit is converted to ASCII. Bit Rate: Numerical value in kbps unit such as 320 etc. In the ASCII format, each digit is converted to ASCII.

NOTE

About the command list see page "Appendix".

D&M RC Communication format (RC)

❑ Configuration of control commands

The packets of control commands start with the Start Character “@”, and end with the End Character “0x0D” as shown below.



❑ Configuration of command codes

Item	Value (Hex value within parentheses)
Start Character	'@' (0x40)
ID	'0' (0x30)
Command	Indicates the command details.
End Character	'\r' (0x0D)

Response timeout is 100msec.

❑ ACK (received successfully) and NACK (receive failed) command codes

Content	Hex value	Transmission conditions
ACK	0x06	—
NACK	0x15	<ul style="list-style-type: none"> • When an End Character (0x0D) is received with no Start Character “@” • When a command that does not exist is received • When there is a space more than 5msec between command characters



- When a command is received, ACK or NACK is returned within 100 msec.
- If there is no response after 100 msec, the next command is permitted.

① External control and operation of the DN-501C

When the DN-501C receives a control command from the host, the DN-501C sends ACK (received successfully) to the host and executes the command.

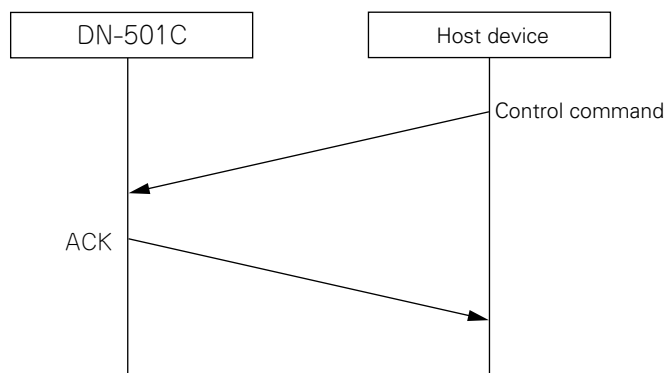

However, if data other than a specified command or an End Character (0x0D) with no Start Character '@' is received, receive fails and NACK is returned.

② Status information output for external status request commands

When a status request is received from the host, the DN-501C returns ACK and a response to the request details.

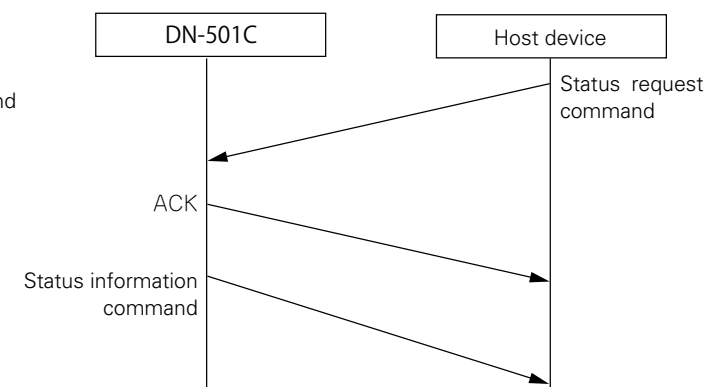

Sequence diagram of status request command

However, if data other than a specified command or an End Character (0x0D) with no Start Character ('@') is received, receive fails and NACK is returned.

③ Automatic output of status information when the DN-501C status changes

When the DN-501C status or recording or playback file changes, or when the storage status changes, the details of the change of status are sent to the host.

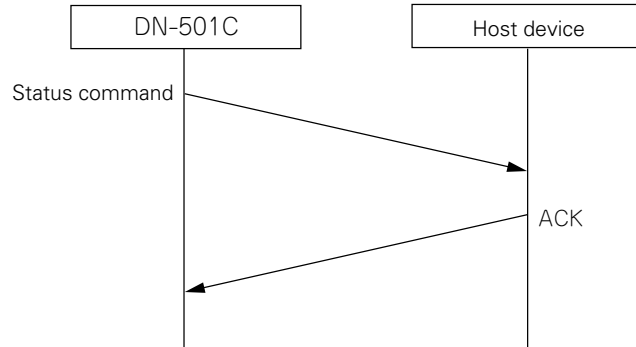

The command sent at this time uses the same status information command as ②.

NOTE

About the command list see page "Appendix".

Parallel Control

Parallel control has two modes, normal mode and hot start mode.
The MODE 1,2 pins are used to switch this mode.

□ Parallel remote mode switching

- Parallel remote mode is switched according to the status of parallel remote inputs #5 and #6.

MODE 1	HIGH	HIGH	LOW	LOW
MODE 2	HIGH	LOW	HIGH	LOW
FUNCTION	NORMAL	Reserved	HOT START 1	HOT START 2

Hot Start 1: Hot list #1 - #10 can be played from the parallel remote.
Hot Start 2: Hot list #11 - #20 can be played from the parallel remote.



Hot start is a function that starts playback instantaneously from the preset point.

Hot Start mode can be switched to Hot Cue using “Para Rem Mode” in the “Preset setting”.
If the mode is set to the Hot Cue mode, when Hot Start input is performed, playback does not start immediately and instead switches to the standby state at the start point.

□ Hot Start Assignment

If one of the HOT START terminals is shorted when the RELOAD terminal is in the shorted state, the current track is assigned to the shorted Hot Start number (reload function).
For details on assigning Hot Start, see “Playing back from track hot points (Hot Start playback)” (page 27).

□ About Connections

• Normal Mode

NO.	DN-501C	
	I/O	NAME
1	-	GND
2	I	PLAY
3	I	PAUSE
4	I	CUE
5	I	MODE 1
6	I	MODE 2
7	I	SEARCH ►►
8	I	SEARCH ◄◄
9	I	FADER START
10	-	GND
11	I	SKIP BACK
12	I	Reserved
13	I	Reserved
14	O	PLAY TALLY
15	O	PAUSE TALLY
16	O	CUE TALLY
17	I	Reserved
18	I	Reserved
19	I	Reserved
20	O	STOP TALLY
21	O	EOM TALLY
22	-	TALLY POWER SUPPLY
23	-	GND
24	I	TRACK +
25	I	TRACK -

• Hot Start Mode / Hot Cue Mode

NO.	DN-501C	
	I/O	NAME
1	-	GND
2	I	PLAY
3	I	PAUSE
4	I	CUE
5	I	MODE 1
6	I	MODE 2
7	I	RELOAD
8	I	HOT START 1(11)
9	I	HOT START 2(12)
10	-	GND
11	I	HOT START 3(13)
12	I	HOT START 4(14)
13	I	HOT START 5(15)
14	O	PLAY TALLY
15	O	PAUSE TALLY
16	O	CUE TALLY
17	I	HOT START 6(16)
18	I	HOT START 7(17)
19	I	HOT START 8(18)
20	O	STOP TALLY
21	O	EOM TALLY
22	-	TALLY POWER SUPPLY
23	-	GND
24	I	HOT START 9(19)
25	I	HOT START 10(20)

- In Hot Cue mode, the status switches to standby for hot start input.
- The (I) contents indicate the assignment for Hot Start 2 mode.

Remote Control Connection

Connection Example

Normal Mode

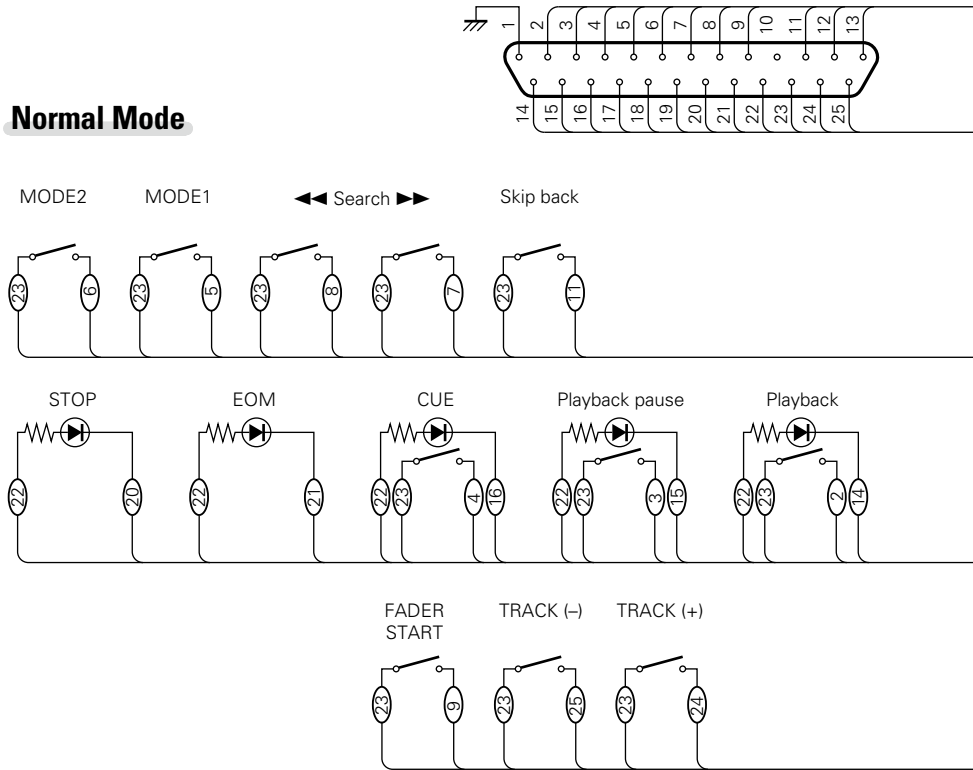

Hot Start Mode

Hot Cue Mode

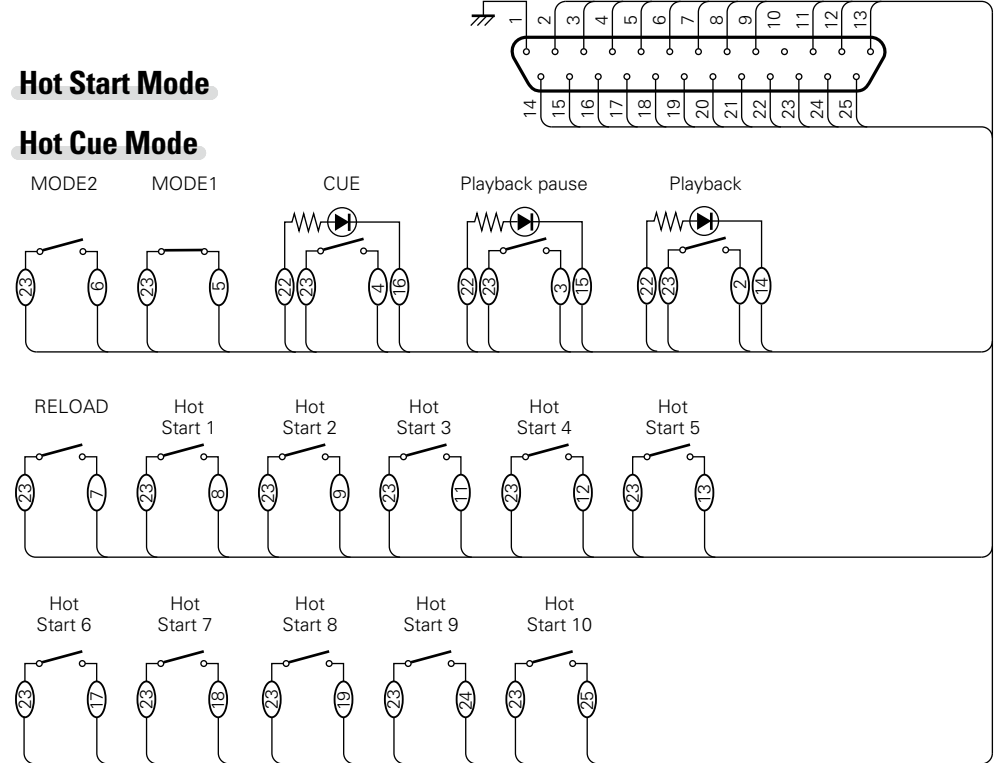

It is assumed that the input pins and Tally output pins are used as follows.

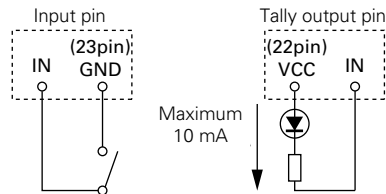

- Tally output pin is an open collector. (Maximum current: 10 mA, maximum voltage; 5.5 V)
- Input pin is 5 V for Vcc TTL specification.
- The maximum current supplied by the Tally Power Supply (22 pin) is 100 mA.
- The input/output logic is active low (negative logic).

NOTE

Power is supplied to the external remote controller from Pin No.22 (Tally Power Supply) from this terminal. However, as the maximum rating for this pin is +5 VDC 100 mA, select circuit and current controls (resistance values) so as not to exceed the rating. Using this equipment when the rated value is exceeded may cause damage to the equipment, which may also lead to fire or a similar unexpected accident.

Error messages

Details on procedure for handling error messages

Error message	Cause/Solution	Page
No Media	<ul style="list-style-type: none"> Cannot detect media. 	13
Unformat	<ul style="list-style-type: none"> The media is formatted in an unsupported format. Format the media on DN-501C or set the format to FAT16 or FAT32. For details, see the operation instructions of the recording media. 	–
Media Full	<ul style="list-style-type: none"> The remaining space on a media is running low. Replace the media with a new one or delete files that are no longer required. 	–
File Not Found	<ul style="list-style-type: none"> Target file does not exist. Check the file. 	20
Hot Start Not Assigned	<ul style="list-style-type: none"> There is no track registered to the selected hot start button. Register a track to the hot start button. 	27, 34
VBR	<ul style="list-style-type: none"> This error message appears when a VBR file search is performed. Search cannot be performed on VBR files. The remaining time of a file is not displayed either. 	24
Already Exists	<ul style="list-style-type: none"> A file with the same file name already exists. Change the file name and then press the jog dial to enter the data. 	20
Keys Restricted All Keys Locked	<ul style="list-style-type: none"> Key lock is activated. To operate DN-501C, cancel the lock. 	36
IR Locked	<ul style="list-style-type: none"> Remote control operations are locked. To operate the remote control, cancel the lock. 	17
Not allowed	<ul style="list-style-type: none"> This appears when an invalid operation is performed. Check the details of the operation because the operation may be invalid due to other setting items such as the preset menu etc. 	14
Err Format	<ul style="list-style-type: none"> Format the media on DN-501C or set the format to FAT16 or FAT32. For details, see the operation instructions of the media. 	–
Err Media X	<ul style="list-style-type: none"> The media is not compatible with the DN-501C. Replace with compatible media. 	–

Error message	Cause/Solution	Page
ErrUpdateFile	<ul style="list-style-type: none"> Error in upgrading a file or file system. Contact your local Denon repair service center listed on our website (URL: http://www.d-mpro.com). 	–
Err FlashROM	<ul style="list-style-type: none"> Error in flash ROM. Contact your local Denon repair service center listed on our website (URL: http://www.d-mpro.com). 	–
Track Not Found	<ul style="list-style-type: none"> The target track does not exist. Check the media. 	–
Some files are skipped	<ul style="list-style-type: none"> Some file operations were skipped because files with the same name exist. Check the file name. 	–
Password Error	<ul style="list-style-type: none"> Password authentication failed. Check the password. 	–

RC-F400S error messages

Error message	Cause/Solution	Page
Not Connected	<ul style="list-style-type: none"> Check if it is properly connected to DN-501C. If this message persists, replace the cable. 	–
Not Supported	<ul style="list-style-type: none"> A device that is not supported by RC-F400S is connected. Check the connected device. 	–
No Media	<ul style="list-style-type: none"> The media inserted in DN-501C has not been detected. Eject and insert the media again. 	13

Troubleshooting

If a problem should arise, first check the following:

1. Are the connections correct?

2. Is the set being operated as described in the owner's manual?

3. Are the external devices (mixer and player) operating properly?

If this unit does not operate properly, check the items listed in the table below.

If the symptom is not covered on the check list, contact your dealer or service centers.

Service centers are listed at <http://www.d-mpro.com>.

[General]

Symptom	Cause/Solution	Page
Does not power on.	<ul style="list-style-type: none"> Check whether the power cord is firmly connected to the AC outlet. 	12

[Playback]

Symptom	Cause/Solution	Page
Cannot perform playback or does not recognize a file.	<ul style="list-style-type: none"> The media could be a cause of this trouble. Copy a file to another media and retry playback. 	–
	<ul style="list-style-type: none"> Check whether this unit supports the format of the playback file. 	–
	<ul style="list-style-type: none"> Check that the target folder is stored within the first 8 levels of the media root directory. Check whether the number of folders does not exceed 1000. This unit recognizes up to 1000 folders. 	20
No sound is produced from the headphones.	<ul style="list-style-type: none"> Make sure that the headphone volume level adjustment switch (LEVEL) is not set to MIN. 	12
	<ul style="list-style-type: none"> Check whether sound is reproduced from the headphones by using another audio file or recording media. 	–

[Recording media]

Symptom	Cause/Solution	Page
The media is not shown in the display even though it is connected.	<ul style="list-style-type: none"> Sometimes this unit cannot recognize media because of a defective connection. Check the connection of the media. 	13
	<ul style="list-style-type: none"> This unit supports USB mass-storage class flash memory and USB external storage. It does not recognize USB drives other than the above. 	13
	<ul style="list-style-type: none"> You cannot connect USB devices to this unit via a USB hub. Make sure to supply external power to the type of USB hard disk drives that can connect to the external power source via AC adapter, etc. 	–
The media icon is displayed, but the unit does not recognize a file.	<ul style="list-style-type: none"> Check the display and make sure that the currently selected media and the actual media that you want to use are the same. If they are not the same, display the media list to select the media to be used. 	22

Warranty

WARRANTY ONLY IN U.S.A.

LIMITED WARRANTY FOR PROFESSIONAL PRODUCTS

This warranty will be honored only in the U.S.A.

Length of Warranty

The warranty on your DENON Professional product which is distributed and warranted by D&M Professional will remain in effect when purchased from an Authorized D&M Professional Reseller for 1 year Parts and Labor.

What is Covered

Except as specified below, this Warranty covers all defects in material and workmanship in this product. The following are not covered by the Warranty:

- (1) Any product which is not distributed in the U.S.A. by DENON Professional div. D&M Professional.
- (2) Any product on which the serial number has been defaced, modified or removed.
- (3) Damaged deterioration or malfunction resulting from:
 - a) Accident, act of nature, abuse, misuse, neglect, unauthorized product repair or modification or failure to follow instructions supplied with the product.
 - b) Repair or attempted repair by anyone not authorized by DENON Professional.
 - c) Any shipment of the product (claim must be presented to carrier).
- (4) Items subject to wear from normal usage (tape heads, cartridges, stylus, battery, etc.).
- (5) Periodic check-ups which do not disclose any defect.
- (6) Use of the product outside the U.S.A.
- (7) Damaged magnetic tape or CD/DVD/BD discs.

What We Will Pay For

If during the applicable warranty period from the date of original consumer purchase your DENON Professional product is found to be defective by D&M Professional, D&M Professional will repair, or at its option, replace with new, used or equivalent model, such defective product without charge for parts or labor.

How to Obtain Warranty Performance

If your unit requires service under the warranty period, telephone the D&M Professional Technical Service and Support Department for available warranty repair options. You can find the contact details on our website (<http://usa.d-mpro.com/>). During the warranty period, the following procedures apply:

- a. A copy of the original, dated retail sales receipt from an authorized reseller is required for warranty repair.
- b. All warranty repairs require a service return authorization prior to shipment to the service center.
- c. You are responsible for shipping charges to the service center. Warranty repaired units will be returned to you freight prepaid.
- d. You should include the following: your name, address, daytime telephone number, model and serial number of the product and a description of the problem. In the case of a CD/DVD/BD Player, please enclose ONE (1) disc that the unit has failed with for test reasons. It will be returned with the unit.

THIS WARRANTY IS VALID IN THE U.S.A. ONLY.

If your product does not require service, but you have questions regarding its operation, please contact our Technical Services Department as listed below.

THIS WARRANTY IS EXPRESSLY MADE IN LIEU OF ALL OTHER WARRANTIES, EXPRESSED OR IMPLIED, INCLUDING WITHOUT LIMITATION, WARRANTIES OF MERCHANTABILITY AND FITNESS FOR A PARTICULAR PURPOSE.

OUR LIABILITY IS LIMITED TO THE REPAIR OR REPLACEMENT, AT OUR OPTION, OF ANY DEFECTIVE PRODUCT AND SHALL IN NO EVENT INCLUDE INCIDENTAL OR CONSEQUENTIAL COMMERCIAL OR PROPERTY DAMAGES OF ANY KIND.

SOME STATES DO NOT ALLOW LIMITATIONS ON HOW LONG AN IMPLIED WARRANTY LASTS AND/OR DO NOT ALLOW THE EXCLUSION OF INCIDENTAL OR CONSEQUENTIAL DAMAGES, SO THE ABOVE LIMITATIONS AND EXCLUSIONS MAY NOT APPLY TO YOU.

This warranty gives you specific legal rights, but you may also have other rights which vary from state to state.

D&M Professional AMERICA

<http://usa.d-mpro.com/>

You can find the contact details on this website.

WARRANTY IN EUROPE AND ASIA

In Europe and Asia (except Japan), the warranty of this product is supplied by your local importer. Please contact your point of purchase for help with warranty claims.

D&M Professional EUROPE

<http://www.dm-pro.eu/>

D&M Professional ASIA

<http://apac.d-mpro.com/>

Main Specifications

❑ Digital Audio System

- **System** CD/Media Player
- **Compatible media** CD Media, USB flash memory, USB HDD, iPod/iPhone
- **Playable formats, file systems** CD: CD-DA (CD TEXT), CD-ROM (ISO9660)
USB: FAT16/FAT32/HFS+
- **Playable WAV Format**
 - Extension** WAV
 - Resolution** 16 bit, 24 bit
 - Sampling frequency** 96, 48, 44.1 kHz
- **Playable AIFF Format**
 - Extension** AIFF, AIF
 - Resolution** 16 bit, 24 bit
 - Sampling frequency** 96, 48, 44.1 kHz
- **Playable MP3 Format**
 - Extension** MP3
 - Bit rate** 32 – 320 kbps and VBR
 - Sampling frequency** 48, 44.1 kHz
- **Playable AAC Format**
 - Extension** M4A
 - Compression method** AAC-LC
 - Bit rate** 64 – 320 kbps and VBR
 - Sampling frequency** 48, 44.1 kHz
- **Number of channels** 2 (stereo), 1 (mono)
- **Audio frequency characteristics** 20 Hz - 20 kHz (±0.5 dB)
- **S/N ratio** More than 105 dB (A-Weighted)
- **Total harmonic distortion** Less than 0.005 %
- **Dynamic range** More than 105 dB (for 24 bit WAV playback)
- **Channel separation** Less than -106 dB
- **Variable pitch width** -16 % – +16 % (0.1% step)
- **Variable Output trim adjustment width** ±2.0dB (0.1dB step)

❑ Output

- **BALANCED ANALOG OUT L/R**
 - Type** XLR(1:GND, 2:Hot, 3:Cold)
 - Load impedance** Over 600 Ω/ohms
 - Output level** +6dBV (+8.23dBu) (600Ω/ohms Load)
 - Output level setting** +24dBu, +20dBu, +18dBu, +6dBV (0dBFS Reference)
- **UNBALANCED ANALOG OUT L/R**
 - Type** RCA terminal
 - Load impedance** Over 10 kΩ/kohms
 - Output level** +6dBV (10kΩ/kohms Load)
 - Output level setting** +10dBV, +6dBV, +4dBV (0dBFS Reference)
- **BALANCED DIGITAL OUT**
 - Type** XLR(1:GND, 2:Hot, 3:Cold)
 - Output impedance** 110 Ω/ohms
 - Format** IEC-60958(AES/EBU)
- **UNBALANCED DIGITAL OUT**
 - Type** RCA terminal
 - Output impedance** 75 Ω/ohms
 - Standard output level** 0.5 Vp-p
 - Format** IEC-60958(COAXIAL)
- **HEADPHONE OUT** 20 mW/32 Ω/ohms
- ❑ **Others**
 - **Maximum storage capacity** Up to 2 TB
 - **Maximum file size** 2 GB
 - **Maximum number of files** 2000 files (for 1 folder)
 - **Maximum number of folders** 1000 folders
 - **Maximum number of folder hierarchies** 8 (under the root directory)
 - **Maximum file name length** 255 characters
 - **Maximum folder name length** 255 characters

0 dBu=0.775 Vrms,
0 dBV=1.0 Vrms

❑ General

- **Power supply** AC 120 V, 60 Hz (U.S.A and Canada models)
AC 230 V, 50/60 Hz (European, U.K and Asia/Pacific models)
- **Power consumption** 30 W
0.4 W (standby)
- **Environmental conditions**
 - Operating temperature** 5 – 35 °C
 - Operating humidity** 25 – 85 %, no condensation
 - Storage temperature** -20 – 60 °C

※ Specifications and external appearance may be changed without prior notice for improvement purposes.



Index

A		L	
Accessories	2	Load Setting	18
C		M	
Cable		Menu List	14
Balanced cable	11	Menu Operations	15
Coaxial digital cable	11	P	
Stereo audio cable	11	Parallel Control	43
CD-R/CD-RW	3	Pitch control	25
Connection		Playback	23
Analog balanced	11	A-B Repeat	25
Analog unbalanced	11	Cue	23
Digital	11	Frame jump	24
Digital (AES/EBU)	11	iPod	28
Headphones	12	Pause	23
iPod	13	Search	24
Parallel	12	Stop	23
Power cord	12	Preset Setting	15
RC-F400S	32	Program playback	26
RS-232C	12	Property	21
USB device	13	R	
Copy	21	Rear Panel	5
D		Remote control unit	6
DENON Professional Pitch Control	36	Inserting the batteries	7
Direct jump	26	RS-232C control	37
Display	8	S	
E		Save Setting	18
Error messages	45	Select	20
F		Select All	20
File List Menu	20	Single/Cont.	26
Firmware Version	18	Skip back	26
Format Media	19	System setting	17
Front Panel	4	T	
H		Troubleshooting	46
Headphones	12	W	
Hot list	27	Warranty	47
Hot Start playback	27		

Appendix

Appendix shows the list of commands that control this unit externally through a host device. Normally, it is dealers such as installers that use the list of commands to make settings, so this section is only in English.

Extended Communication Format (MIDI)

Control Command List

Category	Command	Command code		Parameter 1	Parameter 2	Remarks
		Category code	Command number			
Playback operation	STOP	0	1	-	-	Command example) F0 00 40 03 11 01 00 00 01 00 31 33 F7
	PLAY	0	2	-	-	Command example) F0 00 40 03 11 01 00 00 02 00 31 34 F7
	PAUSE	0	3	-	-	-
	CUE	0	4	-	-	-
	CUE TRK XXXX	0	5	Number	-	Track No. 2 bytes specification (DN501C extended to 4 bytes)
	CUE TIM XXXX	0	6	TIME STRING.	-	TIME STRING specified
	FRAME FWD	0	7	-	-	-
	FRAME REV	0	8	-	-	-
	SEARCH SS1 FWD	0	10	-	-	-
	SEARCH SS1 REV	0	11	-	-	-
	SEARCH SS2 FWD	0	12	-	-	-
	SEARCH SS2 REV	0	13	-	-	-
	SEARCH SS3 FWD	0	14	-	-	-
	SEARCH SS3 REV	0	15	-	-	-
	SEARCH SS4 FWD	0	16	-	-	-
	SEARCH SS4 REV	0	17	-	-	-
	SEARCH SS5 FWD	0	18	-	-	-
	SEARCH SS5 REV	0	19	-	-	-
	TRACK FWD	0	20	-	-	-
	TRACK REV	0	21	-	-	-
	HOT START XXXX	0	22	Number	-	Hot No. 1 byte specification (1 - 20)
	HOT CUE XXXX	0	23	Number	-	Hot No. 1 byte specification (1 - 20)
	SKIP BACK	0	24	-	-	-
	FRAME ON	0	25	Number	-	ON:1/OFF:0
	END MONITOR	0	26	-	-	-
	Device operation	POWER ON	1	1	-	-
POWER STDBY		1	2	-	-	-
RETRACT		1	3	-	-	-
EJECT		1	4	-	-	-
UNBAL VOL UP		1	5	Number	-	Volume Up Step Up Count 1 byte received side is interpreted as Count value x volume minimum step (dB) Up.
UNBAL VOL DN		1	6	Number	-	Volume Down Step Count 1 byte received side is interpreted as Count value x volume minimum step (dB) Down.
UNBAL VOL XXXX		1	7	Number	-	Volume Value 4bytes specification Byte1 symbol =0:positive/1:negative Byte2 Volume(db) ten value (0 - 9) Byte3 Volume(db) single value (0 - 9) Byte4 Volume(db) first decimal value (0 - 9) Byte5 Volume(db) first decimal value (0 - 9)
ENTER		1	8	-	-	-
ESC		1	9	-	-	-
ABORT		1	10	-	-	-
ARROW D		1	11	-	-	-
ARROW U		1	12	-	-	-
ARROW R		1	13	-	-	-
ARROW L		1	14	-	-	-

Category	Command	Command code		Parameter 1	Parameter 2	Remarks
		Category code	Command number			
File operation	HOT LOAD XXXX	3	3	Name String		Parameter1=File Name String specification
	HOT SAVE XXXX	3	4	Name String	-	PPL File Name String specification
	PRG LOAD XXXX	3	5	Name String	-	m3u File Name String specification
	PRG SAVE XXXX	3	6	Name String	-	m3u File Name String specification
Playback setting	HOT SET XXXX	5	1	Number	-	Hot No. 1 byte specification (1 - 20)
	HOT SET XXXX YYYY	5	2	Number	Number	Parameter1=Hot No. 1byte Parameter2= Track No. 2byte specification (Extended to 4 bytes in ASCII system)
	HOT RMV XXXX	5	3	Number	-	Hot No. 1byte specification
	HOT IN XXXX YYYY	5	7	Number	TIME STRING.	Parameter1=Hot No. 1byte Parameter2=TIME STRING specification
	PRG INS XXXX	5	11	Number	-	Insert Position No. 2bytes specification (ASCII system extended to 4 bytes)
	PRG INS XXXX YYYY	5	12	Number	Number	Parameter1=Insert Position No. 2bytes (ASCII system extended to 4 bytes) Parameter2=TrackNo. 2bytes specification (ASCII system extended to 4 bytes)
	PRG RMV XXXX	5	13	Number	-	Remove Position No. 2bytes specification
	SET CUR FDR XXXX	5	17	Name String	-	Folder Name String specification
	SET CUR FDR FWD	5	18	-	-	-
	SET CUR FDR REV	5	19	-	-	-
	SET CUR FIL XXXX	5	20	Name String	-	File Name String specification
	PITCH SW XXXX	5	21	Number	-	Pitch switch Value 1byte specification ON:1/OFF:0
	PITCH VAL XXXX	5	22	Number	-	Pitch Value 6 digit specification However, the pitch value is converted to ASCII code by multiplying each digit by 100. Be sure that each digit uses 2 bytes each as a result of conversion to the ASCII code. 1st digit Symbol = 0: positive/1: negative 2nd digit Pitch hundred value (0 - 9) 3rd digit Pitch ten value (0 - 9) 4th digit Pitch single value (0 - 9) 5th digit Pitch first decimal value (0 - 9) 6th digit Pitch second decimal value (0 - 9) Transmission from the 1st digit.
	KEY SW	5	25	Number	-	Key Sw Value 1byte ON:1/OFF:0
	PITCH UP LOW	5	27	-	-	Pitch Value is +0.1%.
	PITCH UP MID	5	28	-	-	Pitch Value is +0.7%.
	PITCH UP HI	5	29	-	-	Pitch Value is +1.3%.
	PITCH DN LOW	5	30	-	-	Pitch Value is -0.1%.
	PITCH DN MID	5	31	-	-	Pitch Value is -0.7%.
	PITCH DN HI	5	32	-	-	Pitch Value is -1.3%.
	SET AB XXXX YYYY	5	33	TIME STRING.	TIME STRING.	

Category	Command	Command code		Parameter 1	Parameter 2	Remarks
		Category code	Command number			
Device setting	DIMMER XXXX	7	1	Number	-	Dimmer Value 1byte specification
	LOCK XXXX	7	2	Number	-	Lock No. 1byte specification
	PRESET XXXX YYYY	7	3	Number	Number	Parameter1=Preset Index 1byte Parameter2=Preset Value 4Bytes
	PRESET ALL CHG	7	4	Number	-	Preset Value Table 24×4bytes
	PRESET DEF	7	5	-	-	-
	PRESET LOAD	7	6	Name String	-	Preset File Name String
	PRESET SAVE	7	7	Name String	-	Preset File Name String
	SYSCFG XXXX YYYY	7	10	Number	Number	Parameter1=SYSCFG Index 1byte Parameter2=SYSCFG Value 4Bytes
	SYSCFG ALL CHG	7	11	Number	-	SYSCFG Value Table 21 × 4Bytes
	SYSCFG DEF	7	12	-	-	-

□ Status request command

Category	Command	Command code		Parameter 1	Parameter 2	Remarks
		Category code	Command number			
Playback status	GET TRP STAT	9	1	-	-	-
	GET CUR FDR	9	2	-	-	-
	GET ELP TIME	9	3	-	-	-
	GET REM TIME	9	4	-	-	-
	GET CUR FILE	9	5	-	-	-
	GET CUR TRK	9	6	-	-	-
	GET CUR IDX	9	7	-	-	-
	GET CUR SIZE	9	8	-	-	-
	GET CUR LEN	9	9	-	-	-
	GET CUR TITL	9	10	-	-	-
	GET CUR ART	9	11	-	-	-
	GET CUR ALBM	9	12	-	-	-
	GET CUR CH	9	13	-	-	-
	GET CUR FMT	9	14	-	-	-
	GET CUR SMP	9	15	-	-	-
	GET TAT TTL	9	16	-	-	-
	GET TAT FIL XXXX	9	17	Number	-	Track No. 2 bytes specification (ASCII system extended to 4 bytes)
	GET CUE FILE	9	18	-	-	-
	GET CUE TRK	9	19	-	-	-
	GET CUE TIME	9	20	-	-	-
	GET HOT NO	9	21	-	-	-
	GET HOT FILE	9	22	-	-	-
	GET HOT FILE XXXX	9	23	Number	-	Hot No. 1byte specification
	GET HOT IN XXXX	9	24	Number	-	Hot No. 1byte specification
	GET PRG NO	9	28	-	-	-
	GET PRG FILE	9	29	-	-	-
	GET PRG FILE XXXX	9	30	Number	-	Program No. 2 bytes specification (ASCII system extended to 4 bytes)
	GET PRG TTL	9	31	-	-	-
	GET TRP DIR	9	33	-	-	-
	GET TRP SPD	9	34	-	-	-

Category	Command	Command code		Parameter 1	Parameter 2	Remarks
		Category code	Command number			
Device status	GET POW STAT	11	1	-	-	-
	GET WIN STAT	11	2	-	-	-
	GET DIM STAT	11	3	-	-	-
	GET LOK STAT	11	4	-	-	-
	GET PITCH STAT	11	5	-	-	-
	GET PITCH VAL	11	6	-	-	-
	GET KEY STAT	11	7	-	-	-
	GET PRS XXXX	11	8	Number	-	Preset Item Number specification
	GET UBL VOL	11	9	-	-	-
	GET FW VER	11	10	-	-	-
	GET DRV VER	11	11	-	-	-
	GET PPWD	11	14	-	-	-
	GET AVAILABLE PSTAT	11	15	-	-	Inquiry about transferable power status.
	GET CUR MEDIA	11	18	-	-	Inquiry of current media
GET ALV XXXX	11	19	Number	-	SYSCFG Value Table Number 2 bytes specification (ASCII system extended to 4 bytes)	
Get list	GET MEDIA LST	13	1	-	-	-
	GET MEDIA TTL	13	2	-	-	-
	GET MEDIA XXXX	13	3	Number	-	Media No. 2 bytes specification (ASCII system extended to 4 bytes)
	GET FDR LST XXXX	13	7	Number	-	Folder No. 2 bytes specification (ASCII system extended to 4 bytes)
	GET FDR TTL XXXX	13	8	Number	-	Folder No. 2 bytes specification (ASCII system extended to 4 bytes)
	GET FDR XXXX YYYY	13	9	Number	Number	Folder No. 2 bytes specification (ASCII system extended to 4 bytes)
	GET SND LST XXXX	13	10	Number	-	List No. 2 bytes specification (ASCII system extended to 4 bytes)
	GET SND TTL XXXX	13	11	Number	-	List No. 2 bytes specification (ASCII system extended to 4 bytes)
	GET SND XXXX YYYY	13	12	Number	Number	List No. 2 bytes specification (ASCII system extended to 4 bytes)
	GET M3U LST XXXX	13	13	Number	-	Folder No. 2 bytes specification (ASCII system extended to 4 bytes)
	GET M3U TTL XXXX	13	14	Number	-	Folder No. 2 bytes specification (ASCII system extended to 4 bytes)
	GET M3U XXXX YYYY	13	15	Number	Number	Parameter1=Folder No. 2bytes (ASCII system extended to 4 bytes) Parameter2=M3U No. 2bytes specification (ASCII system extended to 4 bytes)
	GET PPL LST XXXX	13	16	-	-	-
	GET PPL TTL XXXX	13	17	Number	-	Folder No. 2 bytes specification (ASCII system extended to 4 bytes)
GET PPL XXXX YYYY	13	18	Number	Number	Parameter1=Folder No. 2bytes (ASCII system extended to 4 bytes) Parameter2=PPL No. 2bytes specification (ASCII system extended to 4 bytes)	

□ Status notification command

Category	Command	Command code		Parameter 1	Parameter 2	Remarks
		Category code	Command number			
Playback status	ANS TRP STAT*	9	60	Number	-	0 : TSTA_STOP 1:TSTA_CUE 2:TSTA_CUE_EXECUTING 3:TSTA_PAUSE 4 : TSTA_AUD_PAUSE 5:TSTA_SEARCH FWD 6:TSTA_SEARCH_BWD 7 : TSTA_PLAY
	ANS CUR FDR	9	61	Name String	-	Current Folder Name String reply
	ANS ELP TIME*	9	62	TIME STRING.	-	TIME STRING reply
	ANS REM TIME*	9	63	TIME STRING.	-	TIME STRING reply
	ANS CUR FILE	9	64	Name String	-	Folder Name String reply
	ANS CUR TRK*	9	65	Number	-	Current Track Number reply
	ANS CUR IDX*	9	66	Number	-	Current Index Number reply
	ANS CUR SIZE	9	67	Number	-	Current Track Size reply
	ANS CUR LEN	9	68	TIME STRING.	-	TIME STRING reply of total Current Track time
	ANS CUR TITL	9	69	Name String	-	Current Track Title Name String reply
	ANS CUR ART	9	70	Name String	-	Current Track Artist Name String reply
	ANS CUR ALBM	9	71	Name String	-	Current Track Album Name String reply
	ANS CUR CH	9	72	Number	-	Current Track Channel Number reply
	ANS CUR FMT	9	73	Name String	-	Current Track Audio Format String reply
	ANS CUR SMP	9	74	Number	-	Current Track Sample Rate 2byte reply
	ANS TAT TTL	9	75	Number	-	Total Track Number 2 byte reply
	ANS TAT FIL XXXX	9	76	Name String	-	File Name String reply of specified Track No.
	ANS CUE FILE	9	77	Name String	-	Current Track File Name String reply
	ANS CUE TRK	9	78	Name String	-	Cue File Name String reply
	ANS CUE TIME	9	79	TIME STRING.	-	Cue TIME STRING reply
	ANS HOT NO	9	80	Number	-	Hot No. 1byte reply
	ANS HOT FILE	9	81	Name String	-	Hot Playing File Name String reply
	ANS HOT FILE XXXX	9	82	Name String	-	Hot No. File Name String reply
	ANS HOT IN XXXX	9	83	TIME STRING.	-	Hot No. Start TIME STRING reply
	ANS PRG NO	9	87	Number	-	Current Playing Program No. 2 byte reply
	ANS PRG FILE	9	88	Name String	-	Current Playing File Name String reply
	ANS PRG FILE XXXX	9	89	Name String	-	Program No. File Name String reply
	ANS PRG TTL	9	90	Number	-	Total Program number 2 bytes reply
	ANS METER VALUE*	9	91	Number	-	MS4Bytes=Rch,LS4Byte=Lch =8bytesMeterValue reply
	ANS TRP DIR	9	92	Number	-	0: FWD/1:REV
	ANS TRP SPD	9	93	Number	-	Value of speed scale x 10.

Category	Command	Command code		Parameter 1	Parameter 2	Remarks
		Category code	Command number			
Device status	ANS POW STAT*	11	60	Number	-	GET POW STAT 1byte reply 0:POWER ON 1:POWER NEUTRAL 2:POWER STANDBY
	ANS WIN STAT	11	61	Number	-	
	ANS DIM STAT*	11	62	Number	-	Dimmer Value 1byte reply
	ANS LOK STAT*	11	63	Number	-	Lock No. 1byte specification
	ANS PITCH STAT*	11	64	Number	-	Pitch switch Value 1byte reply ON:1/OFF:0
	ANS PITCH VAL*	11	65	Number	-	Pitch Value 5bytes specification Byte1 symbol =0:positive/1:negative Byte2 Pitch hundred value (0 - 9) Byte3 Pitch ten value (0 - 9) Byte4 Pitch single value (0 - 9) Byte5 Pitch first decimal value (0 - 9)
	ANS KEY STAT	11	66	Number	-	Key Sw Value 1byte ON:1/OFF:0 reply
	ANS PRS XXXX	11	67	Number	-	Preset Value 4bytes reply
	ANS UBL VOL	11	68	Number	-	Volume Value 4bytes reply Byte1 symbol =0:positive/1:negative Byte2 Volume(db) ten value (0 - 9) Byte3 Volume(db) single value (0 - 9) Byte4 Volume(db) first decimal value (0 - 9) Byte5 Volume(db) first decimal value (0 - 9)
	ANS FW VER	11	69	Number	-	Version No. reply
	ANS DRV VER	11	70	Number	-	Optical Drive Version No. reply
	ANS PPWD	11	73	Name String	-	Password string reply
	ANS ERROR*	11	74	Number	-	Error Code
	ANS AVAILABLE PSTAT	11	75	Number	-	Transferable power status indicated in 2 bytes Bit Pattern bit0: Power OFF bit1: Power ON bit2: Power Neutral bit3: Network Standby bit4: Standby
	ANS CUR MEDIA	11	78	String	-	Return current media. Within 16 characters. E.g.) CD USB1 USB2 iPod/iPhone
ANS ALV XXXX	11	79	Number	-	SYSCFG Setting value	

Category	Command	Command code		Parameter 1	Parameter 2	Remarks
		Category code	Command number			
Get list	ANS MEDIA TTL	13	61	Number	-	Media List Total No. 2bytes reply
	ANS MEDIA XXXX	13	62	Name String	-	Media Name String reply of Media List Index No.
	ANS FDR TTL XXXX	13	67	Number	-	Total Folder Number 2 bytes reply
	ANS FDR XXXX YYYY	13	68	Name String	-	Folder No. Folder Name String reply
	ANS SND TTL XXXX	13	70	Number	-	Total Sound File Number 2 bytes reply
	ANS SND XXXX YYYY	13	71	Name String	-	Track No. File Name String reply
	ANS M3U TTL XXXX	13	73	Number	-	Total M3U File Number 2 bytes reply
	ANS M3U XXXX YYYY	13	74	Name String	-	File Name String reply
	ANS PPL TTL XXXX	13	76	Number	-	Total PPL File Number 2 bytes reply
ANS PPL XXXX YYYY	13	77	Name String	-	File Name String reply	

□ D&M RC Communication format

Control Command List

Description		Command	Remarks
KEY Control	Standby	@02312'¥r'	
	PowerON	@023PW'¥r'	
	PLAY	@02353'¥r'	
	STOP	@02354'¥r'	
	PAUSE	@02348'¥r'	
	RWD	@02350'¥r'	
	FF	@02352'¥r'	
	Track Jump	nnnn @0Trnnnn'¥r'	
	Track Jump >>	@02332'¥r'	
	Track Jump <<	@02333'¥r'	
	SKIP BACK	@023SB'¥r'	
	END MONITOR	@023EM'¥r'	
	HOT START PLAY	Hot Start No. nn @0HPnn'¥r'	nn : Hot Start No. (nn=01~20)
	HOT START CUE UP	Hot Start No. nn @0HCnn'¥r'	nn : Hot Start No. (nn=01~20)
	Frame	@0frON'¥r'	
	Frame +	@0fr00'¥r'	
Frame -	@0fr01'¥r'		
Hot Start List Store	@0HSSR'¥r'		
File List	Select Folder	xxxx @0Sfxxxx'¥r'	xxxx : Folder No.
	HotStart Set	@0hsnnNNNNNNN'¥r'	nn: Hot Start No. NNNNNNN : The full path.

Status Command List

Status request command (host → this unit)		Status message (this unit → host)			Remarks
Request.	Command	Ans.	Command		
Status	Power Status	@0?PW'¥r'	Power Mode	On	@0PW00'¥r'
			Standby	@0PW01'¥r'	
	Disc/USB Storage	@0?CD '¥r'	Disc	No Disc/USB Storage	@0CDNC'¥r'
				Disc/USB Storage In	@0CDCI'¥r'
	Status	@0?ST'¥r'	STOP	STOP	@0STST'¥r'
				Cue	@0STCE'¥r'
			Play	AutoCue	@0STAC'¥r'
				PLAY	@0STPL'¥r'
				PLAYPAUSE	@0STPP'¥r'
				REPEAT PLAY PAUSE	@0STPR'¥r'
				FF	@0STFF'¥r'
				RWD	@0STRW'¥r'
			Others	A-B Repeat	@0STAB'¥r'
				Loading	@0STLD'¥r'
				Busy	@0STBY'¥r'
				File List	@0STFL'¥r'
TrackEdit/Preset				@0STED'¥r'	
Operation Error				@0STER'¥r'	

Status request command (host → this unit)			Status message (this unit → host)			Remarks		
Request.		Command	Ans.		Command			
Track, Key settings	Total Track Number		@0?Tt'¥r'		XXXX	@0TtXXXX'¥r'	4 digits	
	Track Number		@0?Tr'¥r'		XXXX	@0TrXXXX'¥r'	4 digits	
	HOT START PLAY No.	(xx : Hot Start No.)	@0?HP'¥r'	HOT START PLAY	XX	@0HPXX'¥r'	During HOT START playback for No.XX @0HPxx'¥r' Normally, during PLAY, STOP, etc. @0HP00'¥r'	
	Elapse Time		@0?ET'¥r'	Elapse Time	hhmmss	@0ETHhmmss'¥r'		
	Remain Time		@0?RM'¥r'	Remain Time	hhmmss	@0RMhmmss'¥r'		
	Select Folder		@0?SF'¥r'	Select Folder	DXXXXXXXXXXXX	@0SFDXXXXXXXXXXXX'¥r'	D: Drive No. (2 : USB, 3 : CD) XXXX... : Folder name (Max 256 characters) ex1. Root folder in USB storage @0SF2'¥r' ex2. ¥Folder01 in USB storage @0SF2/Folder01'¥r'	
	Folder Name	(NNNN : Folder No.)	@0?FnNNNN'¥r'	Folder Name	DXXXXXXXXXXXX	@0FnXXXXXXXXXXXX'¥r'	D : Drive No. (2 : USB, 3 : CD) XXXX... : Folder name of Folder No.NNNN (Max 256 characters)	
	Track Name	(xxxx : Track No.)	@0?tnxxxx'¥r'		XXXXXX	@0tnXXXXXX'¥r'		
	Track Size	(xxxx : Track No.)	@0?tsxxxx'¥r'			@0tsXXXXXX'¥r'		
	Total Folder Number		@0?Tf'¥r'	Total Folder Number		@0TfXXXX'¥r'		
	Play Track Algo/File	CH		@0?ch'¥r'	CH	STEREO	@0chST'¥r'	
		Algo		@0?af'¥r'	Algo	MONO	@0chMO'¥r'	
						PCM	@0afPMXX'¥r'	XX : The bit length
						MP3	@0afM3XXX'¥r'	XXX : bps
		FS		@0?fs'¥r'	FS	AAC	@0afACXXX'¥r'	XXX : bps
Artist			@0?at'¥r'	Artist	XX	@0fsXX'¥r'	XX is 48 for 48kHz, 44 for 44.1kHz, etc.	
Title		@0?ti'¥r'	Title	XXX	@0atXXX'¥r'	XXX... : Artist, Max 64 characters		
Album		@0?al'¥r'	Album	XXX	@0tiXXX'¥r'	XXX... : Title, Max 64 characters		
Hot Start Set	nn : Hot Start No.	@0?Hsnn'¥r'	Hot Start Set		@0alXXX'¥r'	XXX... : Album, Max 64 characters		
Program Play/ Nomal Play		@0?PG'¥r'	Program Play/ Nomal Play	Nomal Play	@0Hsnnxxxxx:HHHmms'¥r'	xxx... : The full path of Track “:” : separator HHHmms : Time		
				Program Play	@0PG00'¥r'			
					@0PG01'¥r'			

Dimensions

Unit: in. (mm)

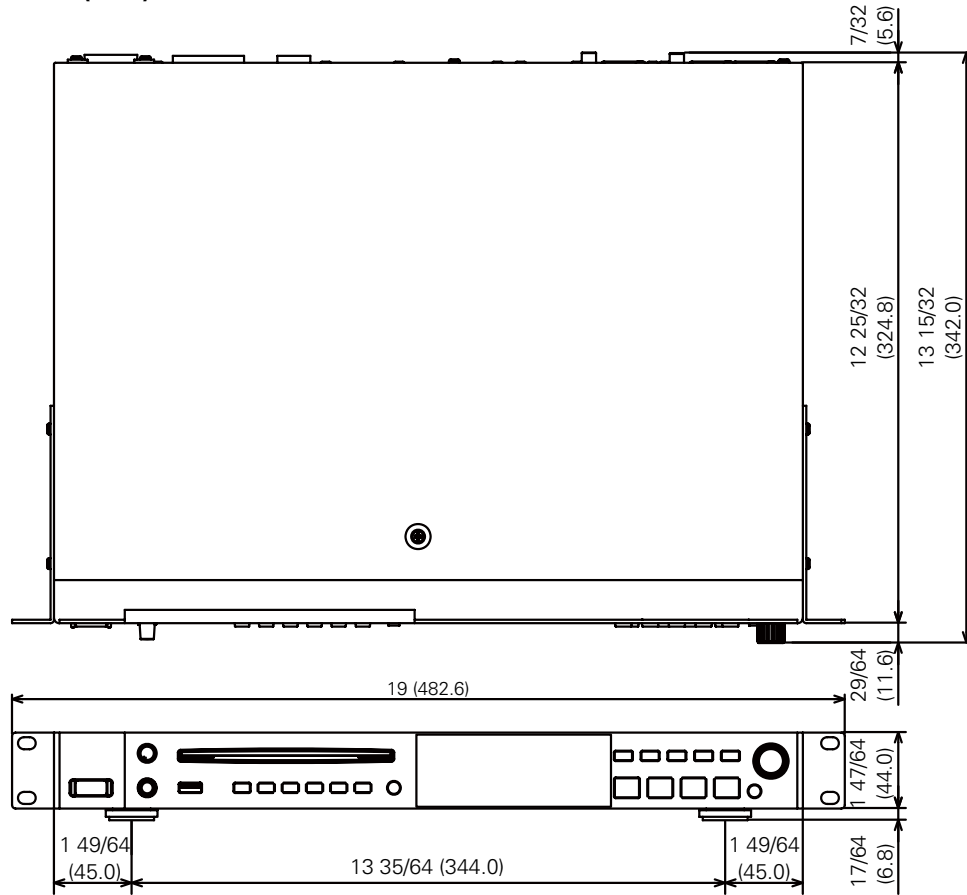

Weight: 8 lbs 13.10 oz (4.0 kg)

D&M Holdings Inc.