

DENON
PROFESSIONAL

SOLID STATE RECORDER

DN-F450R

Owner's Manual

IMPORTANT TO SAFETY

WARNING:

To reduce the risk of fire and electric shock, this apparatus should not be exposed to rain or moisture and objects filled with liquids, such as vases, should not be placed on this apparatus

CAUTION

1. Handle the power supply cord carefully

Do not damage or deform the power supply cord. If it is damaged or deformed, it may cause electric shock or malfunction when used. When removing from wall outlet, be sure to remove by holding the plug attachment and not by pulling the cord.

2. Do not open the rear cover

In order to prevent electric shock, do not open the top cover. If problems occur, contact your DENON DEALER.

3. Do not place anything inside

Do not place metal objects or spill liquid inside the system. Electric shock or malfunction may result.

Please, record and retain the Model name and serial number of your set shown on the rating label.

Model No. DN-F450R

Serial No. _____



CAUTION
RISK OF ELECTRIC SHOCK
DO NOT OPEN



CAUTION:

TO REDUCE THE RISK OF ELECTRIC SHOCK, DO NOT REMOVE COVER (OR BACK). NO USER-SERVICEABLE PARTS INSIDE. REFER SERVICING TO QUALIFIED SERVICE PERSONNEL.



The lightning flash with arrowhead symbol, within an equilateral triangle, is intended to alert the user to the presence of uninsulated "dangerous voltage" within the product's enclosure that may be of sufficient magnitude to constitute a risk of electric shock to persons.



The exclamation point within an equilateral triangle is intended to alert the user to the presence of important operating and maintenance (servicing) instructions in the literature accompanying the appliance.

CAUTION:

USE OF CONTROLS OR ADJUSTMENTS OR REFORMATION OF PROCEDURES OTHER THAN THOSE SPECIFIED HEREIN MAY RESULT IN HAZARDOUS RADIATION EXPOSURE.

FCC INFORMATION (For US customers)

1. COMPLIANCE INFORMATION

Product Name: SOLID STATE RECORDER

Model Number: DN-F450R

This product complies with Part 15 of the FCC Rules. Operation is subject to the following two conditions: (1) this product may not cause harmful interference, and (2) this product must accept any interference received, including interference that may cause undesired operation.

Denon Professional div. D&M Professional
1100 Maplewood Drive Itasca, IL 60143
Tel. 630-741-0330

2. IMPORTANT NOTICE: DO NOT MODIFY THIS PRODUCT

This product, when installed as indicated in the instructions contained in this manual, meets FCC requirements. Modification not expressly approved by DENON may void your authority, granted by the FCC, to use the product.

3. NOTE

This product has been tested and found to comply with the limits for a Class B digital device, pursuant to Part 15 of the FCC Rules. These limits are designed to provide reasonable protection against harmful interference in a residential installation.

This product generates, uses and can radiate radio frequency energy and, if not installed and used in accordance with the instructions, may cause harmful interference to radio communications. However, there is no guarantee that interference will not occur in a particular installation. If this product does cause harmful interference to radio or television reception, which can be determined by turning the product OFF and ON, the user is encouraged to try to correct the interference by one or more of the following measures:

- Reorient or relocate the receiving antenna.
- Increase the separation between the equipment and receiver.
- Connect the product into an outlet on a circuit different from that to which the receiver is connected.
- Consult the local retailer authorized to distribute this type of product or an experienced radio/TV technician for help.

This Class B apparatus complies with Canadian ICES-003.

Cet appareil numérique de la classe B est conforme à la norme NMB-003 du Canada.

IMPORTANT SAFETY INSTRUCTIONS

READ BEFORE OPERATING EQUIPMENT

This product was designed and manufactured to meet strict quality and safety standards. There are, however, some installation and operation precautions which you should be particularly aware of.

1. Read these instructions.
2. Keep these instructions.
3. Heed all warnings.
4. Follow all instructions.
5. Do not use this apparatus near water.
6. Clean only with dry cloth.
7. Do not block any ventilation openings. Install in accordance with the manufacturer's instructions.
8. Do not install near any heat sources such as radiators, heat registers, stoves, or other apparatus (including amplifiers) that produce heat.
9. Do not defeat the safety purpose of the polarized or grounding-type plug. A polarized plug has two blades with one wider than the other. A grounding type plug has two blades and a third grounding prong. The wide blade or the third prong are provided for your safety. If the provided plug does not fit into your outlet, consult an electrician for replacement of the obsolete outlet.
10. Protect the power cord from being walked on or pinched particularly at plugs, convenience receptacles, and the point where they exit from the apparatus.
11. Only use attachments/accessories specified by the manufacturer.
12. Use only with the cart, stand, tripod, bracket, or table specified by the manufacturer, or sold with the apparatus. When a cart is used, use caution when moving the cart/apparatus combination to avoid injury from tip-over.
13. Unplug this apparatus during lightning storms or when unused for long periods of time.
14. Refer all servicing to qualified service personnel. Servicing is required when the apparatus has been damaged in any way, such as power-supply cord or plug is damaged, liquid has been spilled or objects have fallen into the apparatus, the apparatus has been exposed to rain or moisture, does not operate normally, or has been dropped.
15. Batteries shall not be exposed to excessive heat such as sunshine, fire or the like.



CAUTION: (English)

To completely disconnect this product from the mains, disconnect the plug from the wall socket outlet. The mains plug is used to completely interrupt the power supply to the unit and must be within easy access by the user. Do not expose batteries to excessive heat such as sunshine, fire or the like.

VORSICHT: (Deutsch)

Um dieses Gerät vollständig von der Stromversorgung abzutrennen, trennen Sie bitte den Netzstecker von der Wandsteckdose ab. Die Hauptstecker werden verwendet, um die Stromversorgung zum Gerät völlig zu unterbrechen; er muss für den Benutzer gut und einfach zu erreichen sein. Setzen Sie Batterien nicht übermäßiger Wärme aus, z. B. Sonnenstrahlung, Feuer oder dergleichen.

PRECAUTION: (Français)

Pour déconnecter complètement ce produit du courant secteur, débranchez la prise de la prise murale. La prise secteur est utilisée pour couper complètement l'alimentation de l'appareil et l'utilisateur doit pouvoir y accéder facilement. N'exposez pas les batteries à une chaleur excessive telle que le soleil, le feu ou autre.

ATTENZIONE: (Italiano)

Per scollegare definitivamente questo prodotto dalla rete di alimentazione elettrica, togliere la spina dalla relativa presa. La spina di rete viene utilizzata per interrompere completamente l'alimentazione all'unità e deve essere facilmente accessibile all'utente. Non esporre le batterie a un calore eccessivo, per esempio al sole, al fuoco o altre fonti.

PRECAUCIÓN: (Español)

Para desconectar completamente este producto de la alimentación eléctrica, desconecte el enchufe del enchufe de la pared. El enchufe de la alimentación se utiliza para interrumpir por completo el suministro de alimentación a la unidad y debe de encontrarse en un lugar al que el usuario tenga fácil acceso. No exponga las pilas a calor excesivo, como a la luz solar, el fuego, etc.

VOORZICHTIGHEID: (Nederlands)

Om de voeding van dit product volledig te onderbreken moet de stekker uit het stopcontact worden getrokken. De netstekker wordt gebruikt om de stroomtoevoer naar het toestel volledig te onderbreken en moet voor de gebruiker gemakkelijk bereikbaar zijn. Stel de batterijen niet bloot aan felle zonneschijn, brand, enzovoorts.

FÖRSIKTIHETSMÅTT: (Svenska)

Koppla loss stickproppen från eluttaget för att helt skilja produkten från nätet. Stickproppen används för att helt bryta strömförsörjningen till apparaten, och den måste vara lättillgänglig för användaren. Utsätt inte batterierna för stark hetta såsom solsken, eld eller liknande.

ATENÇÃO: (Português)

Para desligar completamente este produto da corrente, desligue a ficha da tomada eléctrica. A ficha eléctrica é utilizada para interromper completamente a alimentação da unidade e deve estar num local onde o utilizador lhe possa aceder facilmente. Não exponha as pilhas a fontes de calor excessivo, como luz solar, fogo ou semelhantes.

NOTE ON USE / HINWEISE ZUM GEBRAUCH

WARNINGS	WARNHINWEISE
<ul style="list-style-type: none"> • Avoid high temperatures. Allow for sufficient heat dispersion when installed in a rack. • Handle the power cord carefully. Hold the plug when unplugging the cord. • Keep the unit free from moisture, water, and dust. • Unplug the power cord when not using the unit for long periods of time. • Do not obstruct the ventilation holes. • Do not let foreign objects into the unit. • Do not let insecticides, benzene, and thinner come in contact with the unit. • Never disassemble or modify the unit in any way. • Ventilation should not be impeded by covering the ventilation openings with items, such as newspapers, tablecloths or curtains. • Naked flame sources such as lighted candles should not be placed on the unit. • Observe and follow local regulations regarding battery disposal. • Do not expose the unit to dripping or splashing fluids. • Do not place objects filled with liquids, such as vases, on the unit. • Do not handle the mains cord with wet hands. • When the switch is in the OFF position, the equipment is not completely switched off from MAINS. • The equipment shall be installed near the power supply so that the power supply is easily accessible. 	<ul style="list-style-type: none"> • Vermeiden Sie hohe Temperaturen. Beachten Sie, dass eine ausreichende Belüftung gewährleistet wird, wenn das Gerät auf ein Regal gestellt wird. • Gehen Sie vorsichtig mit dem Netzkabel um. Halten Sie das Kabel am Stecker, wenn Sie den Stecker herausziehen. • Halten Sie das Gerät von Feuchtigkeit, Wasser und Staub fern. • Wenn das Gerät längere Zeit nicht verwendet werden soll, trennen Sie das Netzkabel vom Netzstecker. • Decken Sie den Lüftungsbereich nicht ab. • Lassen Sie keine fremden Gegenstände in das Gerät kommen. • Lassen Sie das Gerät nicht mit Insektiziden, Benzin oder Verdünnungsmitteln in Berührung kommen. • Versuchen Sie niemals das Gerät auseinander zu nehmen oder zu verändern. • Die Belüftung sollte auf keinen Fall durch das Abdecken der Belüftungsöffnungen durch Gegenstände wie beispielsweise Zeitungen, Tischtücher, Vorhänge o. Ä. behindert werden. • Auf dem Gerät sollten keinerlei direkte Feuerquellen wie beispielsweise angezündete Kerzen aufgestellt werden. • Bitte beachten Sie bei der Entsorgung der Batterien die örtlich geltenden Umweltbestimmungen. • Das Gerät sollte keiner tropfenden oder spritzenden Flüssigkeit ausgesetzt werden. • Auf dem Gerät sollten keine mit Flüssigkeit gefüllten Behälter wie beispielsweise Vasen aufgestellt werden. • Das Netzkabel nicht mit feuchten oder nassen Händen anfassen. • Wenn der Schalter ausgeschaltet ist (OFF-Position), ist das Gerät nicht vollständig vom Stromnetz (MAINS) abgetrennt. • Das Gerät sollte in der Nähe einer Netzsteckdose aufgestellt werden, damit es leicht an das Stromnetz angeschlossen werden kann.

☐ OBSERVATIONS RELATIVES A L'UTILISATION / NOTE SULL'USO / NOTAS SOBRE EL USO / ALVORENS TE GEBRUIKEN / OBSERVERA / NOTA SOBRE UTILIZAÇÃO

AVERTISSEMENTS	AVVERTENZE	ADVERTENCIAS	WAARSCHUWINGEN	VARNINGAR	AVISOS
<ul style="list-style-type: none"> • Eviter des températures élevées. Tenir compte d'une dispersion de chaleur suffisante lors de l'installation sur une étagère. • Manipuler le cordon d'alimentation avec précaution. Tenir la prise lors du débranchement du cordon. • Protéger l'appareil contre l'humidité, l'eau et la poussière. • Débrancher le cordon d'alimentation lorsque l'appareil n'est pas utilisé pendant de longues périodes. • Ne pas obstruer les trous d'aération. • Ne pas laisser des objets étrangers dans l'appareil. • Ne pas mettre en contact des insecticides, du benzène et un diluant avec l'appareil. • Ne jamais démonter ou modifier l'appareil d'une manière ou d'une autre. • Ne pas recouvrir les orifices de ventilation avec des objets tels que des journaux, nappes ou rideaux. Cela entraverait la ventilation. • Ne jamais placer de flamme nue sur l'appareil, notamment des bougies allumées. • Veillez à respecter les lois en vigueur lorsque vous jetez les piles usagées. • L'appareil ne doit pas être exposé à l'eau ou à l'humidité. • Ne pas poser d'objet contenant du liquide, par exemple un vase, sur l'appareil. • Ne pas manipuler le cordon d'alimentation avec les mains mouillées. • Lorsque l'interrupteur est sur la position OFF, l'appareil n'est pas complètement déconnecté du SECTEUR (MAINS). • L'appareil sera installé près de la source d'alimentation, de sorte que cette dernière soit facilement accessible. 	<ul style="list-style-type: none"> • Evitate di esporre l'unità a temperature elevate. Assicuratevi che vi sia un'adeguata dispersione del calore quando installate l'unità in un mobile per componenti audio. • Maneggiare il cavo di alimentazione con attenzione. Tenete ferma la spina quando scollegate il cavo dalla presa. • Tenete l'unità lontana dall'umidità, dall'acqua e dalla polvere. • Scollegate il cavo di alimentazione quando prevedete di non utilizzare l'unità per un lungo periodo di tempo. • Non coprite i fori di ventilazione. • Non inserite corpi estranei all'interno dell'unità. • Assicuratevi che l'unità non entri in contatto con insetticidi, benzolo o solventi. • Non smontate né modificate l'unità in alcun modo. • Le aperture di ventilazione non devono essere ostruite coprendole con oggetti, quali giornali, tovaglie, tende e così via. • Non posizionate sull'unità fi amme libere, come ad esempio candele accese. • Prestate attenzione agli aspetti legati alla tutela dell'ambiente nello smaltimento delle batterie. • L'apparecchiatura non deve essere esposta a gocciolii o spruzzi. • Non posizionate sull'unità alcun oggetto contenente liquidi, come ad esempio i vasi. • Non toccare il cavo di alimentazione con le mani bagnate. • Quando l'interruttore è nella posizione OFF, l'apparecchiatura non è completamente scollegata da MAINS. • L'apparecchio va installato in prossimità della fonte di alimentazione, in modo che quest'ultima sia facilmente accessibile. 	<ul style="list-style-type: none"> • Evite altas temperaturas. Permite la suficiente dispersión del calor cuando está instalado en la consola. • Maneje el cordón de energía con cuidado. Sostenga el enchufe cuando desconecte el cordón de energía. • Mantenga el equipo libre de humedad, agua y polvo. • Desconecte el cordón de energía cuando no utilice el equipo por mucho tiempo. • No obstruya los orificios de ventilación. • No deje objetos extraños dentro del equipo. • No permita el contacto de insecticidas, gasolina y diluyentes con el equipo. • Nunca desarme o modifique el equipo de ninguna manera. • La ventilación no debe quedar obstruida por haberse cubierto las aperturas con objetos como periódicos, manteles o cortinas. • No deberán colocarse sobre el aparato fuentes inflamables sin protección, como velas encendidas. • A la hora de deshacerse de las pilas, respete la normativa para el cuidado del medio ambiente. • No exponer el aparato al goteo o salpicaduras cuando se utilice. • No colocar sobre el aparato objetos llenos de líquido, como jarros. • No maneje el cable de alimentación con las manos mojadas. • Cuando el interruptor está en la posición OFF, el equipo no está completamente desconectado de la alimentación MAINS. • El equipo se instalará cerca de la fuente de alimentación de manera que resulte fácil acceder a ella. 	<ul style="list-style-type: none"> • Vermijd hoge temperaturen. Zorg er bij installatie in een audiorack voor, dat de door het toestel geproduceerde warmte goed kan worden afgevoerd. • Hanteer het netsnoer voorzichtig. Houd het snoer bij de stekker vast wanneer deze moet worden aan- of losgekoppeld. • Laat geen vochtigheid, water of stof in het apparaat binnendringen. • Neem altijd het netsnoer uit het stopcontact wanneer het apparaat gedurende een lange periode niet wordt gebruikt. • De ventilatieopeningen mogen niet worden geblokkeerd. • Laat geen vreemde voorwerpen in dit apparaat vallen. • Voorkom dat insecticiden, benzeen of verfdunner met dit toestel in contact komen. • Dit toestel mag niet gedemonteerd of aangepast worden. • De ventilatie mag niet worden belemmerd door de ventilatieopeningen af te dekken met bijvoorbeeld kranten, een tafelleed of gordijnen. • Plaats geen open vlammen, bijvoorbeeld een brandende kaars, op het apparaat. • Houd u steeds aan de milieuvoorschriften wanneer u gebruikte batterijen wegdoet. • Stel het apparaat niet bloot aan druppels of spatten. • Plaats geen voorwerpen gevuld met water, bijvoorbeeld een vaas, op het apparaat. • Raak het netsnoer niet met natte handen aan. • Als de schakelaar op OFF staat, is het apparaat niet volledig losgekoppeld van de netspanning (MAINS). • De apparatuur wordt in de buurt van het stopcontact geïnstalleerd, zodat dit altijd gemakkelijk toegankelijk is. 	<ul style="list-style-type: none"> • Undvik höga temperaturer. Se till att det finns möjlighet till god värmeavledning vid montering i ett rack. • Hantera nätkabeln varsamt. Håll i kabeln när den kopplas från el-uttaget. • Utsätt inte apparaten för fukt, vatten och damm. • Koppla loss nätkabeln om apparaten inte kommer att användas i lång tid. • Tapp inte till ventilationsöppningarna. • Se till att främmande föremål inte tränger in i apparaten. • Se till att inte insektsmedel på spraybruk, bensens och thinner kommer i kontakt med apparatens hölje. • Ta inte isär apparaten och försök inte bygga om den. • Ventilationen bör inte förhindras genom att täcka för ventilationsöppningarna med föremål såsom tidningar, bordssdukar eller gardiner. • Placera inte öppen eld, t.ex. tända ljus, på apparaten. • Tänk på miljöaspekterna när du bortskaffar batterier. • Apparaten får inte utsättas för vätska. • Placera inte föremål fyllda med vätska, t.ex. vaser, på apparaten. • Hantera inte nåtsladden med våta händer. • Även om strömbrytaren står i det avstängda läget OFF, så är utrustningen inte helt bortkopplad från det elektriska nätet (MAINS). • Utrustningen ska vara installerad nära strömuttaget så att strömförsörjningen är lätt att tillgå. 	<ul style="list-style-type: none"> • Evite temperaturas altas. Assegure uma suficiente dispersão de calor quando a unidade for instalada numa prateleira. • Manuseie o cabo de alimentação com cuidado. Puxe pela ficha quando desligar o cabo de alimentação. • Mantenha a unidade afastada da humidade, da água e do pó. • Desligue o cabo de alimentação quando não estiver a utilizar a unidade por longos períodos de tempo. • Não obstrua os orifícios de ventilação. • Não deixe objectos estranhos dentro da unidade. • Não permita que insecticidas, benzina e diluente entrem em contacto com a unidade. • Nunca desmonte ou modifique de alguma forma a unidade. • A ventilação não deve ser obstruída, tapando as aberturas de ventilação com objectos, como jornais, toalhas ou cortinas. • Não devem ser colocadas junto à unidade fontes de chama aberta, como velas acesas. • Respeite as regulamentações locais relativas à eliminação de pilhas. • Não exponha a unidade a gotejamento ou salpicos de líquidos. • Não coloque objectos com líquidos, como jarros, em cima da unidade. • Não manuseie o cabo de alimentação com as mãos molhadas. • Quando o interruptor se encontra na posição OFF, o equipamento não está completamente desligado da REDE ELÉCTRICA. • O equipamento deve ser instalado junto da fonte de alimentação, para que a fonte de alimentação esteja facilmente acessível.

CAUTION

- The ventilation should not be impeded by covering the ventilation openings with items, such as newspapers, tablecloths, curtains, etc.
- No naked flame sources, such as lighted candles, should be placed on the apparatus.
- Attention should be drawn to the environmental aspects of battery disposal.
- The apparatus shall not be exposed to dripping or splashing for use.
- No objects filled with liquids, such as vases, shall be placed on the apparatus.

•DECLARATION OF CONFORMITY

(English)

We declare under our sole responsibility that this product, to which this declaration relates, is in conformity with the following standards:

EN60950-1, EN55022, EN55024, EN61000-3-2 and EN61000-3-3.

Following the provisions of Low Voltage Directive 2006/95/EC and EMC Directive 2004/108/EC, the EC regulation 1275/2008 and its frame work Directive 2009/125/EC for Energy-related Products (ErP).

•ÜBEREINSTIMMUNGSERKLÄRUNG

(Deutsch)

Wir erklären unter unserer Verantwortung, daß dieses Produkt, auf das sich diese Erklärung bezieht, den folgenden Standards entspricht:

EN60950-1, EN55022, EN55024, EN61000-3-2 und EN61000-3-3.

Gemäß den Bestimmungen der Niederspannungsrichtlinie 2006/95/EG und EMV Richtlinie 2004/108/EG, der Verordnung (EG) Nr. 1275/2008 der Kommission und deren Rahmenrichtlinie 2009/125/EG zu energieverbrauchsrelevanten Produkten (ErP).

•DECLARATION DE CONFORMITE

(Français)

Nous déclarons sous notre seule responsabilité que l'appareil, auquel se réfère cette déclaration, est conforme aux standards suivants:

EN60950-1, EN55022, EN55024, EN61000-3-2 et EN61000-3-3.

Selon la directive 2006/95/EC concernant la basse tension et la directive CEM 2004/108/EC, la réglementation européenne 1275/2008 et la directive 2009/125/EC établissant un cadre de travail applicable aux produits liés à l'énergie (ErP).

•DICHIARAZIONE DI CONFORMITÀ

(Italiano)

Dichiariamo con piena responsabilità che questo prodotto, al quale la nostra dichiarazione si riferisce, è conforme alle seguenti normative:

EN60950-1, EN55022, EN55024, EN61000-3-2 e EN61000-3-3.

Facendo seguito alle disposizioni della direttiva sul basso voltaggio 2006/95/EC alla direttiva EMC 2004/108/EC, alla norma EC 1275/2008 e alla relativa legge quadro 2009/125/EC in materia di prodotti alimentati ad energia (ErP).

QUESTO PRODOTTO E' CONFORME

AL D.M. 28/08/95 N. 548

•DECLARACIÓN DE CONFORMIDAD

(Español)

Declaramos bajo nuestra exclusiva responsabilidad que este producto al que hace referencia esta declaración, está conforme con los siguientes estándares:

EN60950-1, EN55022, EN55024, EN61000-3-2 y EN61000-3-3.

De acuerdo con la directiva sobre baja tensión 2006/95/CE y la directiva sobre CEM 2004/108/CE, la normativa CE 1275/2008 y su directiva marco 2009/125/EC para productos relacionados con la energía (ErP).

•EENVORMIGHEIDSVERKLARING

(Nederlands)

Wij verklaren uitsluitend op onze verantwoordelijkheid dat dit produkt, waarop deze verklaring betrekking heeft, in overeenstemming is met de volgende normen:

EN60950-1, EN55022, EN55024, EN61000-3-2 en EN61000-3-3.

Volgens de voorzieningen van lage spanningsrichtlijn 2006/95/EC en EMC-richtlijn 2004/108/EC, de EU-richtlijn 1275/2008 en de kaderrichtlijn 2009/125/EC voor energieverbruikende producten (ErP).

•ÖVERENSSTÄMMELSEINTYG

(Svenska)

Härmed intygas helt på eget ansvar att denna produkt, vilken detta intyg avser, uppfyller följande standarder:

EN60950-1, EN55022, EN55024, EN61000-3-2 och EN61000-3-3.

Uppfyller reglerna i lågspänningsdirektivet 2006/95/EC och EMC-direktivet 2004/108/EC, EU-förordningen 1275/2008 och ramverksdirektivet 2009/125/EC för energirelaterade produkter (ErP).

•DECLARAÇÃO DE CONFORMIDADE

(Português)

Declaramos sob nossa exclusiva responsabilidade que este produto, ao qual se refere esta declaração, se encontra em conformidade com as seguintes normas:

EN60950-1, EN55022, EN55024, EN61000-3-2 e EN61000-3-3.

De acordo com as provisões da Directiva de Baixa Tensão 2006/95/CE e a Directiva CEM 2004/108/CE, o Regulamento (CE) 1275/2008 e a respectiva Directiva-Quadro 2009/125/CE para produtos relacionados com o consumo de energia (ErP).

**D&M Professional Europe
Kingsbridge House
Padbury Oaks
Longford
Middlesex
UB7 0EH
UK**

A NOTE ABOUT RECYCLING:

This product's packaging materials are recyclable and can be reused. Please dispose of any materials in accordance with the local recycling regulations.
 When discarding the unit, comply with local rules or regulations.
 Batteries should never be thrown away or incinerated but disposed of in accordance with the local regulations concerning battery disposal.
 This product and the supplied accessories, excluding the batteries, constitute the applicable product according to the WEEE directive.

HINWEIS ZUM RECYCLING:

Das Verpackungsmaterial dieses Produktes ist zum Recyceln geeignet und kann wieder verwendet werden. Bitte entsorgen Sie alle Materialien entsprechend der örtlichen Recycling-Vorschriften.
 Beachten Sie bei der Entsorgung des Gerätes die örtlichen Vorschriften und Bestimmungen.
 Die Batterien dürfen nicht in den Hausmüll geworfen oder verbrannt werden; bitte entsorgen Sie die Batterien gemäß der örtlichen Vorschriften.
 Dieses Produkt und das im Lieferumfang enthaltene Zubehör (mit Ausnahme der Batterien!) entsprechen der WEEE-Direktive.

UNE REMARQUE CONCERNANT LE RECYCLAGE:

Les matériaux d'emballage de ce produit sont recyclables et peuvent être réutilisés. Veuillez disposer des matériaux conformément aux lois sur le recyclage en vigueur.
 Lorsque vous mettez cet appareil au rebut, respectez les lois ou réglementations en vigueur.
 Les piles ne doivent jamais être jetées ou incinérées, mais mises au rebut conformément aux lois en vigueur sur la mise au rebut des piles.
 Ce produit et les accessoires inclus, à l'exception des piles, sont des produits conformes à la directive DEEE.

NOTA RELATIVA AL RICICLAGGIO:

I materiali di imballaggio di questo prodotto sono riutilizzabili e riciclabili. Smaltire i materiali conformemente alle normative locali sul riciclaggio.
 Per lo smaltimento dell'unità, osservare le normative o le leggi locali in vigore.
 Non gettare le batterie, né incenerirle, ma smaltirle conformemente alla normativa locale sui rifiuti chimici.
 Questo prodotto e gli accessori inclusi nell'imballaggio sono applicabili alla direttiva RAEE, ad eccezione delle batterie.



Pb

ACERCA DEL RECICLAJE:

Los materiales de embalaje de este producto son reciclables y se pueden volver a utilizar. Disponga de estos materiales siguiendo los reglamentos de reciclaje de su localidad.
 Cuando se deshaga de la unidad, cumpla con las reglas o reglamentos locales.
 Las pilas nunca deberán tirarse ni incinerarse. Deberá disponer de ellas siguiendo los reglamentos de su localidad relacionados con los desperdicios químicos.
 Este producto junto con los accesorios empaquetados es el producto aplicable a la directiva RAEE excepto pilas.

EEN AANTEKENING MET BETREKKING TOT DE RECYCLING:

Het inpakmateriaal van dit product is recycleerbaar en kan opnieuw gebruikt worden. Er wordt verzocht om zich van elk afvalmateriaal te ontdoen volgens de plaatselijke voorschriften.
 Volg voor het wegdoen van de speler de voorschriften voor de verwijdering van wit- en bruingoed op.
 Batterijen mogen nooit worden weggegooid of verbrand, maar moeten volgens de plaatselijke voorschriften betreffende chemisch afval worden verwijderd.
 Op dit product en de meegeleverde accessoires, m.u.v. de batterijen is de richtlijn voor afgedankte elektrische en elektronische apparaten (WEEE) van toepassing.

OBSERVERA ANGÅENDE ÅTERTVINNING:

Produktens emballage är återvinningsbart och kan återanvändas. Kassera det enligt lokala återvinningsbestämmelser.
 När du kasserar enheten ska du göra det i överensstämmelse med lokala regler och bestämmelser.
 Batterier får absolut inte kastas i soporna eller brännas. Kassera dem enligt lokala bestämmelser för kemiskt avfall.
 Denna apparat och de tillbehör som levereras med den uppfyller gällande WEEE-direktiv, med undantag av batterierna.

UMA NOTA SOBRE A RECICLAGEM:

Os materiais de embalagem deste produto são recicláveis e podem ser reutilizados. Elimine quaisquer materiais de acordo com as normas de reciclagem locais.
 Quando eliminar a unidade, obedeça às regras ou normas locais.
 As pilhas nunca devem ser deitadas fora ou incineradas, mas sim eliminadas de acordo com as normas locais relativas aos resíduos químicos.
 Este produto e os respectivos acessórios embalados em conjunto constituem o produto aplicável de acordo com a directiva WEEE, excepto as pilhas.

Contents

Getting started	2
Main features	2
Accessories	2
Cautions on handling	2
Part names and functions	3
Front panel	3
Rear panel	4
Display	5
Switching the display.....	5
Display during stop status.....	5
Display during recording and recording pause.....	6
Display during playback and playback pause.....	6
Connections	7
Preparations	7
Cables used for audio connection.....	7
Audio connections	7
Analog connection (Unbalanced connection).....	7
Analog connection (Balanced connection).....	7
Connecting to a computer	7
Connecting the external control terminal	8
Remote terminal.....	8
RS-232C terminal.....	8
Connecting headphone	8
Connecting the AC adaptor	8
Mounting SD card	9
Inserting an SD card.....	9
Removing the SD Card.....	9
Cautions on SD card.....	9
Setting defaults	10
Menu list	10
Setting defaults	11
Menu operations.....	11
Settings for recording or playback (Presets).....	11
Display settings (Display)	14
Time & date settings (Time/Date)	14
Utility Function (Utility)	15
Checking the firmware version (F.W Version)	15

Recording	16
Selecting a folder to store recorded files	16
Recording	16
Operations during recording	17
Add a file during recording (Manual track).....	17
Adding marks (Marking).....	17
Recording time chart.....	18

Play	19
Selecting the folder to playback	19
Playback	19
Operations during playback	20
File switching (◀◀ ▶▶).....	20
Fast forward and fast rewind (Search ◀◀ ▶▶).....	20
Add marks (marking).....	20
Searching for Marks.....	20
Dividing a file.....	20

USB mode (Connection between DN-F450R) and the computer	21
--	----

Connecting to a computer	21
---------------------------------------	----

File/Folder settings	22
File menu	22
Playing back files (01 Play).....	22
File information (02 Information).....	22
Renaming files (03 Rename).....	22
Deleting files (04 Delete).....	23
Copying files (05 Copy).....	23
Moving files (06 Move).....	23
Deleting marks (07 Delete Mark).....	23
Folder menu	23
Selecting folders (1 Select).....	24
Creating folders (2 Make Folder).....	24
Renaming folders (3 Rename).....	24
Deleting folders (4 Delete).....	24
Other functions	25
Locking operation buttons (Key lock).....	25

Control function	26
REMOTE terminal 1	26
Wired remote switch operations.....	26
Cascade recording.....	26
REMOTE terminal 2	27
RS232C control	28
RS232C control.....	28

Information	40
Error messages	40
Troubleshooting	41

Specifications	42
-----------------------------	----

Index	43
--------------------	----

Getting started
Part names and functions
Connections
Setting defaults
Recording
Play
USB mode and the computer
File/Folder settings
Control function
Information
Specifications
Index

Getting started

Thank you for purchasing this DENON product. To ensure proper operation, please read this owner's manual carefully before using the product. After reading the manual, be sure to keep it for future reference.

Main features

- Stereo (2 channel) or monaural (1 channel) recording and playback
- Recording to various SD cards.
- 2 Types of recording format
 - Recording using MP3 (MPEG1 Layer III) audio compression format.
 - Recording using 16-bit Linear PCM format (uncompressed audio).
- Equipped with a level switching type balanced XLR connector for analog input.
- Computer compatibility (MS-DOS™, Windows, Macintosh compatible audio file)
- Automatic recording stops recording when there is no sound, and restarts recording when sound is detected (Silent Skip)
- Manual or automatic recording level control (ALC)
- Mark function makes specific search points without processing files
- Supports remote control operation from the two-line wired remote and RS-232C connections.
- Supplied with Windows application program DMP Mark Editor for editing the recorded files and marks.
- When two DN-F450R recorders are used, the Cascade recording function automatically continues recording on the other unit if there is no recording space remaining on the SD card.



SDHC Logo is a registered trademark.

Accessories

Check that the following parts are supplied with the product.

① Owner's manual	1
② AC adaptor	1
③ AC adaptor cord holder	1
④ Screw for fixing an AC adaptor cord holder	1
⑤ 19-inch rack mount brackets	2
⑥ Screws for attaching a 19-inch rack mount brackets	4
⑦ Audio cable	1
⑧ USB cable	1
⑨ CD-ROM	1
• DN-F450R Instruction manual	
• DMP Mark Editor Installer	
• DMP Mark Editor Instruction manual	

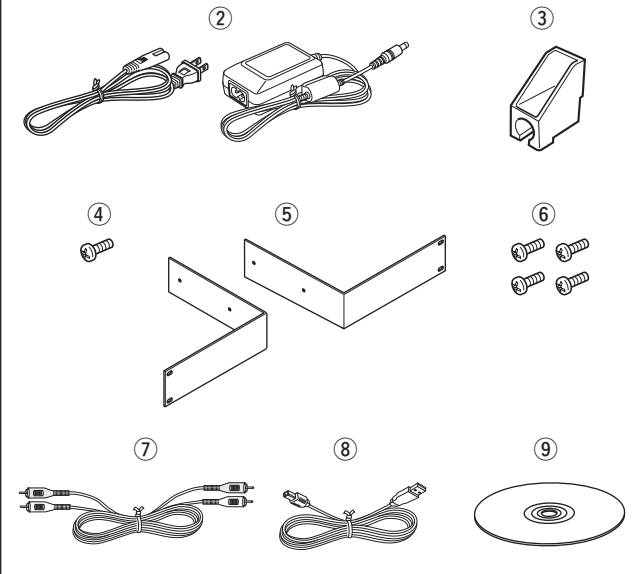

NOTE

Conduction noise or interference noise may cause the DN-F450R to malfunction. Therefore, when connecting this device to a computer, connect using the USB cable included.

Cautions on handling

• Before turning the power switch on

Check once again that all connections are correct and that there are no problems with the connection cables.

- Power is supplied to some of the circuitry even when the unit is set to the standby mode. When leaving home for long periods of time, be sure to unplug the power cord from the power outlet.

• About condensation

If there is a major difference in temperature between the inside of the unit and the surroundings, condensation may form on parts inside the unit, causing the unit to fail to operate properly.

If this happens, let the unit sit for an hour or two with the power off and wait until there is little difference in temperature before using the unit.

• Cautions on using mobile phones

Using a mobile phone near this unit may result in noise. If that occurs, move the mobile phone away from the unit when it is in use.

• Moving the unit

Turn off the power and unplug the power cord from the power outlet.

Next, disconnect the cables connected to other system units before moving the unit.

Attaching the mounting brackets for a 19-inch 1U half-sized rack

- The DN-F450R is half the size of 1U. Attach the included rack mounting brackets to the DN-F450R. Then it can be mounted in an EIA 19-inch rack.
- Remove two screws on the side panel of the DN-F450R.
- Attach the rack mounting bracket to the DN-F450R with the included two screws.
- Attach the bracket on the opposite side.

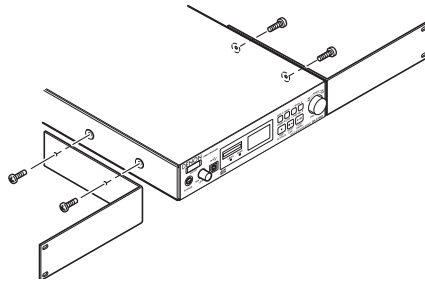

Mounting in a rack

- Do not cover the top of the unit. Remember, heat is dispersed from the DN-F450R's upper surface.
- Set up the installation environment carefully. For example, take care to protect the DN-F450R from heat from other devices. If necessary, use forced ventilation. The surrounding conditions must meet the specifications described in "Specifications" on page 42.
- If the DN-F450R is placed near an amplifier, tuner or other components, noise (induced hum) or beat interference may result (especially during AM or FM reception). If interference occurs, disconnect the DN-F450R or change the installation place.
- If the unit is not to be mounted in a rack, remove the rack mount brackets and attach the included feet.
- If there is electronic interference, install DN-F450R separately from other devices.

Part names and functions

Front panel

For buttons not explained here, see the page indicated in parentheses ().

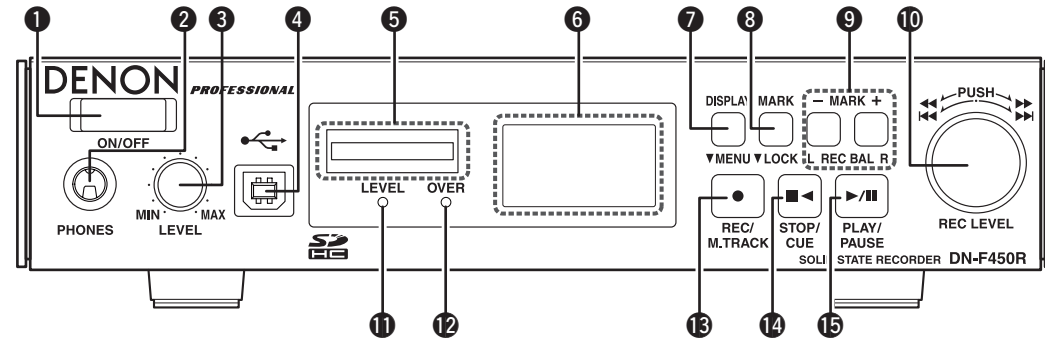

- | | | | |
|---|----------|---|----------|
| 1 Power switch (ON/OFF) | (11) | 11 Level indicator (LEVEL) | (12) |
| 2 Headphone jack (PHONES) | (8) | Lights green if the recording level or playback level exceeds the level set in "Level LED" in the setting menu. | |
| 3 Headphone volume adjustment switch (LEVEL) | (8) | 12 Level over indicator (OVER) | (16) |
| Press the switch to make it come out. After adjusting the volume, press the switch back in again. | | • Lights red if the recording level exceeds -1dB during recording or recording pause. | |
| NOTE | | 13 Recording and Manual track button (REC / M.TRACK) | (16, 17) |
| Do not turn the volume level too high when using headphones. | | • Lights red during recording. | |
| 4 USB port for PC | (8) | • Flashes red while recording is paused. | |
| 5 SD card slot | (9) | 14 Stop and Cue button (STOP / CUE) | (17) |
| 6 Display | (5) | 15 Play and Pause button (PLAY/PAUSE) | (19) |
| 7 Display and Menu button (DISPLAY, MENU/STORE) | (5, 11) | • Lights green during playback. | |
| 8 Mark and Lock button (MARK, LOCK) | (17, 25) | • Flashes green while playback is paused. | |
| 9 Mark search and Recording balance buttons (MARK -/+, REC BAL L/R) | (16, 20) | | |
| 10 Jog dial (I<<<, >>> / <<<, >>> PUSH) | (11, 20) | | |

Rear panel

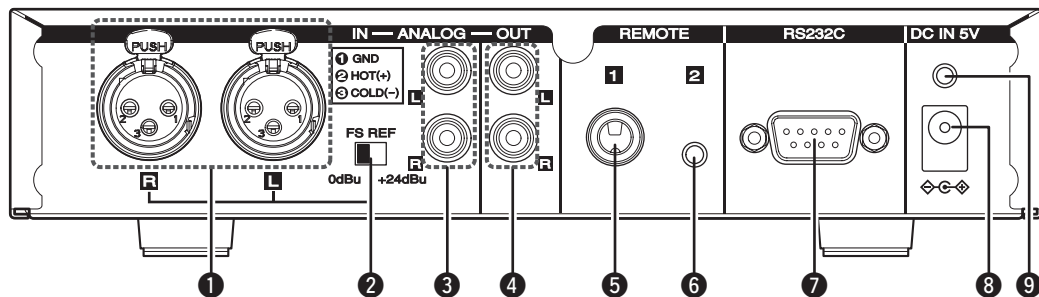

- | | |
|---|---|
| <p>1 Analog input (balanced) terminal (7)</p> <ul style="list-style-type: none"> • XLR type • Pin assignment: 1 GND, 2 Hot, 3 Cold • Applicable connector: XLR-3-12C or equivalent <p>2 FS switch (11)</p> <ul style="list-style-type: none"> • FS (full scale) indicates the maximum input level. <p>3 Analog input (unbalanced) terminal (7)</p> <ul style="list-style-type: none"> • RCA type <p>4 Analog output (unbalanced) terminal (7)</p> <ul style="list-style-type: none"> • RCA type <p>5 REMOTE terminal 1 (8)</p> <p>Connect a wired remote switch equipped with a monaural headphone jack.</p> | <p>6 REMOTE terminal 2 (8)</p> <p>Connect the microphone remote RC600PMD (sold separately) or external remote controller.</p> <p>7 RS-232C terminal (8)</p> <p>8 AC adaptor input terminal (8)</p> <p>Connect the supplied AC adaptor.</p> <p>9 Attachment hole for AC adaptor cord holder (8)</p> <p>This holder attachment hole is used to prevent the connected cord from detaching from the terminal.</p> |
|---|---|

Display

The display on the DN-F450R shows information about the DN-F450R and the various SD card attached. Details of the display differ depending on the operating status (stopped/recording/playing) of the DN-F450R.

Switching the display

Press DISPLAY.

- The display details change each time the button is pressed.
- For details on the display details shown during each operation, see “Display during stop status” (page 5), “Display during recording and recording pause” (page 6), “Display during playback and playback pause” (page 6)

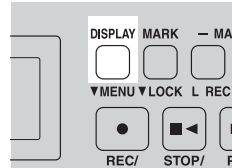

Common displays during each operation

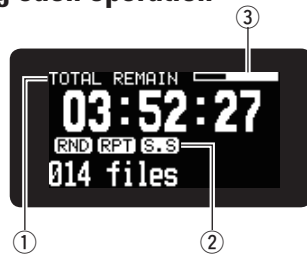

- ① Display Screen Title Display
- ② Mode Display during Settings

RND : Random playback mode (page 12)

RPT : Repeat playback mode (page 12)

S.S : Silent skip mode (page 12)

- ③ Recording time remaining on an SD card



Remaining capacity

Display during stop status

Total remaining capacity display

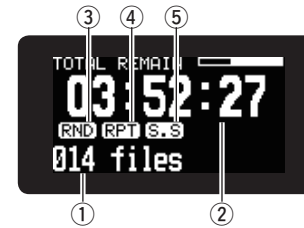

- ① Total number of files in the current folder
- ② Total remaining time display
- ③ Displayed when Random is set for the preset “Play Mode”
* Not displayed when Cont or Single is set.
- ④ ON/OFF indicator for the preset “Repeat”
* Not displayed when it is OFF.
- ⑤ ON/OFF indicator for the preset “Silent Skip”
* Not displayed when it is OFF.



If the remaining time exceeds 100 hours, “99: 59 : 59” is displayed.

Current time/Date display



- ⑥ Current date
- ⑦ Current time

Recording setting information display

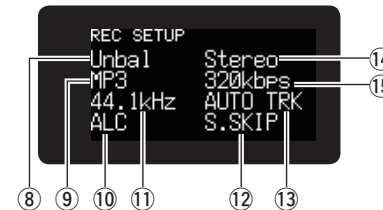

- ⑧ Recording input source
- ⑨ Recording file format
- ⑩ “ALC” indication of “Level Cont” preset menu
*This indication is not displayed when the recording level control is set to “Manual”.
- ⑪ Sampling frequency
- ⑫ ON/OFF indication of “Silent Skip” preset menu
*This indication is not displayed when the silent skip is set to OFF.
- ⑬ ON/OFF indication of “Auto Track” preset menu
*This indication is not displayed when auto track is set to OFF.
- ⑭ Recording channel
- ⑮ MP3 bitrate
*Not displayed when the recording file format is PCM.

Display during recording and recording pause

Recording elapsed time display



- ① File name during recording
- ② Recording elapsed time

Total remaining recording time display



- ③ Total remaining recording time
 - The remaining time changes depending on the recording format selected in the preset menu.



If the remaining time exceeds 100 hours, "99: 59 : 59" is displayed.

Recording input level display



- ④ Recording input level
- ⑤ Level meter peak hold value (largest of L/R is displayed)

Recording setting information display

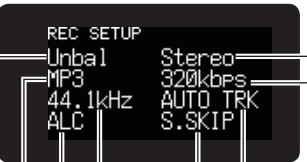

- ⑥ Recording input source
- ⑦ Recording file format
- ⑧ "ALC" indication of "Level Cont" preset menu
*This indication is not displayed when the recording level control is set to "Manual".
- ⑨ Sampling frequency
- ⑩ ON/OFF indication of "Silent Skip" preset menu
*This indication is not displayed when the auto track is set to OFF.
- ⑪ ON/OFF indication of "Auto Track" preset menu
*This indication is not displayed when the silent skip is set to OFF.
- ⑫ Recording channel
- ⑬ MP3 Bitrate
*Not displayed when the recording file format is PCM.

Display during playback and playback pause

Playback elapsed time display



- ① File name during playback
- ② Playback elapsed time
- ③ Playback position on a file
 - Position is not displayed for files recorded as VBR.

Playback remaining time display



- ④ Playback remaining time
 - "VBR" is displayed when the playback file is VBR.



If the remaining time exceeds 100 hours, "99: 59 : 59" is displayed.

Playback output level display



- ⑤ Playback output level
- ⑥ Level meter peak hold value (largest of L/R is displayed)

File information display



- ⑦ File created date
- ⑧ Playback channel
- ⑨ MP3 bitrate
 - This indication is not displayed when the file format is PCM.
- ⑩ Number of marks
- ⑪ Sampling frequency/Quantized bit number

Connections







NOTE

- Do not plug in the power cord until all connections have been completed.
- When making connections, also refer to the operating instructions of the other components.
- Insert the plugs securely. Loose connections will result in the generation of noise.
- Be sure to connect the left and right channels properly (left with left, right with right).
- Connect the cables to the correct input and output terminals.
- Do not bundle power cords together with connection cables. Doing so can result in humming or noise.
- DN-F450R is not equipped for connecting a microphone.

Preparations

Cables used for audio connection

Select the cables according to the equipment being connected.

Audio cables	
Analog Connection (RCA) White  Red   Stereo audio cable (Included)	
Analog Connection (XLR)   Balanced cable (Sold separately)	
Cable for connecting to the computer	
 USB cable (Included)	

Audio connections

Analog connection (Unbalanced connection)

Connect line-level analog inputs/outputs to the analog (unbalanced) input/output terminals.

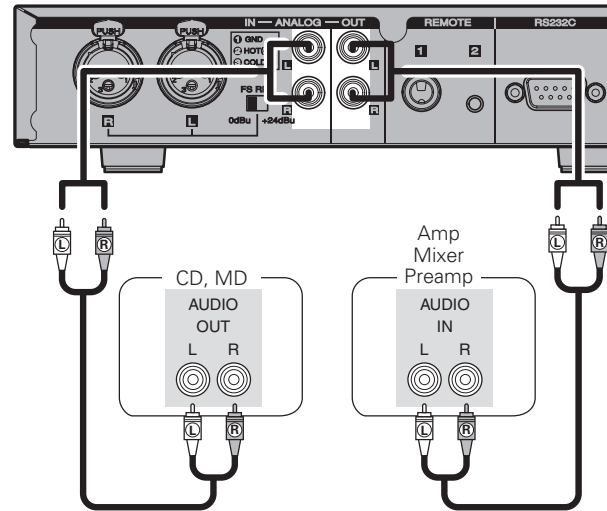

Analog connection (Balanced connection)

Connect line-level analog inputs/outputs to the analog (balanced) input terminals.

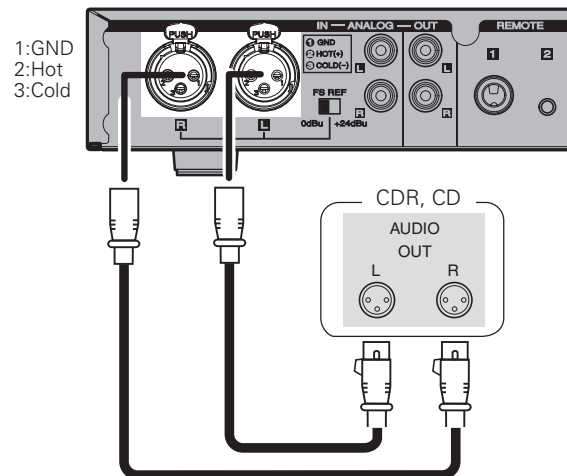

Connecting to a computer

Connect the computer USB cable to the USB port on the DN-F450R.

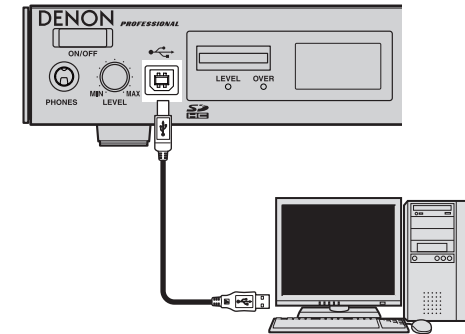

When you connect a computer using a USB cable to the USB port, you can easily copy audio files from an SD card on DN-F450R to the computer.

The USB connection is only enabled when the DN-F450R is stopped (recording/playback/menu display are disabled). For details on the USB mode, see "USB mode (Connection between DN-F450R) and the computer" (page 21).

Connecting the external control terminal

Remote terminal

REMOTE1

- Connect a wired remote switch equipped with a monaural headphone jack to the REMOTE terminal 1 on DN-F450R.
- When using two sets of this unit, connect them at each REMOTE terminal 1 using a cable with a monaural headphone jack.

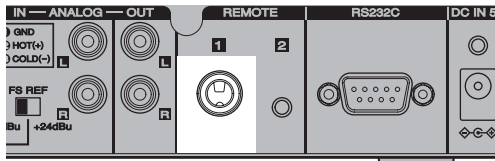

You can use five remote options using a wired remote switch ("REMOTE terminal 1" (page 26)).

You can also perform the Cascade recording function by connecting two DN-F450R recorders. For details on the Cascade recording function, see page 16.

REMOTE2

Connect the microphone remote RC600PMD (sold separately) or external remote controller to REMOTE terminal 2.

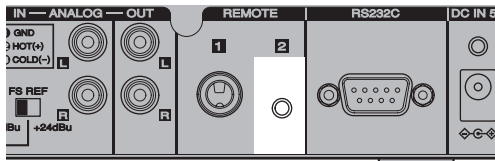

For the operation using REMOTE terminal 2, see page 27.

RS-232C terminal

Connect an RS-232C straight cable with a 9-pin D-sub connector to the RS-232C serial terminal.

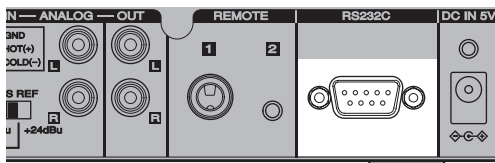

RS-232C control allows you to perform external control from the host. For details on RS232C control, see "RS232C control" (page 28).

Connecting headphone

Connect the headphones to the headphone jack (PHONES).

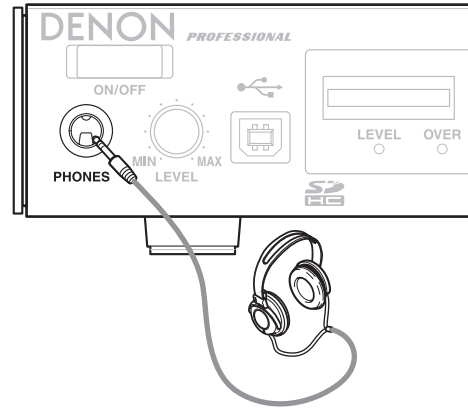

When you press the headphone volume adjustment switch (LEVEL), the switch will spring out. After adjusting the volume, press the switch back in again.

NOTE

To prevent hearing loss, do not raise the volume level excessively when using headphones.

Connecting the AC adaptor

Insert the AC adaptor when all other connections are completed.

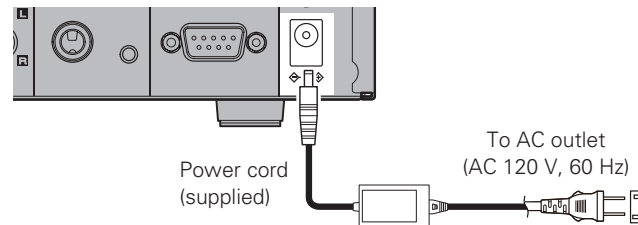

Attaching the power cord holder

- 1 Connect the plug of the AC adaptor to the DC power inlet.

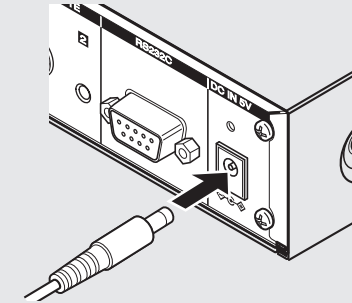

- 2 Pass the hole of the power cord holder to the cord of the AC adaptor. Then insert the holder to the mounting hole.

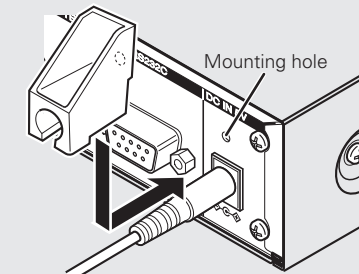

- 3 Fix the holder to the DN-F450R using the included screw.

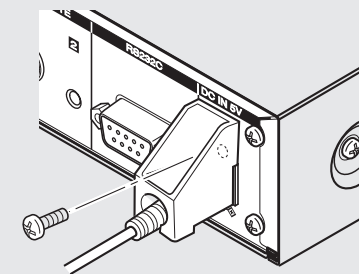

NOTE

- Be sure to insert the power plug firmly into the AC outlet. If the plug is not properly inserted, it could cause a malfunction or noise.
- Do not unplug the power cord while the unit is operating.
- Do not use a power cord other than the cord supplied with this unit.

Mounting SD card

Inserting an SD card

Insert an SD card all the way in to the SD card slot.

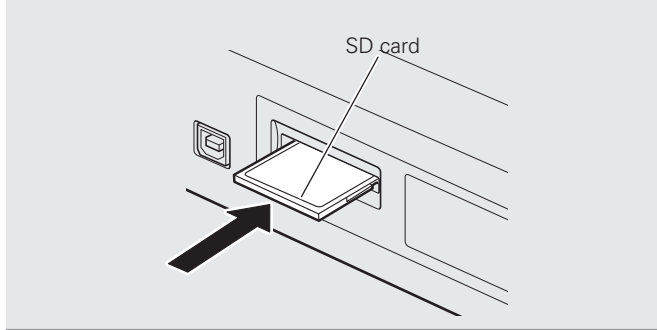

Insert an SD card all the way into the slot until it clicks.

Removing the SD Card

Check beforehand that playback from or recording to the SD card is stopped.

Press the SD card.

- The SD card springs out. Remove the card.

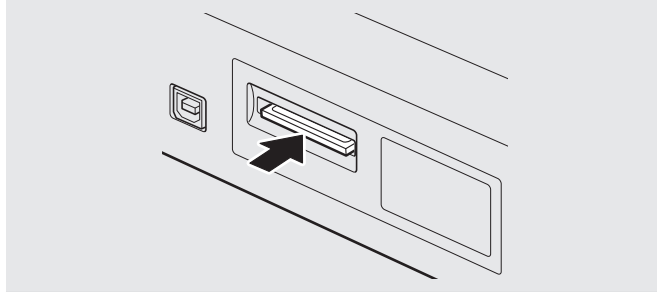

NOTE

Removing the SD card during recording may result in incorrect writing of the recorded file.
Do not remove the SD card during recording.

Cautions on SD card

- Do not use a cracked or warped SD card or one that has been repaired with adhesive.
- “Loading...” appears on the display when SD card is mounted or loaded. Do not remove the SD card while this message is displayed.

Setting defaults

Menu list

For details on the menu operations, see “Menu operations” (page 11). Furthermore, for detailed explanations of each item, see the table on the Reference Page.

Setting items	Detailed items		Contents	Reference page	Default values of each preset		
					Preset-1	Preset-2	Preset-3
01 File List			Manages and sets files and folders.	22	—	—	—
02 Presets	Presets-1	01 Select	Switches to the selected preset number.	11	—	—	—
	/Presets-2	02 Edit	Input Sets the audio input source for recording.	11	Bal	Bal	Bal
	/Presets-3		Rec Format Sets the audio format (MP3 or PCM) for recording.	11	MP3-128	MP3-320	PCM-16
			RecChan (Record Channel) Sets the number of recording channels.	11	Stereo	Stereo	Stereo
			Samp Freq (Sampling Frequency) Sets the sampling frequency for recording.	11	44.1k	44.1k	48k
			LevelCont Sets the adjustment method for the recording level.	12	ALC	Manual	Manual
			Level LED Sets the input/output level for the Level display lit on the main unit.	12	-6dB	-6dB	-6dB
			Auto Track Sets the recording time for one file.	12	Off	Off	Off
			Auto Mark Sets the writing of marks for silent detection.	12	Off	Off	Off
			SilentSkp (Silent Skip) Sets recording pause or recording restart by silent detection.	12	Off	Off	Off
			SilentLvl (Silent Level) Sets the silence level for Auto Mark and Silent Skip.	12	-38dB	-38dB	-38dB
			Skip Back Sets the amount of time used for skipping back a track during playback or pause.	12	2sec	2sec	2sec
			Play Mode Sets the playback mode.	12	Cont	Cont	Cont
			FinishMod (Finish Mode) Sets the stop status when playback is stopped.	12	Next	Next	Next
			Repeat Sets repeat playback.	12	Off	Off	Off
			PowOnPlay (Power On Play) Sets the operation when the power is switched ON.	12	Off	Off	Off
			Auto Cue Sets the settings for the auto cue function.	13	Off	Off	Off
			Remote1 Sets the operation to be performed when a control signal is received from the device connected to Remote Terminal 1.	13	StartPaus	StartPaus	StartPaus
			Machine ID Sets the machine ID information included in the file name.	13	1	1	1
			Default For each preset number, the preset setting contents are reset to their default value.	13	—	—	—
		03 Rename	Preset names can be changed to the desired name.	13	Preset-1	Preset-2	Preset-3
03 Display	Contrast		Sets the contrast of the display.	14	5		
	Time Form		Sets the type of the current time display.	14	12H		
	Date Form		Sets the display order of the date.	14	M/D/Y		
	File Sort		Sets the sorting method for the file listing order.	14	Date		
	Language		Selects the display language for the file names and folder names.	14	Eng		
	Default		Returns all settings details for “03 Display” to the default values.	14			
04 Time/Date			Sets the current date and time.	14			
05 Utility	01 Load Settings		Reads the preset menu and display menu setting data stored in the SD card, and replaces the DN-F450R settings with the setting data from the SD card.	15	 <p>The following uses are assumed for each of the preset default values.</p> <ul style="list-style-type: none"> • Preset-1: Recording at conferences etc • Preset-2: Compressed recording for music • Preset-3: Uncompressed recording 		
	02 Save Settings		Saves all of the preset menu and display menu setting data from the DN-F450R onto the SD card.	15			
	03 Media Format		Formats the SD card.	15			
06 F/W Version			Displays the DN-F450R’s current firmware version.	15			

NOTE

When you perform the Default operation on menus to initialize the settings for presets, the presets will be set back to the default values as shown on the right in the table.

Setting defaults

DN-F450R can record audio input on an SD card in the unit. DN-F450R is equipped with various recording and playback settings so that you can use wide-ranging applications to record and play back.

DN-F450R also allows you to program up to three preset settings. Use this feature to preset recording and playback setting patterns in advance, according to your purpose. You can switch the settings for a specific purpose by simply selecting the preset number.

Menu operations

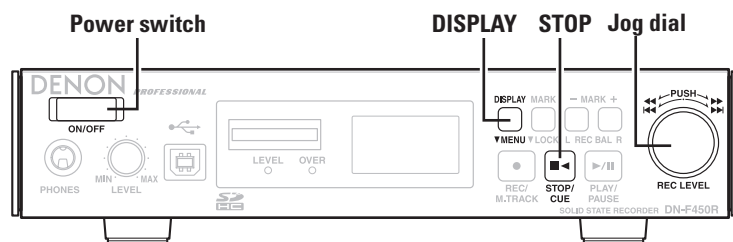

1 Press the power switch.

The power of DN-F450R is switched ON.

2 While DN-F450R is stopped, press **DISPLAY** for more than 1 second.

The menu list is displayed.

- For details on each of the setting items in the menu, see "Menu list" (page 10).

3 Rotate the jog dial to select the setting item that you want to change, and press the jog dial.

The following level menu list is displayed.

- When you select "File List", a file list appears. For file and folder management and setting methods, see "File/Folder settings" (page 22).

4 Select the setting item that you want to change, and press the jog dial.

The setting item is chosen.

- To continue to set other items, perform the operation in step 3.
- To return to the upper level menu from the menu item currently being set, press and hold the jog dial.

5 After you finish all settings, press **DISPLAY**.

The changed settings are saved, and the DN-F450R returns to the stopped status.



To cancel the settings, press the **STOP** button before saving the settings.

Manages and sets files and folders (File List) page 22

Settings for recording or playback (Presets) page 11

Display settings (Display) page 14

Time & date settings (Time/Date) page 14

Utility function (Utility) page 15



Checking the firmware Version (F.W Version) page 15



Settings for recording or playback (Presets)

These settings are performed independently for each of the 3 presets (Preset-1/Preset-2/ Preset-3). Firstly, select the preset number that you want to set from "02 Presets" in the menu. Next, select "02 Edit".

Setting Items	Setting details
Input Selects the audio input source for recording.	Bal: Records the XLR analog input terminal source. Unbal: Records the RCA analog input terminal source. When you perform recording by setting the audio input source to "Bal", be sure to set the FS switch on the rear panel to the maximum input level (+24dBu or 0dBu) before you start recording.
Rec Format Selects the audio format (MP3 or PCM) for recording.	MP3-320 / MP3-256 / MP3-192 / MP3-128 / MP3-64 / PCM-16 <ul style="list-style-type: none"> • Indicated bitrate values are those when you record as a stereo file. • Select the bitrate for the MP3 format. • Select the quantized bit number for the PCM format.
RecChan (Rec channel) Select whether to record as a stereo file or a monaural file.	Stereo: Records as a stereo (2-channel) file. Mono: Records as a monaural (1-channel) file.
Samp Freq (Sampling Frequency) Selects the sampling frequency for recording.	44.1k: Records at 44.1kHz. 48k: Records at 48kHz.

Setting Items	Setting details
LevelCont Select the adjustment method for the recording level.	Manual : The recording level can be adjusted to the desired value. ALC : DN-F450R automatically adjusts the recording level.  When the ALC setting is set to "ON", and when there is no input signal, the minimum value of the Recording input level meter may light up, which will not cause a problem to the recording.
Level LED Sets the input/output level for the Level display lit on the main unit.	-6dB / -12dB / -20dB / -38dB / -54dB  You can use this setting for various purposes besides the level meter on the display. For example, confirmation of the recording peak level and confirmation of the presence or absence of input signals.
Auto Track Creates a new file for each recording time set and continues recording.	Off : Record without creating a new file. 1 min/ 5 mins/ 10 mins/ 15 mins/ 30 mins/ 1 hour/ 2 hours/ 6 hours/ 8 hours/ 12 hours/ 24 hours <div style="border: 1px solid black; border-radius: 10px; padding: 2px; display: inline-block; background-color: #f0f0f0;">NOTE</div> <ul style="list-style-type: none"> • If the size of the recorded file exceeds 4GB, recording is continued on a new file irrespective of the set time. • There could be sound cutoffs for a short period of time between files depending on the capacity of a recorded file.
Auto Mark When input lower than the input level set in "10 Silent Level" continues for more than 3 seconds, marking information is written into the file. This mark is useful when searching for a specific point during playback.	Off : Turns the auto mark function off. On : Turns the auto mark function on.  <ul style="list-style-type: none"> • A maximum of 30 marks can be written to one file. • Marking numbers are attached in numerical order starting from 1. • Marks can also be added manually. For details, see "Adding marks (Marking)" (page 17). • Marks can be edited using the "DMP Mark Editor" software included. For details, see the instruction manual on the included CD-ROM.
SilentSkp (Silent skip) If input lower than the input level set in "10 Silent Level" continues for more than 3 seconds, recording is temporarily stopped. Recording is restarted when input above the set level is received again.	Off : Turns the silent skip function off. On : Turns the silent skip function on. The S.S icon is shown on the display.  If recording is paused by the silent skip function, the S.S indicator on the display flashes (page 5).

Setting Items	Setting details
SilentLvl (Silent Level) Sets the silent level when "08 Auto Mark" or "09 Silent Skip" is set to on.	-60dB / -54dB / -38dB / -20dB
Skip Back Sets the amount of time used for skipping back a track.	0.5 sec – 10 sec : Sets the time by increments of 0.5 seconds. 10 sec – 60 sec : Sets the time by increments of 5 seconds.  The skip back function rewinds a track for the set amount of time from the current playback position during playback or pause. This function is useful when you perform remote control functions using the Remote 2 expanded function switches. For details on the remote control, see "Enhancement for REMOTE terminal 2" (page 27).
Play Mode Selects the play mode.	Cont (Continuous) : Plays back files continuously in order. Playback stops when the final file has finished playing. Single : When the file has finished playing, it is stopped in the stop position set in "Finish Mode". Random : Plays files in random order. Playback stops when all files have finished playing. When "Random" is set, the RND icon is shown on the display.
FinishMod (Finish Mode) Sets the stop status when playback is stopped.	Next : When the STOP button is pressed during file playback, playback is stopped at the head of the next file. Recue : When the STOP button is pressed during file playback, playback is stopped at point where playback was previously started.
Repeat Sets the file to repeat playback.	Off : Repeat playback is not performed. On : Repeat playback is performed. The RPT icon is shown on the display.  The following operation is performed according to the play mode set in "Play Mode". <ul style="list-style-type: none"> • When "Cont" is set, all of the files are repeated. • When "Single" is set, the file that is currently being played back is repeatedly played back. • When "Random" is set, when all files have finished playing, random playback is started again in a different order. This operation is repeated.
PowOnPlay (Power On Play) Sets the operation performed when the power to the DN-F450R is switched on when SD card is mounted.	Off : Stops the operation when the power is switched ON. On : Files are automatically played back when the power is switched ON.

Setting Items	Setting details
<p>Auto Cue Sets the auto cue function. This item also sets the silent level of the silent portion at the beginning of a file.</p>	<p>Off: Turns the auto cue function off. -48dB / -42dB / -36dB</p> <p> The auto cue function temporarily stops playback at the point where playback restarts after skipping the silent portion at the beginning of a file.</p> <p>NOTE If the silent portion cannot be detected at the beginning of a file even after 20 seconds, the auto cue operation is automatically performed at the beginning of the file.</p>
<p>Remote1 Sets the DN-F450R operation to be performed when a switch control signal is received from an external device connected to Remote Terminal 1. For details on the REMOTE terminal 1, see "REMOTE terminal 1" (page 26).</p>	<p>StartPaus: During recording or playback, recording or playback starts when the switch of the external device is closed (short), and recording or playback is paused when the switch is opened (open).</p> <p>StrtPseTr: During recording, recording starts when the switch of the external device is closed (short), and paused when the switch is opened (open). Furthermore, if the switch is closed (short) again while recording is paused, the file is updated to a new file and recording restarts.</p> <p>Mark: During recording or playback, a mark is added when the switch of the external device is closed (short).</p> <p>ManualTrk: During recording, if the switch of the external device is closed (short), the file is updated to a new file and recording continues.</p> <p>Cascade: When you perform this function, connect another DN-F450R to this DN-F450R ("Cascade recording" (page 26)). If there is no recording space remaining on the SD card in the first DN-F450R while recording, this function automatically continues recording on the second DN-F450R.</p>
<p>Machine ID Sets the machine ID information included in the file name. A maximum of 8 characters can be input.</p>	<p>Preset-1/ Preset-2/ Preset-3</p> <p> • Since the default value of the machine ID is "1", the name of the first recorded file will be 1001.MP3 (when recorded in MP3 format). • If the machine ID is set as "aaaa", the name of the first recorded file will be "aaaa001.MP3". If the machine ID is 0 characters, the file name will be 001.MP3. (When recorded in MP3 format)</p> <p>NOTE The machine ID is common for the Preset-1 to Preset-3 settings. If it is changed, the new machine ID is applied to all Preset-1 to Preset-3 settings.</p>
<p>Default (Preset Default) Preset settings are returned to the default values for each preset.</p>	<p>Preset-1/ Preset-2/ Preset-3 Yes : Resets the selected preset name and its setting values to their default values. No: Values are not returned to the defaults.</p>

Renaming presets



Firstly, select the preset number that you want to rename from "02 Presets" in the menu. Next, select "03 Rename".

Setting Items	Setting details
<p>03 Rename Preset names can be renamed according to their use. A maximum of 8 characters can be input.</p>	<p><input type="checkbox"/> Entering Characters</p> <ol style="list-style-type: none"> Place the cursor in the position where you want to insert characters using the MARK+ and MARK- buttons. Rotate the jog dial to select the character to input. Press the jog dial to enter the character. Repeat steps ① to ③ until all characters are entered. Press the jog dial when the entry is completed. <ul style="list-style-type: none"> Saves the entered characters. <p><input type="checkbox"/> Deleting Characters</p> <ol style="list-style-type: none"> Place the cursor to the right of the character you want to delete the MARK+ and MARK- buttons. Press PLAY/PAUSE. <ul style="list-style-type: none"> Deletes a character on the left of the cursor. <p></p> <ul style="list-style-type: none"> By default, presets have a name that is eight characters long. To rename an existing name, delete the currently set characters first and then enter a new name. The following characters and symbols can be entered. A B C D E F G H I J K L M N O P Q R S T U V W X Y Z a b c d e f g h i j k l m n o p q r s t u v w x y z (space)! # \$ % & ' () + , - ; = @ [] ^ _ ' { } ~ 0 1 2 3 4 5 6 7 8 9 <u>j ç é ø ¥ ! \$ % " ' @ ° ± ² ³ ´ µ ¶ · ¸ ¹ º » ¼ ½ ¾ ¿ À Á Â Ã Ä Å Æ Ç È É</u> <u>Ê Ë Ì Í Î Ï Ñ Ò Ó Ô Õ Ö × Ø Ù Ú Û Ü Ý Þ ß à á â ã ä å ç è é ê ë ì í î ï ð ñ ò ó ô õ ü ý þ ÿ</u> The characters on the above underlined part, from j to ÿ, are Latin alphabets. Alphabets are available when the display language is set to "Eng", but not available when it is set to "Jpn". For information about the display language, refer to "Language" (page 14). To cancel without saving the entered characters, press the MARK button before saving.

Display settings (Display)

Settings can be performed for the display.

Rotate the jog dial to select "03 Display".

Setting Items	Setting details
Contrast Sets the contrast of the display.	1 / 2 / 3 / 4 / 5 / 6 / 7 / 8 / 9 / 10 The higher the setting value, the brighter the display becomes.
Time Form Sets the type of the current time display.	12H: Switches to the 12-hour display (AM/PM). 24H: Switches to the 24-hour display.
Date Form Sets the display order of the date.	M/D/Y: Displays the date in Month/Date/Year order. D/M/Y: Displays the date in Date/Month/Year order.  The factory setting is "D/M/Y" for Europe.
File Sort Selects the sorting method for the file listing order.	Alpha (Alphabet) :Files are arranged in the order of symbols, numbers, and alphabets. Date: Files are arranged in date order.
Language Selects the display language for the file names and folder names.	Eng : Displays the file names and folder names in English. Jpn : Displays the file names and folder names in Japanese.  <ul style="list-style-type: none"> • When "Eng" is set, Japanese file names and folder names are not displayed correctly. • When this setting is changed, the unit is restarted in order for the setting change to be read.
Default Resets the Display Menu settings to the default values.	Yes: Values are returned to the defaults. No: Values are not returned to the defaults.

Time & date settings (Time/Date)

Sets the clock on the DN-F450R.



Rotate the jog dial to select "04 Time/Date".

Setting Items	Setting details
04 Time/Date Sets the built-in clock time. Records the time of this built-in clock as time data (recording start time) in a file.	01:00 AM: Enter the time. Jan 01/2010: Enter the year, month and date. <input type="checkbox"/> Entering Numbers <ol style="list-style-type: none"> ① Place the cursor in the position where you want to insert numbers using the MARK+ and MARK- buttons. ② Rotate the jog dial to select the number to input. ③ Repeat steps ① and ② to enter all of the numbers. ④ Press the jog dial when the entry is completed. <ul style="list-style-type: none"> • Save the settings, and the screen returns to the menu screen.  To cancel without saving the entered characters, press the MARK before saving.

Utility function (Utility)

Utilities perform such operations as saving and reading the various setting data for the DN-F450R and formatting the SD card.

Rotate the jog dial to select "05 Utility".

Setting Items	Setting details
01 Load Settings After reading the preset setting data stored on a SD card, changes the settings of DN-F450R to the setting data on the SD card. This function is used when more than one DN-F450R unit are used together to set all units with the same presets.	<p>❑ Operation</p> <ol style="list-style-type: none"> ① Rotate the jog dial to select "Load Settings", and press the jog dial. <ul style="list-style-type: none"> • "Load?" is displayed. ② Rotate the jog dial to select "Yes", and press the jog dial. <ul style="list-style-type: none"> • The preset setting data starts reading. • "Executing..." is displayed during the read process. • When the read process is complete, "Completed" is displayed, and the DN-F450R returns to the stopped state. <p> "DN-F450Rpreset.txt", which is located in the root directory in the media, is loaded.</p>
02 Save Settings Stores all of the current preset setting data on the SD card. To read the saved data onto a different DN-F450R, use the operation in "01 Load Settings".	<p>❑ Operation</p> <ol style="list-style-type: none"> ① Rotate the jog dial to select "Save Settings", and press the jog dial. <ul style="list-style-type: none"> • "Save?" is displayed. ② Rotate the jog dial to select "Yes", and press the jog dial. <ul style="list-style-type: none"> • The preset setting data starts being saved. • When the save process is complete, "Completed" is displayed, and the DN-F450R returns to the stopped state. <p> The file is saved as "DN-F450Rpreset.txt" in the root directory in the media. When this operation is performed, the existing "DN-F450Rpreset.txt" data is overwritten.</p>
03 Media Format Formats the SD card.	<p>❑ Operation</p> <ol style="list-style-type: none"> ① Rotate the jog dial to select "Media Format", and press the jog dial. <ul style="list-style-type: none"> • "Format SD" is displayed. ② Rotate the jog dial to select "Yes", and press the jog dial. <ul style="list-style-type: none"> • Formatting of the SD card starts. • "Executing..." is displayed during the formatting. • When the format process is complete, "Completed" is displayed, and the DN-F450R returns to the stopped state. <p>NOTE</p> <p>Before using an SD card, be sure to format it on DN-F450R. If the SD card is formatted on a computer, this could cause sound cutoffs during recording.</p>

Checking the firmware version (F.W Version)

Rotate the jog dial to select "06 F/W Version".

- Displays the DN-F450R's current firmware version.



Getting started
Part names and functions
Connections
Setting defaults
Recording
Play
USB mode and the computer
File/Folder settings
Control function
Information
Specifications
Index

Recording

This section explains how to specify a SD card folder for a recording file and to record into that folder.

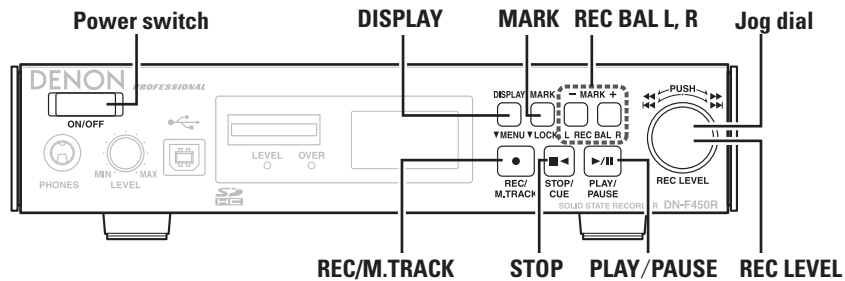

Selecting a folder to store recorded files

- 1** Press the power switch.
The power of DN-F450R is switched ON.
- 2** Press and hold **DISPLAY** for more than 1 second while stopped.
- 3** Select “File List” in the menu list and press the jog dial.
- 4** The folder list is displayed.



• For details on how to display the folder list, see “Displaying the File Menu (Preparation)” (page 22).

- 5** Rotate the jog dial to select the folder in which you want to save the recording file, and press the jog dial.
• To save a recorded file in a newly created folder, see “Creating folders (2 Make Folder)” (page 24).

- 6** Select “01 Select” in the folder list menu, and rotate the jog dial.

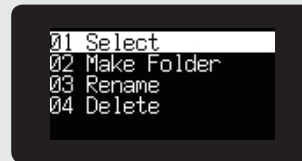

• Choose the folder in which to store the recorded file, and display the file list of that folder.

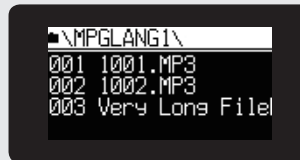

- 7** Press **STOP**, and the screen returns to the previous screen.

NOTE

To record on an SD card, be sure to format it on DN-F450R before recording. If the SD card is formatted on a computer or is used for recording without formatting it, this could result in sound cutoffs during recording. For details on the formatting procedure, see “03 Media Format” (page 15).

Recording

- 1** Press **REC/M.TRACK** to pause recording.
 - **REC/M.TRACK** flashes red.
 - Monitors the input source set for “Input” in the preset menu.
- 2** Adjust the recording level using **REC LEVEL**.



- To adjust the recording level, change “LevelCont” in the preset menu to “Manual”.
- When you adjust the recording level, make sure that the peak level is not 0dB by monitoring the level meter and level over display (LEVEL).
- When the “Level Cont” preset menu is set to “ALC”, you cannot adjust the recording level using **REC LEVEL**.

- 3** Use **RECBAL L, R** to adjust the recording balance.



- To adjust the recording balance, set “LevelCont” in the preset menu to “Manual”.
- When **RECBAL L** is pressed, the R (right) volume decreases by 1dB. When **R** is pressed, the L (left) volume decreases.
- This setting is maintained after the power is switched off.
- When the pre-recording adjustments are completed, stop the source playback, and playback the recording source again from the start.
- When the “Level Cont” preset menu is set to “ALC”, you cannot adjust the recording level using **RECBAL L, R**.

4 Press **REC/M.TRACK** to start recording. **REC/M.TRACK** changes to being lit red.

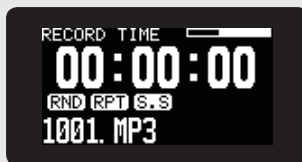

- You can adjust the recording level and balance even during recording.

If there are no folders in the SD card, a folder “MPGLANG” is automatically created, and recorded files are stored in that folder. For details on transferring that file into a different folder, see “Moving files (06 Move)” (📖 page 23).

❑ To stop recording

Press **STOP**.

- Recording stops, and **REC/M.TRACK** goes out.
- The recorded file information is displayed. At this time, you can playback the recorded file by pressing **PLAY/PAUSE**.
- When the **STOP** button is pressed again, the total file number or overall remaining time is displayed.

❑ To pause recording

Press **PLAY/PAUSE** during recording.

- Recording is paused, and **REC/M.TRACK** flashes red.
- Press **REC/M.TRACK** again to resume recording on the same file.



When “Auto Mark” in the preset menu is set to “On”, a mark is added at the point where the recording is resumed from the paused status.

❑ Cautions on recording capacity

The amount of recording capacity required differs depending on the set recording format, number of recording channels, and sampling frequency.

To ensure that you do not run out of recording capacity during recording, check the recordable time in the “Recording time chart” (📖 page 18) before starting recording. For details on checking various setting details, see “Display” (📖 page 5).

Operations during recording

Add a file during recording (Manual track)

The manual track function divides tracks at the desired place during recording. Recording continues as a new file.

Press **REC/M.TRACK** during recording.

- The file is cut at the point where the button is pressed, and recording continues in a new file.



Files can also be divided at a specified amount of time. For details, see “Auto Track” (📖 page 12) in the preset menu.

NOTE

- There could be sound cutoffs for a short period of time between files depending on the capacity of a recorded file.
- If the size of a file being recorded reaches 4GB, recording is continued by automatically switching to a new file.
- The manual track function is not available for two seconds after starting recording.

Adding marks (Marking)

By writing marking information to files, during playback you can search for marks and start playback from specific locations. By using this method, you can create specific search points within files without splitting files.

For details on how to search and playback from marks, see “Searching for Marks” (📖 page 20).

Press **MARK** during recording.

A mark is added at the point where the button was pressed.



- A maximum of 30 marks can be written to one file.
- Marks can also be added automatically. For details, see “Auto Mark” (📖 page 12) in the preset menu.
- Marks can be edited using the “DMP Mark Editor” software included.
For details, see the instruction manual on the included CD-ROM.

Recording time chart

All of the recording times are approximate times. Differences occur between SD card made by different manufacturers.

Recording time

Stereo file

Setting	Bitrate	Recordable time (Hours: Minutes)					
		1GB	2GB	4GB	8GB	16GB	32GB
PCM-16 (48kHz)	1536 kbps	1:29	2:58	5:56	11:51	23:42	47:24
PCM-16 (44.1kHz)	1411 kbps	1:37	3:13	6:27	12:54	25:48	51:36
MP3-320	320 kbps	7:07	14:13	28:27	56:56	113:47	227:33
MP3-256	256 kbps	8:53	17:47	35:33	71:07	142:13	284:27
MP3-192	192 kbps	11:51	23:42	47:24	94:49	189:38	379:16
MP3-128	128 kbps	17:47	35:33	71:07	142:13	284:27	568:53
MP3-64	64 kbps	35:33	71:07	142:13	284:27	568:53	1136:07

Monaural file

Setting	Bitrate	Recordable time (Hours: Minutes)					
		1GB	2GB	4GB	8GB	16GB	32GB
PCM-16 (48kHz)	768 kbps	2:58	5:56	11:51	23:42	47:24	94:49
PCM-16 (44.1kHz)	705 kbps	3:13	6:27	12:54	25:48	51:36	103:12
MP3-320	160 kbps	14:13	28:27	56:53	113:47	227:33	455:07
MP3-256	128 kbps	17:47	35:33	71:07	142:13	284:27	568:53
MP3-192	96 kbps	23:42	47:24	94:49	189:38	379:16	758:31
MP3-128	64 kbps	35:33	71:07	142:13	284:27	568:53	1137:47
MP3-64	32 kbps	71:07	142:13	284:27	568:53	1137:47	2275:33



If the recording conditions are the same, the recording time of a monaural file will be twice longer than the recording time of a stereo file.

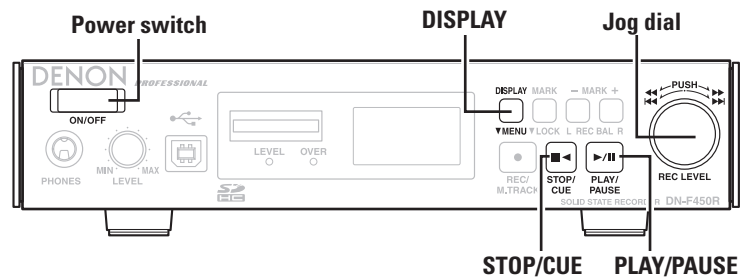

Selecting the folder to playback

- 1** Press the power switch.
The power of DN-F450R is switched ON.
- 2** Press and hold **DISPLAY** for more than 1 second while stopped.
- 3** Select “File List” in the menu list and press the jog dial.
- 4** The folder list is displayed.
- 5** Rotate the jog dial to select the folder that you want to play, and press the jog dial.
- 6** Select “01 Select” in the folder list menu, and rotate the jog dial.

• For details on how to display the folder list, see “Displaying the folder menu (Preparation)” (page 23).



- 7** Press **STOP**, and the screen returns to the previous screen.

Playback

Rotate the jog dial to select the file that you want to play, and press **PLAY/PAUSE** or the jog dial.

- Start playback.
- **PLAY/PAUSE** lights green.



DN-F450R can play back files in VBR (Variable Bit Rate) format.

To stop playback

Press **STOP/CUE**.

- Playback stops, and **PLAY/PAUSE** goes out.
- The playback position is moved to the playback start position set for “Finish Mode” in the preset menu and stops playback.
- When **STOP/CUE** is pressed again, DN-F450R is put in stop status and the total number of files or total remaining time is displayed.
- The playback stop position varies as follows depending on the setting for “Finish Mode” in the preset menu.

When Next is set : When **STOP/CUE** is pressed during file playback, playback is stopped at the head (point B) of the next file.

When Recue is set : When **STOP/CUE** is pressed during file playback, playback is stopped at point where playback was previously started (point A).

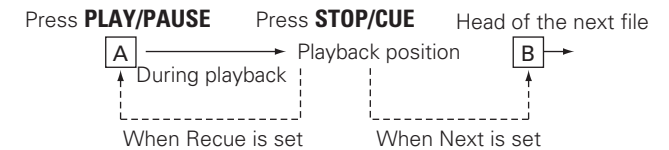

To pause playback

Press **PLAY/PAUSE** during playback.

- Playback is paused, and **PLAY/PAUSE** changes to flashing green.
- When **PLAY/PAUSE** is pressed again, playback is restarted.

Operations during playback

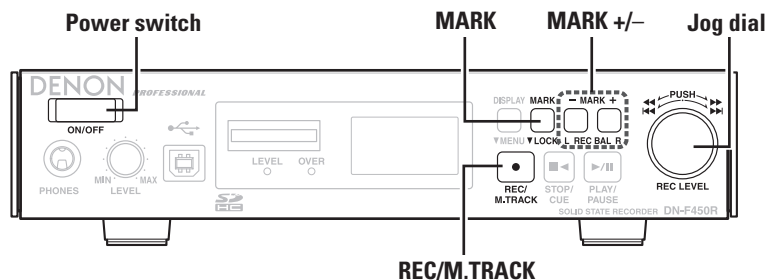

File switching (◀◀, ▶▶)

Rotate the jog dial during playback or while stopped.

- Rotating in a clockwise direction switches to the next file.
- Rotating in the anticlockwise direction switches to the start of the current file, and then to previous files.

Fast forward and fast rewind (Search ◀◀, ▶▶)

During playback, press and hold the jog dial and rotate it clockwise or counterclockwise.

- Rotate the jog dial counterclockwise for fast rewind playback.
- Rotate the jog dial clockwise for fast forward playback.
- The operation changes as indicated below depending on how many times you press the jog dial.
 - While holding in the jog dial, press it once Double speed
 - While holding in the jog dial, press it twice 10 x speed
 - While holding in the jog dial, press it 3 times 50 x speed
 - While holding in the jog dial, press it 4 times 100 x speed



- Sound is not output at 50 x and 100 x speeds.
- When fast forward search is used to the end of the last file, or when fast rewind search is used to the start of the first file, the file pauses.

NOTE

- Search cannot be performed on files that are recorded using VBR.
- If a VBR file is found during the search process, the search ends at the VBR file.

Add marks (marking)

By writing marking information in files, you can search for marks and play back from a certain point.

Press **MARK** during playback and pause.

A mark is added at the point when you press it.



- You can write up to 30 marks in a file.
- You can edit marks with the supplied software "DMP Mark Editor". For more information, see the instruction manual for "DMP Mark Editor" on the supplied CD-ROM.

NOTE

- You cannot add marks to MP3 files that are not recorded by DN-F450R.
- You cannot add marks when files are recorded in VBR.

Searching for Marks

During playback or pause, press **MARK+** or **MARK-**.

- When **MARK+** is pressed, the tracks are forwarded to the next marked point and paused.
- When **MARK-** is pressed, the system returns to the previous marked point and is paused.

Dividing a file

You can divide a recorded file at the specified position.

1 Perform a file search, pause playback at the position where you want to divide a file, and then press **REC/M.TRACK**.

"Divide?" is shown in the display.

- If you do not wish to divide the file, rotate the jog dial to "No", and push the jog dial.

2 Rotate the jog dial to select "Yes", and press the jog dial.

"Executing..." is displayed, and the file is divided.

- When the division process has finished, "Completed" is displayed, and playback is stopped at the start of the second of the divided files.



- "_A" is appended to the name of the first division file and "_B" is appended to the name of the second division file. e.g.) When a file named 1001.MP3 is divided

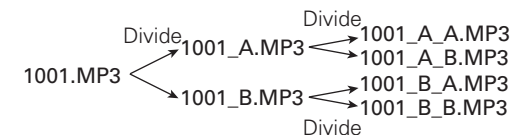

The original file is not deleted even if it is divided. In the above case, there are total of seven files after the division.

- You can also divide a file by pressing **REC/M.TRACK** during playback.

NOTE

- Files with file names that contain more than 253 characters cannot be divided. In this case, "Long Title" appears in the display. Rename the file, and try dividing again.
- VBR files cannot be divided.

USB mode (Connection between DN-F450R) and the computer

When a computer is connected using the provided USB cable to the USB port on the DN-F450R, the following operations can be performed.

- Transfers data stored on an SD card of DN-F450R to a computer and plays back and copies data on the computer.
- Transfers MP3 or WAV files stored in a computer to an SD card of DN-F450R.

Connecting to a computer

- The computer connected to the DN-F450R must be running one of the following operating systems.
WindowsXP, Windows Vista, Windows7, MacOS X
- When DN-F450R is connected to a computer, an SD card mounted on DN-F450R is recognized as a removable disc by the computer.

1 Switch on the computer.

- For details on how to operate the computer, see the computer's operating manual.

2 Press the power switch on the DN-F450R.

The DN-F450R power switches ON.

3 Mount the SD card into the DN-F450R.

- For details on the mounting the SD card, see "Mounting SD card" (page 9).

4 While the DN-F450R is stopped, connect the computer to the DN-F450R PC USB port using the USB cable provided.

- When the connection is complete, the DN-F450R display looks as follows.



- The computer will recognize the SD card mounted on DN-F450R as a removable disc.

5 Remove the USB cable.

- After the required tasks for USB mode are completed, remove the USB cable from DN-F450R. The USB mode is canceled and DN-F450R returns to the stopped state.

NOTE

Do not remove mounted SD card from the DN-F450R while it is connected to the computer. Doing so may cause the data on the SD card to become corrupt, and may damage the SD card.

□ About DMP Mark Editor

You can use a computer to edit the files and marks recorded on a SD card of DN-F450R with the supplied Windows application program "DMP Mark Editor".

【Main functions】

- Playback, copy, divide, combine, and delete files
- Move, add, and delete marks



- For details on the installation and operation procedures of the DMP Mark Editor, see the DMP Mark Editor Instruction Manual stored in the supplied CD-ROM.

File/Folder settings

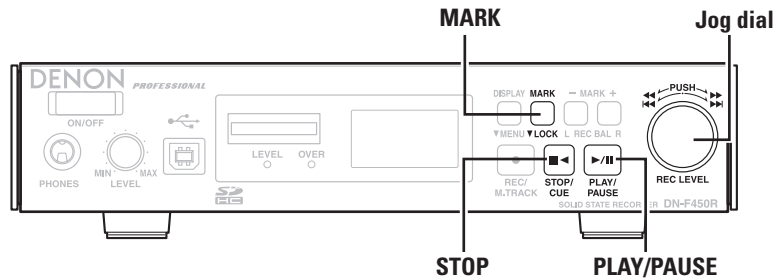

File menu

Perform file management operations. You can check file information, change file names, and delete, copy and move files.

□ Displaying the File Menu (Preparation)

1 Press and hold **DISPLAY** for more than 1 second while stopped.

2 Select “File List” in the menu list and press the jog dial.

The file list is displayed.



- Press **PLAY/PAUSE** while the file list is displayed to playback the selected file.
- To display the folder list, select the folder name displayed at the top, and press the jog dial.

3 Rotate the jog dial to select the file to operate, and press the jog dial.

The file menu is displayed.

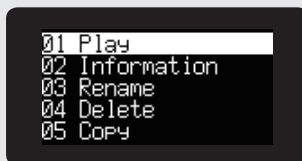

- Press **STOP** when the file menu is displayed to return to the stopped state.

□ File menu list

Display	Explanation
01 Play	Plays back a file.
02 Information	File information is displayed.
03 Rename	Changes the file name
04 Delete	Deletes a file.
05 Copy	Copies the file to a different folder.
06 Move	Moves a file from a the current folder into a different folder.
07 Delete Mark	Deletes all marks from the selected file.

Playing back files (01 Play)

Plays back the selected file.

Rotate the jog dial to select “01 Play”, and press the jog dial.

- Press **STOP** to return to the file list.

File information (02 Information)

The selected file information is displayed.

Rotate the jog dial to select “02 Information”, and press the jog dial.

File information is displayed.

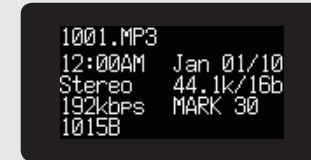

- Press the jog dial to return to the file menu.
- Press **STOP** to return to the stopped state.

Renaming files (03 Rename)

Renames the selected file name.

1 Select “03 Rename” in the folder list menu, and rotate the jog dial.

The rename menu is displayed.

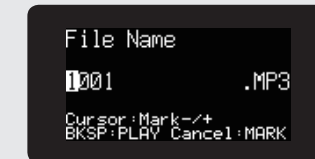

2 Change the file name.

- The method for renaming the file is the same as “Renaming presets” (page 13).

3 Press the jog dial to save the changes.

- To return to the previous screen without saving the changes, press **MARK**.



- If a space is entered as the first or last character in the file name, the space is deleted when the file name is saved.
- No more than 255 characters can be added for the file name.

Deleting files (04 Delete)

Deletes the selected file.

1 Select “04 Delete” in the folder list menu, and rotate the jog dial.

“Delete?” is displayed.

- Select “Yes” with the jog dial to delete the file.
- Select “No” with the jog dial to return to the file menu.
- Press **STOP** to return to the stopped state.

Copying files (05 Copy)

Copies the selected file to a different folder.

1 Select “05 Copy” in the folder list menu, and rotate the jog dial.

The folder list is displayed.

2 Rotate the jog dial to select the copy destination folder, and press the jog dial.

The copy process starts. “Executing...” is displayed during the copy process.

- Press **STOP** to return to the stopped state.

Moving files (06 Move)

Moves the selected file to a different folder.

1 Select “06 Move” in the folder list menu, and rotate the jog dial.

The folder list is displayed.

2 Rotate the jog dial to select the folder that you want to move, and press the jog dial.

The move process starts. “Executing...” is displayed during the move process.

- Press **STOP** to return to the stopped state.

Deleting marks (07 Delete Mark)

Deletes all of the marks written into the selected file.

Select “07 Delete Mark” in the folder list menu, and rotate the jog dial.

“Delete Mark?” is displayed.

- Select “Yes” with the jog dial to delete the marks.
- Select “No” with the jog dial to return to the file menu.
- Press **STOP** to return to the stopped state.

Folder menu

Perform folder management operations. You can move the selected folder to the current directory, rename folders, delete folders, and create new folders.

□ Displaying the folder menu (Preparation)

1 Select “File List” in the menu list.

The file list is displayed.

2 Select the folder name at the top of the list and press the jog dial.

The folder list is displayed.

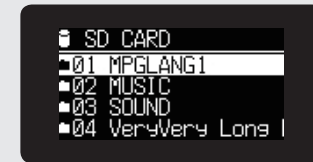

3 Rotate the jog dial to select the folder to operate, and press the jog dial.

The folder menu is displayed.



- Press **STOP** when the folder list is displayed to return to the stopped state.

NOTE

- Only folders right under the root directory in the media are recognized. Files right under the root directory are not recognized.
- A maximum of 32 folders can be recognized. Other folders are not recognized.

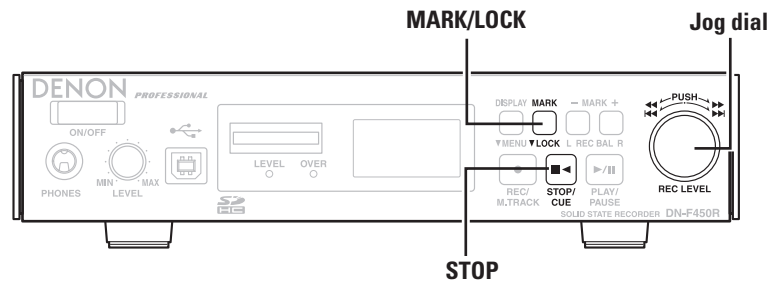

Folder menu list

Display	Explanation
1 Select	Selects the folder to be recorded to or played.
2 Make Folder	Creates a new folder.
3 Rename	Changes the folder name
4 Delete	Deletes the folder.

Selecting folders (1 Select)

Select to create a recording file in this folder, or to playback the files in this folder.

Rotate the jog dial to select “1 Select”, and press the jog dial.

Displays the list of files in this folder.

Creating folders (2 Make Folder)

Creates a new folder.

Rotate the jog dial to select “2 Make Folder”, and press the jog dial.

A folder named “NewFolder” is added to the folder list.



- When a folder “NewFolder” already exists in the folder list, “Already Exists” appears. Change the name of the folder “NewFolder” in the folder list and create a new folder.
- A maximum of 32 folders can be created. If 32 folders already exist, “Full Folder” is displayed for 1 second. Delete unnecessary folders and then create a new folder.

Renaming folders (3 Rename)

1 Rotate the jog dial to select “3 Rename”, and press the jog dial.

The rename menu is displayed.

2 Change the file name.

- The method for renaming the file is the same as “Renaming presets” (page 13).

3 Press the jog dial to save the changes.

The display returns to the folder list.

- To return to the previous screen without saving the changes, press **MARK**.



- If a space is used as the last character of the folder name, the renamed folder will not contain the space.
- No more than 255 characters can be added for the file name.

Deleting folders (4 Delete)

Deletes the folder.

Rotate the jog dial to select “4 Delete”, and press the jog dial.

“Delete?” is displayed.

- Select “Yes” with the jog dial to delete the file.
- Select “No” with the jog dial to return to the folder menu.
- Press **STOP** to return to the stopped state.



When there is only one folder in a SD card, this folder cannot be deleted. If you try to delete this folder, “Can not...” appears.

Other functions

Locking operation buttons (Key lock)

When **MARK/LOCK** is pressed for more than 1 second, the key lock is set and you will not be able to operate any button.

- If buttons are operated while the key lock is enabled, “Key Locked” is displayed.



When **MARK/LOCK** is pressed again for more than 1 second, the key lock mode is canceled.

Control function

REMOTE terminal 1

When an open/close type wired remote switch or another DN-F450R is connected to the REMOTE (input) terminal 1 on DN-F450R, you can perform the following operations.

Wired remote switch operations

When an open/close type wired remote switch such as a foot pedal is connected to the REMOTE (input) terminal 1 on DN-F450R, the following operation is performed according to the setting for "Remote1" in the preset menu.

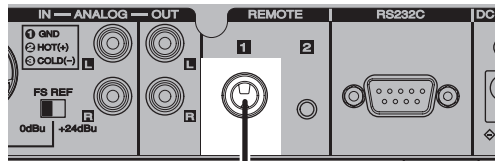

Wired Remote Control:

- Size : $\phi 6$
- Pin : 2 pin (Tip - Sleeve)

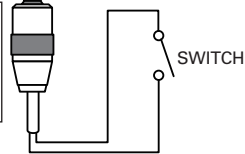

Start pause (StartPaus)

During recording/playback or recording/playback pause, starts the operation when the wired remote switch is short circuited (closed) and pauses the operation when it is open.

Start pause track (StrtPseTr)

During recording or recording pause, operation starts when the wired remote switch is closed (short) whereas the operation is paused when the switch is opened (open).

If the switch is closed (short) again after recording is paused, recording will restart in a new file.

Mark

During recording/playback or recording/playback pause, adds a mark when the wired remote switch becomes short circuited (closed).

Manual track (ManualTrk)

During recording or recording pause, a new file is created when the wired remote switch is closed (short).

Cascade

During recording or pause, recording starts when the wired remote switch is closed (short).

	Start pause (Recording, playback)	Start pause track (Only when recording)	Mark (Recording, playback)	Manual track (Only when recording)	Cascade (Only when recording)
Open→Closed	Start	Start	Add mark	Create new file	Start
Closed→Open	Pause	Pause at the next file	---	---	---

Example: Start pause

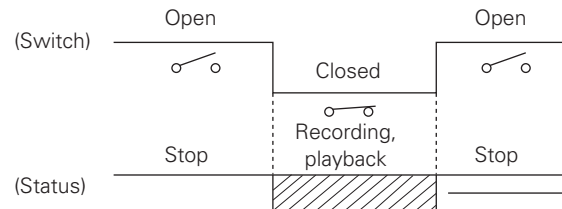

Cascade recording

The cascade recording function automatically continues recording on the second DN-F450R if the SD card set in the first DN-F450R runs out of recording space during recording.

You can perform the cascade recording function by connecting another DN-F450R to this DN-F450R via REMOTE (input) terminal 1.

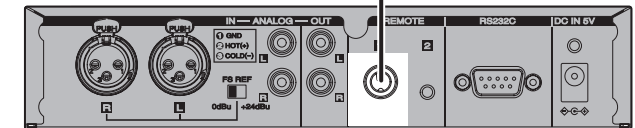
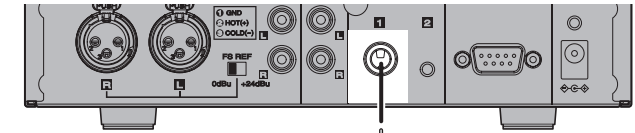

- 1 Use a monaural audio cable to connect REMOTE terminal 1 of both DN-F450R recorders to each other.
- 2 Set "Remote1" preset menu to "Cascade" on both DN-F450R recorders.
 - For the setting method, see "Remote1" (page 13).
- 3 Press REC/M.TRACK to put both DN-F450R recorders in pause state.
- 4 Press REC/M.TRACK on the recorder with which you want to record.
 - Recording starts.
 - When the SD card set in the first DN-F450R runs out of recording space during recording, recording is continued automatically on the second DN-F450R.

NOTE

- Unless you put the DN-F450R that is not recording in the recording pause state, the cascade recording function will not be performed.
- If the SD card set in the second DN-F450R (that takes over recording) is running low of recording space, the cascade recording function will not be performed.

REMOTE terminal 2

You can use the optional microphone remote RC600PMD with DN-F450R. RC600PMD (sold separately) is a remote used by attaching it to the microphone for interviewing purposes. RC600PMD is equipped with a 1.5m cord and 4 terminal mini plugs. Menu settings are not required to use the RC600PMD.

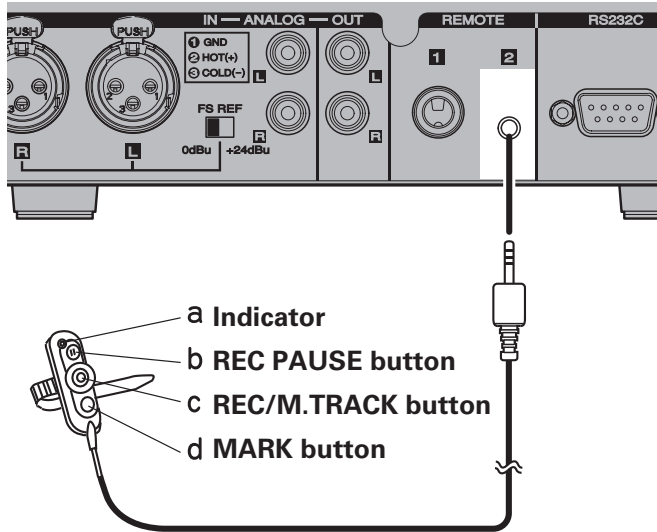

RC600PMD

- a** Indicator
- Lights green when in standby mode or when stopped
 - Lights red during recording
 - Flashes red during recording pause
 - If a signal that exceeds the peak signal is input during recording or recording pause, it returns from flashing orange to being lit red.
- b** Recording is paused when this button is pressed.
- c** Recording is started/restarted when this button is pressed. Files can also be added manually. (Manual track)
- d** When this button is pressed, a mark is added during recording or playback.

Enhancement for REMOTE terminal 2

If a remote device is incorporated into the circuit shown in the diagram below, PLAY, FF (fast forward) and REW (rewind) switches can be operated as remote control functions. Therefore, you can use this feature to smoothly perform tasks for transcribing audio to letters and text for dictations and tape transcriptions.

Circuit Diagram

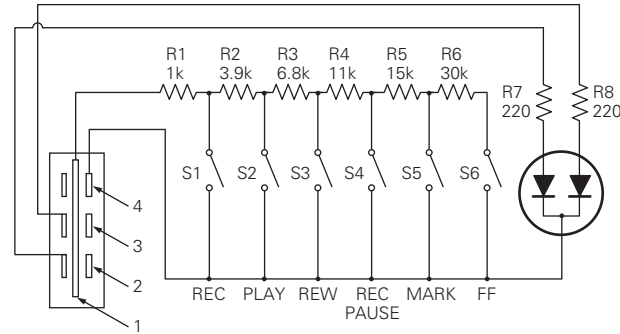

- As long as the PLAY switch is closed, DN-F450R performs playback. When the PLAY switch is opened, the track is skipped back and DN-F450R is put in pause state. The amount of time used for skipping back a track can be set using "Skip Back" preset menu (page 12). While the FF switch or REW switch is closed, DN-F450R performs the fast-forward or rewind operation accordingly and stops the operation when the switch is opened.
- Electrical Resistance Measurement Error: Within 5%
- Do not add external voltage. Doing so may cause malfunctions.
- Insulate the circuit so that the circuit cannot be touched directly. Static electricity causes malfunctions. Construct the circuit so that it is protected from static.
- Do not operate the DN-F450R and circuit switch at the same time.
- DENON cannot accept any liability for damages or infringement of patents or any other rights that occur from the use of this circuit.
- These contents do not constitute an approval of the use of DENON or third party patents or other rights.
- The copying or reproduction of this circuit diagram in whole or in part is strictly forbidden.

Plug type (1/8" T-R-R-S Mini plug)

ø3.5/4P (TMP-B66)

- 1: Tip
- 2: Ring
- 3: Ring
- 4: Sleeve

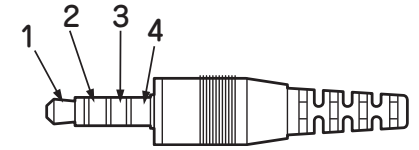

RS232C control

RS232C control

You will be able to perform the three control functions from the host by connecting an RS-232C straight cable to the RS-232C serial terminal (9-pin D-sub) connector.

[Three control functions]

- ① **Controlling and operating DN-F450R from the host** (☞ page 28)
- ② **Sending the status information to the host when DN-F450R receives a status request command from the host** (☞ page 29)
- ③ **Automatically sending the status information to the host when there is a change to the DN-F450R status** (☞ page 29)

☐ Connections

- Compatible Connector: 9-pin D-sub (male)
- Communication speed: 38,400 Bps
- Data Bit: 8 Bit
- Parity: None
- Stop Bit: 1 Bit
- Flow Control: None

Pin Arrangement

Pin Number	Signal Name
1	Ground
6	NC
2	TxD
7	NC
3	RxD
8	NC
4	NC
9	NC
5	S. Ground

☐ Structure of Control Commands

Each packet of a control command begins with the Start Character '@' and ends with the End Character "0x0D" as shown below.



☐ Structure of Command Codes

Item	Value (the hex value is indicated in parentheses)
Start character	'@' (0 x 40)
ID	'0' (0 x 30)
Command	Indicate a description of the command.
End character	'CR' (0 x 0D)

The response timeout is 100msec.

☐ Command Codes for ACK (Acknowledgement) and NACK (No acknowledgement)

Description	Hex value	Conditions for sending command codes
ACK	0 x 06	---
NACK	0 x 15	<ul style="list-style-type: none"> • When an End Character (0x0D) is received without a Start Character '@' • When an invalid command is received • When the signal transmission is stopped for 5msec or more between the characters of a command.



- When a command is received, DN-F450R responds either with an ACK or NACK command within 100 msec.
- If DN-F450R does not respond with either command even after 100 msec have elapsed, the next command is accepted.

① Controlling and operating DN-F450R from the host

When DN-F450R receives a control command from the host, the unit sends an ACK (acknowledgement) command and executes the command.

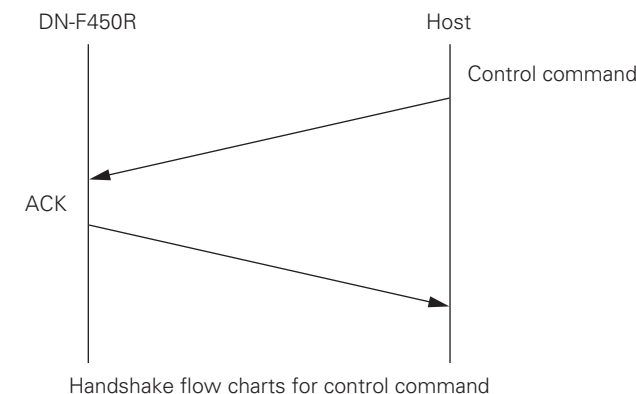

When DN-F450R receives data other than the specified commands or an End Character (0x0D) without a Start Character ('@'), a reception error occurs and the unit sends a NACK command. For "Control command code table" (☞ page 30).

② Sending the status information for a status request command from the host

When DN-F450R receives a status request command from the host, the unit responds with an ACK command and the status information.

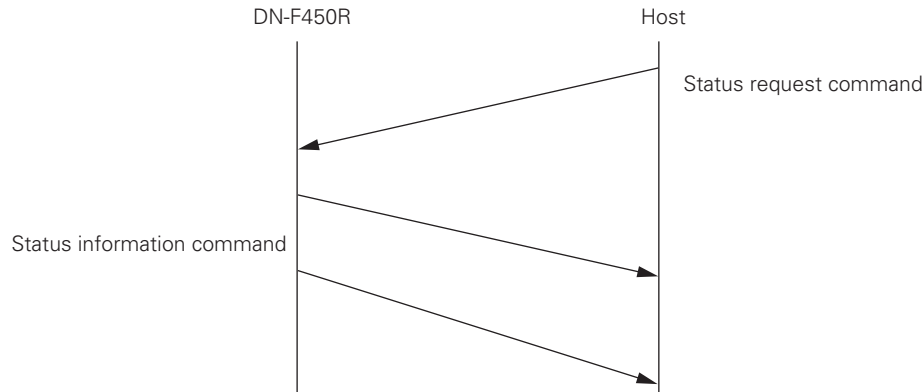

Handshake flow charts for status request command

When DN-F450R receives data other than the specified commands or an End Character (0x0D) without a Start Character ('@'), a reception error occurs and the unit ends a NACK command.

For "Status request and status information code table", see [page 35](#).

③ Automatically sending the status information when there is a change to the DN-F450R status

When there is a change to the DN-F450R status, the recording or playback file is switched, or there is a change to the SD card status or setting conditions, DN-F450R automatically sends the status information to the host.

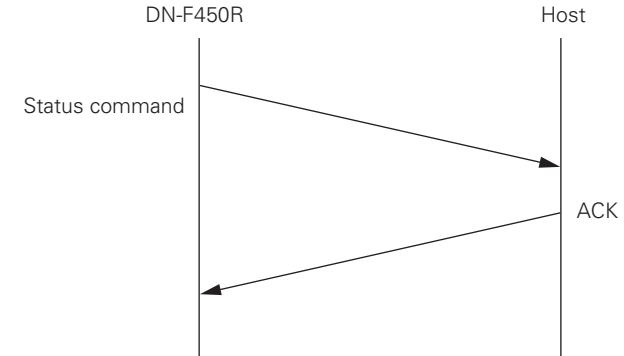

Handshake flow charts for status command

The commands used for sending status information are the same as the status information commands used for ②.

For "Status request and status information code table", see [page 35](#).

□ Control command code table

Command		Code	Comment	
Key operations	DISPLAY (Switch display)	@02311`r'	Switches the contents of the display	
	Rec Volume +	@023V+`r'		
	Rec Volume -	@023V-`r'		
	MARK (Add mark)	@023121`r'		
	Recording balance right	@023BR`r'		
	Recording balance left	@023BL`r'		
	File switching ►►	@02332`r'		
	File switching ◄◄	@02333`r'		
	Direct Jump	nnn	@0TRnnn`r'	nnn: File number (3 digits) E.g.) When transferring to File No. 002: @0TR002`r'
	PAUSE (Pause)		@02348`r'	Switches to recording pause when a command is received in the stopped state. Switches to playback pause during playback, and recording pause during recording
	Search (Fast forward)	ON	@02352`r'	
		OFF	@0235201`r'	
	Search (Fast rewind)	ON	@02350`r'	
		OFF	@0235001`r'	
	PLAY (Play)		@02353`r'	
	STOP (Stop)		@02354`r'	
	REC (Recording)		@02355`r'	Recording operation only (Manual track is a different command)
	M.Track (Manual track)		@023MT`r'	Divides the file at the position where the command is entered during recording, and increases the file number by 1
	MARK + (Search mark in the + direction)		@023M+`r'	Select the forward mark
	MARK - (Search mark in the - direction)		@023M-`r'	Select the rear mark
Divide file		@023Dd`r'		
SKIP BACK (Skip back)		@023SB`r'		
Lock panel's key		@023KL`r'		
Unlock panel's key		@023KU`r'		

Command		Code		Comment	
File List	File delete		xxx	@023TExxx\r'	xxx: Number of the file to be deleted. * Disabled if there is no file number to be deleted
	File mark erase		xxx	@023MExxx\r'	xxx: Number of the mark to be deleted. * Disabled if there is no mark number to be deleted
	Move file	nnn	XXXXXXXXXX	@0MVnnnXXXXXXXXXX\r'	nnn: Number of file to be moved. XXXX: Transfer destination folder name (max. 255 characters). * Disabled if the file number to be moved is not saved. Disabled if the transfer destination folder does not exist. Disabled if a file with the same name already exists in the transfer destination.
	Copy file	nnn	XXXXXXXXXX	@0CYnnnXXXXXXXXXX\r'	Number of file to be copied. XXXX: Copy destination folder name (max. 255 characters). * Disabled if the file number to be copied is not saved. Disabled if the copy destination folder does not exist. Disabled if a file with the same name already exists in the copy destination.
	Copy file fancel Move file cancel			@0CNAL\r'	Only enabled while a file is being copied or moved.
	Rename file	nnn	XXXXXXXXXX	@0RNnnnXXXXXXXXXX\r'	nnn: Number of the file to be renamed. XXXX: new file name (Do not enter a file extension. Max 255 characters) * File extensions cannot be changed. Disabled for file numbers that do not exist. Disabled if the Rename name already exists.
	Select folder	xxxxxxxx		@0SFxxxxxxxx\r'	xxxx: Selected folder name
	Make folder	xxxxxxxx		@0MFxxxxxxxx\r'	xxx:New folder name (Max 255 characters)
	Rename folder	xxxxxxxx	XXXXXXXXXX	@0RFxxxxxxxx:XXXXXXXXXX\r'	xxxx:Folder name to rename (Max 255 characters) '.':Separator XXXX.....:New folder name (Max 255 characters) * Disabled when the folder name to be renamed to does not exist.
	Delete folder	xxxxxxxx		@0DRxxxxxxxx\r'	xxxx:Name of the folder to be deleted (Max 255 characters) *Disabled when the folder name to be deleted does not exist.

Command			Code	Comment	
Preset menu	Preset-1		@OPS01\r'	Select Preset-1	
	Preset-2		@OPS02\r'	Select Preset-2	
	Preset-3		@OPS03\r'	Select Preset-3	
	Preset rename	n xxxxxxx	@OPNn:xxxxxxx\r'	n: Preset number xxxx: Set preset name	
	Input	UNBAL		@0INUB\r'	
		BAL		@0INBA\r'	
	Record format	PCM		@0AFPMXX\r'	XX: Bit length 16Bit =16
		MP3		@0AFM3XXX\r'	XXX: Bitrate 320kbps=320, 64kbps=064 etc Setting type is the same as the menu selection
	Rec channel	CH (Channel)	STEREO	@0CHST\r'	
			MONO	@0CHMO\r'	
	Sampling Frequency	Fs (Sampling frequency)	XX	@0FSXX\r'	XX: Sample rate 48kHz: xx=48, 44.1kHz: xx=44 Setting type is the same as the menu selection
	Rec level control	Manual		@0RLMA\r'	
		ALC		@0RLAL\r'	
Level LED	Level	XX	@0LEXX\r'	XX: Level (Indicate 2 digits without a minus sign) -6dB: XX=06, -12dB: XX=12, etc Setting type is the same as the menu selection	
Auto track	Time	HHMM	@0ATHHMM\r'	HH: Hours, MM: Mins Off=0000, 1min =0001, 5min =0005 30min =0030, 1hour =0100 Setting type is the same as the menu selection Values other than the selection are disabled	
Auto mark	ON		@0AM00\r'		
	OFF		@0AM01\r'		

- For details on the description of command functions such as the preset menu, see "Menu list" (📖 page 10).

Command		Code		Comment	
Preset menu	Silent skip	ON	@OSS00\r'		
		OFF	@OSS01\r'		
	Silent level	Level	XX	@0SLXX\r'	XX: Silent skip Level -20dB xx=20, -25dB xx=25 etc Setting type is the same as the menu selection
	Skip back (Time)	xxx		@0SBxxx\r'	xxx: Skip back setting time 0.5sec: xxx=005, 60sec: xxx=600 Setting type is the same as the menu selection
	Play mode	Cont		@0PMOF\r'	
		Single		@0PMSP\r'	
		Random		@0PMRD\r'	
	Finish mode	Next		@0FMNT\r'	
		Recue		@0FMRC\r'	
	Repeat	ON		@0RE00\r'	
		OFF		@0RE01\r'	
	Power on play	ON		@0POPL\r'	
		OFF		@0POST\r'	
	Auto cue	OFF		@0AC01\r'	
		xx (dB)		@0ACxx\r'	xx : Off=01, -48dB=48, -42dB=42, -36dB=36
	Remote1	StartPause		@0RCSP\r'	
		StartPauseTrack		@0RCST\r'	
		Mark		@0RCMA\r'	
		M.Track		@0RCMT\r'	
		Cascade		@0RCCS\r'	
Machine ID	xxxxxxxxxxx		@0MIxxxxxxxxxxx\r'	xxx: MachineID(0~8 characters)	
Preset default			@0DEFL\r'	All selected presets are returned to the default values	

Command			Code	Comment
Display settings	Contrast	XX	@0BNXX\r'	XX:01~10
	Time form	12H	@0TF12\r'	
		24H	@0TF24\r'	
	Date form	MDY	@0DFMD\r'	
		DMY	@0DFDM\r'	
	File sort	Alphabet	@0FRAL\r'	
		Date/Time	@0FRDA\r'	
	Language	English	@0LNUS\r'	
Japanese		@0LNJP\r'		
Display menu default		@0DEDI\r'		
Utility settings	Load settings		@0PVLD\r'	
	Save settings		@0PVSA\r'	
	Media format		@023FOMAT\r'	

□ Status request and status information code table

When the DN-F450R receives a status request command from the host, it sends the status information to the host.

When there is a change to the DN-F450R status, the DN-F450R automatically sends the status information to the host.

Status request command (DN-F450R → Host)		Status information command (DN-F450R → Host)			Comment	
Request.	Command	Answer	Command			
Status related	Media	@0?CD `r`	Media	No card	@0CDNC`r`	
				Card in	@0CDCI`r`	
				Unformat	@0CDUF`r`	
				Write protect	@0CDWP`r`	
	Status	@0?ST`r`	Stop	STOP (Stop)	@0STST`r`	
				PLAY STOP (Stops at the head of the current file)	@0STTS`r`	
			Play system	PLAY (During playback)	@0STPL`r`	
				PLAYPAUSE (Playback pause)	@0STPP`r`	
				Auto cue	@0STAC`r`	Searching auto cue
				Search (Fast forward)	@0STFF`r`	
				Search (Fast rewind)	@0STRW`r`	
			Recording system	REC (Recording)	@0STRE`r`	
				Rec pause (During recording pause)	@0STRP`r`	
			Others	Loading	@0STLD`r`	
				File List	@0STFL`r`	
				Busy	@0STBY`r`	During file copy etc.
				Menu (Preset, Display, Utility etc.)	@0STED`r`	
		Error	@0STER`r`			
Settings related	Rec volume setting	@0?RV`r`	Rec volume (Recording volume level)	LLRR	@0RVLLRR`r`	LL: Left Vol value 0dB: LL=00, Mute: LL=MU RR: Right Vol value -60dB: RR=60, Mute: RR=MU

Status request command (DN-F450R → Host)		Status information command (DN-F450R → Host)			Comment	
Request.	Command	Answer		Command		
File List related	Elapse time	@0?ET\r'	Elapse time	hh:mm:ss	@0ETHhmmss\r'	hh: Hours mm: Minutes ss: Seconds • The display is hh:mm:ss=000000 in the stopped state when no file is selected or there is no SD card mounted.
	Remain time	@0?RM\r'	Remain time	hh:mm:ss	@0RMhmmss\r'	hh: Hours mm: Minutes ss: Seconds • The display is hh:mm:ss=000000 in the stopped state when no file is selected or there is no SD card mounted.
	Rec remain time	@0?RT\r'	Rec remain time	hh:mm:ss	@0RThhmmss\r'	hh: Hours mm: Minutes ss: Seconds • The display is hh:mm:ss=000000 when SD card is mounted
	Total file number	@0?TT\r'	Total file number	XXX	@0TTXXX\r'	XXX: Total number of files (000~999)
	File number	@0?TR\r'	File number	XXX	@0TRXXX\r'	XXX: Current file number (000~999)
	File name (xxx: FileNo)	@0?Tnxxx\r'	File name	XXXXXX	@0TnXXXXXX\r'	XXXX.....: File Name (Max 255 characters, code is ISO/IEC 8859-1) * The display is @0Tn\r' when the file does not exist or there is no SD card mounted. File name is indicated as the full path E.g.) \Folder1\File1.mp3 → @0Tn\Folder1\File1.mp3\r'
	File size (xxx: FileNo)	@0?Tsxxx\r'	File size	XXXXXX	@0TsXXXXXX\r'	XXX.....: File size(kByte) 10KB → @0SZ10\r' (Decimal scale) * Display is XXXX=000 when there is no selected file or when there is no mounted SD card. 1KB=1024Byte

Status request command (DN-F450R → Host)		Status information command (DN-F450R → Host)			Comment	
Request.	Command	Answer	Command			
File List related	Recorded time (xxx: File No.)	@0?rtxxx\r'	Recorded time	YYYYMMDDhhmmss	@0rtYYYYMMDDhhmmss\r'	YYYY: Year (2010=10) MM: Month (January = 01) DD: Date (1st = 01) hh: Hour (24h display 0~23) mm: Minutes ss: Seconds *Display is YYMMDDhhmmss=000000000000 when there is no selected file or when there is no mounted SD card.
	Play track File Properties	@0?ch\r'	CH (Channel)	STEREO	@0chST\r'	
				MONO	@0chMO\r'	
		@0?af\r'	Algo (Recording format)	PCM	@0afPMXX\r'	XX: Bit length 16Bit = 16
				MP3	@0afM3XXX\r'	XXX: Bitrate 320kbps=320, 64kbps=064 etc Setting type is the same as the menu selection
	@0?fs\r'	Fs (Sampling frequency)	XX	@0fsXX\r'	XX: Sample Rate 48kHz=48, 44.1kHz=44 etc	
	Folder list	@0?FL\r'	Folder name	AAAAA BBBBB CCCCC	@0FLAAAAA:BBBBB:CCCCC\r'	AAA..., BBB..., CCC... are folder names. Each folder name has a maximum of 255 characters
Selected folder	@0?SF\r'	Folder name	0xxxxxxx	@0SF0xxxxxxx\r'	xxxxxxx: Selected folder name Up to 255 characters are supported for folder names.	
Preset menu	Preset	@0?PS\r'	Preset	Preset-1	@0PS01\r'	
				Preset-2	@0PS02\r'	
				Preset-3	@0PS03\r'	
	Preset name	@0?PNx\r'	Preset name	xxxxxxx	@0PNxxxxxxx\r'	n: Preset No. xxxx: Preset name to be set
	Input	@0?IN\r'	Input	UNBAL	@0INUB\r'	
				BAL	@0INBA\r'	
	Rec format	@0?AF\r'	Algo (Recording format)	PCM	@0AFPMXX\r'	XX: Bit length 16Bit=16
MP3				@0AFM3XXX\r'	XX is 320kbps=320, 64kbps=064 etc Setting type is the same as the menu selection	

- For details on the description of command functions such as the preset menu, see "Menu list" (page 10).

Status request command (DN-F450R → Host)		Status information command (DN-F450R → Host)			Comment	
Request.	Command	Answer	Command			
Preset menu	Rec channel	@0?CH\r'	CH (Channel)	STEREO	@0CHST\r'	
				MONO	@0CHMO\r'	
	Sample rate	@0?FS\r'	FS (Recording format)	XX	@0FSXX\r'	XX is 48kHz=48, 44.1kHz=44 etc Setting type is the same as the menu selection
	Rec level	@0?RL\r'	Rec level	Manual	@0RLMA\r'	
				ALC	@0RLAL\r'	
	Level LED	@0?LE\r'	Level	XX	@0LEXX\r'	
	Auto track	@0?AT\r'	A.Track time (Auto track setting time)	HHMM	@0ATHHMM\r'	HH: Hour MM: Minutes Off=0000, 1min =0001,5min =0005 30min =0030,1hour =0100 Setting type is the same as the menu selection
	Automark	@0?AM\r'	Automark	ON	@0AM00\r'	
				OFF	@0AM01\r'	
	Silent skip	@0?SS\r'	Silent skip	ON	@0SS00\r'	
				OFF	@0SS01\r'	
	Silent skip level	@0?SL\r'	Level	XX	@0SLXX\r'	XX: Silent level Off=01, -48dB=48, -42dB=42, -36dB=36
	Skip back	@0?SB\r'	Skip back	XXX(time)	@0SBXXX\r'	xxx: Skip Back setting time 0.5sec: xxx=005, 60sec: xxx=600 Setting type is the same as the preset menu
	Play mode	@0?PM\r'	Play mode	Cont	@0PMOF\r'	
				Single	@0PMSP\r'	
				RANDOM	@0PMRD\r'	
Finish mode	@0?FM\r'	Finish mode	Next	@0FMNT\r'		
			Recue	@0FMRC\r'		
Repeat mode	@0?RE\r'	Repeat mode	ON	@0RE00\r'		
			OFF	@0RE01\r'		
Power on play	@0?PO\r'	Power on Play	ON	@0POPL\r'		
			OFF	@0POST\r'		
Auto cue	@0?AC\r'	Auto cue	OFF	@0AC01\r'		
			XX(dB)	@0ACxx\r'	xx: Auto cue level E.g.) -48dB: xx=48	

Status request command (DN-F450R → Host)		Status information command (DN-F450R → Host)			Comment	
Request.	Command	Answer	Command			
Preset menu	Remote1	@0?RC\r'	Remote1	Mark	@0RCMA\r'	
				M.Track	@0RCMT\r'	
				StartPause	@0RCSP\r'	
				StartPauseTrack	@0RCST\r'	
				Cascade	@0RCCS\r'	
Machine ID	@0?MI\r'	Machine ID	xxxxxx	@0MIxxxxx\r'	xxx: MachineID (0~8 characters)	
Display menu	Contrast	@0?BN\r'	Contrast	XX	@0BNXX\r'	XX: 01~10 (Contrast) Values other than 01~10 are disabled
	Time form	@0?TF\r'	Time form	12H	@0TF12\r'	
				24H	@0TF24\r'	
	Dateform	@0?DF\r'	Dateform	MDY	@0DFMD\r'	
				DMY	@0DFDM\r'	
	File sort	@0?FR\r'	File older	Alphabet	@0FRAL\r'	
				Date/Time	@0FRDA\r'	
Language	@0?LN\r'	Language	English	@0LNUS\r'		
			Japanese	@0LNJP\r'		
Others	Version	@0?VN\r'	Version	xxxxxxxx	@0VNxxxxxxxxmmmmmmmm\r'	xxxxxxxx: Version No (8 digits) mmmmmm: Model Name (for DN-F450R: DNF450R)

Information

Error messages

Details on procedure for handling error messages

Error message	Cause/Solution	Page
No Media	• Cannot detect a SD card. Set the SD card again.	9
Unformat	• A file is recorded using an unsupported format. Format a media on DN-F450R or set the format to FAT16 or FAT32. For details, see the operation instructions of the SD card.	15
Full Media	• The remaining space on a SD card is running low. Replace the SD card with a new one or delete files that are no longer required.	5, 23
Full 999	• The maximum number of files (999 files) has been stored. Change a folder to store the recording files or delete files that are no longer required.	23, 24
Full MARK	• The maximum number of marks (30 marks) has been set, and a new mark cannot be added. To add a mark, delete marks.	23
Full Folder	• The maximum number of folders (32 folders) has been created, and a new folder cannot be created. To create a folder, delete other folders.	24
No Files	• A target file is not found. Confirm whether the file exists.	22
No MARK	• A target mark is not found. To search for a mark, add a mark.	17
ALC	• This error message appears when "ALC" is set for "07 LevelCont" in the preset menu. In that case, the recording level and recording balance cannot be adjusted. To adjust the recording level, change "07 LevelCont" to "Manual".	16
VBR	• This error message appears when a VBR file search is performed. Search cannot be performed on VBR files. The remaining time of a file is not displayed either.	20

Error message	Cause/Solution	Page
Already Exists	• A file with the same file name already exists. Change the file name and then press the jog dial to enter the data.	23
Long Title	• A file with a file name consisting of 253 characters cannot be divided. Rename the file and then divide the file.	20
Key Locked	• Key lock is activated. To operate DN-F450R, cancel the lock.	25
Card Locked	• The SD card protection switch has been set to lock. To perform a recording, cancel SD card protection.	9
Can not...	• This error message appears when an invalid operation is performed. The operation may become invalid because of other setting items such as the preset menu, so check the contents of the operation.	24
Err Format	• Format a media on DN-F450R or set the format to FAT16 or FAT32. For details, see the operation instructions of the SD card.	15
Err Media X	• This SD card is not compatible with DN-F450R. Replace it with a compatible SD card	–
Update File Error	• Error in upgrading a file or file system. Contact your local Denon repair service center listed on our website (URL: http://www.d-mpro.com).	–
Err FlashROM	• Error in flash ROM. Contact your local Denon repair service center listed on our website (URL: http://www.d-mpro.com).	–
Need Update	• Flash ROM download during the update was unsuccessful. Contact your local Denon repair service center listed on our website (URL: http://www.d-mpro.com).	–

Troubleshooting

If a problem should arise, first check the following:

1. Are the connections correct?

2. Is the set being operated as described in the owner's manual?

3. Are the external devices (mixer and player) operating properly?

If this unit does not operate properly, check the items listed in the table below.

If the symptom is not covered on the check list, contact your dealer or service centers.

Service centers are listed at <http://www.d-mpro.com>.

[General]

Symptom	Cause/Solution	Page
Does not turn on the power.	<ul style="list-style-type: none"> Check whether the power cord is firmly connected to the AC adaptor. 	8

[Recording]

Symptom	Cause/Solution	Page
Cannot perform recording.	<ul style="list-style-type: none"> The SD card could be the cause of this trouble. Replace the SD card with another one and retry. 	16
Although the music has been recorded properly, no sound is reproduced when it is played back.	<ul style="list-style-type: none"> Make sure that the recording level (REC LEVEL) is not set to MUTE. Make sure that the recording settings (such as input source) and all connections with external devices are correct. (For example, make sure to set the audio input source for recording to "Unbalance" and connect an external device to the analog input (RCA) terminal. Otherwise, the unit will record the music in silent mode.) 	16 7
There are sound cutoffs between files.	<ul style="list-style-type: none"> There may be minor sound cutoffs between files depending on the capacity of a recorded file. 	12, 17
There are sound cutoffs during recording to an SD card.	<ul style="list-style-type: none"> If an SD card is formatted on a computer, it may cause sound cutoffs during recording. When you use an SD card with this unit, make sure to format the card on this unit. 	15
There is a loud noise in the recorded file.	<ul style="list-style-type: none"> Check the level meter and Level Over Display (LEVEL) to make sure that the recording level does not exceed 0dB. Make sure that the electrical contacts of the cable connections are not poor. 	16 7

[Playback]

Symptom	Cause/Solution	Page
Cannot perform playback or does not recognize a file.	<ul style="list-style-type: none"> The SD card could be a cause of this trouble. Copy a file to another SD card and retry playback. Check whether this unit supports the format of the playback file. Check if the target folder is located right under the root directory in the SD card. Folders in other places are not recognized. Check whether the number of folders does not exceed 32. This unit recognizes up to 32 folders. 	- - 23 23
No sound is produced from the headphones.	<ul style="list-style-type: none"> Make sure that the headphone volume level adjustment switch (LEVEL) is not set to MIN. Check whether sound is reproduced from the headphones by using another audio file or SD card. 	8 -
Poor sound quality for playback on a computer.	<ul style="list-style-type: none"> Check the quality of the sound card and program of your computer. Check the frequency conversion program. <ul style="list-style-type: none"> This unit can record audio files using sampling frequencies of 48 kHz. Some of the computer programs convert the frequency to 44.1 kHz (a sample rate converter is used). Use a higher quality sample rate converter. 	- - -
Cannot read the files on a computer.	<ul style="list-style-type: none"> Check the functions of the computer program. Some playback and editing programs may not support the recording format of this unit. If the operation of this unit is unstable, turn off the power and disconnect the power cord. Then, restart the unit. 	-

[Operation]

Symptom	Cause/Solution	Page
Cannot add a character during renaming.	<ul style="list-style-type: none"> If the maximum number of characters has been already entered, you cannot add any more characters. To add a character, delete characters before adding. 	13
Cannot delete a folder.	<ul style="list-style-type: none"> When there is only one folder on a SD card, you cannot delete this folder. 	24

Specifications

□ Digital audio system

- **System** SOLID STATE
- **Compatible SD card** SD/SDHC card
- **Recording format**
 - MP3 MPEG1 Layer III audio compression
 - WAV 16-bit linear PCM
- **Recording MP3 bitrate (selectable)**
 - MONO 160, 128, 96, 64, 32 kbps
 - STEREO 320, 256, 192, 128, 64 kbps
- **Playable MP3 bitrate**
 - MONO 160, 128, 96, 64, 32 kbps
 - STEREO 320, 256, 192, 128, 64 kbps and VBR
- **Sampling frequency** 48, 44.1 kHz
- **Number of channels** 2 (STEREO)1 (MONO)
- **Audio frequency characteristics** 20 – 20,000 Hz ± 1.0 dB
- **S/N ratio, IEC-A filter** 96 dB(0dBFS During playback at 1 kHz)
- **Total harmonic distortion (at 0 VU (PCM))** 0.02 % (AES-17 20kHz filter)
- **Dynamic range** 96 dB

□ Input

- **Balanced input**
 - Type XLR (1:GND, 2:Hot, 3:Cold)
 - Input sensitivity +24 dBu, 0 dBu
 - (Recording level 0 dB (max)) (0 dBFS Reference)
 - Input impedance 20 kΩ
- **Unbalanced input**
 - Type RCA terminal
 - Input sensitivity 500 mVrms
 - Input impedance 22 kΩ

□ Output

- **Unbalanced output**
 - Type RCA terminal
 - Standard level 2 Vrms / Under 10 kΩ load
- **Headphone out** 20 mW/32 Ω

□ Others

- **Maximum capacity of SD card** 32GB
- **Maximum file size** 4GB
- **Maximum number of files** 999 files per folder
- **Maximum number of folders** 32 folders
- **Maximum number of layers (number of hierarchical levels)** 1 (Right under the root directory)
- **Maximum number of marks** 30 marks per file
- **Maximum number of characters for a file name** 255 characters
- **Maximum number of characters for a folder name** 255 characters
- **Maximum number of characters for preset names** 8 characters
- **Maximum number of characters for a machine ID** 8 characters

□ General

- **Power supply** DC 5 V
- **Power consumption** 5 W
- 0.3 W (Standby)
- **Environmental conditions**
 - Operating temperature 5 – 35 °C
 - Operating humidity 25 – 85 %, No condensation
 - Storage temperature –20 – 60 °C

□ Dimensions (including protruding parts)

- **Width** 217 mm / 8.5"
- **Height** 52 mm / 2.0"
- **Depth** 286 mm / 11.3"
- **Weight** 1.8 kg

□ Supplied accessories

- **Owner's manual** 1
- **AC adaptor** 1
- **AC adaptor cord holder** 1
- **Screw for fixing an AC adaptor cord holder** 1
- **19-inch rack mount brackets** 2
- **Screws for attaching a 19-inch rack mount brackets** 4
- **Audio cable** 1
- **USB cable** 1
- **CD-ROM** 1

[Dimensions (unit: mm)]

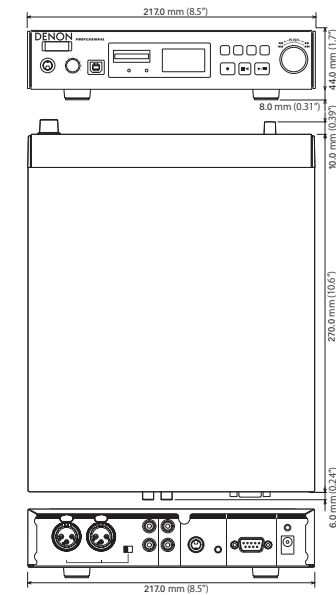

* For the purpose of improvement, the specifications and design are subject to change without notice.

Index

A

- Accessories 2
- Auto cue 13

B

- Bitrate 18

C

- Cables 7
 - Balanced cable 7
 - Stereo audio cable 7
 - USB cable 7
- Connections 7
 - AC adaptor 8
 - Analog 7
 - Computer 7
 - Remote terminal 8
 - RS-232C terminal 8

D

- Display 5

F

- File divide 20
- File list 22
- File menu 22
- Firmware version 15
- Folder list 23
- Folder menu 23
- Format 15
- Front panel 3

H

- Headphone 8

I

- Indicator 27
- Input source 11

J

- Jump to previous/next file 20

K

- Key lock 25

L

- Level meter 6

M

- Machine ID 13
- Manual track 17
- Marking 17
- Menu list 10

P

- Peak-Hold value 6
- Playback 19
- Power off 11
- Power on 11
- Preset menu 10

R

- Rack mount 3
- Random playback 12
- Rear panel 4
- Recording time chart 18
- Repeat playback 12
- RS232C control 28

S

- Sample rate 11
- SD card 9
- Search 20
- Search the marks 20
- Silent skip 12

U

- USB mode 21
- USB port 7



D&M Holdings Inc.