

# PSM®200

## Personal Monitor System User Guide

Guide de l'utilisation du système de retour personnel

Personal Monitor System Bedienungsanleitung

Guía del usuario del sistema de monitoreo personal

Guida all'uso del sistema di monitoraggio personale

Manual do Usuário do Sistema de Monitoração Pessoal

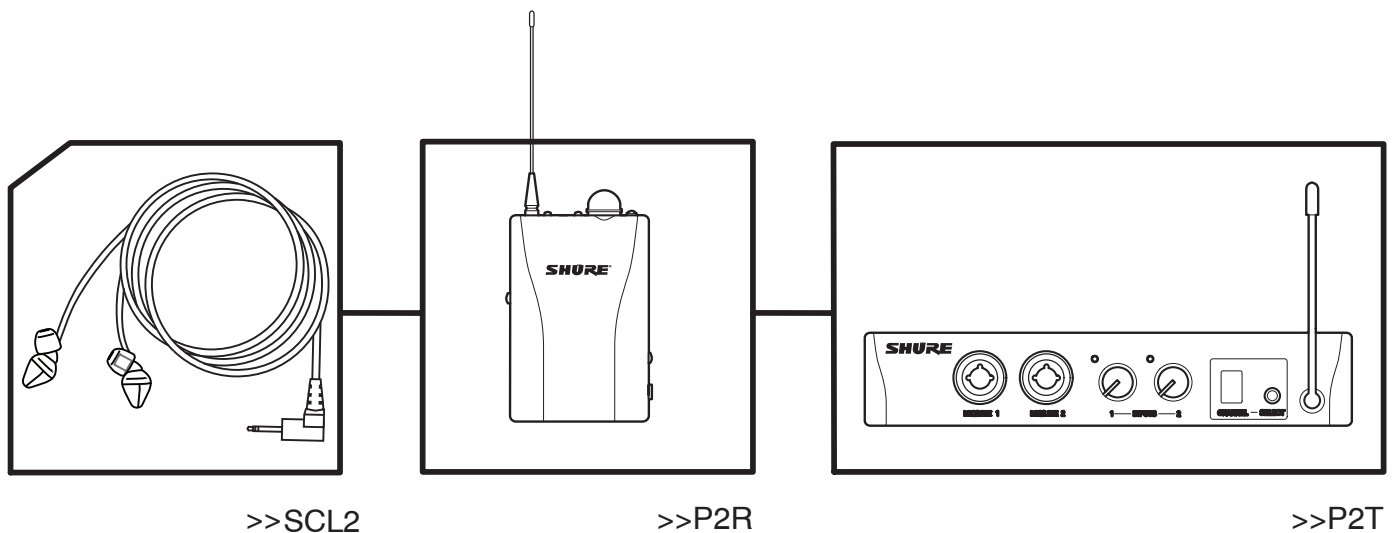

**WARNING!**

**USING THIS SYSTEM AT EXCESSIVE VOLUMES CAN CAUSE PERMANENT HEARING DAMAGE. USE AS LOW A VOLUME AS POSSIBLE.**

In order to use this system safely, avoid prolonged listening at excessive sound pressure levels. Please use the following guidelines established by the Occupational Safety Health Administration (OSHA) on maximum time exposure to sound pressure levels before hearing damage occurs.

90 dB SPL at 8 hours  
 95 dB SPL at 4 hours  
 100 dB SPL at 2 hours  
 105 dB SPL at 1 hour  
 110 dB SPL at 1/2 hour  
 115 dB SPL at 15 minutes

**120 dB SPL — avoid or hearing damage may occur**

It is difficult to measure the exact Sound Pressure Levels (SPL) present at the eardrum in live applications. In addition to the volume setting on the PSM, the SPL in the ear is affected by ambient sound from floor wedges or other devices. The isolation provided by the fit of quality earphones is also an important factor in determining the SPL in the ear.

Here are some general tips to follow in the use of this product to protect your ears from damage:

1. Turn up the volume control only far enough to hear properly.
2. Ringing in the ears may indicate that the gain levels are too high. Try lowering the gain levels.
3. Have your ears checked by an audiologist on a regular basis. If you experience wax buildup in your ears, stop using the system until an audiologist has examined your ears.
4. Wipe the earphones with an antiseptic before and after use to avoid infections. Stop using the earphones if they are causing great discomfort or infection.



**This symbol indicates important operating and maintenance instructions in the literature accompanying this unit.**

**LICENSING INFORMATION**

THIS RADIO EQUIPMENT IS INTENDED FOR USE IN PROFESSIONAL ENTERTAINMENT AND SIMILAR APPLICATIONS.

Changes or modifications not expressly approved by Shure Incorporated could void your authority to operate the equipment. Licensing of Shure wireless microphone equipment is the user's responsibility, and licensability depends on the user's classification and application, and on the selected frequency. Shure strongly urges the user to contact the appropriate telecommunications authority concerning proper licensing, and before choosing and ordering frequencies.

**NOTE: THIS EQUIPMENT MAY BE CAPABLE OF OPERATING ON SOME FREQUENCIES NOT AUTHORIZED IN YOUR REGION. PLEASE CONTACT YOUR NATIONAL AUTHORITY TO OBTAIN INFORMATION ON AUTHORIZED FREQUENCIES FOR WIRELESS MICROPHONE PRODUCTS IN YOUR REGION**

**Licensing:** Note that a ministerial license to operate this equipment may be required in certain areas. Consult your national authority for possible requirements.

**TABLE OF CONTENTS**

<b>QUICK SETUP GUIDES.....</b>	<b>3</b>
PSM®200 Wireless System.....	3
PR2 Receiver Quick Setup Guide .....	4
<b>INTRODUCTION .....</b>	<b>5</b>
The PSM200 Personal Monitor System .....	5
Features .....	5
<b>THE P2T TRANSMIXER .....</b>	<b>6</b>
Controls and Features .....	6
Audio Inputs and Outputs .....	6
Phantom Power .....	6
Selecting a Frequency Channel .....	6
<b>P2R RECEIVER.....</b>	<b>7</b>
Controls and Features .....	7
Battery Installation .....	7
Cable Management Groove .....	7
Wireless Mode .....	8
Wired Mode .....	8
Scanner Mode .....	8
MIX IN Jack .....	8
LIM LED.....	8
<b>SETUP .....</b>	<b>9</b>
Wireless System Setup .....	9
Hybrid Wired/Wireless System Setup.....	9
P2R Stand-Alone Wired Setup .....	9
<b>SYSTEM APPLICATIONS.....</b>	<b>10</b>
APPLICATION ONE: Wireless Setup for a Vocalist.....	10
APPLICATION TWO: Combination Wired and Wireless Setup for a Drummer.....	10
APPLICATION THREE: Two PSM200 Wireless Systems Used Simultaneously .....	11
<b>RACK MOUNTING THE P2T .....</b>	<b>11</b>
<b>TROUBLESHOOTING .....</b>	<b>12</b>
<b>ACCESSORIES.....</b>	<b>12</b>
<b>SPECIFICATIONS .....</b>	<b>12</b>
PSM200 System.....	12
P2T TransMixer .....	12
P2R Receiver .....	13
PSM200 Channel Frequencies.....	13
<b>CERTIFICATIONS .....</b>	<b>14</b>
<b>APPENDIX.....</b>	<b>14</b>
P2R Receiver MIX IN Jack Wiring Diagram .....	14

## QUICK SETUP GUIDES

### PSM®200 Wireless System

The following set-up illustration is for the complete PSM200 Wireless System, which includes the P2T TransMixer, the P2R Receiver, and the SCL2 Earphones. If you have purchased the P2R as a stand-alone wired personal monitor, see page 4.

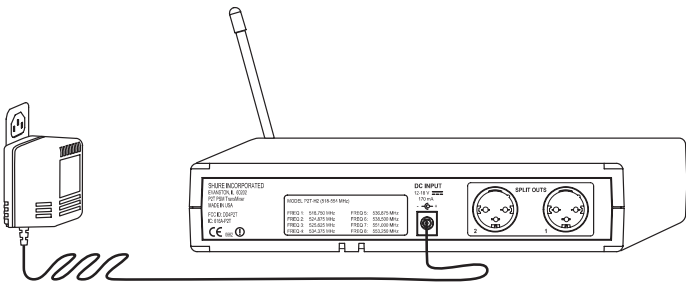

1. Plug in the power supply and connect it to the DC input on the rear panel of the P2T TransMixer.

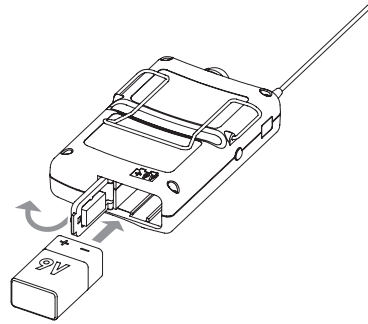

2. Insert a 9 Volt battery into the P2R Receiver, observing proper polarity.

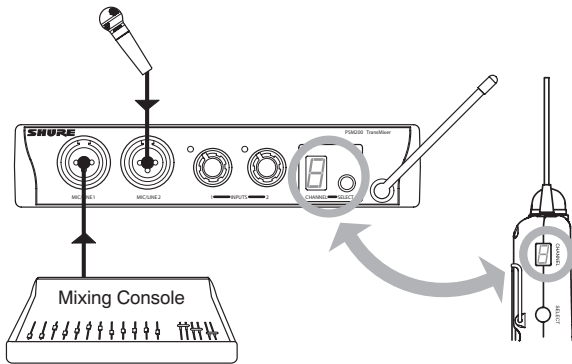

3. Connect audio sources to the MIC/LINE INPUTS on the front panel of the TransMixer.
4. Turn the Receiver volume knob clockwise past the click (ON). Keep the volume at a low setting.
5. Set the TransMixer and Receiver to the same frequency channel. See the *Selecting a Frequency Channel* section on page 6.

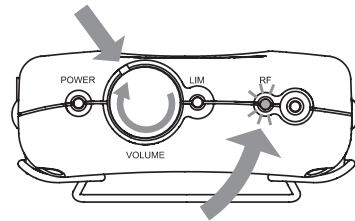

6. Check the RF LED on the top of the Receiver to confirm that it is receiving signal from the TransMixer.
7. Plug the Earphones into the earphone jack on the Receiver. Insert the Earphones into your ears.
8. Increase Receiver volume until the knob is turned to approximately 11 o'clock.

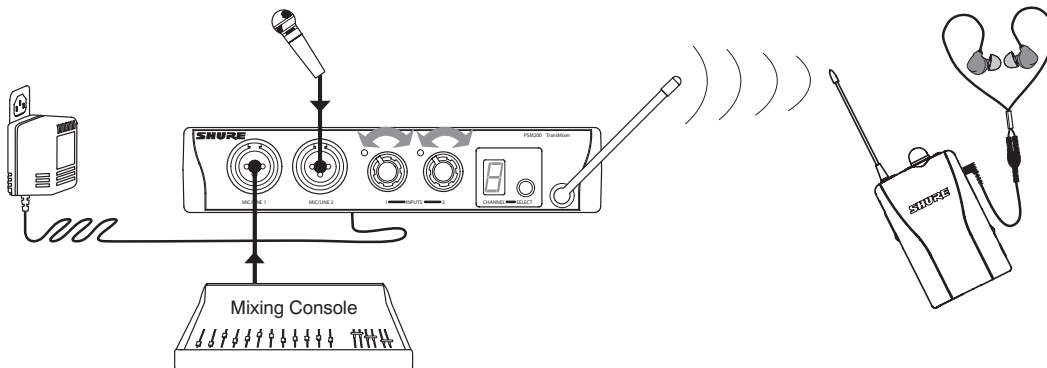

9. On the front panel of the TransMixer, adjust the signal level of each audio input with the INPUT knobs.
10. Check the INPUT LEDs on the TransMixer to verify that signal is present, but not clipping. See the *Audio Inputs and Outputs* section on page 6 for details.
11. Slowly adjust the Receiver volume to a comfortable level.

## PR2 Receiver Quick SetUp Guide

### When Used as a Wired Stand-Alone Personal Monitor

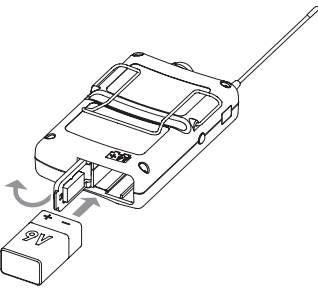

1. Insert a 9 Volt battery into the P2R Receiver, observing proper polarity.

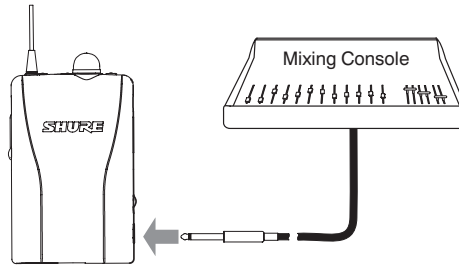

2. Connect an audio source to the 1/4-inch MIX IN jack on the side of the P2R.

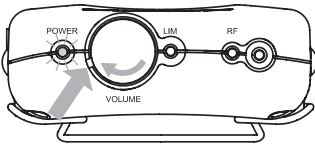

3. Turn the P2R volume knob on (past the click). Keep the volume at a low setting.

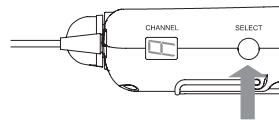

4. Set the CHANNEL to "A" with the SELECT Button. See the *Wired Mode* section on page 8 for details.

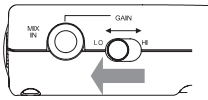

5. Set the GAIN switch to LO initially and set your source volume to a moderate level.

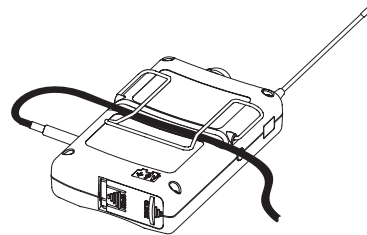

6. Attach the P2R onto your belt, waistband, or another location and slide the cable into the cable management groove on the back side of the unit.

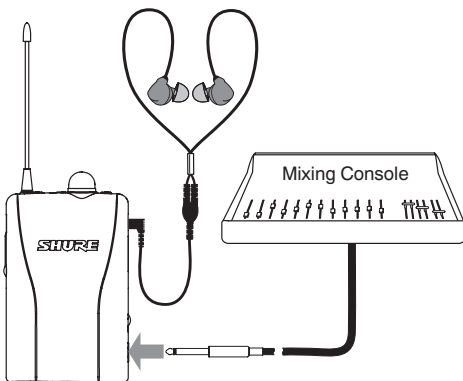

7. Plug Earphones into the earphone jack on the P2R. Insert the Earphones into your ears.
8. Slowly adjust the volume to a comfortable level. Set the GAIN switch to HIGH if the signal level is too low.

## INTRODUCTION

Thank you for buying the PSM200. Like all Shure PSM personal monitoring products, the PSM200 provides the many advantages of in-ear monitoring including:

- **Improved Sound Quality** —high fidelity without the risk of feedback
- **Increased Mobility** —your mix moves with you
- **Personal Control** —create a personal mix, and control your own levels

For information on this and other Shure products, visit [www.shure.com](http://www.shure.com) on the World Wide Web

### The PSM200 Personal Monitor System

The PSM200 is a frequency-agile, in-ear monitor system for use in a wide variety of applications. Its many features help overcome the difficulties associated with stage monitoring.

The P2R Receiver is the world's first bodypack receiver to function as a wired receiver, a wireless receiver, or both at the same time. This and other unique features, along with excellent sound quality, make the P2R an exceptional value.

The P2T TransMixer is another breakthrough design for in-ear monitoring. It allows the user to connect two line-level mic-

level inputs directly into the transmitter. The two signals can then be mixed independently. You can connect microphones or instruments directly to the inputs, use line outputs from a mixing console, or connect it to Shure's Aux-Pander. In short, no matter what the output device, you can probably plug it into the TransMixer.

The complete PSM200 System includes the SCL2 Earphones, which feature Dynamic MicroDrivers that produce crisp, full-spectrum sound. They include a variety of sleeve options to provide the best fit and isolation for your ears. The SCL2, like all Shure earphones, work well with CD players, MP3 players, and anything else with a 1/8-inch (3.5mm) stereo output.

## FEATURES

### PSM200 System

- 8 selectable UHF frequencies
- Includes SCL2 Dynamic MicroDriver earphones
- Mono mix
- Up to 4 systems can be operated simultaneously

### P2T TransMixer

- 2 mic/line XLR/1/4-inch combo inputs
- XLR SPLIT OUT connectors
- Input level controls
- Tri-color LED input level indicators

### P2R Receiver

- Combination wired/wireless compatibility
- Gain switch for setting line input sensitivity
- 1/4-inch line-level input jack to connect monitor mix, click-tracks, effects, or condenser microphones
- Integrated cable management groove secures cables connected to the bodypack

# THE P2T TRANSMIXER

## Controls and Features

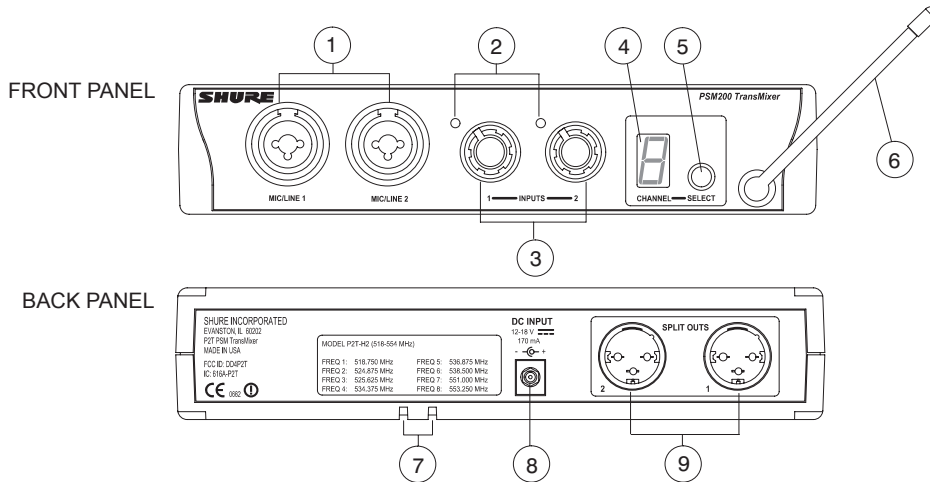

1. **MIC/LINE INPUT Jacks:** Electronically balanced inputs that accommodate both XLR and 1/4-inch connectors atomic or line levels.
2. **Signal/Clip LEDs:** Color indicates the signal status of the corresponding MIC/LINE input, as explained in the Audio Inputs and Outputs section below.
3. **INPUT Knobs:** Control the level of their corresponding inputs.
4. **CHANNEL LED Indicator:** Displays the frequency channel that is being transmitted (1-8).
5. **SELECT Button:** Press to select a frequency channel.
6. **Antenna:** Permanently mounted, break-resistant antenna transmits the mix to the P2R Receiver.
7. **Power Cord Strain Relief:** Thread the power cable through these slots to secure the DC connection.
8. **DC IN:** Plug the power supply into this connector. The unit remains powered on until you unplug it.
9. **SPLIT OUTS:** Each male XLR output jack duplicates the signal of the corresponding mic/line input. Front panel settings have no effect on split output level.

## Audio Inputs and Outputs

The INPUT knobs control both MIC and LINE level signals. As a general guide line, set the knob to the left of twelve o'clock for line level signals, and to the right of twelve o'clock for microphone levels.

Observe the signal/clip LEDs. If they are consistently red, decrease the level with the corresponding INPUT knob.



**NOTE:** If the level is decreased all the way and the LED remains red, the level of the input from the previous device in the audio chain (mixer, click track, digital sequencer, etc.) is too high and should be decreased.

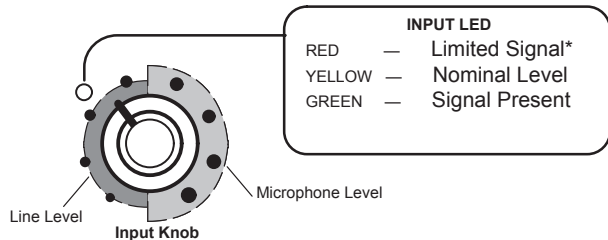

To pass audio signal directly through the TransMixer, use the corresponding SPLIT OUT on the rear panel of the device. Input setting do not affect the level of the signal at the SPLIT OUT connectors.

\* The P2T inputs have limiting circuitry that activates automatically when the input level is too high.

## Phantom Power

Although the TransMixer itself does not provide phantom power for condenser microphones, the SPLIT OUT connectors pass phantom power from a phantom power supply to a microphone connected to the corresponding input jack. You can connect equipment that supplies phantom power to the TransMixer without harming the unit.



**CAUTION:** Use a “direct box” when connecting guitars, keyboards, and other instruments to a mixing console through the P2T. The phantom power that mixing consoles provide for microphones can damage other instruments. Connect the instrument to the direct box then connect the direct box to the TransMixer input.

## Selecting a Frequency Channel

1. Press and hold the SELECT button until the CHANNEL LED indicator begins to flash.
2. When the LED indicator is flashing, press the SELECT button to scroll to the desired frequency channel.
3. Release the button. After 4 seconds the display will stop flashing and the P2T will automatically switch to the specified channel.



### IMPORTANT:

Never set more than ONE TransMixer to the same frequency channel, or interference will occur.

## P2R RECEIVER

### Controls and Features

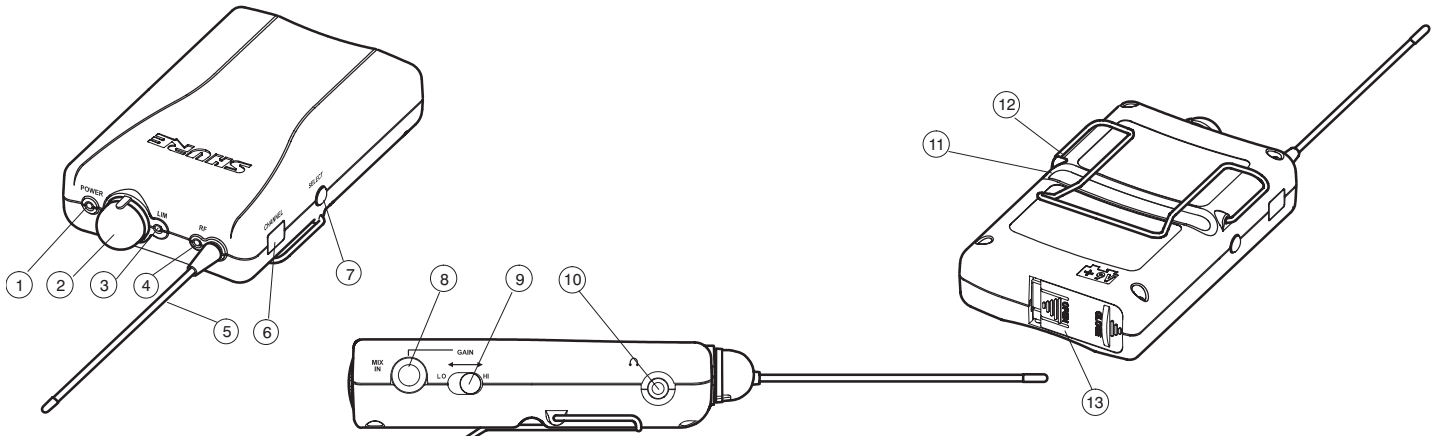

- 1. POWER LED:** Lights to indicate the unit is powered on and blinks to indicate low battery. When this LED starts blinking, you have approximately 15 minutes of battery time remaining, depending on volume level and battery brand.
- 2. On/Off/Volume Knob:** Turn clockwise past click to power on. Continue to turn clockwise to increase volume, counterclockwise to decrease volume.
- 3. LIM LED:** Lights only when limiter is activated. See the LIM LED section on page 8 for details.
- 4. RF LED:** Lights when the unit is receiving radio frequency(RF) signal from the P2T TransMixer.
- 5. Antenna:** An attached, flexible whip antenna receives RF signal from the TransMixer.
- 6. CHANNEL LED Indicator:** Displays the number of the current frequency channel (1-8), or the letter "A" for wired mode. The CHANNEL LED indicator shuts itself off after 10 seconds to conserve battery life. To view the frequency channel when the LED indicator is off, simply press and release the SELECT button.
- 7. SELECT Button:** Press to increment the frequency channel or set to "A" for wired mode.
- 8. MIX IN Jack:** Connect a 1/4-inch line-level input to this-jack. Use alone, or in combination with wireless reception from the P2T TransMixer. See the MIX IN Jack section on page 8 for details.
- 9. GAIN Switch:** Slide to HI or LO position to set the sensitivity of the MIX IN input.
- 10. Earphone Output Jack:** Connect SCL2 earphones to this 1/8-inch (3.5mm) jack.
- 11. Cable Management Groove:** For a secure connection, guide the cable connected to the MIX IN Jack or the ear-phone cord into this groove.
- 12. Belt Clip:** Securely attaches the unit to a belt, guitar strap or waist band.
- 13. Battery Compartment Door:** See the Battery Installation section below.

### Battery Installation\*

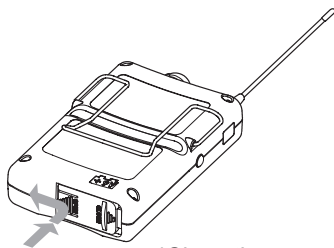

1. Unlock the battery compartment door by pressing down on the side of the battery compartment door marked "OPEN" and sliding it in the direction of the arrow.
2. Flip open the door and insert a fresh 9V alkaline battery, observing proper polarity.
3. Flip the battery compartment door closed, then press and slide the compartment door until it snaps shut.



**Note:** If the battery compartment door will not close completely, the battery is not correctly inserted.

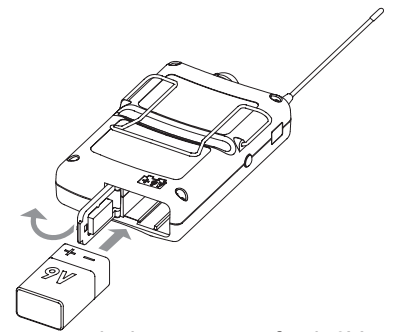

\*Since the average life of a battery varies depending on the manufacturer, Shure recommends that you use a fresh 9V battery for performances longer than two hours. You can then reserve used batteries for rehearsals or other less critical applications.

### Cable Management Groove

1. Connect an audio source to the 1/4-inch MIX IN jack on the side of the P2R.
2. Attach the P2R to your belt, waist band, or another location.
3. Slide the audio cable or earphone cord up into the groove, as illustrated.
4. The belt clip will hold them securely in place.

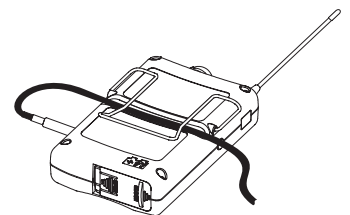



## Wireless Mode

When you are using the P2R as a wireless receiver, or as a combination wired and wireless receiver, use the SELECT button on the side of the P2R Receiver to set the frequency channel (1-8).

### To Select a Frequency Channel:

1. Press and hold the SELECT button until the CHANNEL LED indicator begins to flash.
2. When the LED indicator is flashing, press the SELECT button to scroll to the desired frequency channel.
3. Release the button. After 4 seconds the display will stop flashing and the P2R will automatically switch to the specified channel.

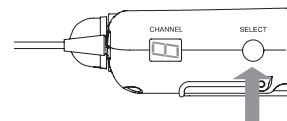

**NOTE:** Set the P2R to the same channel as the P2T TransMixer.

## Wired Mode

When you are using the P2R Receiver as a stand-alone wired monitor, you can set the unit to wired mode. This deactivates the RF circuitry and extends the battery life.

### To Set the P2R to Wired Mode:

1. Press and hold the SELECT button until the CHANNEL LED indicator begins to flash.
2. When the LED indicator is flashing, press the SELECT button to scroll past channel 8 until the letter "A" appears in the display.
3. Release the button. After 4 seconds the display will stop flashing and the P2R will automatically switch to wired mode.

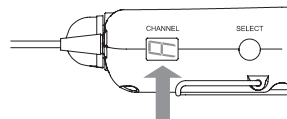

**NOTE:** Setting the P2R receiver to wired mode disables its wireless capability.

## Scanner Mode

When you are using the P2R as a wireless receiver, Shure recommends that during setup you first scan for a frequency channel that is free from interference:

1. Unplug the P2T TransMixer and turn off the P2R.
2. Hold down the P2R SELECT button while turning its volume knob past the click (ON).
3. Insert the earphones into your ears and slowly increase the P2R volume until you hear noise. The CHANNEL LED will blink to confirm the unit is in Scanner Mode.



**WARNING:** Increase the volume slowly, as the noise may be loud.

4. Scroll through the eight available frequencies to locate a clear channel. A channel is clear if you hear uninterrupted whitenoise from the P2R. Avoid channels that have no sound. This indicates interference on that frequency channel, which makes it unsuitable for use.
5. To exit scanner mode, simply turn off the P2R. When you turn the unit back on it will be set to the channel that you last selected.
6. Set the P2T to the same channel as the P2R.

## MIX IN Jack

When you are using the P2R Receiver as a stand-alone personal monitor, the 1/4-inch MIX IN jack serves as the primary audio input. In addition, the MIX IN jack allows the P2R to function as a hybrid wired and wireless receiver. When you are using the P2R in its wireless mode, you can add a second audio source via the MIX IN jack, such as:

- Click Tracks
- Pre-Amp Outputs from Guitar or Bass
- Effects Processors
- Condenser Microphones

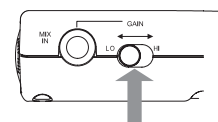

Next to the jack is a two-position GAIN switch that gives you a choice between LO and HI gain settings for the input. For specific information on how the MIX IN jack functions, refer to the wiring diagram on page 14.

## LIM LED

The P2R Receiver has a non-defeatable (constantly active) limiter that automatically activates if the receiver output level exceeds a certain volume, which is calibrated specifically for the Shure SCL2 earphones. The LIM LED on the top of the unit lights up when the limiter is on. If the LIM LED blinks occasionally, turn down the volume of the receiver.\* If the LED is on and you haven't reached a high enough listening level, try re-inserting the earphones for a better seal, or adjust the mix that is being sent to the receiver to include only the most essential inputs.\*\*

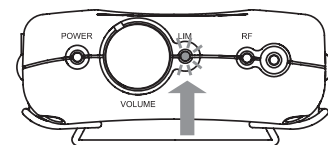

\* When the LED is on, the volume will not increase.

\*\*The limiter is designed to work best with the Shure SCL2 earphones. Using the P2R with other Shure earphones, or earphones made by other manufacturers, can result in higher limited volume levels.

## SETUP

### Wireless System Setup

To configure the P2T TransMixer and P2R Receiver for wireless operation:

1. Plug the power supply into the DC INPUT connector on the rear panel of the P2T, then plug it into a power outlet.
2. Connect audio sources to the combo XLR/1/4-inch jacks on the front panel.
3. Select a frequency channel (1-8). See the Selecting a Frequency Channel section on page 6 for details.



**IMPORTANT:** Never set more than ONE TransMixer to the same frequency channel, or interference will occur.

4. Observe the signal/clip LEDs. If they are consistently red, decrease the level with the corresponding INPUT level knob.

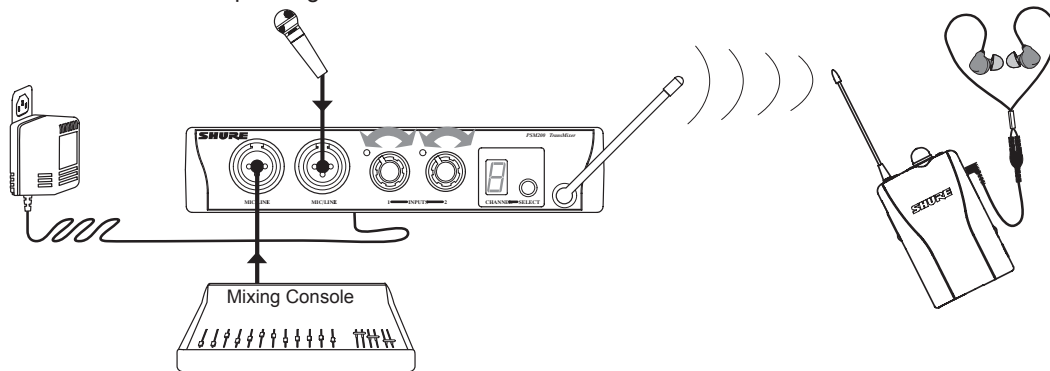

### Hybrid Wired/Wireless System Setup

To configure the P2T TransMixer and P2R Receiver for hybrid wired/wireless operation:

1. Follow steps 1-9 of the Wireless System Set-Up section.
2. Connect an audio source to the 1/4-inch MIX IN jack on the side of the P2R.
3. Set the GAIN switch to LO initially and set the source volume to a moderate level.
4. Attach the P2R onto your belt, waistband, or another location.
5. Slide the audio cable or earphone cord into the cable management groove.
6. Slowly increase the P2R volume to a comfortable level. Set the GAIN switch to HI if you need more level.

### P2R Stand-Alone Wired Set-Up\*

To configure the P2R Receiver as a stand-alone personal monitor:

1. Turn the On/Off/Volume knob clockwise past click (On). Leave the volume setting low.
2. Set the CHANNEL to "A" with the SELECT Button. See the Wired Mode section on page 8 for details.
3. Connect an audio source to the 1/4-inch MIX IN jack on the side of the P2R.
4. Set the GAIN switch to LO initially and set the source volume to a moderate level.
5. Attach the P2R onto your belt, waistband, or another location.
6. Slide the audio cable or earphone cord into the cable management groove.
7. Plug the earphones into the earphone output jack. Insert the earphones into your ears as instructed in the ear-phone user's guide.
8. Slowly increase the P2R volume to a comfortable level. Set the GAIN switch to HI if you need more level.

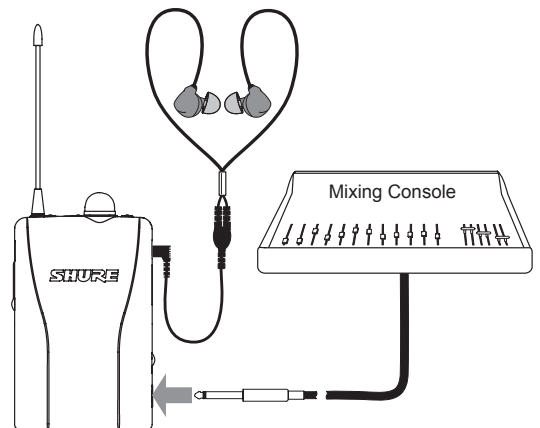

**NOTE:** Setting the P2R receiver to "A" disables its wireless capability and extends the battery life.

\* If you have purchased the P2R as a stand-alone personal monitor, you can go wireless by simply purchasing a P2T TransMixer.

## SYSTEM APPLICATIONS

This section presents three typical applications for the PSM200. For more ideas, visit Shure's website at [www.shure.com](http://www.shure.com).

### APPLICATION ONE: Wireless Setup for a Vocalist

This is the basic wireless configuration of the PSM200 system for a single user, either instrumental or vocal:

1. Connect the vocal mic to INPUT 1 of the P2T TransMixer.
2. Connect SPLIT OUT 1 from the P2T to the Mixing Console.
3. Connect the instrumental mix line out to INPUT 2 of the P2T.
4. Set the P2T and P2R to the same frequency channel.
5. Insert the SCL2 earphones into your ears and adjust the mix of INPUT 1 and INPUT 2 on the TransMixer.

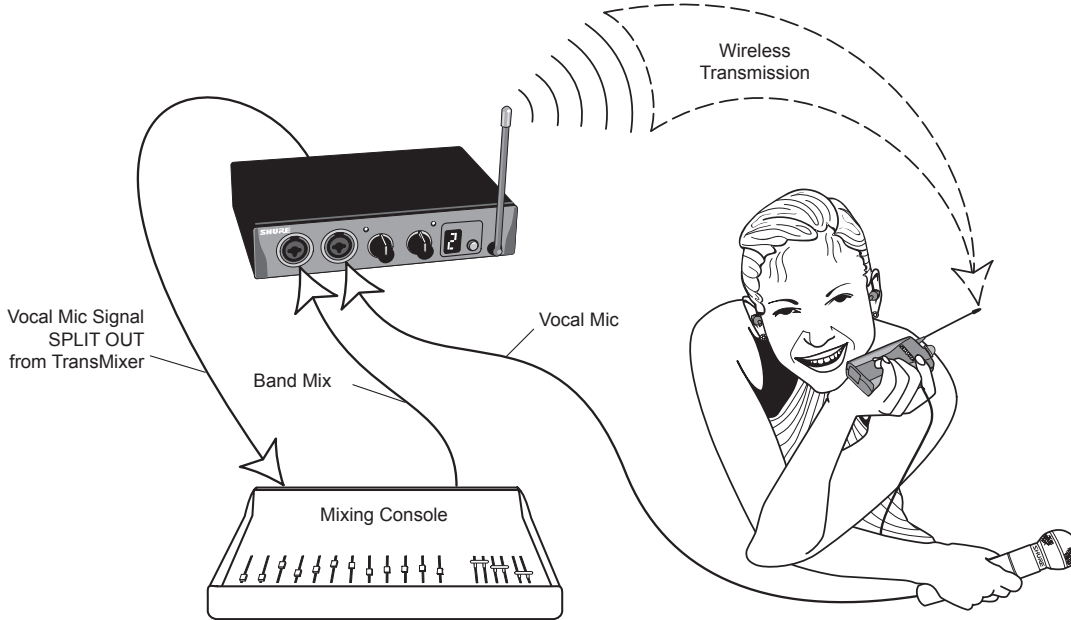

### APPLICATION TWO: Combination Wired and Wireless Setup for a Drummer

The following application uses the P2R as a combination wired/wireless Receiver. The MIX IN jack of the P2R is connected to a click track for the drummer:

1. Connect the drum mix out of the Mixing Console to INPUT 1 of the P2T TransMixer.
2. Connect the band mix out of the Mixing Console to INPUT 2 of the P2T.
3. Set the P2T and the P2R to the same frequency channel.
4. Insert the SCL2 earphones into your ears and adjust the mix of INPUT 1 and INPUT 2 on the TransMixer.
5. Set the P2R Receiver to a comfortable level.
6. Set the GAIN switch on the P2R to LO.
7. Connect the Click Output to the MIX IN 1/4-inch jack of the P2R and adjust your levels.

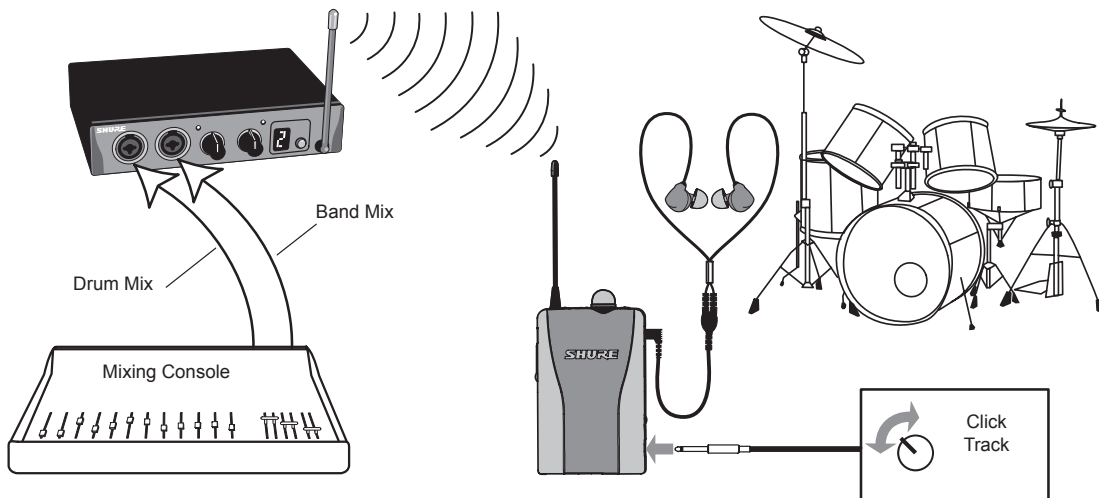

### APPLICATION THREE: Two PSM200 Wireless Systems Used Simultaneously\*

The following configuration uses two PSM200 systems simultaneously, and utilizes the SPLIT OUT feature of the TransMixer. In this example, the musicians keep the TransMixers on stage with them, in order to control their personal mixes independent of the house engineer.

1. Connect the vocal mic to INPUT 1 of the Vocal Mix TransMixer and connect SPLIT OUT 1 (the vocals) to the Mixing Console.
2. Connect the total band mix from the Mixing Console to INPUT 2 of the Vocal Mix TransMixer.

**NOTE:** In this example, the band mix includes vocals. This allows the guitar mix to include vocals, and allows the vocalist to independently control more of the vocal level in his/her personal mix.

3. Set the Vocal Mix P2T and P2R Receiver to the same frequency channel.
4. Connect SPLIT OUT 2 of the Vocal Mix TransMixer (the band mix) to INPUT 1 of the Guitar Mix TransMixer.
5. Connect the guitar amp simulator to INPUT 2 of the Guitar Mix P2T TransMixer.
6. Connect the SPLIT OUT 2 of the Guitar Mix TransMixer (the guitar amp simulator) to the Mixing Console.
7. Set the Guitar Mix P2T TransMixer and P2R Receiver to a frequency channel that's different from the channel you set for the Vocal Mix system in step 3.

\* Up to four systems can be used at the same time.

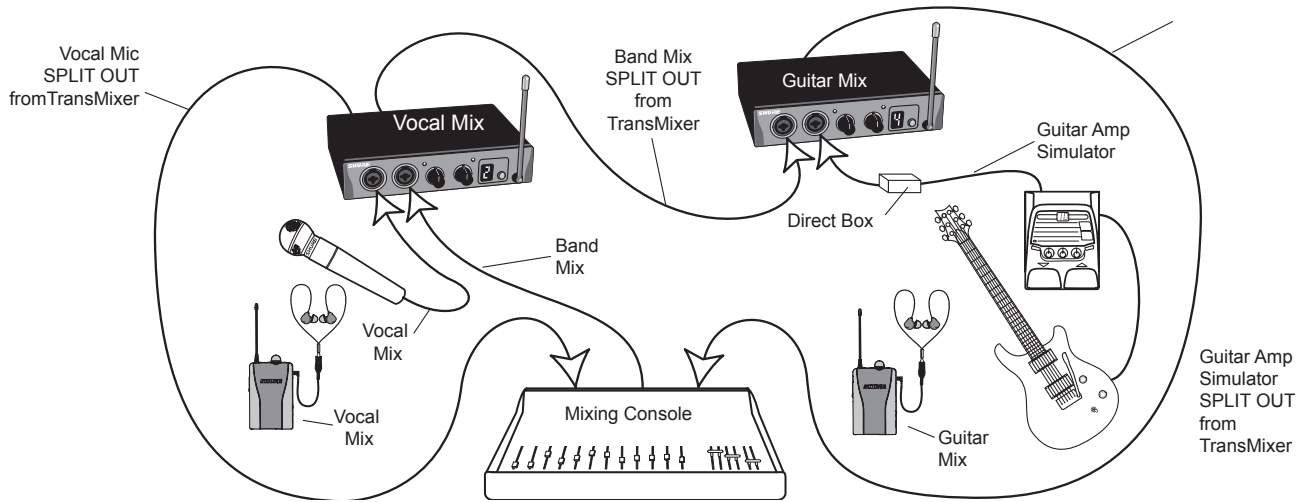

### RACK MOUNTING THE P2T

The P2T features a standard 1/2-rack space design, and includes a rack mounting kit.



**WARNING:** Do not torque the screws too tightly, or the chassis may be damaged.

#### Install Rack Ears

Single Unit

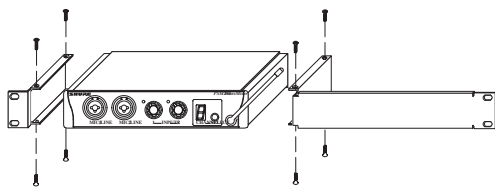

Mount in an Equipment Rack

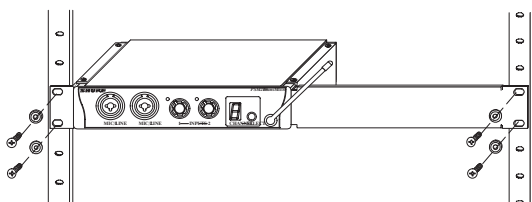

Dual-Mounting Two Units

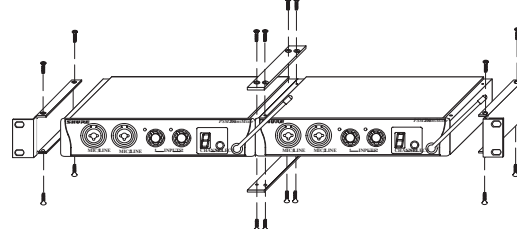

**NOTE:** Be sure to use both straddle bars when installing dual units.

## TROUBLESHOOTING

PROBLEM	SOLUTION
<b>No sound at the receiver</b>	<ul style="list-style-type: none"> <li>✓ Check the power cord on the TransMixer and make sure it is powered on.</li> <li>✓ Make sure both the TransMixer and the P2R Receiver are set to the same frequency channel.</li> <li>✓ Make sure the earphones are plugged in to the receiver and the volume is up.</li> <li>✓ Make sure the Receiver is on and the battery is good.</li> <li>✓ Check the incoming audio connections on the TransMixer.</li> </ul>
<b>Low receiver range</b>	<ul style="list-style-type: none"> <li>✓ Try to maintain line-of-sight between the TransMixer and Receiver antennas.</li> <li>✓ Try another frequency in case interference is limiting the range.</li> <li>✓ Check for television channel interference. More information is available at <a href="http://www.shure.com">www.shure.com</a>.</li> </ul>
<b>Receiver sounds fuzzy or distorted</b>	<ul style="list-style-type: none"> <li>✓ Make sure no other TransMixers or wireless transmitters are operating on your frequency.</li> <li>✓ Make sure the TransMixer input level is lighting yellow LEDs for optimum performance.</li> <li>✓ Make sure you are using a fresh battery in the P2R.</li> </ul>
<b>Low audio output at the receiver</b>	<ul style="list-style-type: none"> <li>✓ Make sure the TransMixer input level is lighting yellow LEDs for optimum performance.</li> <li>✓ Make sure the P2R Receiver's volume knob is up.</li> </ul>

## ACCESSORIES

### Furnished Accessories

#### P2T TransMixer

AC Adaptor .....	PS20, PS20E, PS20UK, PS20AR
Single Mount Rack Bracket .....	53A8484
Dual Mount Rack Bracket .....	53B8484
Straddle Bars .....	53A8443
Hardware Kit .....	90AD8100

### Optional Equipment

#### AuxPander:

The Shure AuxPander auxiliary expander extends the capabilities of a standard mixing console by providing eight additional auxiliary sends. It is designed ideally for use with multiple personal monitoring systems.

#### P2R Receiver:

1/4-inch mono 20 foot cable ..... 90B4677

#### P4M:

The P4M is a highly versatile four-channel, two-bus stereo mic/line mixer designed to optimize personal (in-ear) monitor systems in live performance applications.

## SPECIFICATIONS

### PSM200 System

#### RF Carrier Frequency Range

518-865 MHz (country dependent)

#### Operating Range

100 m (300 ft.) under optimal conditions

#### Audio Frequency Response

30 Hz to 12 kHz (+/-3 dB); earphone dependent

#### Total Harmonic Distortion (1 kHz)

<1.5% typical (Ref. ±35 kHz deviation)

### P2T TransMixer

#### RF Output Power

30 mW (+15 dBm) typical conducted (country dependent)

#### Modulation Limiter

Internal peak limiter (>10:1 hard knee compression)

#### Antenna

1/4 Wavelength, semi-rigid, PCB Mount

#### Modulation

FM ±35 kHz Deviation (Nominal)

#### Signal-to-Noise Ratio

80 dB typical (A-weighted)

#### Operating Temperature

-7° C to +49° C  
(+20° F to +120° F)

#### Current

170 mA maximum

#### Dimensions

220 mm x 140 mm x 40 mm (8.6 in. x 5.6 in. x 1.7 in.)

#### Net Weight

370 g (13 oz.)

**P2T Audio Input**

<b>Connector Type:</b>	XLR/1/4-inch combo
<b>Configuration:</b>	electronically balanced
<b>Actual Impedance:</b>	1 kΩ
<b>Nominal Input Level:</b>	-25 dBu @ 1/2 volume (12 o'clock)
<b>Maximum Input Level:</b>	-5 dBu @ 1/2 volume (12 o'clock)
<b>Pin Assignments:</b>	XLR:2=hot; 3=cold, 1=ground 1/4:Tip = hot, Ring = cold, Sleeve=ground
<b>Phantom Power Protection?</b>	Yes:Up to 52 Vdc

**P2R Receiver**

**RF Sensitivity**

-109dBm typical

**Squelch Threshold**

-102dBm typical

**Antenna**

Attached Whip

**Audio Input Connector**

<b>Connector Type:</b>	1/4-inch Mono
<b>Impedance:</b>	1 MΩ
<b>Maximum Input Level:</b>	LO=+0 dBu HI = -10 dBu
<b>Frequency Response:</b>	30 Hz to 20k Hz (+/-3dB); earphone dependent

**P2T AudioOutputs**

Passive connection parallel with input.

<b>Connector Type:</b>	XLR
<b>Configuration:</b>	electronically balanced
<b>Pin Assignments:</b>	2= hot ; 3 = cold, 1 = ground
<b>Phantom Power Protection?</b>	Yes: Up to 52 Vdc

**Power Requirements**

Operating voltage 12-18 Vdc

Supplied with one of the following external power supplies:

- Model PS20: 120 VAC, 60Hz input.
- Model PS20E, Model PS20UK: 230 VAC, 50/60Hz input.
- Model PS20AR: 220 VAC, 50Hz input.

**Power Requirements**

9 V alkaline battery, recommended

**Battery Life**

Volume Dependent

Wired (RF Off):	6 Hours
Wireless (RF On):	4 hours

**Audio Output Connector**

1/8 inch (3.5mm)

**Minimum Load Impedance**

8Ω

**Net Weight**

100 g (3.52oz.), less battery

**Overall Dimensions**

122 mm x 73 mm x 32 mm

(4.809 in.x2.875 in.x1.251in.)

**PSM200Channel Frequencies**

The PSM200 is available in four frequency groups,each coordinated to work in a specific geographic region.You can find the frequency group for your system printed on the rear panel of the P2T TransMixer. For more information on which frequencies can be used in your area, call our Applications Group at 847-600-8440, Shure Europe at 49-1731-72140, Shure Asia at 852-2893-4290, or visit theTechnical Support section at [www.shure.com](http://www.shure.com).

CHANNEL	H2 (518-554) MHz North America, Europe	R8 (800-814) MHz Europe	Q3 (748-784) MHz France, Australia	S5 (842-865) MHz England
1	518.750	801.100	749.100	855.275
2	802.325	802.325	754.025	856.175
3	525.625	805.050	756.000	857.625
4	534.375	808.600	765.900	858.200
5	536.875	810.550	765.900	863.075
6	538.500	811.600	775.000	863.625
7	551.000	813.300	778.775	864.425
8	553.250	813.800	781.900	864.850
Channel A (P2R Only)	<b>Wired Mode (RF Disabled)</b>			

## Certifications

**P2T:** Certified to FCC Part 74 (FCC ID No. DD4P2T). Certified in Canada by IC to RSS-123 and RSS-102 (Certification No. 616A-P2T). This class B digital apparatus complies with Canadian ICES-003.

**EP2T/UKP2T:** Meets essential requirements of European R&TTE Directive 99/5/EC, eligible to bear the CE mark:  0682 ①

Type approved to EN 300 422 Parts 1 and 2. Meets requirements of EMC Standard EN 301 489 Parts 1 and 9.

**P2R:** Approved under the Declaration of Conformity (DoC) provision of FCC Part 15. Certified in Canada by IC to RSS-123 (Certification No. 616A-P2R). This class B digital apparatus complies with Canadian ICES-003. Meets essential requirements of European Union R&TTE Directive 99/5/EC, eligible to bear  mark. Meets requirements of EMC standards EN 300 422 Parts 1 and 2 and EN 301 489 Parts 1 and 9.

**PS20:** Conforms to applicable U.S. and Canadian electrical and safety standards.

**PS20E/PS20UK:** Conforms to European low voltage directive 72/23/EEC. Eligible to bear CE marking.



The term "IC:" before the radio certification number only signifies that Industry Canada technical specifications were met.

## APPENDIX

### P2R Receiver MIX IN Jack Wiring Diagram

#### Mono Line Input

The MIX IN jack accepts line-level signals, such as click tracks, effects processors, pre-amp outputs from guitar or bass amps, or line outputs from mixing consoles. When used with a mono connector, the ring of the MIX IN jack is grounded. This doesn't harm the P2R.

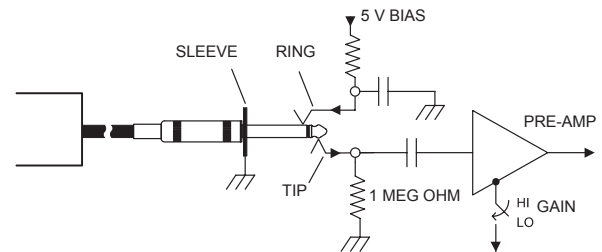



## DECLARATION OF CONFORMITY

We of

Shure Incorporated  
5800 Touhy Ave  
Niles, Illinois 60714, U.S.A.  
847-600-2000

declare under our sole responsibility that the following product

Model: **P2R**

Name: **UHF Wireless Microphone Receiver**

was tested and found to comply with Part 15 of the FCC rules.

Operation is subject to the following two conditions: (1) this device may not cause harmful interference, and (2) this device must accept any interference received, including interference that may cause undesired operation.

Shure Inc., Manufacturer:

Signed: Craig Kozokar Date: MARCH 1, 2007

Name, Title: Craig Kozokar, EMC Project Engineer, Global Compliance, Shure Inc.

**Note:** This equipment has been tested and found to comply with the limits for a Class B digital device, pursuant to part 15 of FCC Rules. These limits are designed to provide reasonable protection against harmful interference in a residential installation. This equipment generates, uses and can radiate radio frequency energy and, if not installed and used in accordance with the instructions, may cause harmful interference to radio communications. However, there is no guarantee that interference will not occur in a particular installation. If this equipment does cause harmful interference to radio or television reception, which can be determined by turning the equipment off and on, the user is encouraged to try to correct the interference by one or more of the following measures:

- Reorient or relocate the receiving antenna.
- Increase the separation between the equipment and the receiver.
- Connect the equipment into an outlet on a circuit different from that to which the receiver is connected.
- Consult the dealer or an experienced radio/TV technician for help.



**DECLARATION OF CONFORMITY**

We of

Shure Incorporated  
5800 Touhy Ave  
Niles, Illinois 60714, U.S.A.  
847-600-2000

declare under our sole responsibility that the following product

Model: **P2R**

Name: **UHF Wireless Microphone Receiver**

was tested and found to comply with Part 15 of the FCC rules.

Operation is subject to the following two conditions: (1) this device may not cause harmful interference, and (2) this device must accept any interference received, in interference that may cause undesired operation.

Shure Inc., Manufacturer:

Signed: Craig Kozokar Date: MARCH 1, 2007

Name, Title: Craig Kozokar, EMC Project Engineer, Global Compliance, Shure Inc.

**EU DECLARATION OF CONFORMITY**

We,  
of

Shure Incorporated  
5800 Touhy Avenue  
Niles, Illinois, 60714-4608 U.S.A.  
Phone: (847) 600-2000  
Web: [www.Shure.com](http://www.Shure.com)

Declare under our sole responsibility that the following product

Model: **P2T** Description: **TransMixer**

conforms to the essential requirements of  
European R&TTE Directive 1999/5/EC

The product complies with the following product family, harmonized or national standards:  
EN 301 489 Part 1 and 9, ETSI 300 422 1 and ETSI 300 422-2  
EN 60065, EN61000-3-2, EN 61000-3-3

The technical documentation is kept at:

Shure Incorporated, Corporate Quality Engineering Division  
SHURE Europe GmbH, EMEA Approval

Manufacturer: Shure Incorporated

Signed: Craig Kozokar Date: 16 November 2004  
Name and Title: Craig Kozokar, EMC Project Engineer, Corporate Quality Engineering Division

European Representative: SHURE Europe GmbH

Signed: Wolfgang Bilz Date: 16 November 2004  
Name and Title: Wolfgang Bilz, Dipl. Ing. (FH), EMEA Approval

SHURE Europe GmbH  
Headquarters Europe, Middle East & Africa  
Wannenäcker Str. 28  
D-74078 Heilbronn, Germany  
Phone: +49 - (0)7131 - 7214 - 0  
Fax: +49 - (0)7131 - 7214 - 14



**United States:**  
Shure Incorporated  
5800 West Touhy Avenue  
Niles, IL 60714-4608 USA

Phone: 847-600-2000  
Fax: 847-600-1212  
Email: [info@shure.com](mailto:info@shure.com)

**Europe, Middle East, Africa:**  
Shure Europe GmbH  
Wannenäckestr. 28,  
74078 Heilbronn, Germany

Phone: 49-7131-72140  
Fax: 49-7131-721414  
Email: [info@shure.de](mailto:info@shure.de)

**Asia, Pacific:**  
Shure Asia Limited  
Unit 301, 3rd Floor  
Citicorp Centre  
18, Whitfield Road  
Causeway Bay, Hong Kong

Phone: 852-2893-4290  
Fax: 852-2893-4055  
Email: [info@shure.com.hk](mailto:info@shure.com.hk)

**Canada, Latin America,  
Caribbean:**  
Shure Incorporated  
5800 West Touhy Avenue  
Niles, IL 60714-4608 USA

Phone: 847-600-2000  
Fax: 847-600-6446  
Email: [international@shure.com](mailto:international@shure.com)