

POWERED MIXER
EMX2 Owner's Manual

Introduction

Thank you and congratulations on your purchase of the Yamaha Powered Mixer EMX2. Please read this manual thoroughly to get the most out of the product and ensure long-term, trouble-free use. After reading this manual, keep it readily available for future reference.

* Please read the "Precautions" on the back.

Main Features

- 500-watt power amplifier for versatility in a wide variety of performance applications
- 10-channel mixer with four mono mic/line and three stereo line input channels, supporting a wide range of inputs
- Yamaha's high-quality SPX reverb, providing optimum processing for instruments or vocals
- Feedback Suppressor, which automatically cuts and prevents undesirable feedback noise
- Independent three-band equalizer on each channel for tonal adjustment and sound control

Accessories (Please check that they are included with your powered mixer.)

- AC power cord (2 m)
- Technical Specifications (English only): Includes general specifications, input/output characteristics, a block diagram, dimensions, and a jack and plug list.
- Owner's Manual (this leaflet)

Quick Start Guide

Setup

- 1 Make sure that all switches, including the mixer's power switch , are not on .

Connecting speakers, microphones, instruments, and audio devices

- 2 Refer to the connection example in the illustration below.

Connection Example

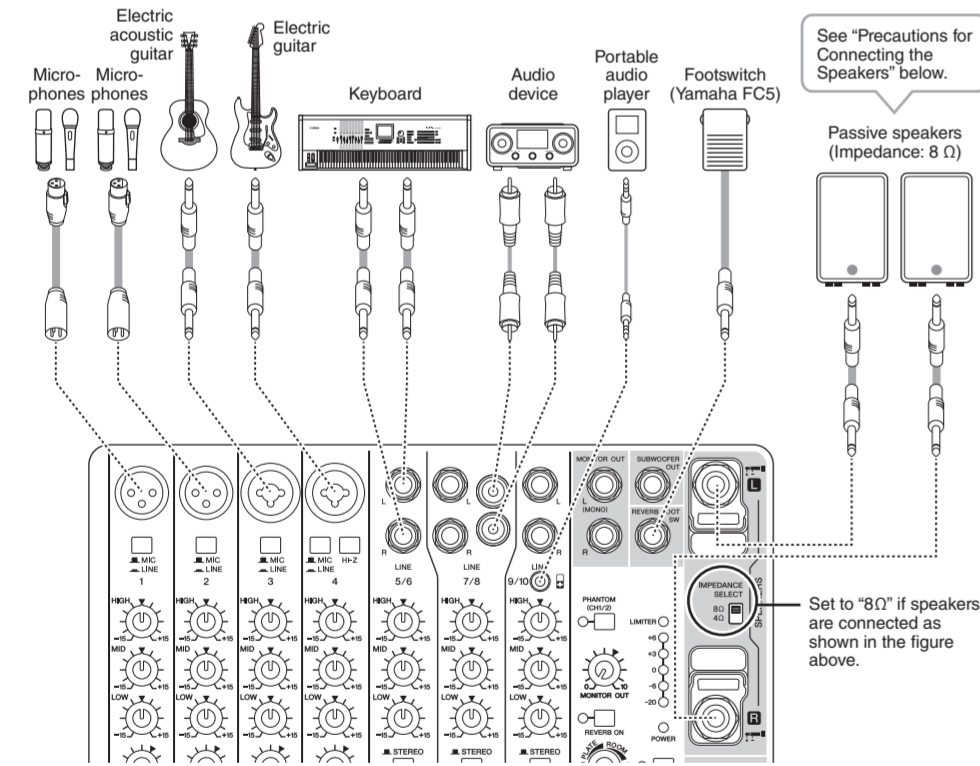

Precautions for Connecting the Speakers

You must set the [IMPEDANCE SELECT] switch correctly according to the connection method and number of speakers. Be sure that the impedance of your speakers is no less than the impedance that you set on the mixer. Setting this switch incorrectly could result in damage to the mixer/your speakers.

Actual speaker impedance*	[IMPEDANCE SELECT] switch
4 Ω to less than 8 Ω	Set to "4Ω."
8 Ω and over	Set to "8Ω."
If you are unsure of the impedance of the connected speakers	Set to "4Ω."

* For parallel connections: synthetic impedance

- Make sure to insert the speaker cables all the way inside until secure. Failure to do so may result in damage to your equipment.
- Use speaker cables with an insulated-housing connector.

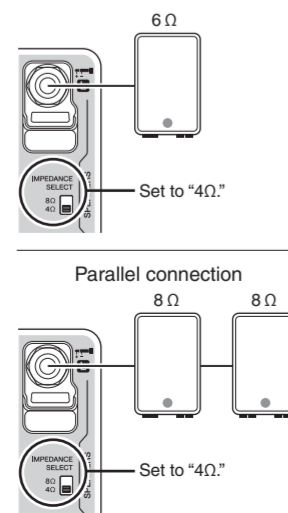

Getting sound to the speakers

- 3 Connect the included power cord.

First, connect it to the mixer's [AC IN] jack, then to a power outlet.

NOTE Reverse the order when removing the power cord.

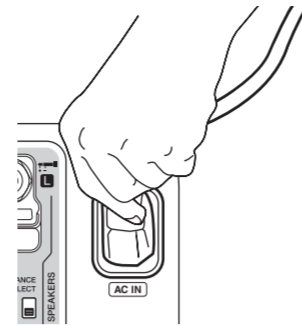

- 4 Turn the mixer's [LEVEL] controls (white knobs) and [MASTER LEVEL] control (red knob) to the minimum (zero). Also, set the equalizer controls (green knobs) to the center "▼" or "MUSIC" position.

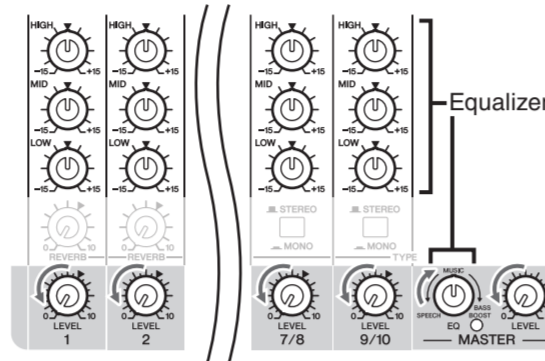

- 5 Set the [MIC / LINE] switch to the "MIC" position for microphone connection, and to the "LINE" position for connection of an instrument or audio device.

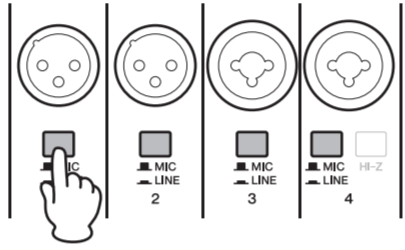

NOTE If you are using condenser microphones, turn on the [PHANTOM (CH1/2)] switch.

- 6 Turn on the power of the connected sound source (if applicable), then the mixer.

The [POWER] LED lights.

WARNING

To avoid any loud, unexpected noise from the speaker, first turn off the power to the mixer, then the connected sound source (such as an instrument or audio device).

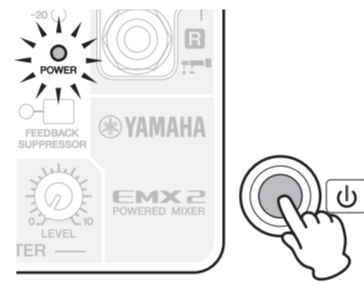

- 7 For channels to which a microphone, instrument, or audio device is connected, set [LEVEL] to the "▼" position.

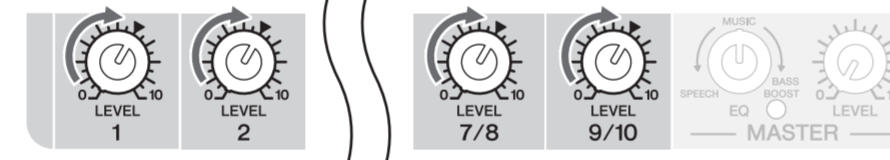

- 8 While outputting sound from the microphone, instrument, or audio device, slowly turn the [MASTER LEVEL] to the right until you reach the optimal volume.

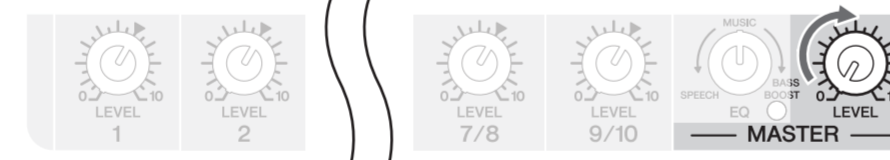

- 9 Adjust [LEVEL] on each channel as necessary to set the volume balance between the microphone, instrument, and audio device.

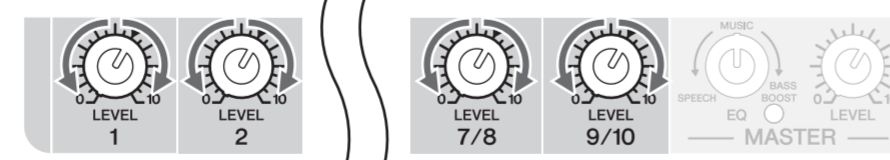

Making optimum volume settings

When the volume is too loud

Turn the [LEVEL] control to the minimum (zero). Set the [MIC / LINE] switch to the "LINE" position, then slowly raise the [LEVEL] control until the desired volume is reached.

When the volume is too soft

Turn the [LEVEL] control to the minimum (zero). Set the [MIC / LINE] switch to the "MIC" position, then slowly raise the [LEVEL] control until the desired volume is reached.

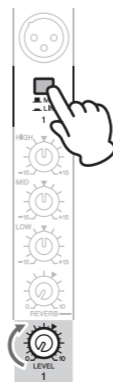

Applying Reverb

The EMX2 features a built-in reverb processor that is in the same league as our famed SPX effect processor series. This reverb lets you simulate the acoustics of different performance environments, such as concert halls and small clubs, and add warm, natural ambience to your vocals or instrument performance.

- 1 Press the [REVERB] button to turn it on. The LED lights when REVERB is on.

- 2 Turn the REVERB [TYPE/TIME] control to the desired reverb type and time (length).

Turning the control to the right lengthens the time of the selected reverb type.

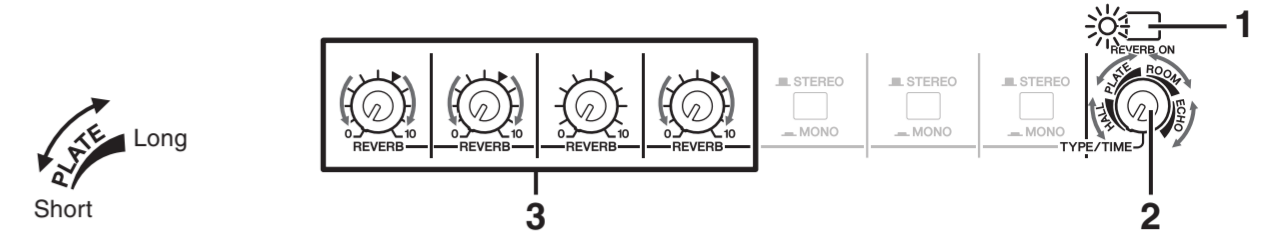

Controls and Functions

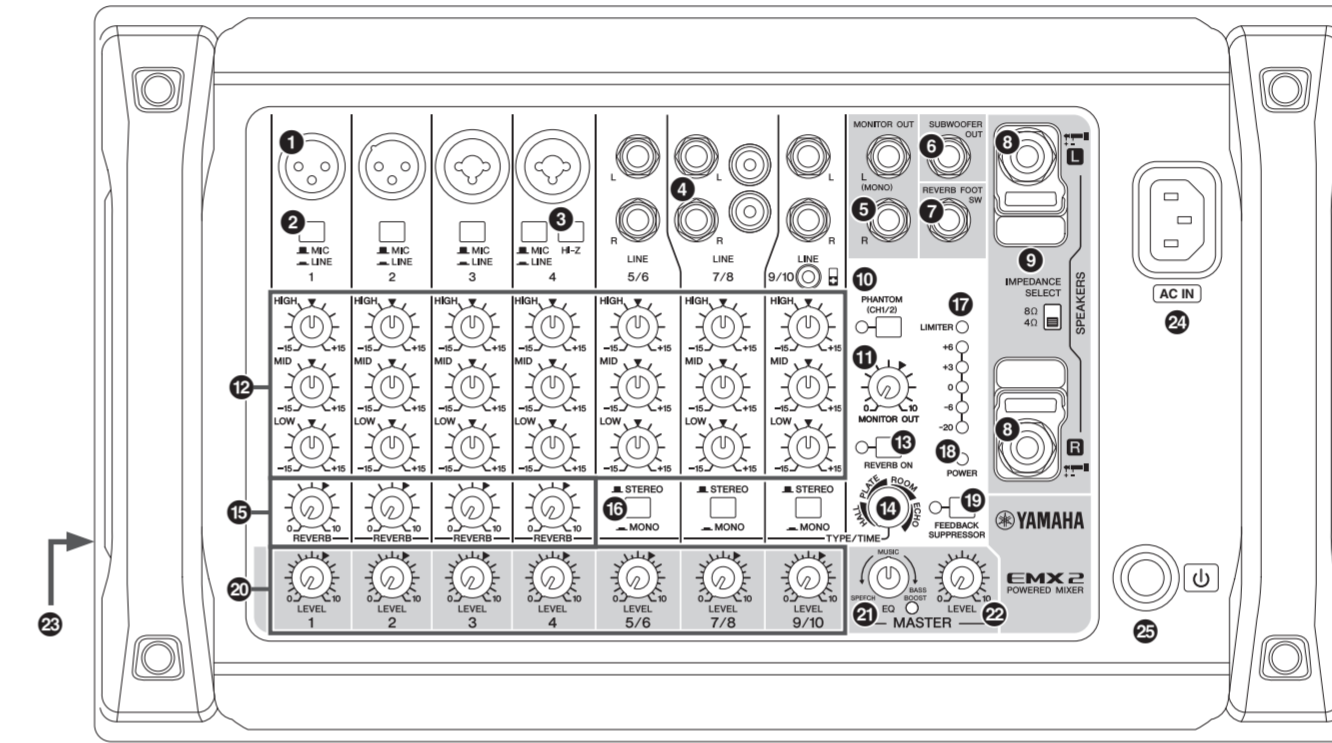

- 1 Mic/Line input jacks (channels 1–4)

Connect microphones, guitars, electronic musical instruments or audio devices. Channels 3 and 4 provide combo jacks that support both XLR and phone plugs.



- 2 [MIC / LINE] switches (channels 1–4)

For low-level signals (including microphones), set the switch to the "MIC" position. For high-level signals (including electronic instruments and audio devices), set the switch to the "LINE" position.

- 3 [Hi-Z] switch (channel 4)

This switch is used when connecting a device directly to the mixer without a DI (direct injection box) — for example, instruments with passive pickups, such as an acoustic-electric guitar or electric bass without battery. This function is effective only for the phone jack input.

- 4 [LINE] input jacks (channels 5/6, 7/8, 9/10)

Connect line-level devices such as electronic instruments, acoustic-electric guitars, CD players, and portable audio players. These jacks support phone, RCA-pin, and stereo-mini plugs.



NOTE For the channel 7/8 input, if both phone and RCA-pin jacks are used at the same time, the phone jack will take priority. For the channel 9/10 input, if both phone and stereo-mini jacks are used at the same time, the stereo-mini jack will take priority. The signal from the device connected to another jack will be muted.

- 5 [MONITOR OUT] jacks

These are for connection to a powered speaker for monitoring purposes, and output a mix of the signals from channels 1 to 9/10. You can adjust the output level using the [MONITOR OUT] control . If only the L (MONO) jack is used, the signals from the L and R channels are mixed and output.

- 6 [SUBWOOFER OUT] jack

This is for connection to a powered subwoofer, and outputs a mono signal. If this jack is in use, the low frequencies below 120 Hz to the [SPEAKERS L/R] jacks will be cut. The output level is linked to that of the [MASTER LEVEL] control .

- 7 [REVERB FOOT SW] jack

This is for connection to an unattached-type footswitch such as the Yamaha FC5 — useful for solo performers, since you can toggle the reverb on and off as needed with your foot.

- 8 [SPEAKERS L/R] jacks

Use commercially available speaker cables to connect the speakers.

- 9 [IMPEDANCE SELECT] switch

Set this switch to match the impedance of the connected speakers. If you are unsure of the impedance of the connected speakers, set this switch to "4Ω". Changing this setting changes the maximum output from the amp and changes the conditions for which the [LIMITER] LED comes on.

NOTICE

- Make sure the power switch is off before changing the setting of this switch.
- Setting this switch incorrectly could result in damage to the mixer/your speakers.

- 10 [PHANTOM (CH1/2)] switch/LED

When this switch is on, the LED lights indicating that phantom power is available for channels 1 and 2. Turn this switch on to supply power to condenser microphones or a DI (direct injection box).

NOTICE

- Follow the important precautions below, in order to prevent noise and possible damage to external devices and the mixer when you operate this switch.
- Be sure to leave this switch off if you do not need phantom power, or when you connect a device that does not support phantom power to channels 1 and 2.
- Do not connect/disconnect a cable to/from channel 1 or 2 while this switch is on.
- Turn the [LEVEL] control of channels 1 and 2 to the minimum before operating this switch.

- 11 [MONITOR OUT] control

Determines the signal level output from the [MONITOR OUT] jacks . The [MASTER LEVEL] control does not affect the [MONITOR OUT] signal.

- 12 Equalizer controls [HIGH, MID, LOW]

The equalizer shapes the [HIGH], [MID], and [LOW] audio frequencies. Turning the control to the right amplifies (boosts) the corresponding frequency band, while turning it to the left attenuates (cuts) the band. Setting the control to the "▼" position produces a flat response in the corresponding band.

- 13 [REVERB] button/LED

When this button is on, the LED lights indicating that you can apply reverb. This button is off when you turn on the mixer. (Unlike other switches, this button cannot be locked.)

- 14 REVERB [TYPE/TIME] control

Determines the reverb type and its length. Turning the control to the right lengthens the time of the selected reverb type. "HALL": Simulated reverb of a large space, such as a concert hall.

"PLATE": Simulated metal plate reverb, producing a more hard-edged and bright sound.

"ROOM": Simulated acoustic ambience of a small room.

"ECHO": Echo effect suitable for vocals.

- 15 [REVERB] controls (channels 1–4)

Determines the amount of reverb for each channel when the [REVERB] button is on.

- 16 [STEREO / MONO] switches (channels 5/6, 7/8, 9/10)

Setting the switch to "STEREO" will assign the signals from the L and R channels to each left and right speaker and output each signal. Setting the switch to "MONO" will mix the output of different L and R sources to output the same signal to both the left and right speakers. For keyboards with mono output, guitars, or other non-stereo sound sources, when the switch is set to "MONO", the stereo jacks can be conveniently used as multiple mono jacks.

- 17 Level meter

The level meter shows the level of output signal from the [SPEAKERS L/R] jacks.

NOTICE

If used at a high volume so that the [LIMITER] LED flashes continuously, the internal power amplifier section is being excessively overloaded and may malfunction. Reduce the output level with the [MASTER LEVEL] control so that the indicator flashes only briefly on the highest transient peaks.

- 18 [POWER] LED

This LED lights when the power is turned on by pressing the power switch.

- 19 [FEEDBACK SUPPRESSOR] switch/LED

When this switch is on, the LED lights indicating that feedback is automatically suppressed. (This utilizes a seven-band notch filter. When this switch or the power switch is off, the notch filter will be reset.)

- 20 [LEVEL] controls

Use these controls to adjust the volume for each channel. To reduce noise, set any [LEVEL] controls on unused channels to the minimum.

- 21 [MASTER EQ] control

Use this control to adjust the overall sound frequency balance. The center position "MUSIC" is a basic setting and if you turn the control to the left, this creates an optimum setting for speech, cutting unneeded low range frequencies. If you turn the control to the right, it creates an optimum setting for playback of sound sources, since the low range is boosted. If you turn the control further to the right, the [BASS BOOST] LED lights indicating that the bass boost function is active, giving you an even more powerful bass tone.

- 22 [MASTER LEVEL] control

Determines the volume of the signal output from the [SPEAKERS L/R] and [SUBWOOFER OUT] jacks. This allows you to adjust the overall volume without changing the relative volume balance among the various channels.

- 23 Vents

There are vents located on both sides of the mixer, and a cooling fan is installed on the exhaust side. Do not block the vents on either side when using the mixer.

- 24 [AC IN] jack

Connect the included power cord here.

- 25 (Power) switch

For turning the power of the mixer on and off .

NOTICE

Rapidly turning the mixer on and off in succession can cause it to malfunction. After turning the mixer off, wait for about 10 seconds before turning it on again.

Rack Mounting

- 1 Use a screwdriver to loosen and remove the screws (4) on the handles installed on the mixer.

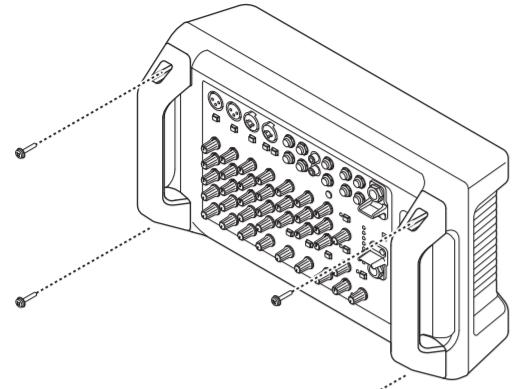

NOTE The EMX2 requires at least 6 U of rack space. To take into account the cable connections, we recommend to ensure 7 U of rack space.

Precautions for Rack Mounting

This mixer is rated for operation at ambient temperatures ranging from 0 to 40 degrees Celsius. If you install this mixer along with other devices in a poorly ventilated EIA standards rack, the ambient temperature inside the rack may rise, resulting in inefficient performance. Be sure to rack-mount in the following conditions so the mixer does not overheat.

Mounting to a Microphone Stand

The mixer can be mounted onto a microphone stand as illustrated at right, by using the optionally available Yamaha BMS-10A Mic Stand Adaptor. For instructions on mounting, refer to the BMS-10A Owner's Manual.

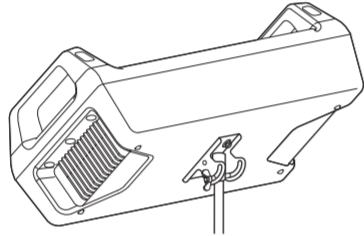

Troubleshooting

Check the following items before contacting a Yamaha dealer. If the symptoms are not improved, contact your nearest Yamaha dealer.

Power does not come on.

- Did you firmly and securely connect the power cord?

Power shuts down suddenly.

- Are the vents of the mixer blocked? Since inadequate ventilation can result in overheating the mixer, the power may be turned off automatically to prevent overheating. Ensure proper ventilation for cooling, and then turn on the power again.

No sound is heard.

- Did you connect the mixer's [SPEAKERS L/R] jacks and the speakers' input jacks using the proper speaker cables?
- Did you firmly and securely connect the speaker cables?
- Is the [POWER] LED flashing at intervals?

There may be a short in the speaker cable or the connection may be faulty. Check that the speaker cable is not scratched and is connected properly to the mixer, and then turn the power on again.

- For channels 7/8, are both phone and RCA-pin jacks connected at the same time? Or, for channels 9/10, are both phone and stereo-mini jacks connected at the same time?

The phone jack has priority for channels 7/8 and the stereo-mini jack has priority for channels 9/10.

- Is the [POWER] LED flashing continuously?

If the internal power amplifier section is excessively overloaded, the amplifier will be muted for protection. The mixer will automatically reset itself after a while.

The high sounds and low sounds are unbalanced.

- Are the equalizer controls raised or lowered too much? Set the equalizer controls to the center position.

2 Use the screws you removed in Step 1 to securely install the RK-EMX2 Rack-Mount Kit (sold separately) on the mixer.

Orient the RK-EMX2 rack-mount brackets with the engraved lettering facing toward the rear.

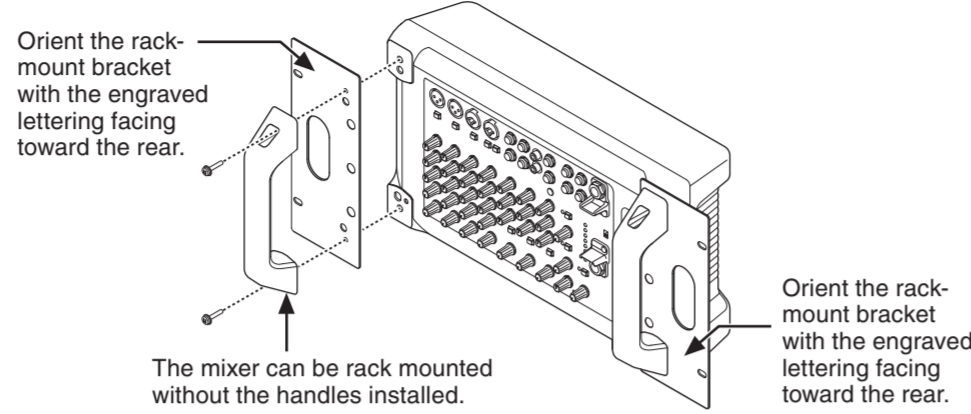

NOTICE Be sure to use the screws removed in Step 1. Using other screws can cause damage.

NOTE Separate screws for mounting the mixer in a rack are not included with the mixer.

- When mounting the mixer in a rack with devices such as power amplifiers that generate a significant amount of heat, leave more than 1U of space between it and other equipment. Also, either leave the open spaces uncovered or install appropriate ventilating panels to minimize the possibility of heat buildup.
- To ensure sufficient airflow, leave the rear of the rack open. If you've installed a fan kit in the rack, there may be cases in which closing the rear of the rack will produce a greater cooling effect. Refer to the rack and/or fan kit manual for details.

General Specifications

Maximum Output Power (1 kHz)	THD+N<10% 250 W + 250 W (4 Ω), 170 W + 170 W (8 Ω) THD+N<1% 110 W + 110 W (4 Ω), 110 W + 110 W (8 Ω)
Input Channels	10 channels (Mono (MIC/LINE): 4, Stereo (LINE): 3) CH4: Hi-Z input supported
Output Channels	SPEAKERS (L, R): 1 MONITOR OUT(L, R): 1 SUBWOOFER OUT: 1
Bus	Stereo: 1, Effect: 1 HIGH: 8 kHz ±15 dB MID: 2.5 kHz ±15 dB LOW: 100 Hz ±15 dB
Input Channel Equalization	
Level Meter	6 points (-20, -6, 0, +3, +6, LIMITER)
Phantom Power Voltage	+30 V (CH1, 2)
Built-in Effect	SPX Algorithm 4 programs
REVERB FOOT SW	Effect Mute on/off
DSP Processing	FEEDBACK SUPPRESSOR, MASTER EQ
Protection	Load Protection; DC-fault Amplifier Protection: Over heat protection, Over current protection
Power Requirements	AC 100-240 V, 50 Hz/60 Hz
Power Consumption	35 W (Idle) / 90 W (1/8 Power)
Dimensions (W × H × D)	375 mm × 147 mm × 220 mm (14.8" × 5.8" × 8.7")
Net Weight	4.2 kg (9.3 lbs)
Optional Accessory	Foot Switch: FC5, Rack-Mount Kit: RK-EMX2, Mic Stand Adaptor: BMS-10A
Operating Temperature	0 to +40°C

For other specifications, see the included "Technical Specifications." The contents of this manual apply to the latest specifications as of the printing date. To obtain the latest manual, access the Yamaha website then download the manual file.

PRECAUTIONS

PLEASE READ CAREFULLY BEFORE PROCEEDING

Please keep this manual in a safe place for future reference.

WARNING

Always follow the basic precautions listed below to avoid the possibility of serious injury or even death from electrical shock, short-circuiting, damages, fire or other hazards. These precautions include, but are not limited to, the following:

Power supply/power cord

- Do not place the power cord near heat sources such as heaters or radiators, and do not excessively bend or otherwise damage the cord, place heavy objects on it, or place it in a position where anyone could walk on, trip over, or roll anything over it.
 - Only use the voltage specified as correct for the device. The required voltage is printed on the name plate of the device.
 - Use only the supplied power cord/plug.
 - If you intend to use the device in an area other than in the one you purchased, the included power cord may not be compatible. Please check with your Yamaha dealer.
 - Check the electric plug and each jack periodically, and remove any dirt or dust which may have accumulated. Failure to do so may cause electrical shock, short-circuiting or fire.
 - Is the [PHANTOM (CH1/2)] switch set to on when using a microphone that requires phantom power?
- The high sounds and low sounds are unbalanced.**
- Are the equalizer controls raised or lowered too much? Set the equalizer controls to the center position.
- When setting up the device, make sure that the AC outlet you are using is easily accessible. If some trouble or

- Do not use speakers for a long period of time at a high or uncomfortable volume level, since this can cause permanent hearing loss. If you experience any hearing loss or ringing in the ears, consult a physician.

- When turning on the AC power in your audio system, always turn on the device LAST, to avoid hearing loss and speaker damage. When turning the power off, the device should be turned off FIRST for the same reason.

Fire warning

- Do not place any burning items or open flames near the device, since they may cause a fire.

If you notice any abnormality

- If any of the following problems occur, immediately turn off the power switch and disconnect the electric plug from the outlet.
 - The power cord or plug becomes frayed or damaged.
 - Unusual smells or smoke are emitted.
 - Some object has been dropped into the device.
 - There is a sudden loss of sound during use of the device.
 - Cracks or other visible damage appear on the device.Then have the device inspected or repaired by qualified Yamaha service personnel.
- If this device should be dropped or damaged, immediately turn off the power switch, disconnect the electric plug from the outlet, and have the device inspected by qualified Yamaha service personnel.

CAUTION

Always follow the basic precautions listed below to avoid the possibility of physical injury to you or others, or damage to the device or other property. These precautions include, but are not limited to, the following:

Power supply/power cord

- When removing the electric plug from the device or an outlet, always hold the plug itself and not the cord. Pulling by the cord can damage it.

Location

- Do not place the device in an unstable position where it might accidentally fall over and cause injuries.
- Do not block the vents. This device has ventilation holes at the sides to prevent the internal temperature from becoming too high. In particular, do not place the device on its side or upside down. Inadequate ventilation can result in overheating, possibly causing damage to the device(s), or even fire.
- When using the device:
 - Do not cover it with any cloth.
 - Do not install it on a carpet or rug.

- Do not use the device in a confined, poorly-ventilated location.

Inadequate ventilation can result in overheating, possibly causing damage to the device(s), or even fire. If this device is to be used in a small space other than an EIA-standard rack, make sure that there is adequate space around the device: at least 30cm above, 30cm at the sides and 30cm behind.

- Do not place the device in a location where it may come into contact with corrosive gases or salt air. Doing so may result in malfunction.

- Before moving the device, remove all connected cables.

- If the device is mounted in an EIA standard rack, carefully read the section "Precautions for Rack Mounting" on page 2. Inadequate ventilation can result in overheating, possibly causing damage to the device(s), malfunction, or even fire.

Connections

- Do not use speaker cables with a metal-housing connector. Doing so may result in electrical shock due to differences in voltage. Use speaker cables with a nonmetal-housing connector, or with a insulated-housing connector.
- Before connecting the device to other devices, turn off the power for all devices. Also, before turning the power of all devices on or off, make sure that all volume levels are set to the minimum. Failing to do so may result in electric shock, hearing loss, or equipment damage.
- Use only speaker cables for connecting speakers to the speaker jacks. Use of other types of cables may result in fire.

Maintenance

- Remove the power plug from the AC outlet when cleaning the device.

Handling caution

- Avoid inserting or dropping foreign objects (paper, plastic, metal, etc.) into any gaps or openings on the device (vents, panel, etc.) If this happens, immediately turn off the power, unplug the power cord from the AC outlet, and have the device inspected by qualified Yamaha service personnel.
- Do not rest your weight on the device or place heavy objects on it, and avoid use excessive force on the buttons, switches or connectors to prevent injuries.

Yamaha cannot be held responsible for damage caused by improper use or modifications to the device.

(PA_en_6)

European Models

Purchaser/User Information specified in EN55103-2:2009. Conforms to Environments: E1, E2, E3 and E4

The model number, serial number, power requirements, etc., may be found on or near the name plate, which is at the bottom of the unit. You should note this serial number in the space provided below and retain this manual as a permanent record of your purchase to aid identification in the event of theft.

Model No.

Serial No.

(bottom_en_01)

FCC INFORMATION (U.S.A.)

- IMPORTANT NOTICE: DO NOT MODIFY THIS UNIT!** This product, when installed as indicated in the instructions contained in this manual, meets FCC requirements. Modifications not expressly approved by Yamaha may void your authority, granted by the FCC, to use the product.
- IMPORTANT:** When connecting this product to accessories and/or another product use only high quality shielded cables. Cable/s supplied with this product MUST be used. Follow all installation instructions. Failure to follow instructions could void your FCC authorization to use this product in the USA.
- NOTE:** This product has been tested and found to comply with the requirements listed in FCC Regulations, Part 15 for Class "B" digital devices. Compliance with these requirements provides a reasonable level of assurance that your use of this product in a residential environment will not result in harmful interference with other electronic devices. This equipment generates/uses radio frequencies and, if not installed and used according to the instructions found in the users manual, may cause interference harmful to the operation of other electronic devices. Compliance with FCC regulations does not guarantee that interference will not occur in all installations. If this product is found to be the source of interference, which can be determined by turning the unit "OFF" and "ON", please try to eliminate the problem by using one of the following measures:
 - Relocate either this product or the device that is being affected by the interference.
 - Utilize power outlets that are on different branch (circuit breaker or fuse) circuits or install AC line filter/s. In the case of radio or TV interference, relocate/reorient the antenna. If the antenna lead-in is 300 ohm ribbon lead, change the lead-in to co-axial type cable.
 - If these corrective measures do not produce satisfactory results, please contact the local retailer authorized to distribute this type of product. If you can not locate the appropriate retailer, please contact Yamaha Corporation of America, Electronic Service Division, 6600 Orangeflower Ave, Buena Park, CA90620The above statements apply ONLY to those products distributed by Yamaha Corporation of America or its subsidiaries.

* This applies only to products distributed by YAMAHA CORPORATION OF AMERICA.

(class B)

In Finland: Laite on liitettävä suojamaadoituskoskettimilla varustettuun pistorasiin.
In Norway: Apparatet må tilkoples jordat stikkontakt.
In Sweden: Apparatens skall anslutas till jordat uttag.

(class I hokuo)

For details of products, please contact your nearest Yamaha representative or the authorized distributor listed below.

NORTH AMERICA CANADA Yamaha Canada Music Ltd. 135 Milner Avenue, Toronto, Ontario, M1S 3R1, Canada Tel: +1-416-298-1311 U.S.A. Yamaha Corporation of America 6600 Orangeflower Avenue, Buena Park, CA 90620, U.S.A. Tel: +1-714-522-9011	NORTH AMERICA YAMAHA MUSIC LTD. Valletta Road, Mosta MF19010, Malta Tel: +356-2133-2093 NETHERLANDS/BELGIUM/ LUXEMBOURG Yamaha Music Europe Branch Benelux Clarissenhof 5b, 4133 AB Vianen, The Netherlands Tel: +31-347-358040 FRANCE Yamaha Music Europe 7 rue Ambroise Croizat, Zone d'activités de Pariest, 77183 Croissy-Beaubourg, France Tel: +33-1-6461-4000 ITALY Yamaha Music Europe GmbH, Branch Italy Viale Italia 88, 20020, Linate (Milano), Italy Tel: +39-02-93577-1 SPAIN/PORTUGAL Yamaha Music Europe GmbH Iberica, Sucursal en España Ctra. de la Corona km. 17,200, 28231 Las Rozas de Madrid, Spain Tel: +34-91-69-88-88 GREECE Philippou Nakas S.A. The Music House 19th Km. Leof. Lavriou 190 02 Peania - Attiki, Greece Tel: +30-210-6686168 SWEDEN/FINLAND/ICELAND Yamaha Music Europe GmbH Germany filial Scandinavia JA Wettergsgata 1, 421 30 Västra Frölunda, Sweden Tel: +46-31-89-34-00 DENMARK Yamaha Music Denmark Filial of Yamaha Music Europe GmbH, Tyskland Generatorvej 8C, ST. TH., 2860 Søborg, Denmark Tel: +45-44-92-49-00 NORWAY Yamaha Music Europe GmbH Germany - Norwegian Branch Grin Næringpark 1, 1361 Østerås, Norway Tel: +47-6716-7800 RUSSIA Yamaha Music (Russia) LLC Room 37, entrance 7, Bld. 7, Kievskaya street, Moscow, 121059, Russia Tel: +7-495-626-5005 OTHER EUROPEAN COUNTRIES Yamaha Music Europe GmbH Siemensstrasse 22-34, 25462 Rellingen, Germany Tel: +49-4101-3030 AFRICA Yamaha Music Gulf FZE JAFZA-16, Office 512, P.O. Box 17328, Jebel Ali FZE, Dubai, UAE Tel: +971-4-801-1500 MIDDLE EAST TURKEY Yamaha Music Europe GmbH Merkez Alinyası Türkiye İstambul Subesi Maslak Meydan Sokak No:5 Spring Güz Plaza Bağcısarı Böl. No:3, 34398 Şişli İstambul Tel: +90-212-999-8010 CYPRUS Yamaha Music Europe GmbH Siemensstrasse 22-34, 25462 Rellingen, Germany Tel: +49-4101-3030 OTHER COUNTRIES Yamaha Music Gulf FZE JAFZA-16, Office 512, P.O. Box 17328, Jebel Ali FZE, Dubai, UAE Tel: +971-4-801-1500	ASIA THE PEOPLE'S REPUBLIC OF CHINA Yamaha Music & Electronics (China) Co., Ltd. 2F, Yunhedasha, 1818 Xizha-lu, Jingtan-qu, Shanghai, China Tel: +86-400-051-7700 INDIA Yamaha Music India Private Limited Sparzee Building, Ground Floor, Tower A, Sector-47, Gurgaon, Sohna Road, Gurgaon-122002, Haryana, India Tel: +91-124-485-3300 INDONESIA PT. Yamaha Musik Indonesia (Distributor) Yamaha Music Center Bldg. Jalan Jend. Gatot Subroto Kav. 4, Jakarta 12930, Indonesia Tel: +62-21-520-2577 KOREA Yamaha Music Korea Ltd. 8F, Dongsung Bldg. 21, Tcheran-ro 87-gil, Gangnam-gu, Seoul, 135-880, Korea Tel: +82-2-3467-3300 MALAYSIA Yamaha Music (Malaysia) Sdn. Bhd. No. 8, Jalan Perbandaran, Kelana Jaya, 47301 Peatling Jaya, Selangor, Malaysia Tel: +60-3-78030900 SINGAPORE Yamaha Music (Asia) Private Limited Block 202 Hougang Street 21, #02-00, Singapore 330202, Singapore Tel: +65-6740-9200 TAIWAN Yamaha Music & Electronics Taiwan Co., Ltd. 2F, No. 1, Yuanfong Rd. Banqiao Dist. New Taipei City 22063, Taiwan Tel: +886-2-7741-8888 THAILAND Siam Music Yamaha Co., Ltd. 3, 4, 15, 16th Fl., Siam Motors Building, 891/1 Rama 1 Road, Wangmai, Pathumwan, Bangkok, 10330, Thailand Tel: +66-2215-2622 VIETNAM Yamaha Music Vietnam Corporation Limited 15th Floor, Nam A Bank Tower, 201-203 Cach Mang Thang Tam St., Ward 4, Dist. 3, Ho Chi Minh City, Vietnam Tel: +84-8-3818-1122 OTHER ASIAN COUNTRIES Yamaha Corporation Sales & Marketing Division 10-1, Nakazawa-cho, Naka-ku, Hamamatsu, Japan 430-8650 Tel: +81-53-460-2312 OCEANIA AUSTRALIA Yamaha Music Australia Pty. Ltd. Level 1, 99 Queensland Street, Southbank, Vic. 3006, Australia Tel: +61-3-9093-1100 COUNTRIES AND TRUST TERRITORIES IN PACIFIC OCEAN Yamaha Corporation Sales & Marketing Division 10-1, Nakazawa-cho, Naka-ku, Hamamatsu, Japan 430-8650 Tel: +81-53-460-2312
--	--	---

PA40

HEAD OFFICE Yamaha Corporation, Audio Products Sales and Marketing Division
10-1, Nakazawa-cho, Naka-ku, Hamamatsu, Japan 430-8650

Yamaha Pro Audio global website:
<http://www.yamahaproaudio.com/>

Yamaha Downloads
<http://download.yamaha.com/>

Manual Development Department

©2015 Yamaha Corporation

Published 07/2015 MWH-D-AO

Printed in China