

KAWAI

STAGE PIANO **MP11**

Owner's Manual v1.06

Introduction

Main Operation

EDIT Menu

STORE Button & SETUPS

Recorder

USB Menu

SYSTEM Menu

Appendix

Thank you for purchasing this Kawai MP11 stage piano.

This owner's manual contains important information regarding the instrument's usage and operation.

Please read all chapters carefully, keeping this manual handy for future reference.

■ About this Owner's Manual

Before attempting to play this instrument, please read the **Introduction** chapter from page 10 of this owner's manual. This chapter provides a brief explanation of each section of the MP11's control panel, an overview of its various jacks and connectors, and details how the components of the instrument's sound are structured.

The **Main Operation** chapter (page 20) provides an overview of the instrument's most commonly used functions, beginning with turning sections on and off, adjusting their volume, and selecting sounds. Later on, this chapter introduces basic sound adjustment using the four control knobs, before examining how EFX, reverb, amp simulation, and EQ can all be applied to dramatically change the character of the selected sound. The chapter closes with an explanation of the instrument's MIDI OUT section.

The **EDIT Menu** chapter (page 38) lists all available PIANO, E.PIANO, SUB, and MIDI OUT section parameters by category for convenient reference. The **STORE Button & SETUP Menus** chapter (page 59) outlines storing customised sounds, capturing the entire panel configuration as a SETUP, then recalling different SETUPS from the MP11's internal memory.

The **Recorder** chapter (page 63) provides instructions on how to record and play back pieces stored both in the instrument's internal memory, and also MP3/WAV audio files saved to USB memory devices. This chapter also explains the MP11's metronome/drum pattern functions. Additional USB functions are covered in greater detail in the **USB Menu** chapter (page 92), while the **SYSTEM Menu** chapter (page 98) explains the MP11's System Settings and various reset functions.

Finally, the **Appendix** section (page 110) includes USB-MIDI driver information, software update instructions and listings of the instrument's internal sounds and drum rhythms, effects, MIDI reference information, and full specification details.

Important Safety Instructions

SAVE THESE INSTRUCTIONS

INSTRUCTIONS PERTAINING TO A RISK OF FIRE, ELECTRIC SHOCK, OR INJURY TO PERSONS



WARNING

TO REDUCE THE RISK OF FIRE OR ELECTRIC SHOCK, DO NOT EXPOSE THIS PRODUCT TO RAIN OR MOISTURE.

AVIS : RISQUE DE CHOC ELECTRIQUE - NE PAS OUVRIR.

TO REDUCE THE RISK OF ELECTRIC SHOCK, DO NOT REMOVE COVER (OR BACK). NO USER-SERVICEABLE PARTS INSIDE. REFER SERVICING TO QUALIFIED SERVICE PERSONNEL.



The lightning flash with arrowhead symbol, within an equilateral triangle, is intended to alert the user to the presence of uninsulated "dangerous voltage" within the product's enclosure that may be of sufficient magnitude to constitute a risk of electric shock to persons.



The exclamation point within an equilateral triangle is intended to alert the user to the presence of important operating and maintenance (servicing) instructions in the literature accompanying the product.

Examples of Picture Symbols



denotes that care should be taken. The example instructs the user to take care not to allow fingers to be trapped.



denotes a prohibited operation. The example instructs that disassembly of the product is prohibited.



denotes an operation that should be carried out. The example instructs the user to remove the power cord plug from the AC outlet.

Read all the instructions before using the product.

- 1) Read these instructions.
- 2) Keep these instructions.
- 3) Heed all warnings.
- 4) Follow all instructions.
- 5) Do not use this apparatus near water.
- 6) Clean only with dry cloth.
- 7) Do not block any ventilation openings. Install in accordance with the manufacturer's instructions.
- 8) Do not install near any heat sources such as radiators, heat registers, stoves, or other apparatus (including amplifiers) that produce heat.
- 9) Do not defeat the safety purpose of the polarized or grounding-type plug. A polarized plug has two blades with one wider than the other. A grounding type plug has two blades and a third grounding prong. The wide blade or the third prongs are provided for your safety. If the provided plug does not fit into your outlet, consult an electrician for replacement of the obsolete outlet.
- 10) Protect the power cord from being walked on or pinched particularly at plugs, convenience receptacles, and the point where they exit from the apparatus.
- 11) Only use attachments/accessories specified by the manufacturer.
- 12) Use only with the cart, stand, tripod, bracket, or table specified by the manufacturer, or sold with the apparatus. When a cart is used, use caution when moving the cart/apparatus combination to avoid injury from tip-over. 
- 13) Unplug this apparatus during lightning storms or when unused for long periods of time.
- 14) Refer all servicing to qualified service personnel. Servicing is required when the apparatus has been damaged in any way, such as power-supply cord or plug is damaged, liquid has been spilled or objects have fallen into the apparatus, the apparatus has been exposed to rain or moisture, does not operate normally, or has been dropped.

When using electrical products, the following basic precautions should always be followed:



WARNING

Indicates a potential hazard that could result in death or serious injury if the product is handled incorrectly.

The product should be connected to an AC outlet of the specified voltage.



- If you are going to use an AC power cord, make sure that its has the correct plug shape and conforms to the specified power voltage.
- Failure to do so may result in fire.

Do not insert or disconnect the power cord plug with wet hands.



Doing so may cause electric shock.

Take care not to allow any foreign matter to enter the product.

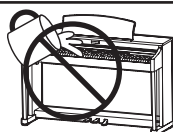

Entry of water, needles or hair pins may result in breakdown or short-circuit. The product shall not be exposed to dripping or splashing. No objects filled with liquids, such as vases, shall be placed on the product.

When using the headphones, do not listen for long periods of time at high volume levels.

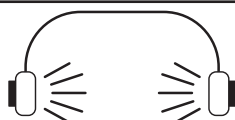

Doing so may result in hearing problems.

Do not disassemble, repair or modify the product.

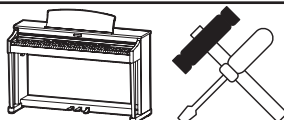

Doing so may result in product breakdown, electric shock or short-circuit.

When disconnecting the AC power cord's plug, always hold the plug and pull it to remove it.



- Pulling the AC power cord itself may damage the cord, causing a fire, electric shock or short-circuit.

The product is not completely disconnected from the power supply even when the power switch is turned off. If the product will not be used for a long time, unplug the AC power cord from the AC outlet.



- Failure to do so may cause fire in case of lightning.
- Failure to do so may over-heat the product, resulting in fire.

It is good practice to place the instrument near the AC outlet and the power cord plug in a position so that it can readily be disconnected in an emergency because electricity is always charging while the plug is in the AC outlet even in a power switch off condition.

Ensure that this product is connected to a socket with a protective earth connection.

GROUNDING INSTRUCTIONS

This product must be grounded. If it should malfunction or breakdown, grounding provides a path of least resistance for electric current to reduce the risk of electric shock. This product is equipped with a cord having an equipment-grounding conductor and a grounding plug. The plug must be plugged into an appropriate outlet that is properly installed and grounded in accordance with all local codes and ordinances.

DANGER - Improper connection of the equipment-grounding conductor can result in a risk of electric shock. Check with a qualified electrician or serviceman if you are in doubt as to whether the product is properly grounded. Do not modify the plug provided with the product - if it will not fit the outlet, have a proper outlet installed by a qualified electrician.



CAUTION

Indicates a potential hazard that could result in injury or damage to the product or other property if the product is handled incorrectly.

Do not use the product in the following areas.

- Areas, such as those near windows, where the product is exposed to direct sunlight
- Extremely hot areas, such as near a heater
- Extremely cold areas, such as outside
- Extremely humid areas
- Areas where a large amount of sand or dust is present
- Areas where the product is exposed to excessive vibrations

Using the product in such areas may result in product breakdown. Use the product only in moderate climates (not in tropical climates).

Before connecting cords, make sure that the power to this product and other devices is turned OFF.

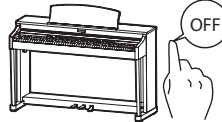

Failure to do so may cause breakdown of this product and other devices.

Do not drag the product on the floor. Take care not to drop the product.

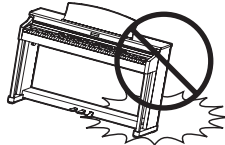

Please lift up the product when moving it. Please note that the product is heavy and must be carried by more than two persons. Dropping the product may result in breakdown.

Do not place the product near electrical appliances such as TVs and radios.

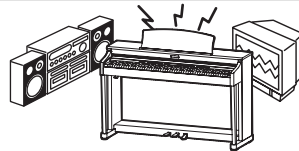

- Doing so may cause the product to generate noise.
- If the product generates noise, move the product sufficiently away from the electrical appliance or connect it to another AC outlet.

When connecting the AC power cord and other cords, take care not to get them tangled.



Failure to do so may damage them, resulting in fire, electric shock or short-circuit.

Do not wipe the product with benzene or thinner.



- Doing so may result in discoloration or deformation of the product.
- When cleaning the product, put a soft cloth in lukewarm water, squeeze it well, then wipe the product.

Do not stand on the product or exert excessive force.



- Doing so may cause the product to become deformed or fall over, resulting in breakdown or injury.

Do not place naked flame, such as lighted candles on the product.

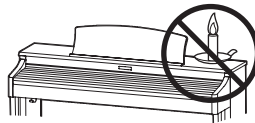

Doing so may cause the illumination to fall over, resulting in fire.

Ensure that the ventilation is not impeded by covering the ventilation openings with items, such as newspaper, table-cloths, curtains, etc.

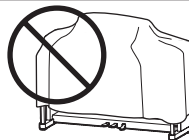

Failure to do so may over-heat the product, resulting in fire.

The product should be located so that its location or position does not interfere with its proper ventilation. Ensure a minimum distance of 5cm around the product for sufficient ventilation.

The product should be serviced by qualified service personnel when:

- The power supply cord or the plug has been damaged.
- Objects have fallen, or liquid has been spilled into the product.
- The product has been exposed to rain.
- The product does not appear to operate normally or exhibits a marked change in performance.
- The product has been dropped, or the enclosure damaged.

Notes on Repair

Should an abnormality occur in the product, immediately turn the power OFF, disconnect the power cord plug, and then contact the shop from which the product was purchased.

Instruction for AC power cord (U.K.)

WARNING: THIS APPARATUS MUST BE EARTHED

IMPORTANT: The wires in this mains lead are coloured in accordance with the following code:

- GREEN-AND-YELLOW: EARTH
- BLUE: NEUTRAL
- BROWN: LIVE

As the colours of the wires in the mains lead of this apparatus may not correspond with the coloured markings identifying the terminals in your plug, proceed as follows.

- The wire which is coloured GREEN-AND-YELLOW must be connected to the terminal in the plug which is marked by the letter E or by the safety earth symbol or coloured GREEN or GREEN-AND-YELLOW.
- The wire which is coloured BLUE must be connected to the terminal which is marked with the letter N or coloured BLACK.
- The wire which is coloured BROWN must be connected to the terminal which is marked with the letter L or coloured RED.

An information on Disposal for users



If your product is marked with this recycling symbol it means that, at the end of its life, you must dispose of it separately by taking it to an appropriate collection point. You should not mix it with general household waste. Disposing of this product correctly will prevent potential negative effects on the environment and human health which could otherwise arise due to inappropriate waste handling. For further details, please contact your local authority. (European Union only)

FCC Information (U.S.A)

CAUTION: Changes or modifications not expressly approved by the party responsible for compliance could void the user's authority to operate the equipment.

NOTE: This equipment has been tested and found to comply with the limits for a Class B digital device, pursuant to Part 15 of the FCC Rules. These limits are designed to provide reasonable protection against harmful interference in a residential installation. This equipment generates, uses and can radiate radio frequency energy and, if not installed and used in accordance with the instructions, may cause harmful interference to radio communications. However, there is no guarantee that interference will not occur in a particular installation. If this equipment does cause harmful interference to radio or television reception, which can be determined by turning the equipment off and on, the user is encouraged to try to correct the interference by one or more of the following measures:

- Reorient or relocate the receiving antenna.
- Increase the separation between the equipment and receiver.
- Connect the equipment into an outlet on a circuit different from that to which the receiver is connected.
- Consult the dealer or an experienced radio/TV technician for help.



Declaration of Conformity

Products:	Electronic Piano
Model Number:	MP11
Responsible Party Name:	Kawai America Corporation
Address:	2055 East University Drive, Rancho Dominguez, CA 90220
Telephone:	310-631-1771

This device complies with Part 15 of the FCC Rules. Operation is subject to the following two conditions:
(1) this device may not cause harmful interference, and
(2) this device must accept any interference received, including interference that may cause undesired operation.

This applies only to products distributed by Kawai America Corporation.

Table of Contents

Important Safety Instructions	4
Table of Contents	8

Introduction

Welcome to the MP11	10
1. Feature Highlights	10
2. Owner's Manual Conventions	11
Part Names & Functions	12
1. Front Panel: Knobs, Faders & Buttons	12
2. Front Panel: Jacks & Connectors	16
3. Rear Panel: Jacks & Connectors	16
Connecting to Other Devices	18
Understanding the MP11	19

Main Operation

Overview of Internal Sections	20
1. Section Basics	20
2. LCD Display & Control Knobs	21
3. Reverb	22
4. EFX	23
5. Amp Simulator (E.PIANO)	24
6. Key Range	26
Internal Sections & Feature Parameters	28
1. PIANO section	28
2. E.PIANO section	30
3. SUB section	31
Global Section	32
1. EQ	32
2. Transpose	34
MIDI OUT Section	36

EDIT Menu

Overview of the EDIT Menu (PIANO, E.PIANO, SUB)	38
EDIT Menu Parameters (PIANO, E.PIANO, SUB)	40
1. Reverb	40
2.1. EFX	40
2.2. Amp Simulator (E.PIANO)	41
3. Sound	42
4. Tuning	44
5. Key Setup	45
6. Controllers	47
7. Knob Assign	48
8. Virtual Technician (PIANO)	50
Virtual Technician (E.PIANO, SUB)	51
Overview of the EDIT Menu (MIDI OUT)	52
EDIT Menu Parameters (MIDI OUT)	54
1. Channel/Program	54
2. SETUP	54
3. Transmit	55
4. MMC	55
5. Key Setup	56
6. Controllers	57
7. Knob Assign	58

STORE Button & SETUPS

Overview of the STORE Button	59
1. Storing a SOUND	59
2. Storing a SETUP	60
3. Storing POWERON settings	61
SETUP memories	62

Recorder

Overview of the Recorder	63
Song Recorder (Internal memory)	64
1. Recording a song	64
2. Playing back a song	66
3. Saving a song as an SMF file	68
4. Loading an SMF file into memory	69
5. Erasing a song	72
6. Song Transpose	73
7. Panel Mode	73
8. MIDI to Audio	73
Audio Record/Playback (USB memory)	74
1. Recording an audio file	74
2. Playing an audio file	77
3. Overdubbing an audio file	80
4. Converting a recorder song to an audio file	83
Metronome	86
1. Click mode	86
2. Rhythm mode	87
3. Recording with the metronome	90

USB Menu

Overview of the USB Menu	92
USB Menu functions	93
1. Load	93
2. Save	94
3. Delete	95
4. Rename	96
5. Format	97

SYSTEM Menu

Overview of the SYSTEM Menu	98
SYSTEM Menu parameters & functions	99
1. Utility	99
2. Pedal	100
Expression pedal calibration	101
3. MIDI	102
4. Offset	103
5. User Edit	103
Creating a User Touch Curve	104
Creating a User Temperament	105
Creating a User Key Volume	106
Creating a User Stretch Tuning	107
6. Reset	108
Panel Lock (🔒)	109

Appendix

USB MIDI (USB to Host Connector)	110
Software Update	111
Sound List	112
Rhythm Pattern List	113
EFX Categories, Types, & Parameters	114
Specifications	119
MIDI Implementation	120
1. Recognised Data	121
2. Transmitted Data	125
3. Exclusive Data	127
4. SOUND/SETUP Program/Bank	133
5. Control Change Number (CC#) Table	134
6. MIDI Implementation Chart	135
User Notes	136

Welcome to the MP11

1 Feature Highlights

The best keyboard action available in a stage piano

The MP11 utilises Kawai's latest *Grand Feel* wooden-key keyboard action, which draws upon 85 years of acoustic piano craftsmanship to provide an exceptionally realistic playing experience.

As with a grand piano, all eighty-eight black and white keys are crafted from long pieces of wood, pivoting on a central balance pin in a smooth, seesaw-like motion. The *Grand Feel* keys are longer than any other digital piano keyboard action, with the pivot point distance extended to match that of a Kawai grand piano. When the front of a key is pressed down, the rear rises, throwing a hammer which plays the note. These hammers are graded in size and weight, replicating the heavier bass and lighter treble notes of an acoustic grand piano, while additional counter-weights embedded within the lower keys help to lighten their touch during pianissimo passages. The *Grand Feel* keyboard action even reproduces the subtle *let-off* sensation felt when playing the keys of a grand piano very softly, satisfying the expectations of even the most discerning pianists.

Finally, the *Grand Feel* keyboard action features Kawai's *Ivory Touch* key surfaces as standard. This finely textured material gently absorbs moisture to assist playing control, and possesses a natural, matte finish that is smooth, but not slippery.

PIANO section: The ultimate pianos for Concert, Pop, and Jazz

The MP11 captures the beautiful sound of Kawai's highly acclaimed hand-built concert grand piano, with all 88 keys of this exceptional instrument meticulously recorded, analysed and faithfully reproduced using proprietary *Harmonic Imaging™ XL* technology. This unique process accurately recreates the broad dynamic range of the original grand piano, affording pianists an extraordinary level of expressiveness ranging from the softest pianissimo to the strongest, boldest fortissimo.

With separate categories for Concert, Pop, and Jazz playing, the MP11 offers the finest selection of high quality acoustic piano sounds ever compiled for a Kawai instrument, with a separate category devoted entirely to upright and mono pianos.

Moreover, Kawai's unique *Virtual Technician* feature allows various characteristics of the selected acoustic piano sound to be shaped at the touch of a button or the turn of a knob, with parameters to adjust voicing and regulation, string and damper resonances, and subtle hammer, damper, and key release noises.

E.PIANO section: Vintage EPs, twin effects, and amp simulation

The MP11 features a selection of incredible vintage electric piano sounds, each with their own distinctive characteristics. Enjoy their natural, organic sound, or pass the signal through a wide variety of classic effects stomp boxes, before plugging into one of the five classic amp and speaker cabinets – complete with realistic microphone character and position modelling.

SUB section: High quality strings, pads, basses and more

The MP11's SUB section features high quality strings, pads, basses, and other useful sounds that are ideal for creating splits and custom zones, layering with acoustic or electric pianos, or for playing individually, at the front of the mix. Additional Bell, Air, and Voice layers bring greater depth to the sound, with flexible ADSR parameters and resonance/cut-off controls all adjustable directly from the panel's assignable control knobs.

MIDI OUT section: Four zone master keyboard controller

The MP11 features a new, improved MIDI OUT section with four independent zones for controlling external devices, or integrating into the studio as a master keyboard. Use the assignable panel knobs to send CC# to connected hardware, or the recorder transport buttons to control a DAW without touching a mouse or leaving the piano. The MP11 even includes LINE IN jacks and a dedicated panel fader to adjust the level of connected devices, such as that old expander module or semi-weighted synth that you just can't live without, or a laptop running software instruments.

Intuitive operation, large LCD, real-time assignable control knobs

The MP11's control panel is clearly arranged and easy to use, with related functions grouped together and placed where you'd expect to find them. A large LCD display and four assignable control knobs, allow several parameters to be adjusted directly in real-time, without getting lost in menus – concentrate on playing, rather than trying to remember which button does what.

208 Setup memories: enough for the busiest stage musician

The MP11 allows every single customised sound, knob position, fader level, and adjustable parameter to be stored in memory as a SETUP, and recalled at the touch of a button. With over 200 SETUP memories, the MP11 is ideal for busy stage musicians who like to plan several shows ahead, before going out on the road.

USB to Device functionality, with MP3/WAV/SMF file recording and playback

The MP11 is equipped with USB connectors that not only allow the instrument to be connected to a computer for MIDI use, but also to load and save data to USB memory devices directly. This 'USB to Device' feature allows customised sounds, SETUP memories, and recorder songs stored in internal memory to be saved to USB for posterity.

USB memory devices can also be used to play back MP3 or WAV audio or SMF MIDI files, allowing performing musicians to play along with professional backing tracks, or simply learn the chords or melody for a new piece. It is even possible to save performances directly as MP3, WAV, or SMF files for emailing to band members, casual listening away from the keyboard, or further editing using an audio workstation.

2 Owner's Manual Conventions

This owner's manual utilises a number of illustrative conventions in order to explain the MP11's various functions. The examples below provide an overview of the button LED indicator states and press types, and the appearance of different kinds of explanation text.

■ Button LED indicator states

ON / OFF



LED indicator OFF:

Sound/Function is not selected.

ON / OFF



LED indicator ON:

Sound/Function is selected.

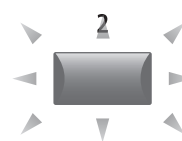

LED indicator flashing:

Sound/Function is selected in a temporary state.

■ Button press types

EQ



Normal press:

Select a sound or function, or turn a function ON/OFF.

EQ



Press and hold:

Show a function's parameters.

KEY RANGE

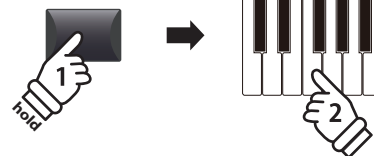

Press and hold, then press X:

Set split points, create zone ranges, set transpose key, etc.

■ Text appearance

Normal instruction and explanation text is written in regular type at 9 pt. size.

* Notes about functions are marked with an asterisk and written in 7.5 pt. size.

Reminders, hints, and additional explanations are written in italic type at 9 pt. size.

- Captions explaining the LCD display or button functions, are written in bold type at 8.5 pt. size.

Example operations are written in italic type at 8 pt. size, and enclosed within a grey box.

Part Names & Functions

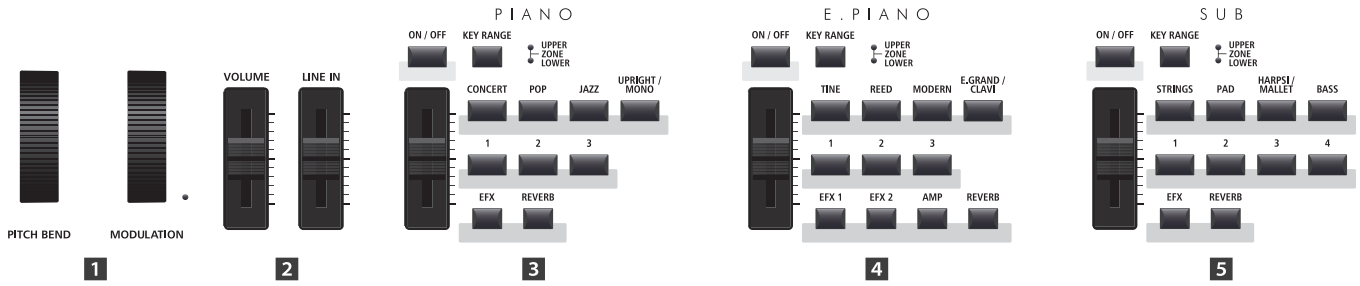

1 Front Panel: Knobs, Faders & Buttons

1 Control Wheels



PITCH BEND MODULATION

PITCH BEND wheel

This control wheel smoothly bends the pitch up or down from its current value.

MODULATION wheel

This control wheel controls the modulation (vibrato) depth. Moving the wheel forward increases the vibrato depth. The LED indicator will turn ON when this wheel is in use.

* Alternative functions can be assigned to the MODULATION wheel in the Controllers page of the EDIT menu (page 47).

2 Volume Faders

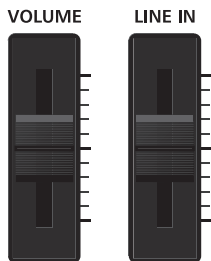

VOLUME LINE IN

VOLUME fader

This fader controls the master volume level of the MP11's NORMAL OUTPUT and HEADPHONE jacks.

* The fader does not affect the level of the FIXED OUTPUT jacks.

LINE IN fader

This fader controls the LINE IN volume level.

3 PIANO Section

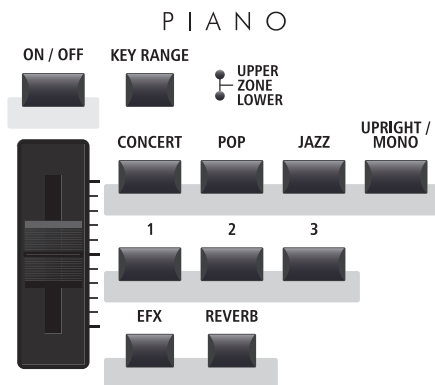

ON/OFF button

This button turns the PIANO section ON or OFF.

KEY RANGE button

This button selects the key range of the PIANO section.

UPPER/ZONE/LOWER LEDs

These LEDs indicate the key range to which the PIANO section is assigned.

VOLUME fader

This fader controls the volume level of the PIANO section.

CONCERT/POP/JAZZ/UPRIGHT-MONO buttons

These buttons select the category of the piano sound.

1/2/3 buttons

These buttons select the piano sound from each category.

EFX/REVERB buttons

These buttons turn the effects and reverb ON or OFF.

* Press and hold either button to show the respective settings pages of the EDIT menu in the LCD display.

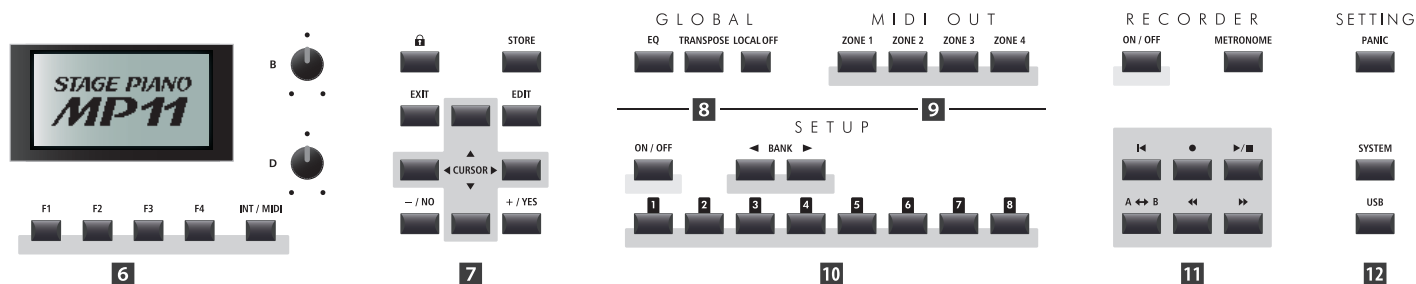

4 E.PIANO Section

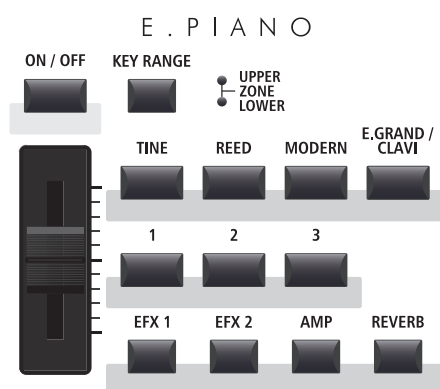

ON/OFF button

This button turns the E.PIANO section ON or OFF.

KEY RANGE button

This button selects the key range of the E.PIANO section.

UPPER/ZONE/LOWER LEDs

These LEDs indicate the key range to which the E.PIANO section is assigned.

VOLUME fader

This fader controls the volume level of the E.PIANO section.

TINE/REED/MODERN/E.GRAND-CLAVI buttons

These buttons select the category of the e.piano sound.

1/2/3 buttons

These buttons select the e.piano sound from each category.

EFX1/EFX2/AMP/REVERB buttons

These buttons turn the primary/secondary effects, amp simulator, and reverb ON or OFF.

* Press and hold either button to show the respective settings pages of the EDIT menu in the LCD display.

5 SUB Section

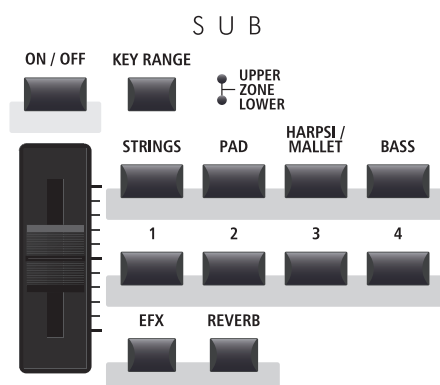

ON/OFF button

This button turns the SUB section ON or OFF.

KEY RANGE button

This button selects the key range of the SUB section.

UPPER/ZONE/LOWER LEDs

These LEDs indicate the key range to which the SUB section is assigned.

VOLUME fader

This fader controls the volume level of the SUB section.

STRINGS/PAD/HARPSI-MALLET/BASS buttons

These buttons select the category of the sub sound.

1/2/3/4 buttons

These buttons select the sub sound from each category.

EFX/REVERB buttons

These buttons turn the effects and reverb ON or OFF.

* Press and hold either button to show the respective settings pages of the EDIT menu in the LCD display.

6 DISPLAY Section



LCD Display

The LCD display provides a visual indication of the selected section and sound, parameter values, and the status of other functions when active.

A/B/C/D control knobs

These knobs adjust displayed parameter values in real-time.

* EDIT menu parameters can be freely assigned to each of the four knobs in the Knob Assign page of the EDIT menu (page 43).

F1/F2/F3/F4 buttons

These buttons select the three internal sound sections (PIANO, E.PIANO, SUB) to be displayed and controlled. In other modes (e.g. Recorder) these buttons also select additional functions.

INT/MIDI button

This button toggles between showing the internal sound sections (PIANO, E.PIANO, SUB), and the four MIDI OUT zones in the LCD display.

7 EDIT Section

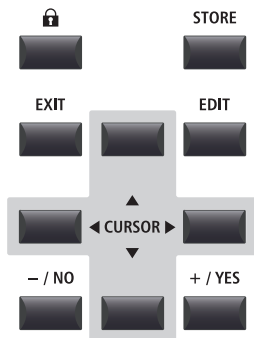

LOCK (🔒) button

This button locks the MP11's control panel, thus preventing any accidental button pushes during a performance.

STORE button

This button stores edited SOUNDS, or full panel settings to the SETUP and POWERON memories.

EXIT button

This button exits the current mode or page.

EDIT button

This button enters the EDIT menu. When the EDIT menu is displayed, this button also enters the selected parameter category page.

CURSOR buttons

These buttons move the selection cursor and scroll through the various pages of the EDIT menu.

- / NO + / YES buttons

These buttons decrease or increase the value of the selected parameter, and also cancel or confirm operations that require user interaction (e.g. Erasing data).

8 GLOBAL Section



EQ button

This button turns the global EQ ON or OFF. Press and hold the button to show the EQ settings screen in the LCD display.

TRANSPOSE button

This button turns the TRANSPOSE function ON or OFF. Press and hold the button to show the transpose settings pop-up in the LCD display.

LOCAL OFF

This button disables the internal connection between the MP11's keyboard and tone generators.

9 MIDI OUT Section



ZONE 1/ZONE 2/ZONE 3/ZONE 4 buttons

These buttons turn the four MIDI zones ON or OFF.

* Press and hold a button to show the respective MIDI zone's settings.

10 SETUP Section

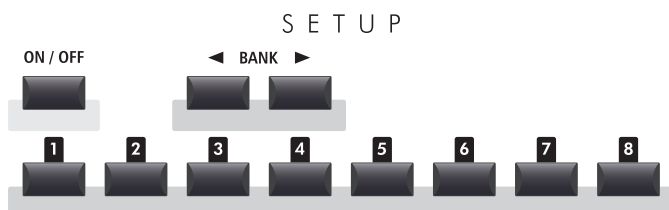

ON/OFF button

This button turns the SETUP section ON or OFF.

BANK buttons

These buttons select the SETUP bank from A to Z.

MEMORY buttons

These buttons select the SETUP memory from 1 to 8.

11 RECORDER Section

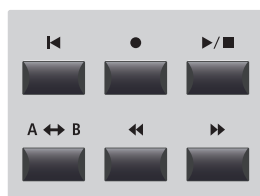

ON/OFF button

This button turns the RECORDER section ON or OFF.

METRONOME button

This button activates the METRONOME or RHYTHM patterns.

◀ (RESET) button

This button resets the MP11's song recorder, rewinding songs and MP3/WAV files to the beginning.

● (RECORD) and ▶/■ (PLAY/STOP) buttons

These buttons record and playback/stop songs stored in the MP11's internal memory, or MP3/WAV files saved to a USB memory device.

A ↔ B (LOOP) button

This button activates the MP11's A-B Loop function, allowing passages of a recorder song or MP3/WAV file to be played back repeatedly.

◀◀ (REW) and ▶▶ (FWD) buttons

These buttons are used to move the playing position of the current recorder song or MP3/WAV backward or forward.

12 SETTING Section

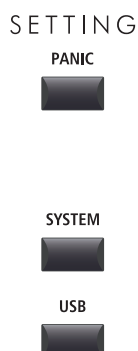

PANIC button

This button returns the MP11 to the Power On state, and also sends All Note Off and Reset All Controller messages via MIDI.

SYSTEM button

This button enters the SYSTEM menu, allowing many aspects of the MP11's functionality to be adjusted.

USB button

This button enters the USB menu, allowing data to be loaded and saved from/to a connected USB memory device.

2 Front Panel: Jacks & Connectors



HEADPHONE jack

The headphone jack is located at the left end of the key block and used to connect a pair of headphones equipped with a standard 1/4" phone jack.



USB TO DEVICE port

The USB to Device port is located at the right end of the key slip and used to connect a FAT or FAT32 formatted USB memory device to load and save data.

3 Rear Panel: Jacks & Connectors

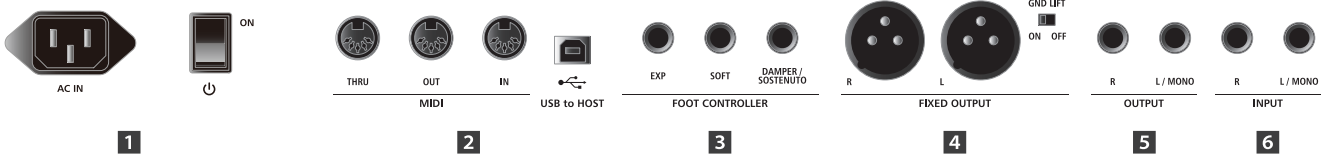

1 POWER Section



AC IN



ON

AC IN

Connect the power cable included with the MP11 to this receptacle.

POWER SWITCH

This switch turns the MP11 ON and OFF.

* The MP11 features a power saving mode that can turn off the instrument automatically after a specified period of inactivity. For more information, please refer to page 99.

2 MIDI Section

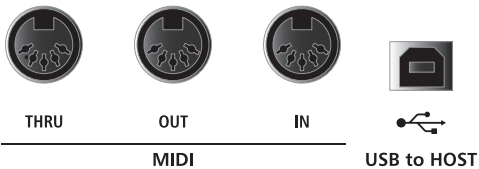

MIDI THRU/OUT/IN jacks

These jacks are used to connect the MP11 to external MIDI devices, and also to a computer with a MIDI interface as an alternative to the 'USB to Host' port.

USB TO HOST port

This port is used to connect the MP11 to a computer using a USB cable. When connected, the instrument can be used as a standard MIDI device, allowing it to send and receive MIDI data. Connect a 'B' type USB connector to the instrument, and an 'A' type USB connector to the computer.

* The instrument's USB MIDI port and MIDI IN/OUT jacks can be connected and used simultaneously. To adjust MIDI routing, please refer to the MIDI parameters in the SYSTEM menu, explained on page 102.

* When connecting the MP11 to a computer using the 'USB to Host' port, additional driver software may be required. For more information, please refer to page 110.

3 FOOT CONTROLLER Section

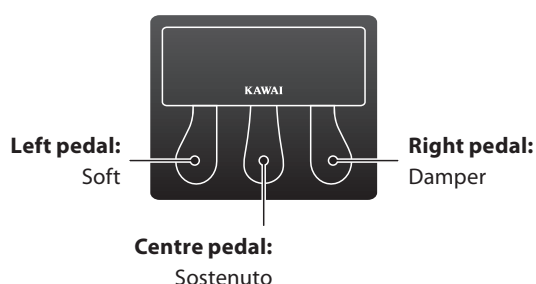
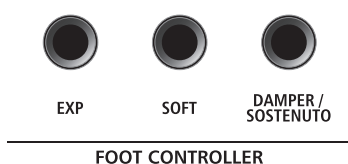

EXP jack

This jack is used to connect an expression pedal.

* For information about calibrating the expression pedal to ensure correct operation with the MP11, please refer to page 101.

SOFT jack

This jack is used to connect the soft pedal of the included F-30 triple pedal unit to the MP11. A separate momentary foot switch pedal can also be connected using this jack.

DAMPER/SOSTENUTO (F-30) jack

This jack is used to connect the damper and sostenuto pedals of the included F-30 triple pedal unit to the MP11.

By default, with the included F-30 triple pedal unit connected, the right pedal acts as a damper pedal, the centre pedal acts as a sostenuto pedal, and the left pedal functions as a soft pedal.

* Functions can be freely assigned to each foot controller in the Controllers page of the EDIT menu. For more information, please refer to page 57.

4 FIXED OUTPUT Section

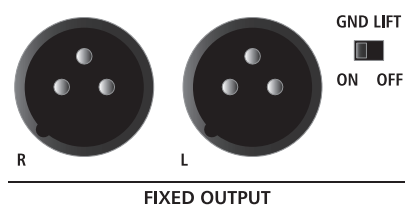

FIXED OUTPUT jacks

These jacks are used to connect the MP11 to a musical instrument amplifier, PA system, or recording console using XLR terminals. The VOLUME fader does NOT affect these outputs.

GND LIFT switch

This switch is used to shut the ground loop that can occur when connecting the MP11 using XLR terminals.

* This switch can typically be left in the OFF position.

5 OUTPUT Section

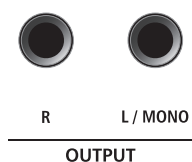

OUTPUT jacks

These jacks are used to connect the MP11 to a musical instrument amplifier, PA system, or recording console using standard 1/4" phone jacks. To output a mono signal, connect the cable to the L/MONO jack.

6 INPUT Section

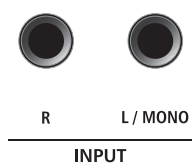

INPUT jacks

These jacks are used to connect a pair of stereo outputs from other electronic instruments or audio equipment to the MP11. The input level can be easily adjusted using the LINE IN fader. When connecting a mono audio source, connect the cable to the L/MONO jack only.

* When using the Audio Recorder function, the INPUT audio will also be recorded to the WAV/MP3 file. For more information, please refer to page 54.

Connecting to Other Devices

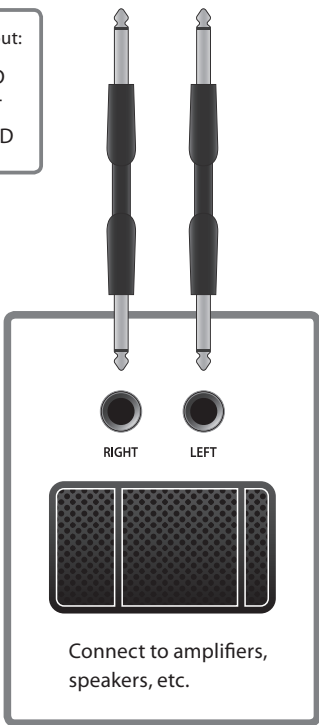
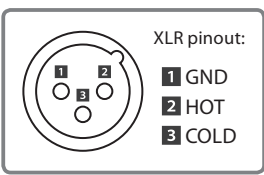
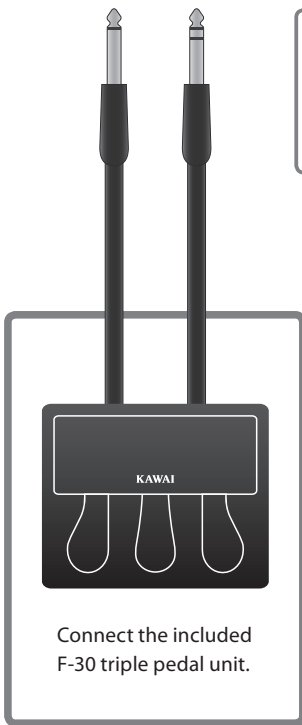
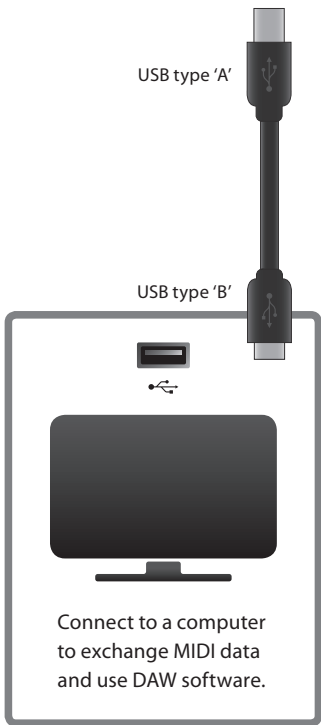
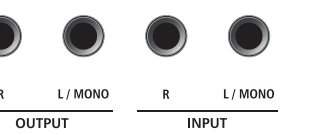
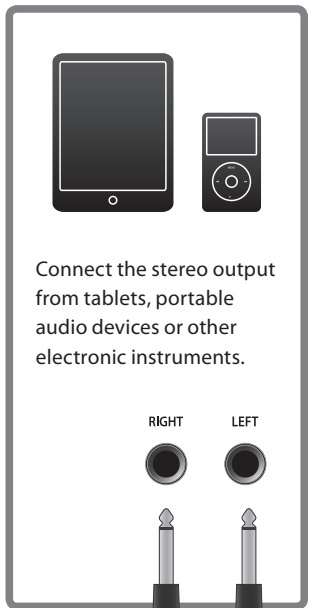
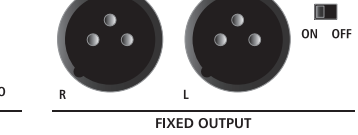
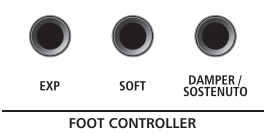
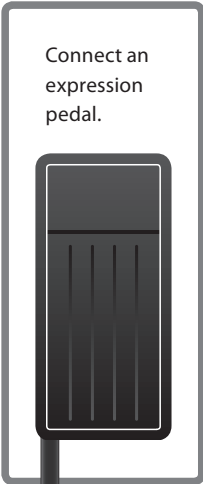
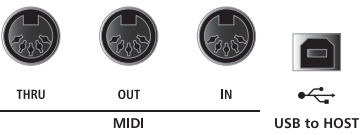
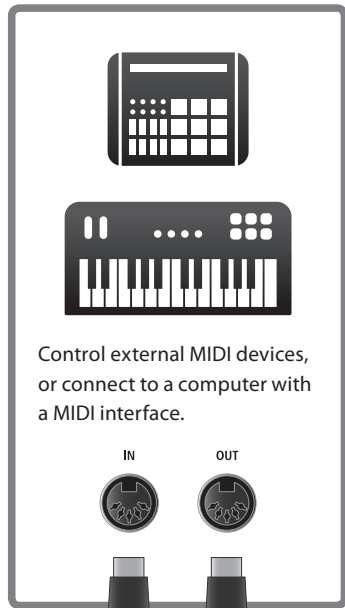

Understanding the MP11

■ Preparation before use

The MP11 does not feature built-in speakers. Therefore, in order to listen to the MP11, it will first be necessary to connect a mixer, keyboard amplifier, or headphones to the instrument.

Once connected to an audio output device, press the POWER SWITCH located on the right of the rear panel to turn on the MP11. It is recommended to turn on the MP11 before the audio output device in order to avoid the unpleasant switching noise that can sometimes occur.

■ MP11 section structure: explanation

The MP11 features 3 internal sound sections: PIANO, E.PIANO, and SUB. Each section features a dedicated VOLUME fader and can be turned ON or OFF freely.

The PIANO, E.PIANO, and SUB sections share largely the same operation, with 4 category buttons and multiple sounds assigned to each category. The PIANO and SUB sound sections each feature one EFX module, while the E.PIANO section offers two separate EFX modules and an additional AMP simulator. All sounds can be adjusted using the various parameters in the EDIT menu, with additional 'Feature Parameters' that are specific to each of the three sound sections.

The MP11's external (MIDI) functionality is divided into four independently controlled zones. As with the internal sound sections, various EDIT menu parameters are available to define transmit/receive channels, MMC features, keyboard ranges, and knob assignments etc.

REVERB settings are common for all internal sections, however the DEPTH can be controlled independently for each section. The MP11's EQ is also common for all internal sections, however parameters in the EDIT menu allow the tonal character for each section's sound to be adjusted independently.

Modifications to each sound can be stored as individual SOUND presets, while the entire configuration of the MP11 itself can be stored in one of the 208 SETUP memories.

As noted previously, the master VOLUME fader does not affect the FIXED OUTPUT jacks, but does affect the (normal) OUTPUT jacks. This allows audio engineers to control the level of the instrument at the mixing desk, while still allowing performers to adjust the volume of their monitor speakers freely.

■ MP11 section structure: block diagram

The diagram below illustrates the section structure of the MP11.

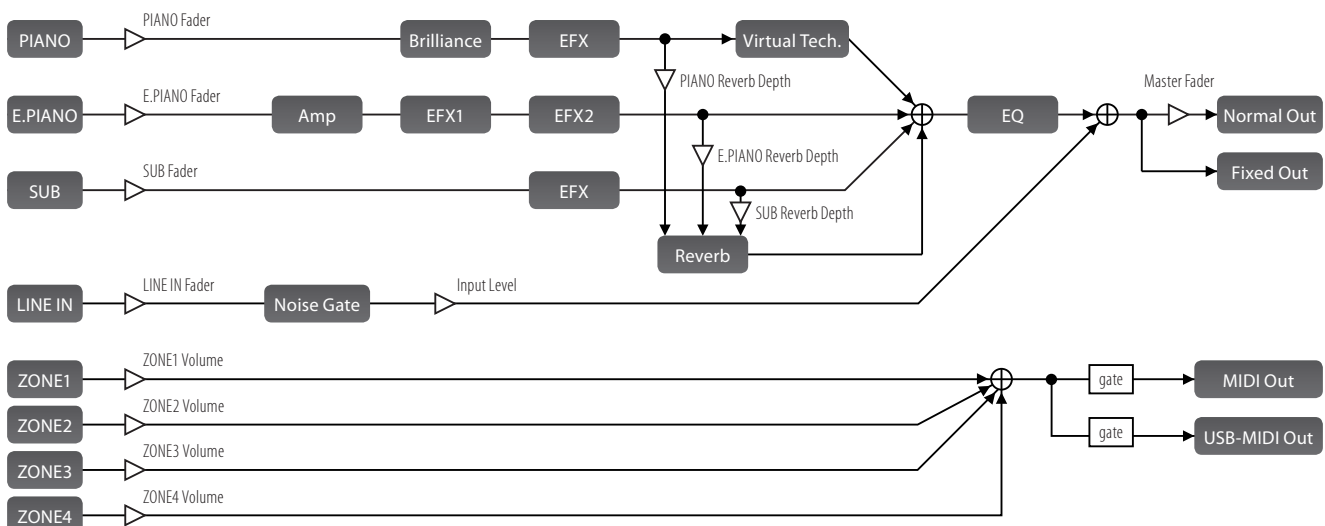

Overview of Internal Sections

1 Section Basics

As noted previously, the MP11's PIANO, E.PIANO, and SUB sections all share largely the same operation. This page will explain the fundamentals of turning sections ON and OFF, selecting sounds, and adjusting the section volume.

■ Turning a section ON or OFF

Press the ON/OFF button to turn each section ON or OFF.

The LED indicator for the ON/OFF button will turn ON or OFF to indicate the current status of the section.

If a section is turned OFF (but still shown in the LCD display), a * symbol will be added to the left of the sound name.



■ Selecting sounds

First, turn the PIANO section ON and all other sections OFF.

Press the one of the sound category buttons, then press one of the sound variation buttons.

The LED indicators for the selected sound category and variation buttons will turn on, and the variation list will pop-up briefly in the LCD display.

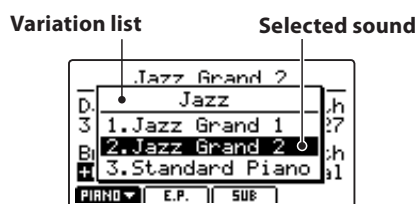

Experiment with selecting different categories and variations, playing the keyboard each time to hear the unique tonal characteristics of every sound.

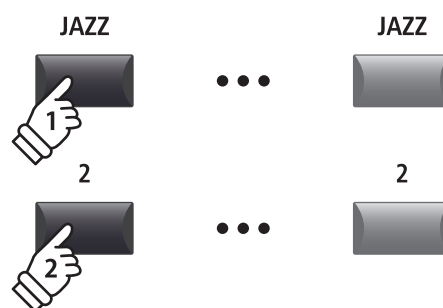

Example: To select the Jazz Grand 2 sound, press the JAZZ category button, then the 2nd variation button.

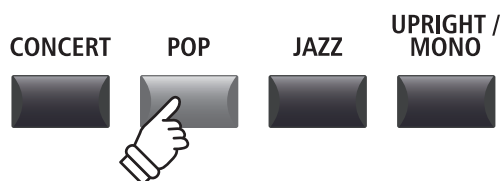

■ Adjusting the section volume

Use the VOLUME fader below each section's ON/OFF button to adjust the volume of the section.

The volume of the section will increase or decrease independently of the other sound sections.

* When playing with just a single section (e.g. PIANO), it is recommended to set the VOLUME fader to the maximum position.

To adjust the volume of all sound sections simultaneously, use the MASTER VOLUME fader (page 12).

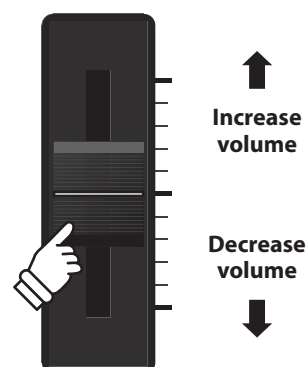

2 LCD Display & Control Knobs

In regular Play Mode the LCD display provides a visual indication of the selected section and sound, and the values of the four real-time control knobs (A, B, C, and D).

The function of each knob can be assigned to control any parameter in the EDIT menu, allowing frequently used functions to be accessed from a single screen. Furthermore, two groups of knob parameters (2 x 4) can be defined for each of the PIANO, E.PIANO, SUB sections and MIDI zones, providing extensive real-time control.

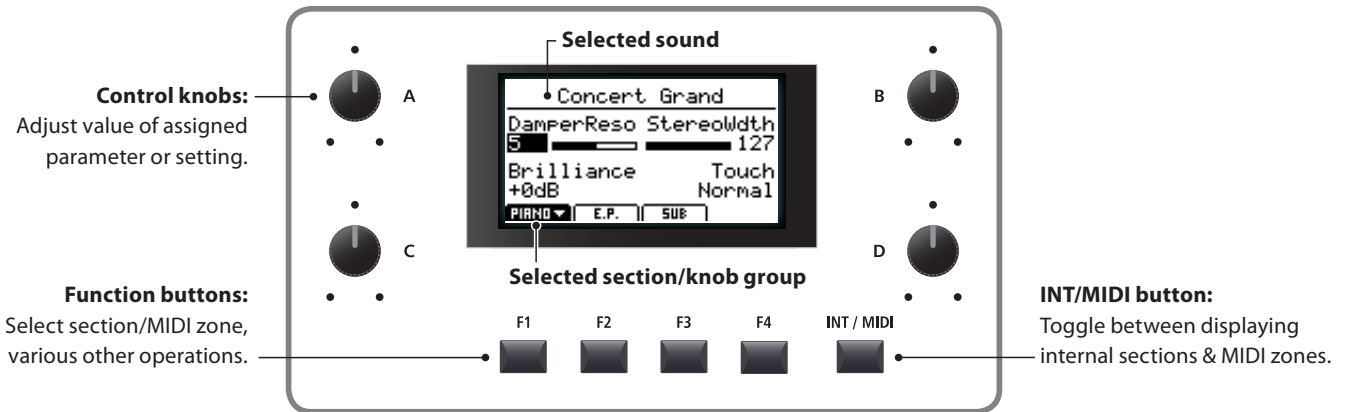

Selecting sections, primary/secondary knob groups

Press the function buttons located below the LCD display to select the desired internal section.

The section icon will become highlighted, and the name of the selected sound and primary group of knob parameters will be shown in the LCD display.

Press the same function button to cycle between the primary and secondary group of knob parameters in the LCD display.

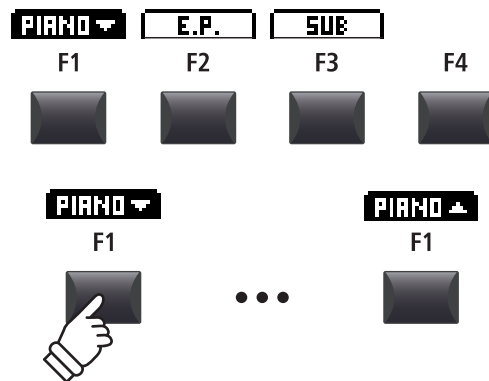

Toggling between internal sections and MIDI zones

Press the INT/MIDI button to toggle between showing the internal sections and MIDI zone volumes in the LCD display.

* For more information about MIDI zones, please refer to page 36.



Adjusting parameters

Turn the four control knobs (A, B, C, D) located on either side of the LCD display to adjust the displayed knob group parameters.

* EDIT menu parameters can be freely assigned to each of the four knobs in the Knob Assign page of the EDIT menu (page 48).

Parameters can also be adjusted by using the CURSOR buttons to move the selection cursor, and +/-/YES or -/NO buttons to increase or decrease the value of the selected parameter.

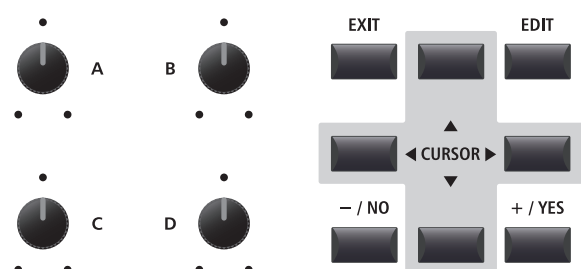

3 Reverb

Reverb adds reverberation to the sound, simulating the acoustic environment of a recital room, stage, or concert hall. The MP11 features 6 high quality types of reverb.

Each sound section features independent REVERB ON/OFF and REVERB DEPTH controls, however the REVERB TYPE (and associated settings) is common to all sections.

■ Reverb types

Reverb type	Description
Room	Simulates the ambience of a small rehearsal room.
Lounge	Simulates the ambience of a piano lounge.
Small Hall	Simulates the ambience of a small hall.
Concert Hall	Simulates the ambience of a concert hall or theater.
Live Hall	Simulates the ambience of a live hall or stage.
Cathedral	Simulates the ambience of a large cathedral.

■ Turning reverb ON or OFF

Press the desired sound section's REVERB button to turn the reverb for that section ON or OFF.

The LED indicator for the sound section's REVERB button will turn ON or OFF to indicate the current status of the reverb.



■ Changing the reverb type and additional parameters

Press and hold the section's REVERB button.

The REVERB page of the EDIT menu will be shown in the LCD display.



Turn the four control knobs (A, B, C, D) to change the reverb type and adjust additional reverb parameters.

Press and hold the REVERB button again to exit.

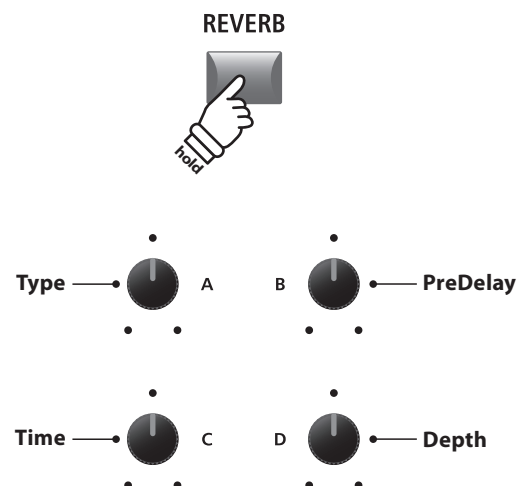

■ Reverb parameters

Knob	Parameter	Description	Value range
A	Type	Changes the type of environment.	(see table above)
B	PreDelay	Adjusts the delay time before the reverberation is applied.	0 ~ 200 ms
C	Time	Adjusts the decay length/speed of the reverberation.	300 ms ~ 10.0 s (depending on type)
D	Depth	Adjusts the depth of the environment (amount of reverberation).	0 ~ 127

4 EFX

In addition to reverb, various other effects can be applied to the selected sound, altering the tonal character and feeling of the instrument. The MP11 features 129 high quality EFX types, with an effect assigned to each sound by default.

The PIANO and SUB sound sections offer one effect module each, while the E.PIANO section features two separate effects modules that can be connected in series. For efficient selection, EFX types are sorted by category.

■ EFX categories

EFX category	Types	EFX category	Types	EFX category	Types	EFX category	Types
1 Chorus	8	7 Delay/Rev	8	13 Groove	4	19 Enhancer+	8
2 Flanger	5	8 PitchShift	3	14 Misc.	2	20 P.Shift+	6
3 Phaser	6	9 Compressor	2	15 Chorus+	6	21 Comp+	8
4 Wah	6	10 OverDrive	3	16 Phaser+	6	22 OverDrive+	8
5 Tremolo	6	11 EQ/Filter	5	17 Wah+	6	23 Parallel	6
6 AutoPan	4	12 Rotary	5	18 EQ+	8	TOTAL	129

* The '+' effects consist of the base effect plus an additional combination effect, while still using only one effect module.

* For more information about available effect categories, types, and parameters, please refer to page 114.

■ Turning effects ON or OFF

Press the desired sound section's EFX button to turn the effects for that section ON or OFF.

The LED indicator for the sound section's EFX button will turn ON or OFF to indicate the current status of the effects.

* The E.PIANO section's EFX1 and EFX2 modules are turned ON and OFF in exactly the same way.



■ Changing the effect category, type and additional parameters

Press and hold the section's EFX button.

The first EFX page of the EDIT menu will be shown in the LCD display.



Turn the control knobs (A, B, C, D) to change the effect category, type, and adjust additional effect parameters.

* The number of adjustable EFX parameters will vary depending on type.

* Press the F1, F2, and F3 buttons (corresponding to the selected section) and F4 button to scroll through the different EFX pages.

Press and hold the EFX button again to jump to the first EFX page of the EDIT menu, and once again to EXIT.

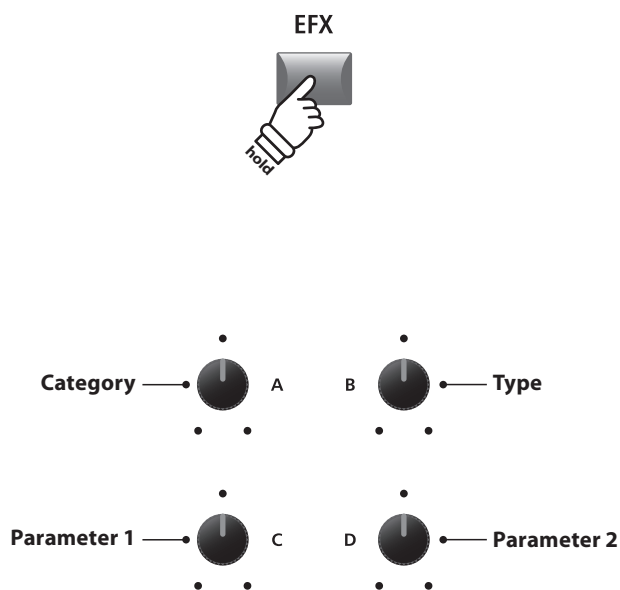

* Above knob assignments will change depending on EFX page displayed.

5 Amp Simulator (E.PIANO)

The tonal character of an amplifier or speaker cabinet is an important component of vintage electric piano sounds. The MP11's Amp Simulator function features 5 typical amplifier types and a selection of adjustable parameters.

Amp types

Amp type	Description
S. Case	A suitcase type amplifier, commonly used for vintage electric piano sounds.
M. Stack	A British valve guitar amplifier, known for its 'crunchy' tonal character.
J. Combo	A popular Japanese solid-state amplifier favoured for its clean, yet powerful sound.
F. Bass	An American valve bass amplifier that became popular for guitar, harmonica, and other instruments.
L. Cabi	A valve amplifier and speaker enclosed within a wooden cabinet, originally intended for drawbar organ sounds, but also used with electric pianos to produce a distinctive 'shimmering' sound.

Turning the Amp Simulator ON or OFF

Press the E.PIANO sound section's AMP button to turn the amp simulator ON or OFF.

The LED indicator for the AMP button will turn ON or OFF to indicate the current status of the amp simulator.

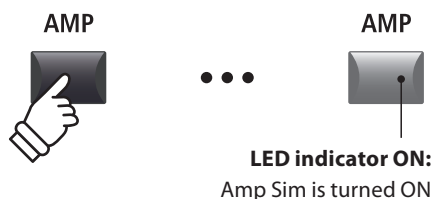

Changing the Amp type, adjusting drive, and level parameters

Press and hold the E.PIANO sound section's AMP button.

The first AMP page of the EDIT menu will be shown in the LCD display.

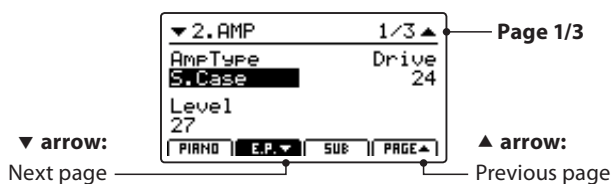

Turn the control knobs (A, B, C) to change the amp type, and adjust the drive, and level parameters.

* For more information about additional amp simulator parameters, please refer to page 25.

* Press the F2 and F4 buttons to scroll through the different AMP pages.

Press and hold the AMP button again to jump to the first AMP page of the EDIT menu, and once again to EXIT.

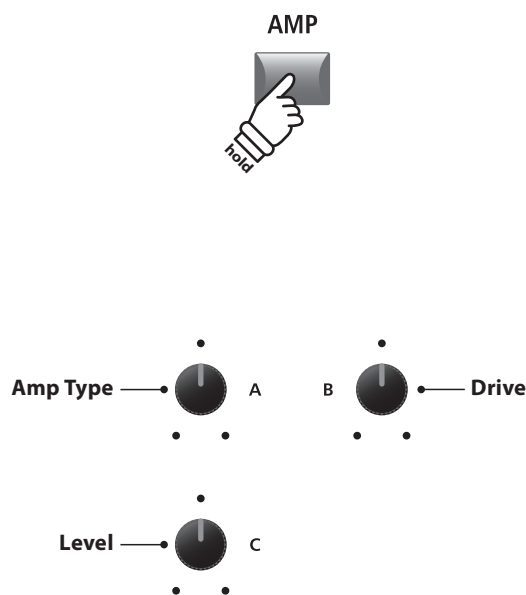

* Above knob assignments will change depending on AMP page displayed.

■ Amp Simulator parameters

Page	Knob	Parameter	Description	Value range
1	A	Amp Type	Changes the type of amplifier model.	[see table above]
	B	Drive	Adjusts the drive level of the amplifier.	0 ~ 127
	C	Level	Adjusts the overall volume level of the amplifier.	0 ~ 127
2	A	Amp EQ Lo	Adjusts the gain of the amplifier's low frequencies.	-10 dB ~ +10 dB
	B	Amp EQ Mid	Adjusts the gain of the amplifier's mid frequencies.	-10 dB ~ +10 dB
	C	Amp EQ Hi	Adjusts the gain of the amplifier's high frequencies.	-10 dB ~ +10 dB
	D	Mid Frequency	Adjusts the frequency of the amplifier's mid-range band.	200 Hz ~ 3150 Hz
3	A	Mic Type	Changes the type of microphone used for the amplifier.	Condenser, Dynamic
	B	Mic Position	Change the position of the microphone used for the amplifier.	OnAxis, OffAxis
	C	Ambience	Adjusts the mixing ratio of additional ambient microphones.	0 ~ 127

■ Adjusting additional Amp Simulator parameters

Press and hold the E.PIANO sound section's AMP button, then press the F2 button (corresponding to the selected E.PIANO section).

The second AMP page of the EDIT menu will be shown in the LCD display.

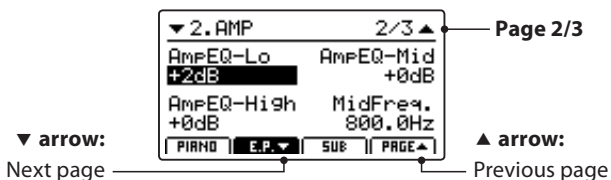

Turn the control knobs (A, B, C, D) to adjust the amp simulator's Lo, Mid, Hi, and MidFreq EQ parameters.

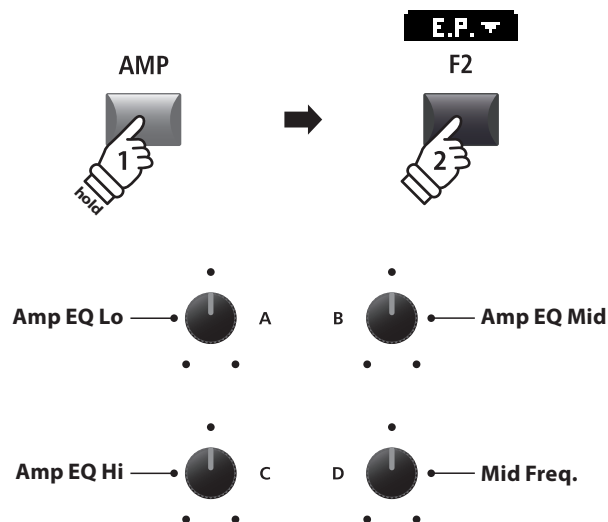

Press the F2 button again.

The third AMP page of the EDIT menu will be shown in the LCD display.



Turn the control knobs (A, B, C) to change the type and positioning of the amp simulator's microphone, and adjust the ambience parameter.

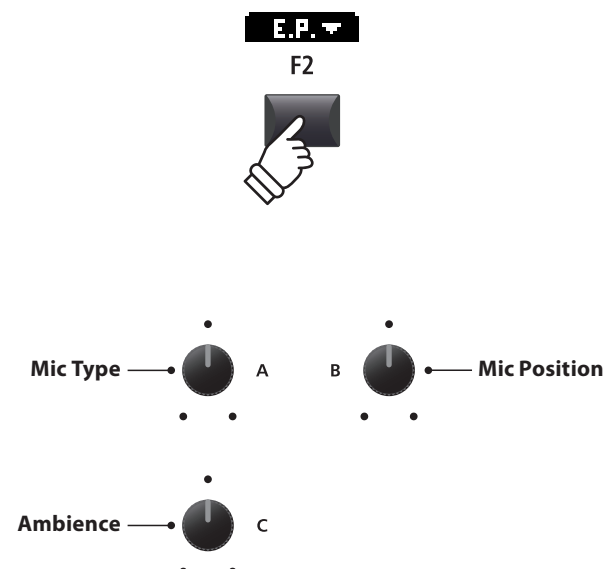

6 Key Range

The Key Range setting allows the key range of each sound section to be specified. By default, each internal section will utilise all 88 keys of the keyboard. However, it is also possible to easily create upper/lower splits or specify a zone between two defined keys.

Key Range types

Key Range type	Key Range LED	Description
Full Keyboard (default)	OFF	The selected sound section will be played with all 88 keys of the keyboard.
Lower	Lower ON	The keyboard is split into two parts, the lower part of the keyboard (from a defined split point to the bottom-most key) is used to play the selected section.
Upper	Upper ON	The keyboard is split into two parts, the upper part of the keyboard (from a defined split point to the top-most key) is used to play the selected section.
Zone	Upper + Lower ON	A zone between two defined keys is used to play the selected section.

Selecting Key Range types

Press the KEY RANGE button to cycle through the different key range types for the selection sound section.

The LED indicators will turn ON or OFF to indicate the selected Key Range type.

* The default Lower/Upper split point is set to F#2.

* The Lower/Upper split point is common for all internal sound sections and external MIDI zones. For more information about common parameters, please refer to page 38.

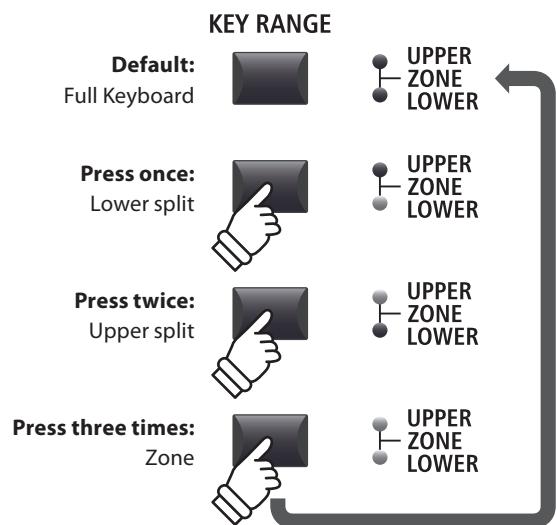

Checking the Lower/Upper split point

After selecting Lower/Upper key range type:

Press and hold the KEY RANGE button.

The current split point will pop-up in the LCD display.

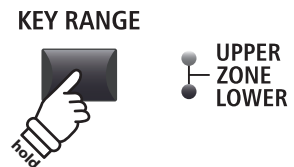

Common parameter:
See page 38



Current split point:
F#2

Release the KEY RANGE button

The split point pop-up will disappear.

■ Setting the Lower/Upper split point

After selecting the Lower/Upper key range type:

Press and hold the KEY RANGE button, then press the desired split key of the keyboard.

The name of the pressed key will be shown in the LCD display, and will become the new split point.

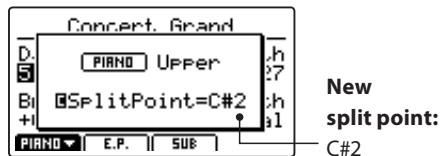

Release the KEY RANGE button.

The split point pop-up will disappear.

* The Lower/Upper split point is common for all internal sound sections and external MIDI zones. For more information about common parameters, please refer to page 38.

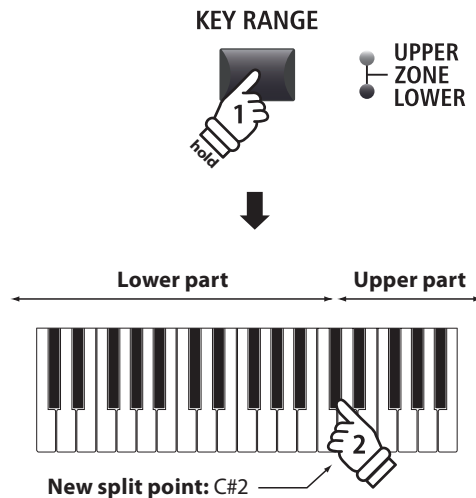

Example: To set the split point to key C#2, press and hold the KEY RANGE button, then press the C#2 key.

■ Setting the Zone key range

After selecting the Zone key range type:

Press and hold the KEY RANGE button, press the desired top key, and then the desired bottom key of the zone.

The names of the pressed top and bottom keys will be shown in the LCD display, and will become the new zone key range.

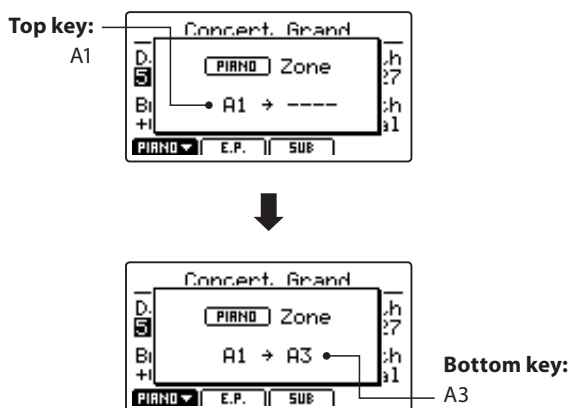

Release the KEY RANGE button.

The zone key range pop-up will disappear.

* Zone key ranges can be defined for each internal sound sections and external MIDI zone. For more information about key range parameters, please refer to page 45.

* It is also possible to check the Zone key range by pressing and holding the KEY RANGE button without setting the top and bottom keys.

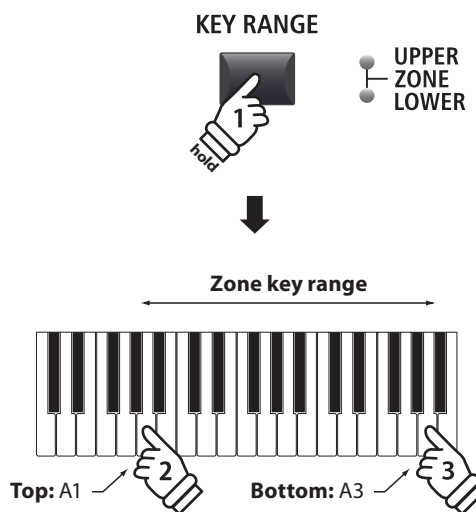

Example: To set the zone key range between key A1 and A3, press and hold the KEY RANGE button, press the A1 key, and then press the A3 key.

Internal Sections & Feature Parameters

1 PIANO section

The MP11's PIANO section features 12 different piano sounds arranged into CONCERT, POP, JAZZ, and UPRIGHT/MONO categories. All of the piano sounds have been sampled from Kawai instruments, using alternate voicing configurations, microphone positions, and recording techniques, in order to provide a selection of distinctive acoustic piano sounds that are suitable for various musical styles.

PIANO section sounds

Category	No.	Sound Name	Description
CONCERT	1	Concert Grand	A rich and dynamic concert grand piano.
	2	Studio Grand	A clear and powerful concert grand piano.
	3	Mellow Grand	A soft and warm concert grand piano.
POP	1	Pop Piano	A clear and vibrant pop grand piano.
	2	Bright Pop Piano	A sharp and bright pop grand piano.
	3	Mellow Pop Piano	A soft and warm pop grand piano.
JAZZ	1	Jazz Grand 1	A warm, powerful grand piano sound with a vintage jazz character.
	2	Jazz Grand 2	A brighter grand piano sound with a more modern jazz and fusion character.
	3	Standard Grand	The popular Concert Grand piano sound from the MP8II.
UPRIGHT / MONO	1	Upright Piano	A full-bodied traditional upright piano.
	2	Mono Pop Piano	A clear and vibrant pop grand piano, optimised for mono audio output.
	3	Mono Concert Piano	A rich and dynamic concert grand piano, optimised for mono audio output.

Feature Parameters: Virtual Technician

An experienced piano technician is essential to fully realise the potential of a fine acoustic piano. In addition to meticulously tuning each note, the technician also performs numerous regulation and voicing adjustments that allow the instrument to truly sing.

The PIANO section's Virtual Technician parameters simulate these refinements digitally, allowing performers to shape various aspects of the piano sound's character to suit their personal preferences.

Entering the Virtual Technician EDIT menu

After selecting the PIANO section (F1 button):

Press the EDIT button.

The PIANO section EDIT menu will be shown in the LCD display.

Edit Menu	
1. REVERB	5. KeySetup
2. EFX	6. Control
3. Sound	7. KnobAsgn
4. Tuning	8. VirtTech
PIANO	E.P. SUB

Press the CURSOR buttons to select 8.VirtTech, then press the +/YES button to enter the Virtual Technician parameter pages.

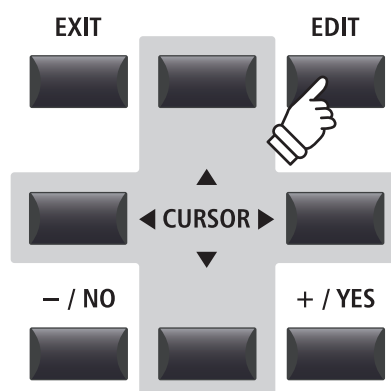

Virtual Technician parameters

Page	Knob	Parameter	Description	Value range
1	A	Voicing	Adjusts the tonal character of the selected piano sound.	[see below]
	B	Stereo Width	Adjusts the stereo width of the selected piano sound.	0 ~ 127
	C	String Resonance	Adjusts the resonance that is heard when notes are held.	OFF, 1 ~ 10
	D	Damper Resonance	Adjusts the resonance that is heard when pressing the damper pedal.	OFF, 1 ~ 10
2	A	Key-off Effect	Adjusts the sound that is heard when keys are released.	OFF, 1 ~ 10
	B	Damper Noise	Adjusts the sound that is heard when pressing the damper pedal.	OFF, 1 ~ 10
	C	Hammer Delay	Adjusts the delay of the hammer striking strings when playing pianissimo.	OFF, 1 ~ 10
	D	Fall-back Noise	Adjusts the sound that is heard when the key action falls back.	OFF, 1 ~ 10
3	A	Topboard	Adjusts the position of the grand piano topboard.	[see below]
	B	Brilliance	Adjusts the brightness of the overall piano sound.	-10 dB ~ +10 dB

* Voicing types: Normal, Mellow1, Mellow2, Dynamic, Bright1, Bright2

Topboard types: Close, Open1, Open2, Open3

* For more detailed information about the PIANO section's Virtual Technician parameters, please refer to page 50.

Adjusting Virtual Technician parameters

After entering the Virtual Technician parameters page:

Press the CURSOR buttons to move the selection cursor, and through the EDIT menu pages.

* The F1 and F4 buttons can also be used to scroll through the different EDIT menu pages.

Press the +/YES or -/NO buttons to increase or decrease values.

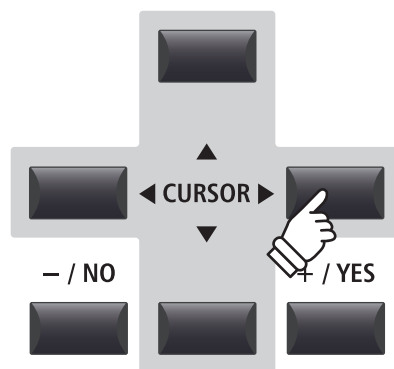
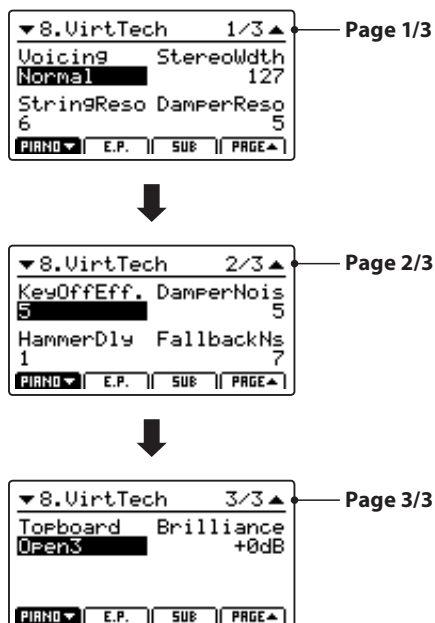

or

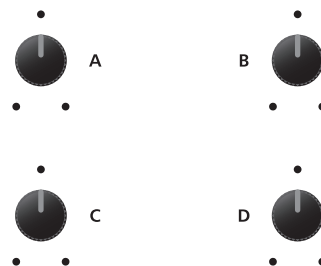

Alternatively, turn the control knobs (A, B, C, D) to adjust the parameter assigned to that knob.

Press the EXIT button to return to the main EDIT menu.



2 E.PIANO section

The MP11's E.PIANO section features 12 different electric piano sounds arranged into TINE, REED, MODERN, and E.GRAND/CLAVI categories. Each electric piano sound has been lovingly sampled from original, vintage instruments (complete with imperfections), and can be enjoyed in their 'organic' form, or with analogue effects and amp/speaker simulations applied for added warmth and character.

■ E.PIANO section sounds

Category	No.	Sound Name	Description
TINE	1	Tine EP 1	A suitcase-type vintage tine electric piano.
	2	Tine EP 2	A suitcase-type vintage tine electric piano modified for a brighter, harder sound.
	3	Tine EP 3	A stage-type vintage tine electric piano.
REED	1	Reed EP 1	A highly playable vintage reed electric piano.
	2	Reed EP 2	A bright vintage reed electric piano.
	3	Reed EP 3	A warm vintage reed electric piano.
MODERN	1	Modern EP 1	An FM type electric piano.
	2	Modern EP 2	An FM type electric piano with a fuller sound.
	3	Modern EP 3	An FM type electric piano with a mellow sound.
E.GRAND / CLAVI	1	Electric Grand	An electric grand piano with a strong attack.
	2	Clavi 1	A funky keyboard sound with electric pick-ups.
	3	Clavi 2	A fatter sounding Clavi sound.

■ Feature Parameters: Amp Simulator & Virtual Technician

As explained on page 24, the E.PIANO section features a dedicated Amp Simulator to recreate the tonal character of various amplifier/speaker cabinets. In addition, the E.PIANO section's Virtual Technician includes parameters to adjust key-off behaviour.

■ Amp Simulator parameters

Please refer to page 25 for a full list of amp simulator parameters.

■ Virtual Technician parameters

Page	Knob	Parameter	Description	Value range
1	A	Key-off Noise	Adjust the volume of the noise heard when the keys are released.	OFF, 1 ~ 127
	B	Key-off Delay	Adjusts the delay time before the Key-off Noise is heard.	0 ~ 127

* For more detailed information about the E.PIANO section's Virtual Technician parameters, please refer to page 51.

■ Adjusting Virtual Technician parameters

Please refer to page 28 for a full explanation of how to enter the Virtual Technician menu and adjust parameters.

3 SUB section

The MP11's SUB section features 16 additional 'subsidiary' sounds arranged into STRINGS, PAD, HARPSI/MALLET, and BASS categories. These sounds are suitable for layering with PIANO or E.PIANO section sounds, or for assigning to keyboard splits/zone, but can of course be played independently if desired.

■ SUB section sounds

Category	No.	Sound Name	Description
STRINGS	1	String Ensemble	A natural string sound with a lush, open character.
	2	Beautiful Str.	A mellow string sound with slow attack and fine treble.
	3	String Pad	A typical synth strings pad with a soft texture.
	4	Warm Strings	A warm string sound with a muted treble.
PAD	1	Pad 1	A typical synth pad.
	2	Pad 2	A fatter synth pad, with a slow release and attack characteristics.
	3	Pad 3	A warm synth pad with a vocal quality.
	4	Pad 4	A lush, airy synth pad with bell and vocal characteristics.
HARPSI / MALLETS	1	Harpsichord	A baroque period plucked instrument.
	2	Vibraphone	A percussive, tuned instrument played using mallets.
	3	Celesta	A metallic instrument with a soft timbre, played using a keyboard.
	4	Marimba	A percussive instrument with wooden bars, played using mallets.
BASS	1	Wood Bass	A large, low-pitched string instrument often used to accompany jazz.
	2	Finger Bass	A standard electric bass guitar with a clean tone.
	3	Fretless Bass	An electric bass guitar without frets.
	4	Wood Bass & Ride	A typical double bass combined with a ride cymbal.

■ Feature Parameters: Virtual Technician

When Harpsichord or Bass sounds are selected, the SUB section's Virtual Technician includes parameters to adjust key-off behaviour.

■ Virtual Technician parameters

Page	Knob	Parameter	Description	Value range
1	A	Key-off Noise	Adjust the volume of the noise heard when the keys are released.	OFF, 1 ~ 127
	B	Key-off Delay	Adjusts the delay time before the Key-off Noise is heard.	0 ~ 127

* The above parameters will only be available when a Harpsichord or Bass sound is selected.

* For more detailed information about the SUB section's Virtual Technician parameters, please refer to page 51.

■ Adjusting Virtual Technician parameters

Please refer to page 28 for a full explanation of how to enter the Virtual Technician menu and adjust parameter.

Global Section

1 EQ

The EQ function consists of a 4-band graphic equaliser that can be used to shape the overall tone of the MP11's internal sound sections. Two of the mid-range frequency bands can also be adjusted as a parametric equaliser.

The equaliser setting is common to all internal sound sections.

■ Turning EQ ON or OFF

Press the EQ button to turn the MP11's equaliser ON or OFF.

The LED indicator for the EQ button will turn ON or OFF to indicate the current status of the equaliser.

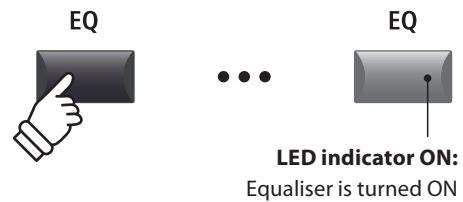

■ EQ parameters

Page	Knob	Parameter	Description	Value range
1	A	Low Gain	Adjusts the gain of the low range frequency band (20 ~ 100 Hz).	-10 dB ~ +10 dB
	B	High Gain	Adjusts the gain of the high range frequency band (5000 ~ 20000 Hz).	-10 dB ~ +10 dB
	C	Mid1 Gain	Adjusts the gain of the Mid1 frequency band (200 ~ 3150 Hz).	-10 dB ~ +10 dB
	D	Mid2 Gain	Adjusts the gain of the Mid2 frequency band (200 ~ 3150 Hz).	-10 dB ~ +10 dB
2	A	Mid1 Q	Adjusts the bandwidth of the Mid1 band.	0.5 ~ 4.0
	B	Mid2 Q	Adjusts the bandwidth of the Mid2 band.	0.5 ~ 4.0
	C	Mid1 Freq.	Adjusts the frequency of the Mid1 band.	200 Hz ~ 3150 Hz
	D	Mid2 Freq.	Adjusts the frequency of the Mid2 band.	200 Hz ~ 3150 Hz

■ Adjusting EQ parameters

Press and hold the EQ button.

The gain page of the EQ will be shown in the LCD display.

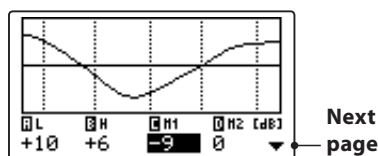

Press the CURSOR ◀▶ buttons to select the desired EQ parameter, then press the +/YES or -/NO buttons to increase or decrease the values.

Alternatively, turn the control knobs (A, B, C, D) to adjust the EQ parameter assigned to that knob.

* The F1~F4 buttons can also be used to select the desired EQ parameter. If the parameter is already selected, the F1~F4 buttons can be used to alternate between the gain and frequency pages of the EQ.

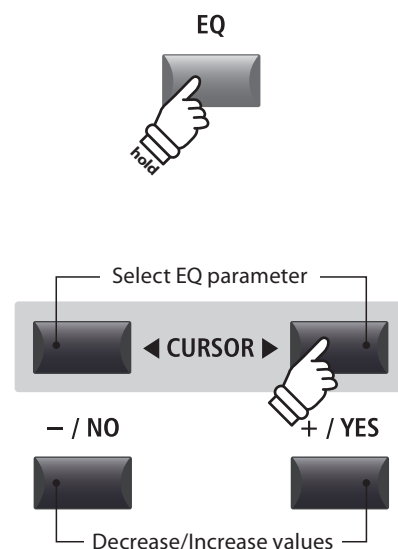

■ Adjusting EQ parameters (cont.)

While the gain page of the EQ is shown:

Press the CURSOR ▼ button.

The frequency page of the EQ will be shown in the LCD display.

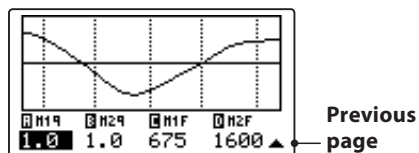

Press the CURSOR ◀▶ buttons to select the desired EQ parameter, then press the +/YES or -/NO buttons to increase or decrease the values.

Alternatively, turn the control knobs (A, B, C, D) to adjust the EQ parameter assigned to that knob.

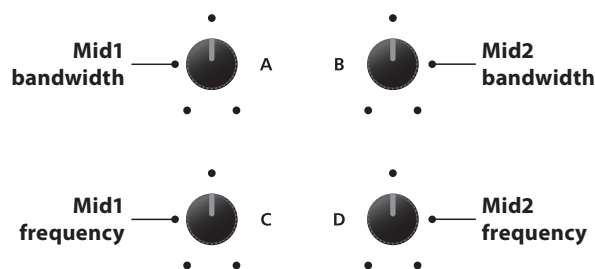

Press the EXIT button to return to the main playing screen.



■ Jump to EQ Offset shortcut

The EQ Offset is a SYSTEM parameter used to offset adjustments made by the EQ. The purpose of the EQ Offset is to allow a 'baseline' EQ to be applied independently of the EQ function, and therefore independently of the selected SETUP. EQ Offset must be enabled in the SYSTEM menu for this shortcut to function.

To jump to the EQ Offset screen, at any time:

Press and hold the EQ button, then press one of the F1~F4 buttons.

The EQ Offset screen will be shown in the LCD display.

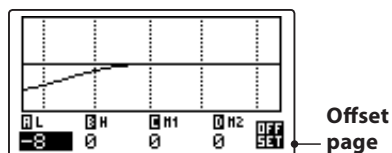

The EQ Offset parameters are adjustable in the same manner as the EQ gain parameters.

* The EQ Offset values will be added to the regular EQ values. The combined EQ values are limited to ± 10 dB.

Press the EXIT button to return to the EQ screen.

Press the EXIT button again to return to the main playing screen.

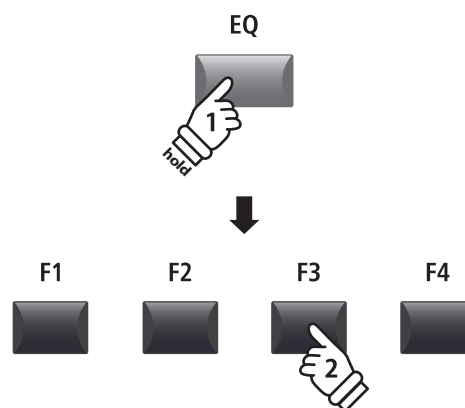

2 Transpose

The Transpose function allows the pitch of the MP11's keyboard to be raised or lowered in semi-tone steps. This is particularly useful when accompanying instruments tuned for different keys, or when a song learned in one key must be played in another key.

■ Turning Transpose ON or OFF

Press the TRANSPOSE button to turn the transpose function ON or OFF.

The LED indicator for the TRANSPOSE button will turn ON or OFF to indicate the current status of the transpose function.

* The previous transpose setting will be remembered after the transpose function is turned OFF, allowing rapid adjustment of the keyboard pitch.

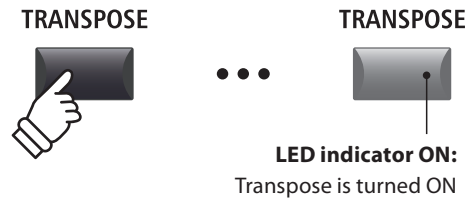

■ Checking the Transpose setting

Press and hold the TRANSPOSE button.

The current transpose setting will pop-up in the LCD display.

* The default value, 0, indicates no transposition.

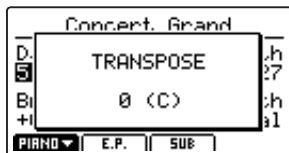
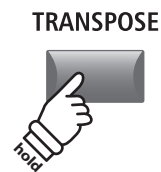

■ Setting the Transpose value: Method 1

Press and hold the TRANSPOSE button, then press the +/YES or -/NO buttons to increase or decrease the transpose value in semi-tone steps.

* The TRANSPOSE value can be adjusted within the range of -24 ~ +24.

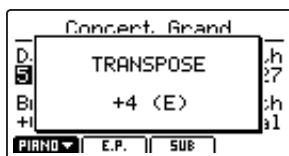

The LED indicator for the TRANSPOSE button will turn ON automatically to indicate that transpose is activated.

* To reset the transpose value to 0 (no transposition), press both the -/NO and +/YES buttons simultaneously.

* The transpose value will be stored to SYSTEM memory automatically, however the transpose ON/OFF state will not be stored.

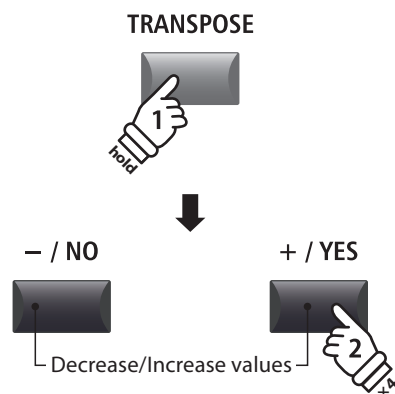

Example: To raise the keyboard pitch by 4 semi-tones, press and hold the TRANSPOSE button, then press the +/YES button four times.

■ Setting the Transpose value: Method 2

Press and hold the TRANSPOSE button, then press a key on the keyboard to the left or right of middle C.

The pressed key will become the new transpose key.

* The TRANSPOSE value can be adjusted within the range of -24 ~ +24.



The LED indicator for the TRANSPOSE button will turn ON automatically to indicate that transpose is activated.

* To reset the transpose value to 0 (no transposition), press both the -/NO and +/YES buttons simultaneously.

* The transpose value will be stored to SYSTEM memory automatically, however the transpose ON/OFF state will not be stored.

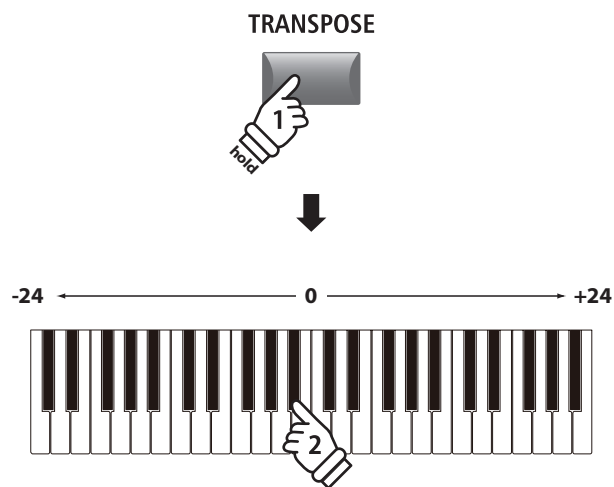

Example: To lower the keyboard pitch by 2 semi-tones, press and hold the TRANSPOSE button, then press the B^b key closest to the middle C key.

MIDI OUT Section

The MP11's MIDI OUT section features four independently adjustable zones than can be used to control external MIDI devices. MIDI channels can be assigned to each zone, then adjusted using the four real-time control knobs. By default, each zone will utilise all 88 keys of the keyboard, however as with the internal sound sections, it is possible to create upper/lower splits or specify a key range between two defined keys.

■ Turning a Zone ON or OFF

Press a ZONE button to turn each Zone ON or OFF.

The LED indicator for the pressed ZONE button will turn ON or OFF to indicate the current status of the Zone.

The active Zones and assigned MIDI channels will be shown in the LCD display.

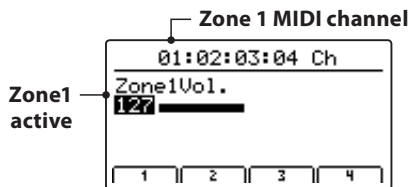

This is the MIDI zone volume screen, and will be shown automatically whenever a zone is turned ON or OFF.



Example: To turn on (activate) Zone1, press the ZONE1 button.

* By default Zone1~4 will be assigned MIDI channels 01, 02, 03, and 04 respectively. For information about changing the MIDI channel assigned to each zone, please refer to page 54.

■ Adjusting Zone volumes

When a Zone is turned on and the MIDI zone volume screen is shown:

Turn the control knobs (A, B, C, D) to adjust the volume of the zone assigned to that knob.

* Zone volumes can be adjusted within the range 0~127.

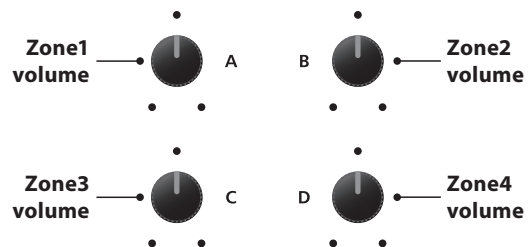
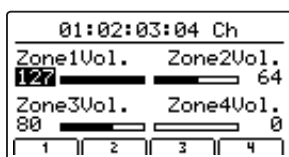

* It is also possible to adjust zone volumes by pressing the CURSOR buttons to select the desired zone, then pressing the -/NO or +/YES buttons to decrease or increase values.

■ Toggling between internal sections and MIDI zones

Press the INT/MIDI button to toggle between showing the internal sections and MIDI zone volumes in the LCD display.

INT / MIDI

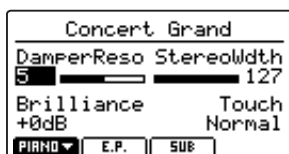
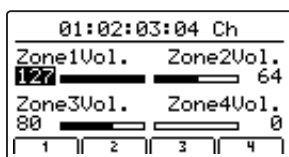

■ Adjusting Zone parameters (MIDI control change)

From the MIDI zone volume screen:

Press one of the F1~F4 buttons.

The first page of MIDI control change for the selected zone will be shown in the LCD display.

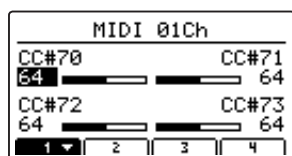

Turn the control knobs (A, B, C, D) to adjust the MIDI control change parameters assigned to that knob.

* For information about changing the MIDI control change parameters assigned to each control knob, please refer to page 58.

* When a zone is selected, pressing the F1~F4 button corresponding to that zone will toggle between the first and second pages of parameters.

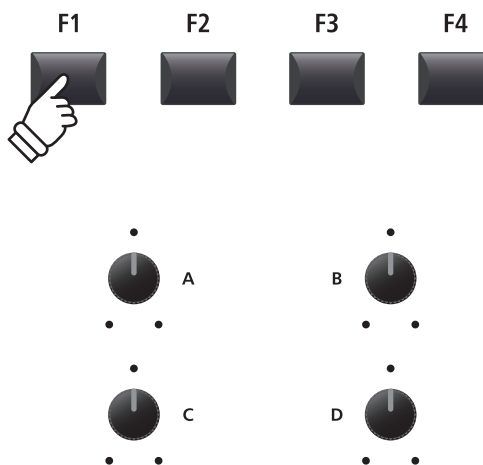

* It is also possible to adjust parameters by pressing the CURSOR buttons to select the desired parameter, then pressing the -/NO or +/YES buttons to decrease or increase values.

■ Adjusting the Zone key range

Press and hold a ZONE button, press the desired top key, and then the desired bottom key of the keyboard.

The names of the pressed top and bottom keys will be shown in the LCD display, and will become the new key range for the selected zone.

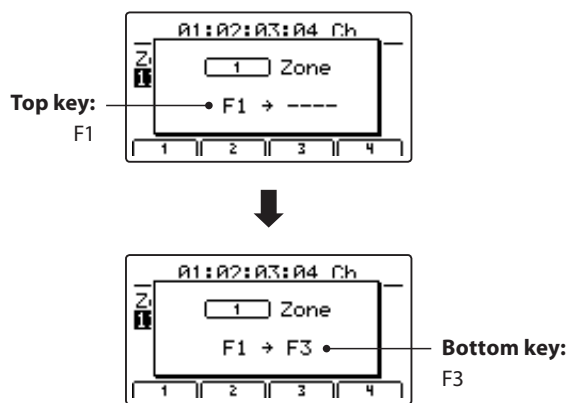

* To reset the key range back to all 88 keys (Full Keyboard), press and hold a zone button, then press the topmost and bottommost keys.

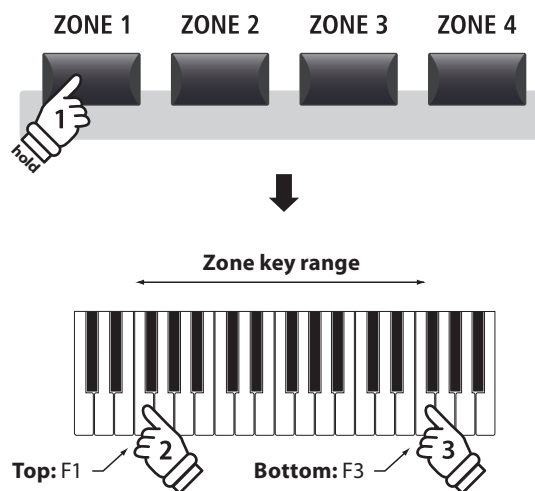

Example: To set the Zone1 key range between key F1 and F3, press and hold the ZONE1 button, press the F1 key, and then press the F3 key.

■ LOCAL OFF button

Press the LOCAL OFF button to disable the connection between the MP11's keyboard and internal tone generator.

The LED indicator for the LOCAL OFF button will turn ON or OFF to indicate the current status of the LOCAL OFF function.

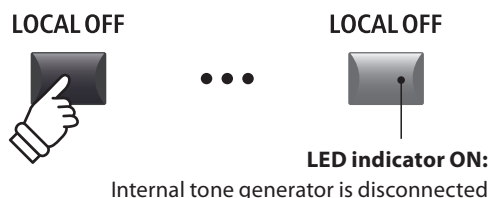

Overview of the EDIT Menu (PIANO, E.PIANO, SUB)

The EDIT menu contains various parameters that can be used to adjust the MP11's internal sound sections. The parameters are grouped by category, allowing close control over the instrument with just a few button presses.

* The EDIT menu can also be used to adjust parameters of the MIDI OUT section. For more information, please refer to page 54.

This collection of parameters, together with other adjustable settings, can be stored as a SETUP memory (page 60). The MP11 provides 26 banks x 8 setups, for a total of 208 user programmable SETUP memories.

About Common parameters (🔑 icon)

Unless stated, parameter settings for the PIANO, E.PIANO, and SUB sound sections are independent for each section. However, parameters marked with a 🔑 icon are common for all three sound sections. For example, changing the 🔑Reverb Type parameter for the PIANO section will automatically change the 🔑Reverb Type parameter for the E.PIANO, and SUB sections. Moreover, the 🔑Split Point parameter is unique in that it is common for all three sound sections and four MIDI zones.

PIANO/E.PIANO/SUB section parameters

No.	Category	Parameters
1	REVERB	🔑Type, 🔑Pre Delay, 🔑Time, Depth
2	EFX	Category, Type, Parameters (prm1~prm10, depending on EFX type)
	AMP	Amp Type, Drive, Level, Amp EQ Lo, Amp EQ Mid, Amp EQ Hi, Mid Freq., Mic Type, Mic Position, Ambience
3	Sound	Volume, Panpot, Filter Cut-off, Filter Resonance, DCA Attack Time, DCA Decay Time, DCA Sustain Level, DCA Release Time, DCF Attack Time, DCF Attack Level, DCF Decay Time, DCF Sustain Level, DCF Release Time, DCF Touch Depth, DCA Touch Depth, Vibrate Depth, Vibrate Rate, Vibrate Delay, Octave Layer Switch, Octave Layer Level, Octave Layer Range, Octave Layer Detune, Layer Vocal, Layer Bell, Layer Air
4	Tuning	Fine Tune, Stretch Tuning, Temperament, Key of Temperament
5	Key Setup	Key Range Type, 🔑Split Point, Key Range Zone Lo, Key Range Zone Hi, Octave Shift, Touch Curve, Zone Transpose, Key Scaling Damping, Key Scaling Key, Dynamics, User Key Volume
6	Controllers	Right Pedal, 🔑Right Pedal Assign, Soft Pedal Depth, Damper Pedal Mode, Center Pedal, 🔑Center Pedal Assign, Left Pedal, 🔑Left Pedal Assign, Pitch Bend, Pitch Bend Range, Modulation Wheel, Modulation Wheel Assign, Expression Pedal, 🔑Expression Pedal Assign
7	Knob Assign	Knob A Assign, Knob B Assign, Knob C Assign, Knob D Assign, Knob2 A Assign, Knob2 B Assign, Knob2 C Assign, Knob2 D Assign
8	Virtual Technician	PIANO: Voicing, Stereo Width, String Resonance, Damper Resonance, Key-off Effect, Damper Noise, Hammer Delay, Fall-back Noise, Topboard, Brilliance E.PIANO/SUB*: Key-off Noise, Key-off Delay

* SUB section Virtual Technician parameters applicable to Harpsichord and Bass sounds only.

Entering the EDIT Menu

When either the PIANO, E.PIANO, or SUB section is selected:

Press the EDIT button.

The LED indicator for the EDIT button will turn ON, and the Edit Menu for the selected section will be shown in the LCD display.

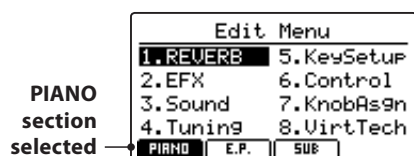

* To change the selected sound section, press the F1~F3 buttons.

■ Selecting the parameter category

After entering the EDIT Menu:

Press the CURSOR buttons to select the desired category, then press the +/YES button to enter the selected category.

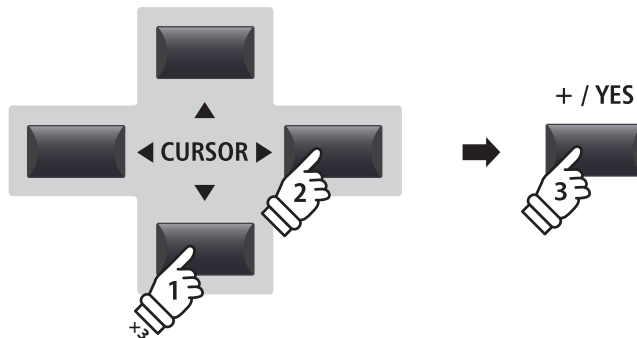
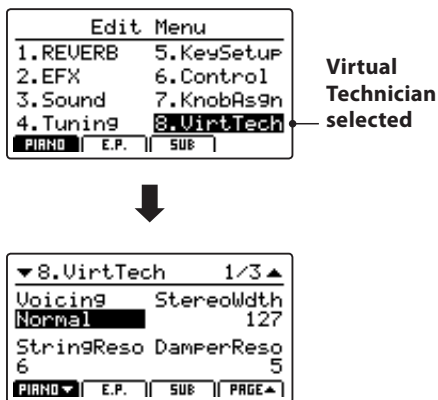

Example: To enter the Virtual Technician category, press the CURSOR◀ button three times and the CURSOR▶ button once, then press the +/YES button.

■ Adjusting parameters

After selecting the parameter category:

Turn the four control knobs (A, B, C, D) to adjust the parameters assigned to those knob.

Parameters can also be adjusted by using the CURSOR buttons to move the selection cursor, and +/YES or -/NO buttons to increase or decrease the value of the selected parameter.

Press the EXIT button to exit the parameter category, or return to the Play Mode screen.

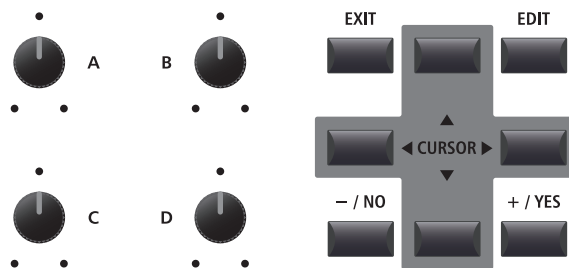

⚠ Parameter adjustments made to the selected sound will be lost upon selecting another sound.
 * To store the adjusted sound, use the STORE button (page 59).

■ Quick Compare function

The Quick Compare function allows any sound being adjusted to be compared 'on the fly' with the previously stored (i.e. preset) sound.

While in EDIT mode:

Press the variation button of the sound that is being adjusted.

The LED for the variation button will start to flash, and the keyboard will play the previously stored sound.

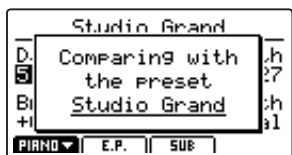

Press the variation button again.

The LED for the variation button will stop flashing, turn ON, and the keyboard will return to playing the adjusted sound.



Example: To compare the adjusted Studio Grand sound with the previously stored version, press the 2nd variation button of the PIANO section.

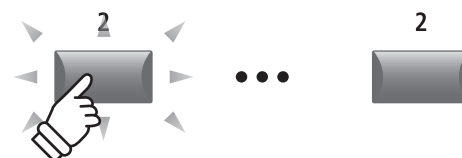

EDIT Menu parameters (PIANO, E.PIANO, SUB)

1 Reverb

1. Type

6 TYPES

This parameter selects the reverb type.

- * For more information about reverb, please refer to page 22.
- * This parameter is common for all three sound sections.
- * This parameter is not stored to SOUND but to SETUP only.

2. Pre Delay

VALUE: 0 ~ 200 MS

This parameter adjusts the delay time before the start of the reverberation.

- * For more information about reverb, please refer to page 22.
- * This parameter is common for all three sound sections.
- * This parameter is not stored to SOUND but to SETUP only.

3. Time

VALUE: 300 MS ~ 10.0 S

This parameter adjusts the reverb time.

- * For more information about reverb, please refer to page 22.
- * This parameter is common for all three sound sections.
- * This parameter is not stored to SOUND but to SETUP only.

4. Depth

VALUE: 0 ~ 127

This parameter adjusts the reverb depth.

- * For more information about reverb, please refer to page 22.

2.1 EFX

1. Category

23 CATEGORIES

This parameter selects the effect category.

- * For more information about effects, please refer to page 23.
- * The E.PIANO section lists two pages for EFX1 and EFX2.

2. Type

129 TYPES

This parameter selects the effect type.

- * For more information about effects, please refer to page 23.
- * The E.PIANO section lists two pages for EFX1 and EFX2.

3. Parameters

N/A

These parameters change depending on the selected EFX type, and are used to adjust the mixing amount of the effected (wet) and bypassed (dry) sound, depth, speed, feedback, etc.

- * For more information about effects, please refer to page 23.

2.2 Amp Simulator (E.PIANO)

1. Amp Type

5 TYPES

This parameter selects the simulated amplifier type.

* For more information about the various Amp Simulator model types, please refer to page 25.

3. Level

VALUE: 0 ~ 127

This parameter adjusts the volume of the simulated amplifier.

* For more information about the Amp Simulator, please refer to page 24.

4. Amp EQ Lo

VALUE: -10 dB ~ +10 dB

This parameter adjusts the level of the low frequencies of the simulated amplifier.

* This parameter functions independently of the global EQ.

* For more information about the Amp Simulator, please refer to page 24.

6. Amp EQ Hi

VALUE: -10 dB ~ +10 dB

This parameter adjusts the level of the high frequencies of the simulated amplifier.

* For more information about the Amp Simulator, please refer to page 24.

* This parameter functions independently of the global EQ.

8. Mic Type

CONDENSER, DYNAMIC

This parameter selects the type of microphone used for the simulated amplifier.

Mic Type	Description
Condenser	A microphone with a very broad frequency response that is typically found in studios.
Dynamic	A microphone with a more limited frequency response that is typically used for live playing.

* For more information about the Amp Simulator, please refer to page 24.

10. Ambience

VALUE: 0 ~ 127

This parameter adjusts the level (mix ratio) of an additional set of stereo microphones, that are placed away from the simulated amplifier in order to capture the ambient sound within a room.

* For more information about the Amp Simulator, please refer to page 24.

2. Drive

VALUE: 0 ~ 127

This parameter adjusts the amount of overdrive produced by the simulated amplifier.

* For more information about the Amp Simulator, please refer to page 24.

5. Amp EQ Mid

VALUE: -10 dB ~ +10 dB

This parameter adjusts the level of the mid frequencies of the simulated amplifier.

* This parameter functions independently of the global EQ.

* For more information about the Amp Simulator, please refer to page 24.

7. Mid Frequency

VALUE: 200 Hz ~ 3150 Hz

This parameter adjusts the mid frequency band of the simulated amplifier, levelled by the Amp EQ Mid parameter.

* For more information about the Amp Simulator, please refer to page 24.

* This parameter functions independently of the global EQ.

9. Mic Position

ON AXIS, OFF AXIS

This parameter selects the position of the microphone used for the simulated amplifier.

Mic Position	Description
On Axis	The microphone is placed in the centre of the speaker, producing a direct, aggressive sound with strong high/mid range.
Off Axis	The microphone is placed to the side of the speaker, producing a smoother and more ambient sound.

* For more information about the Amp Simulator, please refer to page 24.

3 Sound

1. Volume

VALUE: 0 ~ 127

This parameter adjusts the volume level of the selected sound independently of the section's volume fader.

3. Filter Cut-off

VALUE: -64 ~ +63

This parameter adjusts the frequency of the cut-off. Raising the cut-off level increases the brightness of the sound, while lowering the cut-off level results in a duller sound.

5. DCA Attack Time

VALUE: -64 ~ +63

This parameter adjusts the length of the attack. Higher values increase the attack time, resulting in a longer, slower attack for the selected sound.

7. DCA Sustain Level

VALUE: -64 ~ +63

This parameter adjusts the volume level of the sustain heard while the key is held for the selected sound.

9. DCF Attack Time

VALUE: -64 ~ +63

This parameter adjusts the length of the filter's attack. Higher values increase the attack time, resulting in a longer, slower attack for the filter.

11. DCF Decay Time

VALUE: -64 ~ +63

This parameter adjusts the length of the decay from peak level to sustain level for the filter.

13. DCF Release Time

VALUE: -64 ~ +63

This parameter adjusts the amount of time required for the filter to fade out after the keys are released.

15. DCA Touch Depth

VALUE: -64 ~ +63

This parameter adjusts how much the velocity affects the amplitude envelope depth.

2. Panpot

VALUE: L64 ~ R63

This parameter adjusts the left/right position of the selected sound within the stereo field.

4. Filter Resonance

VALUE: -64 ~ +63

This parameter adjusts the amount of the harmonic overtone around the cut-off frequency for the selected sound.

6. DCA Decay Time

VALUE: -64 ~ +63

This parameter adjusts the length of the decay from peak level to sustain level for the selected sound.

8. DCA Release Time

VALUE: -64 ~ +63

This parameter adjusts the amount of time required for the sound to fade out after the keys are released for the selected sound.

10. DCF Attack Level

VALUE: -64 ~ +63

This parameter adjusts the level of the filter's attack.

12. DCF Sustain Level

VALUE: -64 ~ +63

This parameter adjusts the level of the filter's sustain heard while the key is held for the selected sound.

14. DCF Touch Depth

VALUE: -64 ~ +63

This parameter adjusts how much the velocity affects the filter envelope depth.

■ About DCA Parameters

The DCA (Digitally Controlled Amplifier) parameters, are used to adjust the volume level of a sound over time using an envelope. The diagram below indicates the MP11's DCA parameters.

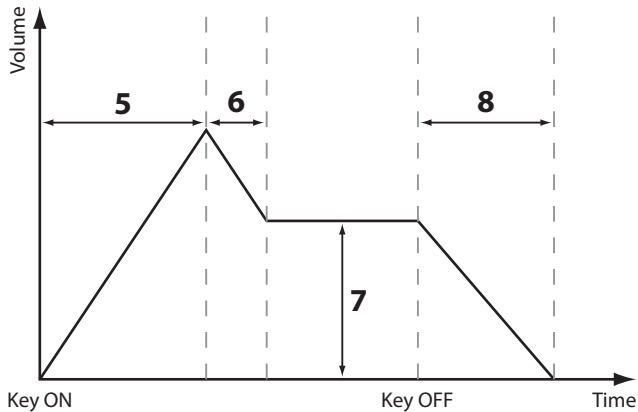

16. Vibrate Depth

VALUE: -64 ~ +63

This parameter adjusts the depth of the vibration applied to the selected sound.

18. Vibrate Delay

VALUE: -64 ~ +63

This parameter adjusts the delay time before the start of the vibration.

19. Octave Layer Switch

OFF, ON

This parameter turns the additional Octave Layer ON or OFF.

21. Octave Layer Range

VALUE: -2 ~ +2

This parameter sets the amount of octave transposition for the Octave Layer.

23. Layer Vocal

VALUE: OFF, 1 ~ 127

This parameter adjusts the amount of Vocal sound that is added to the selected sound.

25. Layer Air

VALUE: OFF, 1 ~ 127

This parameter adjusts the amount of Air sound that is added to the selected sound.

■ About DCF Parameters

The DCF (Digitally Controlled Filter) parameters, are used to adjust a low-pass filter applied to the sound over time. The diagram below indicates the MP11's DCF parameters.

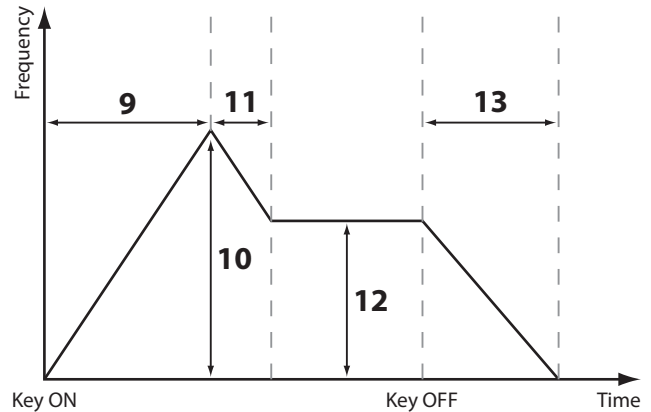

17. Vibrate Rate

VALUE: -64 ~ +63

This parameter adjusts the speed of the vibration applied to the selected sound.

20. Octave Layer Level

VALUE: 0 ~ 127

This parameter adjusts the volume level of the Octave Layer.

22. Octave Layer Detune

VALUE: -64 ~ +63

This parameter adjusts the tuning of the Octave Layer.

24. Layer Bell

VALUE: OFF, 1 ~ 127

This parameter adjusts the amount of Bell sound that is added to the selected sound.

4 Tuning

1. Fine Tune

VALUE: -64 ~ +63

This parameter adjusts the tuning of the selected sound for values smaller than a semi-tone.

2. Stretch Tuning

9 TYPES + 5 USER

This parameter selects the level of stretch tuning.

The human ear typically detects high and low frequencies less accurately than those frequencies within the middle range. The tuning of an acoustic piano is therefore 'stretched' to compensate, ensuring that the sound will be heard more naturally to the ears.

3. Temperament

7 TYPES + 2 USER

This parameter selects the tuning system of the selected sound.

* For information about creating User Temperaments, please refer to the User Edit explanation in the SYSTEM menu chapter (page 105).

4. Key of Temperament

RANGE: C ~ B

This parameter selects the key of the selected temperament. When using a temperament other than Equal Temperament, use this setting to specify the key signature of the piece.

* This parameter will only affect the 'balance' of the tuning system, the pitch of the keyboard will remain unchanged.

■ Temperament types

Temperament type	Description
Equal Temperament (Equal)	This is the most popular tuning method that divides the scale into twelve equal semi-tones. This produces the same chordal intervals in all twelve keys, and has the advantage of limitless modulation of the key. However, the tonality of each key becomes less characteristic and no chord is in pure consonance.
Pure Temperament (Pure Maj./Pure Min.)	This temperament, which eliminates dissonances for thirds and fifths is still popular for choral music because of its perfect harmony. When playing in a major key select 'Pure Maj' and when playing in a minor key select 'Pure Min'.
Pythagorean Temperament (Pythagorean)	This temperament, which uses mathematical ratios to eliminate dissonance for fifths, is very limited for use with chords, but it produces very characteristic melodic lines.
Meantone Temperament (Meantone)	This temperament, which uses a mean between a major and minor whole tone to eliminate dissonance for thirds, was devised to eliminate the lack of consonances experienced with certain fifths for the Mersenne pure temperament. It produces chords that are more beautiful than those with the equal temperament.
Werkmeister III Temperament (Werkmeis) Kirnberger III Temperament (Kirnberg)	These two temperaments are placed in between Meantone and Pythagorean. For music with few accidentals, this temperament produces the beautiful chords of the mean tone, but as accidentals increase, the temperament produces the characteristic melodies of the Pythagorean temperament. They are used primarily for classical music written in the Baroque era to revive the original characteristics.
User Temperament (Sys.User1/2)	User defined temperament created by raising or lowering the pitch for each semi-tone.

* For information about creating User Temperaments, please refer to the User Edit explanation in the SYSTEM menu chapter (page 105).

5 Key Setup

1. Key Range Type

OFF, UPPER, LOWER, ZONE

This parameter selects the Key Range type for the selected section.

Type	Description
Off	The sound is used for all 88 keys of the keyboard.
Upper	The sound is used for the upper split.
Lower	The sound is used for the lower split.
Zone	The sound is used for a defined zone between two keys.

* This parameter is not stored to SOUND but to SETUP only.

3. Key Range Zone Lo

RANGE: A-1 ~ C7

This parameter defines the bottom key of the key range zone.

* For more information about Key Range functions, please refer to page 26.

5. Octave Shift

VALUE: -3 ~ +3 OCTAVES

This parameter adjusts the amount of octave transposition for the selected sound.

7. Zone Transpose

VALUE: -12 ~ +12

This parameter adjusts the amount of transposition for the selected sound.

9. Key Scaling Key

RANGE: A-1 ~ C7

This parameter defines the point on the keyboard from which Key Scaling Damping should be applied, up to the highest key.

11. User Key Volume

OFF, 5 USER

This parameter selects the User Key Volume memory for the selected sound section, if desired.

* For information about creating User Key Volumes, please refer to the User Edit explanation in the SYSTEM menu chapter (page 106).

2. Split Point

RANGE: A-1 ~ C7

This parameter defines the point on the keyboard at which the upper and lower parts are divided.

* For more information about Key Range functions, please refer to page 26.

* This parameter is common for all three sound sections and all MIDI zones.

4. Key Range Zone Hi

RANGE: A-1 ~ C7

This parameter defines the top key of the key range zone.

* For more information about Key Range functions, please refer to page 26.

6. Touch Curve

6 TYPES + 5 USER

This parameter selects the touch response curve of the keyboard for the selected sound.

* For more information about touch curve types, please refer to page 46.

* For information about creating User Touch Curves, please refer to the User Edit explanation in the SYSTEM menu chapter (page 104).

8. Key Scaling Damping

ON, OFF

This parameter determines whether or not damping (velocity reduction) should be applied to a sound over a specific range.

This parameter may be useful when layering a piano sound with a strings sound, in order to reduce the level of the strings in the higher key range.

10. Dynamics

VALUE: OFF, 1 ~ 10

This parameter adjusts the keyboard response (velocity compression) of the selected sound independently of the touch curve.

When the value is 10 (default), the keyboard response is normal. As the value decreases the keyboard response gradually becomes less dynamic, and when set to OFF becomes completely flat (i.e. fixed touch response).

* For more information about dynamics, please refer to page 46.

5 Key Setup (cont.)

■ Touch Curve types

Touch Curve	No.	Description
Light +	1	Requires less striking force to achieve a forte note. * This touch curve is intended for players with a very delicate touch.
Light	2	A louder volume is produced even when playing with a soft touch. * This touch curve is intended for players who are still developing finger strength.
Normal	3	Reproduces the standard touch sensitivity of a typical acoustic piano.
Heavy	4	Requires a heavier touch to produce a loud volume. * This touch curve is intended for players with stronger fingers.
Heavy +	5	Requires considerably more striking force to achieve a loud volume.
Off (constant)	6	A constant volume is produced regardless of how hard the keys are struck. * This touch curve is intended for playing sounds of instruments that have a fixed dynamic range (e.g. harpsichord).
User* (User 1~User 5)	-	A custom touch curve, created to suit an individual's personal playing style.

* For information about creating User touch curves, please refer to the User Edit explanation in the SYSTEM menu chapter (page 104).

■ Touch Curve graph

The illustration below provides a visual representation of the different Touch Curve types.

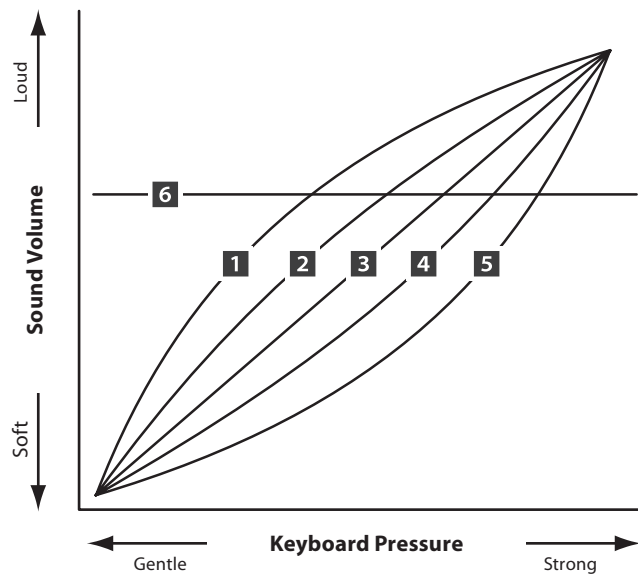

■ Dynamics graph

The illustration below provides a visual representation of the Dynamics parameter.

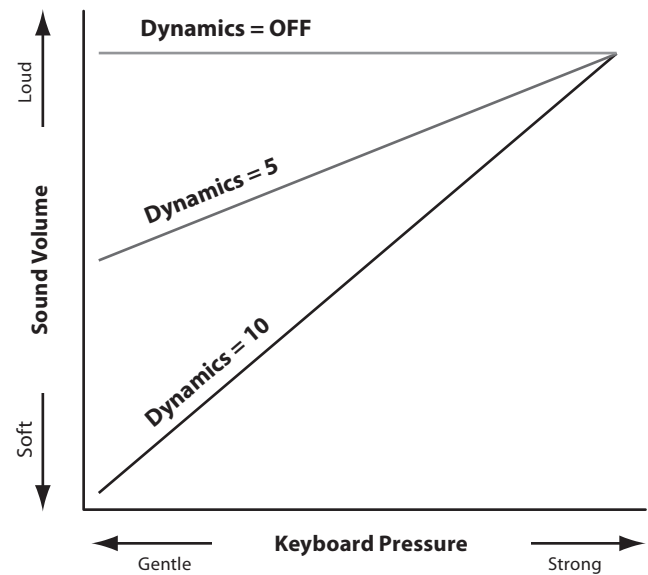

6 Controllers

1. Right Pedal

ON, OFF

This parameter determines whether or not the right pedal of the F-30 pedal unit is active for the selected section.

3. Soft Pedal Depth

VALUE: 1 ~ 10

This parameter adjusts the effectiveness (i.e. depth/strength) of the soft pedal.

5. Center Pedal

ON, OFF

This parameter determines whether or not the centre pedal of the F-30 pedal unit is active for the selected section.

7. Left Pedal

ON, OFF

This parameter determines whether or not the left pedal of the F-30 pedal unit is active for the selected section.

9. Pitch Bend

ON, OFF

This parameter determines whether or not the pitch bend wheel is active for the selected section.

11. Modulation Wheel

ON, OFF

This parameter determines whether or not the modulation wheel is active for the selected section.

13. Expression Pedal

ON, OFF

This parameter determines whether or not the expression pedal (if connected) is active for the selected section.

* For more information about connecting pedals, please refer to page 18.

2. Right Pedal Assign

18 FUNCTIONS (PIANO, SUB)
28 FUNCTIONS (E.PIANO)

This parameter selects the function assigned to the right pedal of the F-30 pedal unit.

* This parameter is common for all three sound sections.

4. Damper Pedal Mode

NORMAL, HOLD

This parameter determines whether or not the damper pedal should sustain sounds indefinitely without decay.

6. Center Pedal Assign

This parameter selects the function assigned to the centre pedal of the F-30 pedal unit.

* This parameter is common for all three sound sections.

8. Left Pedal Assign

18 FUNCTIONS (PIANO, SUB)
28 FUNCTIONS (E.PIANO)

This parameter selects the function assigned to the left pedal of the F-30 pedal unit.

* This parameter is common for all three sound sections.

10. Pitch Bend Range

VALUE: 0 ~ 7

This parameter sets the range of the pitch bend wheel in semi-tone steps.

* The range differs for the internal sound (0~7) and MIDI (0~12) sections.

12. Modulation Wheel Assign

18 FUNCTIONS (PIANO, SUB)
28 FUNCTIONS (E.PIANO)

This parameter selects the function assigned to the MP11's modulation wheel.

14. Expression Pedal Assign

18 FUNCTIONS (PIANO, SUB)
28 FUNCTIONS (E.PIANO)

This parameter selects the function assigned to the expression pedal (if connected).

* This parameter is common for all three sound sections.

* For more information about connecting pedals, please refer to page 18.

■ Assignable pedal/modulation wheel functions

Function
Modulation
Panpot
Expression

Function
Damper
Sostenuto
Soft

Function
Resonance
Cut-off
EFX Parameter 1 ~ 10 (PIANO, SUB)
EFX1 Parameter 1 ~ 10, EFX2 Parameter 1 ~ 10 (E.PIANO)

7 Knob Assign

The Knob Assign screen is used to assign EDIT menu parameters to the four main control knobs A, B, C, and D for direct, real-time adjustment in Play Mode. Two groups of knob parameters (primary and secondary) can be assigned to each of the PIANO, E.PIANO, and SUB sections, providing extensive control over the selected sounds.

Assigning parameters to each knob

Enter the Knob Assign screen for the desired section.

Turn the four control knobs (A, B, C, D) to specify which parameter should be assigned to each control knob in Play Mode.

Parameters can also be assigned by using the CURSOR buttons to move the selection cursor, and +/YES or -/NO buttons to cycle through the available parameters.

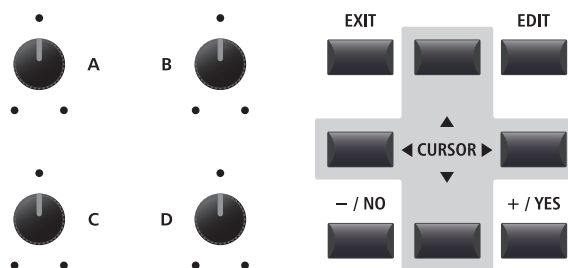

EDIT Menu



▼ arrow:
Next page

Press the F1~F3 buttons (depending on the selected section) or CURSOR ▲▼ buttons to show the secondary group of knob parameters in the LCD display.

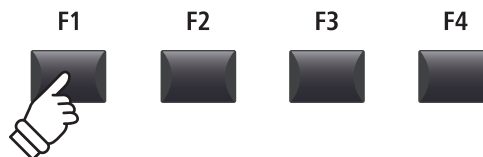

▲ arrow:
Prev. page

* Assignable parameters differ slightly for each sound section. For a full list of assignable parameters, please refer to the page 49.

* For more information about adjusting parameters in Play Mode, please refer to page 21.

About EFX parameter placeholder names (EFX Para1~10)

Some EFX offer a wide range of available parameters, while others are less flexible and feature fewer adjustable parameters. When assigning EFX parameters to the four control knobs, the names of the available parameters for the selected EFX (e.g. Wah:LowEQ) will be shown.

If the selected EFX features a smaller number of available parameters, a placeholder name (e.g. 'EFX Para 5') will be substituted in the Knob Assign menu, and the knob will become inactive in the main play screen.

Knob Assign screen
ClassichTch Wah selected,
LowEQ parameter assigned
to control knob D.

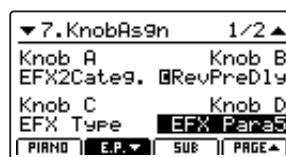
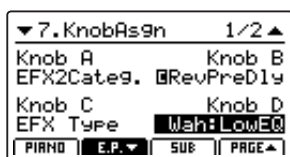

Knob Assign screen
LpfPdI Wah selected,
control knob D changes to
EFX Para5 parameter
(i.e. inactive).

Play screen
ClassichTch Wah selected,
control knob D shows
Wah:LowEQ parameter.

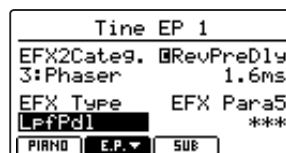

Play screen
LpfPdI Wah selected,
control knob D changes to
EFX Para5 (i.e. inactive).

■ Assignable control knob parameters

	PIANO	E.PIANO	SUB
1	<input checked="" type="checkbox"/> ReverbType	<input checked="" type="checkbox"/> ReverbType	<input checked="" type="checkbox"/> ReverbType
2	<input checked="" type="checkbox"/> Rev.PreDly	<input checked="" type="checkbox"/> Rev.PreDly	<input checked="" type="checkbox"/> Rev.PreDly
3	<input checked="" type="checkbox"/> ReverbTime	<input checked="" type="checkbox"/> ReverbTime	<input checked="" type="checkbox"/> ReverbTime
4	ReverbDpth	ReverbDpth	ReverbDpth
5	EFX Categ.	EFX Categ.	EFX Categ.
6	EFX Type	EFX Type	EFX Type
7	EFX Para1	EFX Para1	EFX Para1
8	EFX Para2	EFX Para2	EFX Para2
9	EFX Para3	EFX Para3	EFX Para3
10	EFX Para4	EFX Para4	EFX Para4
11	EFX Para5	EFX Para5	EFX Para5
12	EFX Para6	EFX Para6	EFX Para6
13	EFX Para7	EFX Para7	EFX Para7
14	EFX Para8	EFX Para8	EFX Para8
15	EFX Para9	EFX Para9	EFX Para9
16	EFX Para10	EFX Para10	EFX Para10
17	Volume	EFX2 Categ.	Volume
18	Panpot	EFX2 Type	Panpot
19	Cutoff	EFX2 Para1	Cutoff
20	Resonance	EFX2 Para2	Resonance
21	DCA Attack	EFX2 Para3	DCA Attack
22	DCA Decay	EFX2 Para4	DCA Decay
23	DCA Sustain	EFX2 Para5	DCA Sustain
24	DCA Release	EFX2 Para6	DCA Release
25	DCF ATK Tm	EFX2 Para7	DCF ATK Tm
26	DCF ATK Lv	EFX2 Para8	DCF ATK Lv
27	DCF Decay	EFX2 Para9	DCF Decay
28	DCF Sustain	EFX2 Para10	DCF Sustain
29	DCF Release	Amp Type	DCF Release
30	DCF TchDpt	Amp Level	DCF TchDpt
31	DCA TchDpt	Amp Drive	DCA TchDpt
32	Vib.Depth	AmpEQ-Lo	Vib.Depth
33	Vib.Rate	AmpEQ-Mid	Vib.Rate
34	Vib.Delay	AmpEQ-High	Vib.Delay
35	Octave	MidFreq.	Octave
36	Oct.Level	AmpMicType	Oct.Level
37	Oct.Range	AmpMicPos.	Oct.Range
38	Oct.Detune	AmpAmbien.	Oct.Detune
39	Vocal	Volume	Vocal
40	Bell	Panpot	Bell
41	Air	Cutoff	Air
42	Fine Tune	Resonance	Fine Tune
43	Stretch	DCA Attack	Stretch
44	Temperment	DCA Decay	Temperment
45	Temper.Key	DCA Sustain	Temper.Key
46	KeyRange	DCA Release	KeyRange
47	<input checked="" type="checkbox"/> SpltPoint	DCF ATK Tm	<input checked="" type="checkbox"/> SpltPoint
48	Zone Lo	DCF ATK Lv	Zone Lo
49	Zone Hi	DCF Decay	Zone Hi
50	Touch	DCF Sustain	Touch

	PIANO	E.PIANO	SUB
51	OctavShift	DCFRelease	OctavShift
52	ZoneTrans.	DCF TchDpt	ZoneTrans.
53	KS-Damping	DCA TchDpt	KS-Damping
54	KS-Key	Vib.Depth	KS-Key
55	Dynamics	Vib.Rate	Dynamics
56	Right Ped.	Vib.Delay	Right Ped.
57	<input checked="" type="checkbox"/> R.Assign	Octave	<input checked="" type="checkbox"/> R.Assign
58	Damp.Mode	Oct.Level	Damp.Mode
59	SoftPdlDpt	Oct.Range	SoftPdlDpt
60	CenterPed.	Oct.Detune	CenterPed.
61	<input checked="" type="checkbox"/> C.Assign	Vocal	<input checked="" type="checkbox"/> C.Assign
62	Left Pedal	Bell	Left Pedal
63	<input checked="" type="checkbox"/> L.Assign	Air	<input checked="" type="checkbox"/> L.Assign
64	Pitch Bend	Fine Tune	Pitch Bend
65	Bend Range	Stretch	Bend Range
66	Mod.Wheel	Temperment	Mod.Wheel
67	Mod.Assign	Temper.Key	Mod.Assign
68	EXP Pedal	KeyRange	EXP Pedal
69	<input checked="" type="checkbox"/> EXPAssign	<input checked="" type="checkbox"/> SpltPoint	<input checked="" type="checkbox"/> EXPAssign
70	Voicing	Zone Lo	KeyOffNois *
71	StereoWdth	Zone Hi	KeyOffDly *
72	StringReso	Touch	
73	DamperReso	OctavShift	
74	KeyOffEff.	ZoneTrans.	
75	DamperNois	KS-Damping	
76	HammerDly	KS-Key	
77	FallbackNs	Dynamics	
78	Topboard	Right Ped.	
79	Brilliance	<input checked="" type="checkbox"/> R.Assign	
80		Damp.Mode	
81		SoftPdlDpt	
82		CenterPed.	
83		<input checked="" type="checkbox"/> C.Assign	
84		Left Pedal	
85		<input checked="" type="checkbox"/> L.Assign	
86		Pitch Bend	
87		Bend Range	
88		Mod.Wheel	
89		Mod.Assign	
90		EXP Pedal	
91		<input checked="" type="checkbox"/> EXPAssign	
92		KeyOffNois	
93		KeyOffDly	

* SUB section Virtual Technician parameters applicable to Harpsichord and Bass sounds only.

8 Virtual Technician (PIANO section)

1. Voicing

6 TYPES

This parameter attempts to recreate the technique of adjusting the action, hammers and strings of an acoustic piano, allowing the tonal character and dynamics of the MP11's piano sounds to be dramatically altered.

■ Voicing types

Voicing Type	Description
Normal	The normal tonal character of an acoustic piano throughout the entire dynamic range.
Mellow 1	A softer, more mellow tonal character throughout the entire dynamic range.
Mellow 2	An even softer tonal character than Mellow 1.
Dynamic	A tonal character that changes dramatically from mellow to bright, depending on the strength of key strike.
Bright 1	A bright tonal character throughout the entire dynamic range.
Bright 2	An even brighter tonal character than Bright 1.

2. Stereo Width

VALUE: 0 ~ 127

This parameter adjusts the width of the stereo sound.

3. String Resonance

VALUE: OFF, 1 ~ 10

This parameter adjusts the volume of the string resonance.

String Resonance refers to a phenomenon that exists in acoustic pianos whereby the strings of held notes resonate 'sympathetically' with other notes of the same harmonic series.

4. Damper Resonance

VALUE: OFF, 1 ~ 10

This parameter adjusts the volume of the damper resonance.

Depressing the damper pedal of an acoustic piano raises all dampers, allowing the strings to vibrate freely. When a note or chord is played on the piano with the sustain pedal depressed, not only will the strings of the notes played vibrate, but also the strings of other notes, vibrating in sympathetic resonance.

5. Key-off Effect

VALUE: OFF, 1 ~ 10

This parameter adjusts the volume of the key-off effect.

When playing an acoustic piano - particularly in the bass region of the keyboard - if a key is played with force and released quickly, it is often possible to hear the faint sound of the damper touching the strings immediately before the vibrations are stopped.

6. Damper Noise

VALUE: OFF, 1 ~ 10

This parameter adjusts the volume of the damper noise.

When the damper pedal is depressed and released, it is often possible to hear the sound of the damper head touching and releasing the strings.

7. Hammer Delay

VALUE: OFF, 1 ~ 10

This parameter adjusts the delay of the hammer striking the string when playing with pianissimo.

8. Fall-back Noise

VALUE: OFF, 1 ~ 10

This parameter adjusts the volume of the noise heard when the keyboard action 'falls back' after a key is released.

9. Topboard

CLOSE, OPEN1, OPEN2, OPEN3

This parameter changes the position of the piano's topboard.

When playing an acoustic grand piano, the position of the instrument's topboard (lid) affects both the volume and 'openness' of the tone produced. A fully open topboard allows sound waves to reflect off the polished lid surface and project into the room, while a closed lid has the opposite effect, resulting in a darker, more opaque tone.

10. Brilliance

VALUE: -10 dB ~ +10 dB

This parameter adjusts the overall brightness of the piano sound independently of the Voicing parameter.

8 Virtual Technician (E.PIANO, SUB sections)

1. Key-off Noise

VALUE: OFF, 1 ~ 127

When the E.PIANO sound section is selected, this parameter adjusts the volume of the noise heard when the keys of an electromechanical instrument are released.

When the SUB section is selected, this parameter adjusts the volume of the release noise for harpsichord and bass sounds.

2. Key-off Delay

VALUE: 0 ~ 127

This parameter adjusts the delay time before the Key-off Noise is heard.

Overview of the EDIT Menu (MIDI OUT)

The EDIT menu can also be used to adjust parameters for the MIDI OUT section. As with the sound section EDIT menus, the parameters are grouped by category, providing direct control over any connected MIDI devices.

This collection of parameters, together with other adjustable settings, can be stored as a SETUP memory (page 60). The MP11 provides 26 banks x 8 setups, for a total of 208 user programmable SETUP memories.

About Common parameters (🔑 icon)

Unless stated, parameter settings for the MIDI OUT sections can be adjusted independent for each ZONE1~ZONE4. However, parameters marked with a 🔑 icon are common for all four MIDI zones. For example, changing the 🔑 Right Pedal Assign parameter for ZONE1 will automatically change the 🔑 Right Pedal Assign parameter for ZONE2~ZONE4. As noted previously, the 🔑 Split Point parameter is unique in that it is common for all three sound sections and four MIDI zones.

About System parameters (🔧 icon)

MIDI OUT section parameters marked with a 🔧 icon are SYSTEM parameters and memorised automatically, without the need to use the STORE function.

MIDI OUT section parameters

No.	Category	Parameters
1	Channel/Program	MIDI Transmitting Channel, Program, Bank MSB, Bank LSB
2	SETUP	Send Program, Send Bank, Send Volume, Send Knobs
3	Transmit 🔧	Transmit System Exclusive, Transmit Recorder
4	MMC 🔧	Transmit MMC, MMC Device ID, MMC Commands
5	Key Setup	Key Range Type, 🔑 Split Point, Key Range Zone Lo, Key Range Zone Hi, Octave Shift, Touch Curve, Zone Transpose, Key Scaling Damping, Key Scaling Key, Dynamics, Solo, Solo Mode, Transmit Keyboard
6	Controllers	Right Pedal, 🔑 Right Pedal Assign, Half Pedal Values, Center Pedal, 🔑 Center Pedal Assign, Left Pedal, 🔑 Left Pedal Assign, Pitch Bend, Pitch Bend Range, Modulation Wheel, Modulation Wheel Assign, Expression Pedal, 🔑 Expression Pedal Assign
7	Knob Assign	Knob A Assign, Knob B Assign, Knob C Assign, Knob D Assign, Knob2 A Assign, Knob2 B Assign, Knob2 C Assign, Knob2 D Assign

Entering the EDIT Menu

When MIDI OUT ZONE1~ZONE4 is selected:

Press the EDIT button.

The LED indicator for the EDIT button will turn ON, and the Edit Menu for the selected MIDI zone will be shown in the LCD display.

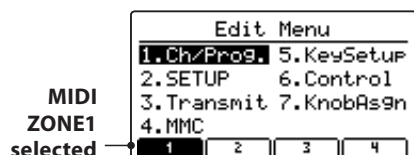

* To change the selected MIDI zone, press the F1~F4 buttons.

■ Selecting the parameter category

After entering the EDIT Menu:

Press the CURSOR buttons to select the desired category, then press the +/YES button to enter the selected category.

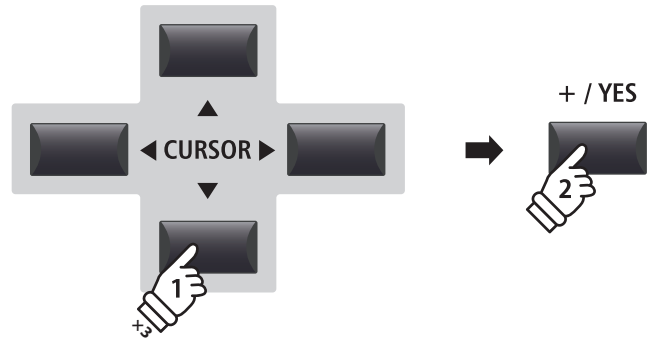
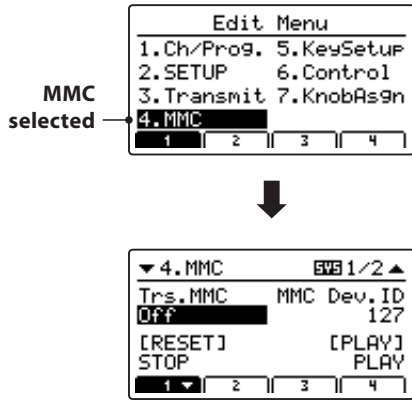

Example: To enter the MMC category, press the CURSOR▼ button three times, then press the +/YES button.

■ Adjusting parameters

After selecting the parameter category:

Turn the four control knobs (A, B, C, D) to adjust the parameters assigned to those knob.

Parameters can also be adjusted by using the CURSOR buttons to move the selection cursor, and +/YES or -/NO buttons to increase or decrease the value of the selected parameter.

Press the EXIT button to exit the parameter category, or return to the Play Mode screen.

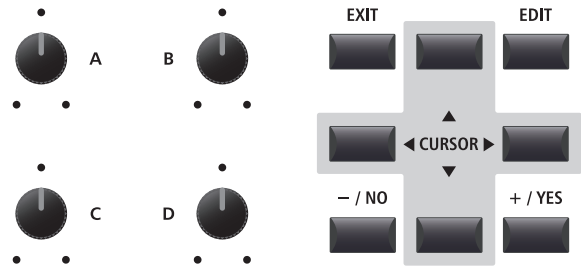

EDIT Menu parameters (MIDI OUT)

1 Channel/Program

1. MIDI Transmitting Channel VALUE: 01CH ~ 16CH

This parameter determines which MIDI channel will be used to transmit event information for the selected Zone.

- * By default, ZONE1~ZONE4 are assigned MIDI channels 01~04.
- * The specified MIDI transmit channel should match the MIDI Receive channel of the connected MIDI device.

3/4. Bank MSB/Bank LSB VALUE: 0 ~ 127

This parameter determines which MSB and LSB number will be transmitted when a SETUP is recalled. The MIDI standard allocates 128 storage spaces, however this number can be expanded using an MSB and an LSB.

The diagram to the right illustrates how the Program Number, MSB Bank, and LSB Bank are organised.

- * Please refer to the owner's manual of the connected MIDI device for further information.

2. Program VALUE: 1 ~ 128

This parameter determines which Program Change Number will be transmitted when a SETUP is recalled. For example, the desired Program number of a sound on the external MIDI device.

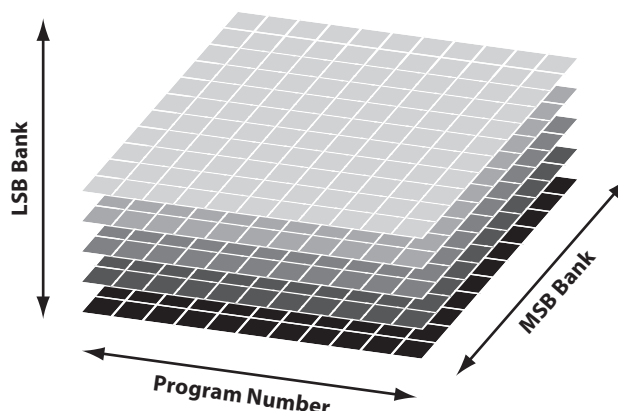

2 SETUP

1. Send Program ON, OFF

This parameter determines whether or not a Program Change Number will be transmitted when a SETUP is recalled.

To change sounds on external MIDI devices when recalling a SETUP, set this parameter to ON.

3. Send Volume ON, OFF

This parameter determines whether or not an initial MIDI Volume message will be transmitted when a SETUP is recalled.

- * Adjusting the volume of a Zone by turning the control knobs will still transmit values even if this parameter is set to OFF.

2. Send Bank ON, OFF

This parameter determines whether or not Program Bank Numbers (MSB, LSB) will be transmitted when a SETUP is recalled.

If the external MIDI device requires a Bank Select message, set this parameter to ON.

4. Send Knobs ON, OFF

This parameter determines whether or not control knob settings will be transmitted (ON) or not (OFF) when a SETUP is recalled.

- * Turning the control knobs will still transmit values even if this parameter is set to OFF.

■ SETUP parameters in the SYSTEM menu

The above Send parameters can be overridden by the SETUP Program, SETUP Bank, SETUP Volume, SETUP Knobs parameters in the MIDI category of the SYSTEM menu (page 102).

When these SETUP parameters are set to OFF, an asterisk will be shown beside the relevant Send parameter to indicate that the EDIT menu setting is being overridden.

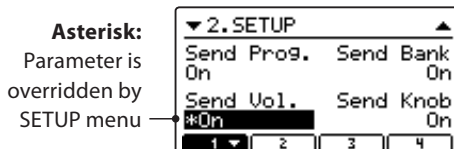

3 Transmit EYE

The Transmit category parameters are all SYSTEM parameters. These parameters are memorised automatically and therefore do not need to be stored to each SETUP.

1. Transmit System Exclusive ON, OFF

This parameter determines whether or not System Exclusive (SYSEX) data will be transmitted to an external MIDI device.

* For more information about System Exclusive data transmitted by the MP11, please refer to page 127.

2. Transmit Recorder ON, OFF

This parameter determines whether or not data will be transmitted to an external MIDI device when playing internal recorder songs.

4 MMC EYE

The MMC category parameters are all SYSTEM parameters. These parameters are memorised automatically and therefore do not need to be stored to each SETUP.

1. Transmit MMC ON, OFF

This parameter determines whether or not the MP11's recorder control buttons will transmit MMC (MIDI Machine Control) data.

2. MMC Dev. ID VALUE: 0 ~ 127

This parameter determines the device ID of the MMC (MIDI Machine Control).

3. MMC Commands 13 MMC COMMANDS, 3 REALTIME COMMANDS

These parameters allow MMC or Realtime commands to be assigned to the MP11's six recorder control buttons.

* By default, the main MMC commands should be correctly mapped to the MP11's recorder control buttons.

■ Assignable recorder control commands

MMC Commands			
01	STOP	08	RECORD PAUSE
02	PLAY	09	PAUSE
03	DEFERRED PLAY	0A	EJECT
04	FAST FORWARD	0B	CHASE
05	REWIND	0C	COMMAND ERROR RESET
06	RECORD STROBE	0D	MMC RESET
07	RECORD EXIT		

Realtime Commands	
FA	Realtime START
FB	Realtime CONTINUE
FC	Realtime STOP

■ Recorder control buttons

The illustration below indicates the names of the six recorder control buttons:

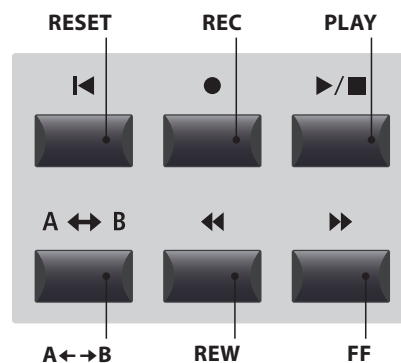

5 Key Setup

1. Key Range Type OFF, UPPER, LOWER, ZONE

This parameter selects the Key Range type for the selected zone.

Type	Description
Off	The zone is used for all 88 keys of the keyboard.
Upper	The zone is used for the upper split.
Lower	The zone is used for the lower split.
Zone	The zone is used for a defined zone between two keys.

* This parameter is not stored to SOUND but to SETUP only.

5. Octave Shift VALUE: -3 ~ +3 OCTAVES

This parameter adjusts the amount of octave transposition for the selected zone.

7. Zone Transpose VALUE: -12 ~ +12

This parameter adjusts the amount of transposition for the selected zone.

9. Key Scaling Key RANGE: A-1 ~ C7

This parameter defines the point on the keyboard from which Key Scaling Damping should be applied, up to the highest key.

11. Solo ON, OFF

This parameter determines whether or not playing will be restricted to single notes, even when more than one note is played simultaneously.

This parameters can be used to effectively simulate the performance characteristics of a monophonic synthesizer.

13. Transmit Keyboard ON, OFF

This parameter determines whether or not keyboard Key ON/Key OFF event data will be transmitted to an external MIDI device.

2. Split Point RANGE: A-1 ~ C7

This parameter defines the point on the keyboard at which the upper and lower parts are divided.

* For more information about Key Range functions, please refer to page 26.

* This parameter is common for all three sound sections and all MIDI zones.

3./4. Key Range Zone Lo/Hi RANGE: A-1 ~ C7

These parameters define the bottom and top keys of the key range zone.

* For more information about Key Range functions, please refer to page 26.

6. Touch Curve 6 TYPES + 5 USER

This parameter selects the touch response curve of the keyboard for the selected zone.

* For more information about touch curve types, please refer to page 46.

* For information about creating User Touch Curves, please refer to the User Edit explanation in the SYSTEM menu chapter (page 104).

8. Key Scaling Damping ON, OFF

This parameter determines whether or not damping (velocity reduction) should be applied to a zone over a specific range.

10. Dynamics VALUE: OFF, 1 ~ 10

This parameter adjusts the keyboard response (velocity compression) of the selected zone independently of the touch curve.

* For more information about dynamics, please refer to page 46.

12. Solo Mode LAST, HIGH, LOW

This parameter selects the solo mode for the selected zone.

Solo Mode	Description
Last	Play the last note of a group of notes.
High	Play the highest note of a group of notes.
Low	Play the lowest note of a group of notes.

6 Controllers

1. Right Pedal

ON, OFF

This parameter determines whether or not the right pedal of the F-30 pedal unit is active for the selected zone.

2. Right Pedal Assign

CC#0 ~ CC#119, AFTERTOUCH

This parameter selects the function assigned to the right pedal of the F-30 pedal unit.

* This parameter is common for all four MIDI zones.

3. Half Pedal Values

NORMAL, HIGH, LOW

This parameter changes the half pedal ranges sent by the right pedal of the F-30 pedal unit for the selected zone.

This parameter is useful when using the MP11 to control external tone generators (e.g. software pianos) that respond to damper pedal behaviour differently.

Half Pedal Value	Value Range	Description
Normal (default)	0 ~ 127	The damper pedal sends a full range of evenly distributed values.
High	0, 64 ~ 127	The damper pedal sends a full range of evenly distributed values after the half-pedal point is reached.
Low	0 ~ 63, 127	The damper pedal sends a full range of evenly distributed values before the half-pedal point is reached.

4. Center Pedal

ON, OFF

This parameter determines whether or not the centre pedal of the F-30 pedal unit is active for the selected zone.

5. Center Pedal Assign

CC#0 ~ CC#119, AFTERTOUCH

This parameter selects the function assigned to the centre pedal of the F-30 pedal unit.

* This parameter is common for all four MIDI zones.

6. Left Pedal

ON, OFF

This parameter determines whether or not the left pedal of the F-30 pedal unit is active for the selected zone.

7. Left Pedal Assign

CC#0 ~ CC#119, AFTERTOUCH

This parameter selects the function assigned to the left pedal of the F-30 pedal unit.

* This parameter is common for all four MIDI zones.

8. Pitch Bend

ON, OFF

This parameter determines whether or not the pitch bend wheel is active for the selected zone.

9. Pitch Bend Range

VALUE: 0 ~ 12

This parameter sets the range of the pitch bend wheel in semi-tone steps.

* The range differs for the internal sound (0 ~7) and MIDI (0~12) sections.

10. Modulation Wheel

ON, OFF

This parameter determines whether or not the modulation wheel is active for the selected zone.

11. Modulation Wheel Assign

CC#0 ~ CC#119, AFTERTOUCH

This parameter selects the function assigned to the MP11's modulation wheel.

12. Expression Pedal

ON, OFF

This parameter determines whether or not the expression pedal (if connected) is active for the selected zone.

* For more information about connecting pedals, please refer to page 18.

13. Expression Pedal Assign

CC#0 ~ CC#119, AFTERTOUCH

This parameter selects the function assigned to the expression pedal (if connected).

* This parameter is common for all four MIDI zones.

* For more information about connecting pedals, please refer to page 18.

7 Knob Assign

The Knob Assign screen is used to assign MIDI Control Change or Aftertouch messages to the four main control knobs A, B, C, and D for direct, real-time adjustment in Play Mode. Two groups of knob parameters (primary and secondary) can be assigned to each of the four MIDI zones, providing extensive control over external MIDI devices.

■ Assigning MIDI CC/Aftertouch messages to each knob

Enter the Knob Assign screen for the desired MIDI zone.

Turn the four control knobs (A, B, C, D) to specify which MIDI CC message should be assigned to each control knob.

MIDI CC messages can also be assigned by using the CURSOR buttons to move the selection cursor, and +/-YES or -/NO buttons to increase or decrease the values.

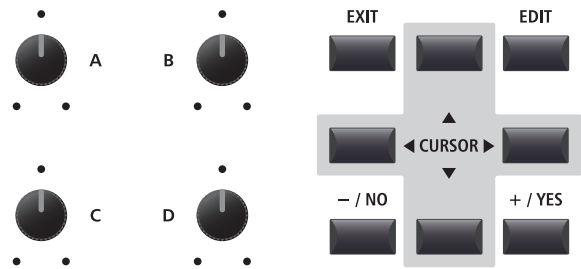

EDIT Menu

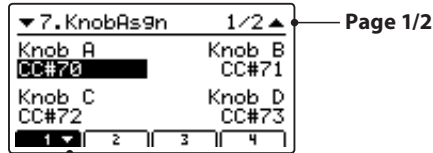

▼ arrow:
Next page

Press the F1~F4 buttons (depending on the selected MIDI zone) to show the secondary group of knob parameters in the LCD display.

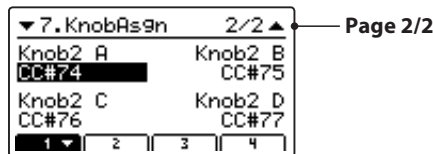

* For more information about adjusting parameters in Play Mode, please refer to page 21.

Overview of the STORE Button

After using the EDIT menu and control knobs to adjust the parameters for the selected sound, the STORE button is used to memorise the settings, and ensure the changes are not lost when turning the instrument OFF or selecting other sounds.

The STORE button has three different functions: to store individual sounds, to store the entire panel configuration (SETUP), and to store the current panel configuration as the default (POWERON).

■ STORE button functions

STORE function	Description
SOUND	Store the selected sound's EDIT menu parameters* to the variation button.
SETUP	Store all EDIT menu parameters, all sound section panel settings, and EQ section settings to a SETUP memory.
POWERON	Store all EDIT menu parameters, all sound section panel settings, and EQ section settings as the default.

* Common parameters are not stored to SOUND memory. For more information about common parameters, please refer to page 38.

1 Storing a SOUND

This function will store the selected sound's EDIT menu parameters to the variation button, thus overwriting the existing preset sound.

1. Entering the STORE screen

Press the STORE button.

The LED indicator for the STORE button will turn ON, and the store selection screen will be shown in the LCD display.

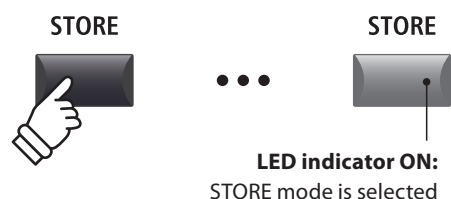

2. Selecting the Store Sound function

Press the F1 button (SOUND) to select the Store Sound function, then press the F4 button (EXEC).



The Store Sound confirmation screen will be shown in the LCD display.

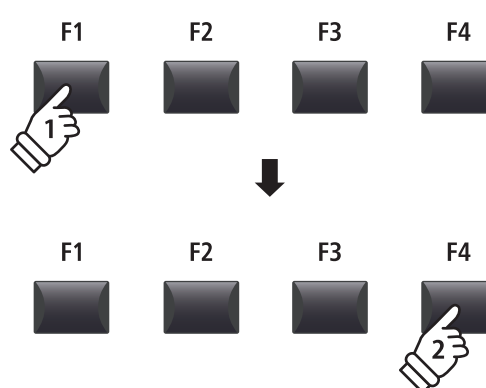
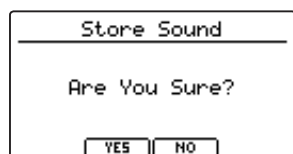

3. Confirming the Store Sound operation

Press the F2 button (YES) to confirm the Store Sound operation, or the F3 button (NO) to return to the store selection screen.

* The existing sound will be overwritten with the adjusted sound.

* The +/YES and -/NO buttons can also be used to confirm or cancel the store operation.

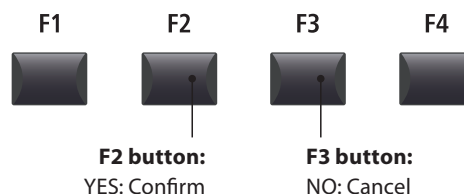

2 Storing a SETUP

This function will store all the EDIT menu parameters for the PIANO, E.PIANO, SUB, and MIDI OUT sections, panel button and knob states, and EQ settings to one of the MP11's 208 SETUP memories.

1. Entering the STORE screen

Press the STORE button.

The LED indicator for the STORE button will turn ON, and the store selection screen will be shown in the LCD display.

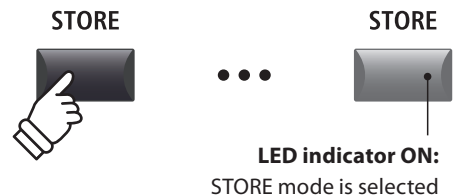

2. Selecting the Store Setup function

Press the F2 button (SETUP) to select the Store Setup function, then press the F4 button (EXEC).

The Store Setup screen will be shown in the LCD display.

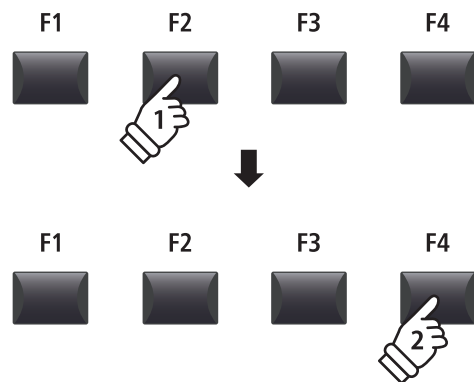

3. Naming the SETUP, selecting the bank/memory

Turn control knobs A and B to move the cursor position and select the characters for the SETUP name.

Press the BANK ◀ ▶ buttons and SETUP memory buttons (1~8) to select the bank and memory for the new SETUP.

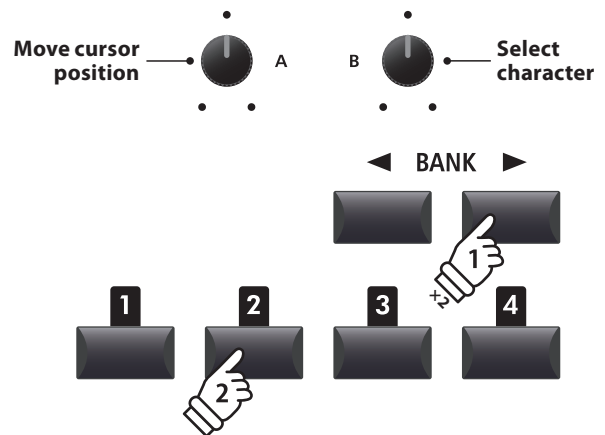

Press the F4 function button (EXEC).

The Store Setup confirmation screen will be shown in the LCD display.

Example: To select SETUP memory C-2, press the BANK ▶ button twice, then press the 2 memory button.

4. Confirming the Store Setup operation

Press the F2 button (YES) to confirm the Store Setup operation, or the F3 button (NO) to return to the previous screen.

- * The existing SETUP memory will be overwritten with the new SETUP.
- * The +/YES and -/NO buttons can also be used to confirm or cancel the store operation.
- * When the SETUP has been stored and the SETUP button has been turned OFF, the panel settings will return to the POWERON state.

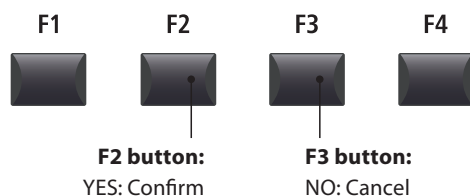

3 Storing POWERON settings

This function will store all the EDIT menu parameters for the PIANO, E.PIANO, SUB, and MIDI OUT sections, panel button and knob states, and EQ settings to the MP11's default POWERON memory.

1. Entering the STORE screen

Press the STORE button.

The LED indicator for the STORE button will turn ON, and the store selection screen will be shown in the LCD display.

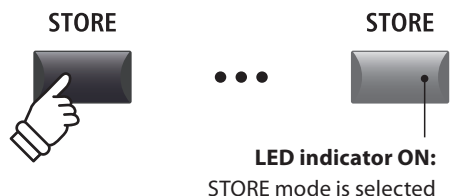

2. Selecting the Store PowerOn function

Press the F3 function button (PWRON) to select the Store PowerOn function, then press the F4 button (EXEC).

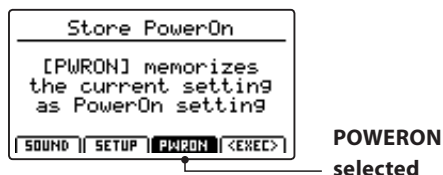

The Store PowerOn confirmation screen will be shown in the LCD display.

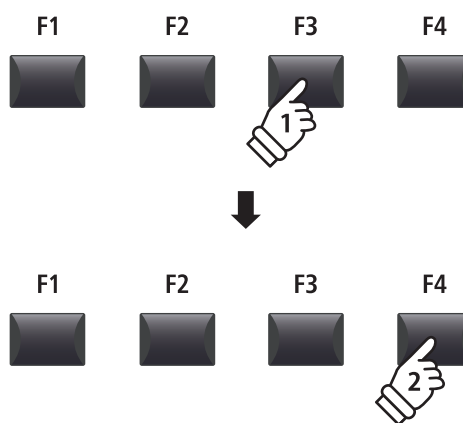
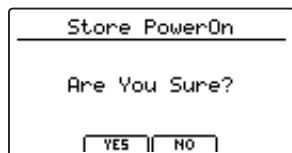

3. Confirming the Store PowerOn operation

Press the F2 button (YES) to confirm the Store PowerOn operation, or the F3 (NO) button to return to the previous screen.

* The existing POWERON memory will be overwritten.

* The +/YES and -/NO buttons can also be used to confirm or cancel the store operation.

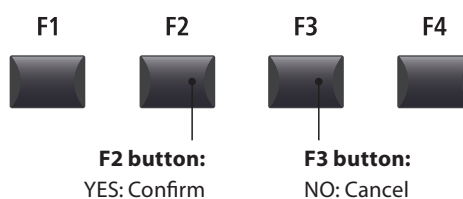

SETUP memories

The MP11's SETUP memories allow the entire instrument configuration, including selected sounds, section volume levels, parameter settings, and EQ adjustments, etc. to be stored and recalled immediately at the touch of a button. SETUPS are numbered 1~8, and arranged in 26 banks A~Z, allowing for a total of 208 individual memories.

This page explains how to select the bank and memory, and recall the SETUP.

Turning SETUP mode ON or OFF

Press the SETUP section's ON/OFF button to turn SETUP mode ON or OFF.

The LED indicators for the SETUP section's ON/OFF button and selected SETUP memory will turn ON or OFF accordingly.

When SETUP mode is turned ON, a list of SETUPS for the current bank will be briefly shown in the LCD display, with the selected memory highlighted.

* The previously selected SETUP memory will be recalled automatically.



After a few seconds, the Play mode screen will be shown in the LCD display, with the name of selected SETUP indicated.

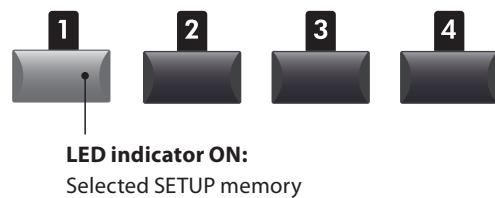
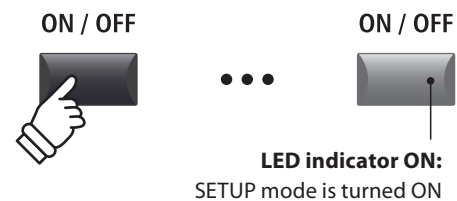

Selecting SETUPS

While SETUP mode is turned ON:

Press the BANK ◀ ▶ buttons to cycle through the available SETUP banks.

The SETUP list for the selected bank will be briefly shown in the LCD display.

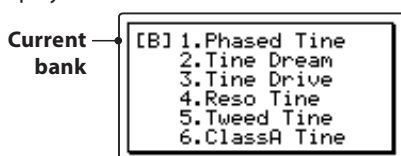

While the SETUP list is shown in the LCD display:

Press the SETUP memory buttons to select the desired SETUP memory.

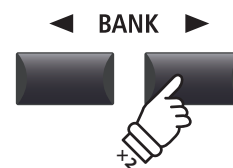
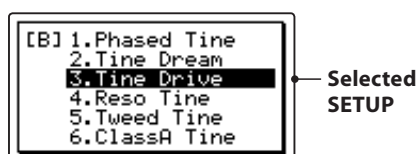

Example: To select bank B, press the BANK ▶ button twice.

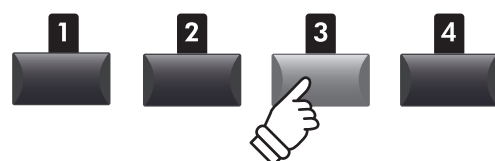

Example: To select SETUP memory 3, press the 3 SETUP memory button.

* SETUP memories from within the current bank can still be selected, even when the bank list is not shown.

Overview of the Recorder

The MP11's Recorder features convenient functions to record and playback performances from the instrument's internal memory or a connected USB memory device. The characteristics of each method are outlined below.

MP11 Recorder characteristics

	Song Recorder (Internal Memory)	Audio Recorder (USB Memory)
Stored/saved format	SMF (MIDI)	MP3/WAV (audio)
Maximum song length	90,000 notes	Depends on device capacity
Maximum no. of songs	10 songs	Depends on device capacity
Example applications	Sketching ideas, recording finished performances, remixing and further editing on a computer.	
		Emailing to friends, burning to audio CD, etc.
Playback methods	Playback songs on MP11 and other MIDI devices	Playback songs on MP11 and audio players etc.
Adjustable tempo	Yes, before and during playback	No
Overdubbing	No	Yes, unlimited overdubs
Conversion options	Can be converted to MP3/WAV	Cannot be converted to SMF (MIDI)

Turning Recorder mode ON or OFF

Press the RECORDER section's ON/OFF button to turn Recorder mode ON or OFF.

The LED indicator for the RECORDER section's ON/OFF button will turn ON or OFF accordingly.

When Recorder mode is turned ON, the recorder screen will be shown in the LCD display.

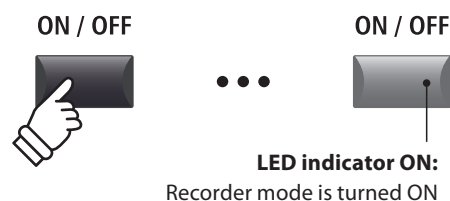

Selecting the Recorder mode

Press the F1 function button to alternate between the Internal Song Recorder and the USB Audio Recorder functions.

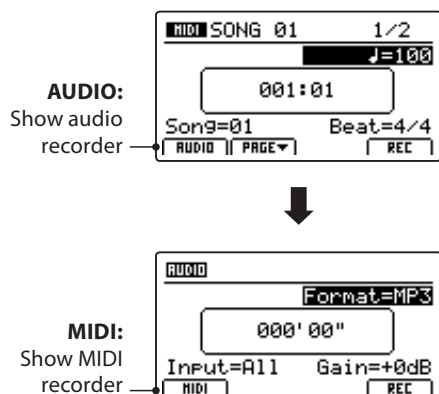

* If a USB memory device is connected when Recorder mode is turned ON, the USB Audio Recorder function will be selected automatically.

* If a USB memory device is not connected when Recorder mode is turned ON, the Internal Song Recorder function will be selected automatically.

USB Functions

Additional USB functions to delete and rename files stored on USB memory devices can be found in the USB Menu. For information about USB functions, please refer to page 92.

Song Recorder (Internal Memory)

The Song Recorder function allows up to 10 different songs to be recorded, stored in internal memory, and played back at the touch of a button. Once recorded, songs can be saved to USB memory in Standard MIDI File (SMF) format, or converted to MP3/WAV audio files.

1 Recording a song

1. Turning the Recorder mode ON

Press the RECORDER section's ON/OFF button to turn Recorder mode ON.

The LED indicator for the RECORDER section's ON/OFF button will turn ON, and the MIDI recorder screen will be shown in the LCD display.



If a USB memory device is connected, press the F1 button (MIDI) to select the MIDI recorder function.

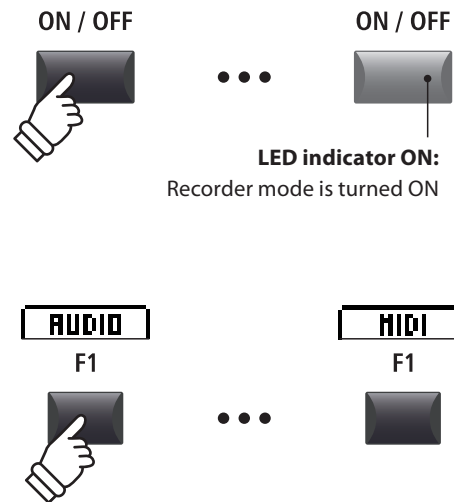

2. Selecting the song memory, adjusting tempo/beat

Turn control knob C to select the song memory to be used for the new recording.

* There are 10 internal song recorder memories.

* If the selected song memory already contains recording data, it will be erased automatically when the new song is recorded.

If recording with the metronome or a drum rhythm:

Turn control knobs B and D to adjust the tempo and beat (time signature) or drum rhythm used for the new recording.

* For more information about recording with the metronome or drum rhythms, please refer to page 90.

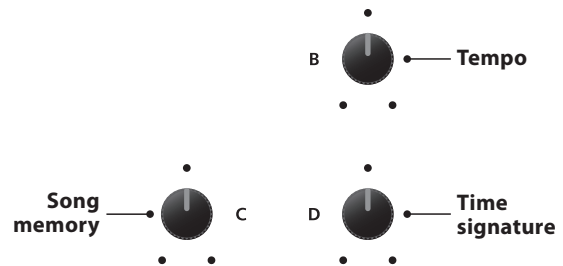

3. Starting the song recorder (standby mode)

Press the ● recorder control button.

The LED indicator for the ● button will start to flash, to indicate that the recorder is in standby mode.

* The F4 function button (REC) can also be used to engage standby mode.

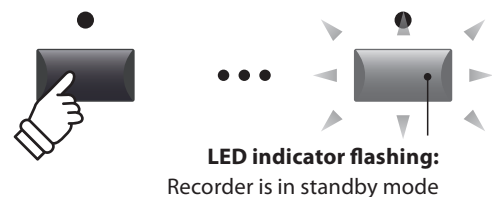

4. Starting the song recorder (recording)

Press a key on the keyboard.

The LED indicators for the ● and ▶/■ buttons will turn ON, the bar/beat counter shown in the centre of the LCD will begin to increase, and recording will start.

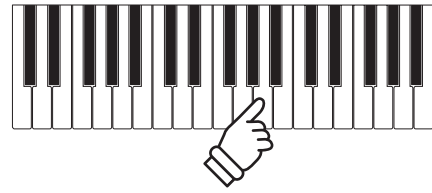
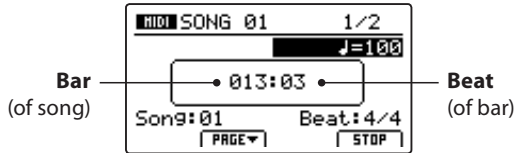

* Recording can also be started by pressing the ▶/■ button. This allows a rest period or empty bar to be inserted at the beginning of the song.

* The metronome can be enabled before recording to assist with timing etc. When enabled, a one bar count-in will be added before recording begins.

5. Stopping the song recorder

Press the ▶/■ recorder control button.

The LED indicators for the ● and ▶/■ buttons will turn OFF, and recording will stop.

* The F4 function button (STOP) can also be used to stop recording.

After a brief pause, the MIDI player screen will be shown in the LCD display.

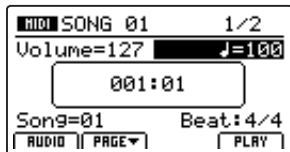

For information about playing the recorded song, please refer to page 66.

* The maximum recording capacity is approximately 90,000 notes, with button and pedal presses also counted as one note.

* If the maximum recording capacity is reached during recording, the recorder will stop automatically.

* To prevent data loss, avoid turning the power OFF while the MP11 is saving internal recorder songs.

* Recorder songs will remain in memory after the power is turned OFF.

2 Playing back a song

This function is used to playback recorder songs stored in internal memory. To playback a song immediately after recording, start this process from step 3.

1. Turning the Recorder mode ON

Press the RECORDER section's ON/OFF button to turn Recorder mode ON.

The LED indicator for the RECORDER section's ON/OFF button will turn ON, and the MIDI recorder screen will be shown in the LCD display.



If a USB memory device is connected, press the F1 button (MIDI) to select the MIDI recorder function.

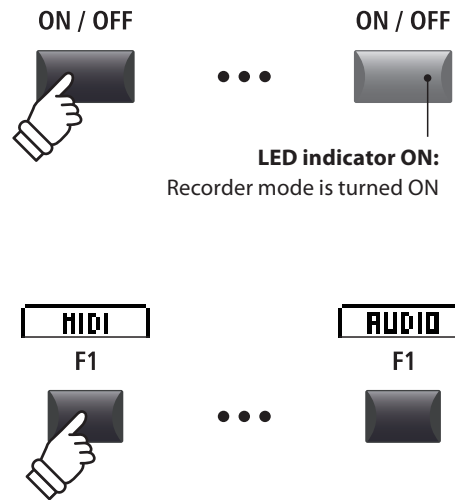

LED indicator ON:
Recorder mode is turned ON

2. Selecting the song to playback

Turn control knob C to select the song memory to be played back.

* Song selection is not possible during playback.



3. Starting song playback

Press the ►/■ recorder control button.

The LED indicator for the ►/■ button will turn ON, and the selected song will start to play.

* The F4 function button (PLAY) can also be used to start song playback.

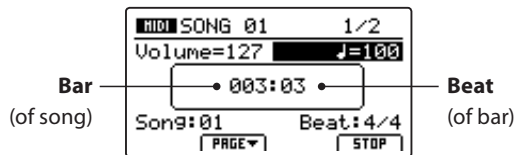

LED indicator ON:
Playback is in progress

■ Adjusting playback volume and tempo

Turn control knobs A and B to adjust the playback volume and tempo of the song.

* The playback volume and tempo of the song can be adjusted both before and during playback.



■ Moving the playback position (seek)

Press the ◀◀ or ▶▶ recorder control buttons to move the playing position of the song backward and forward in single bar increments.

* The playback position can be moved both before and during playback.

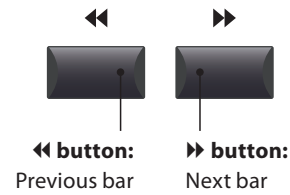

4. Stopping song playback

While a song is playing:

Press the ▶/■ recorder control button.

The LED indicator for the ▶/■ button will turn OFF, and song playback will stop.

* The F4 function button (STOP) can also be used to stop song playback.

Press the ▶/■ button again to continue playback from the stopped position, or the ◀◀ button to reset the playback position to the beginning of the song.

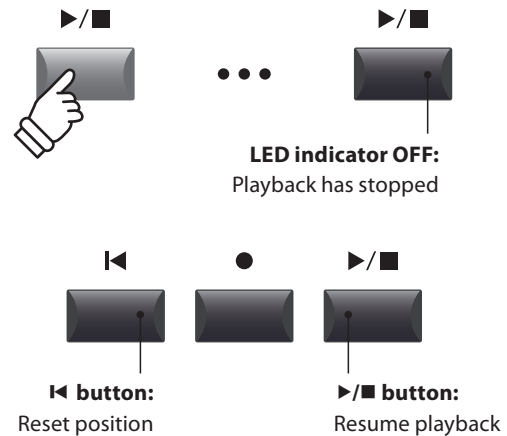

■ A-B Repeat function

The A-B Repeat function allows one section of a song to be repeated continuously (looped). This function can be activated both before and during song playback.

Press the A↔B recorder control button once to set the start point of the loop.

The LED indicator for the A↔B button will start to flash.

Press the A↔B button again to set the end point of the loop.

The LED indicator for the A↔B button will turn ON and the specified section will repeat continuously.

Press the A↔B button once again to cancel the loop.

The LED indicator for the A↔B button will turn OFF and normal playback will resume.

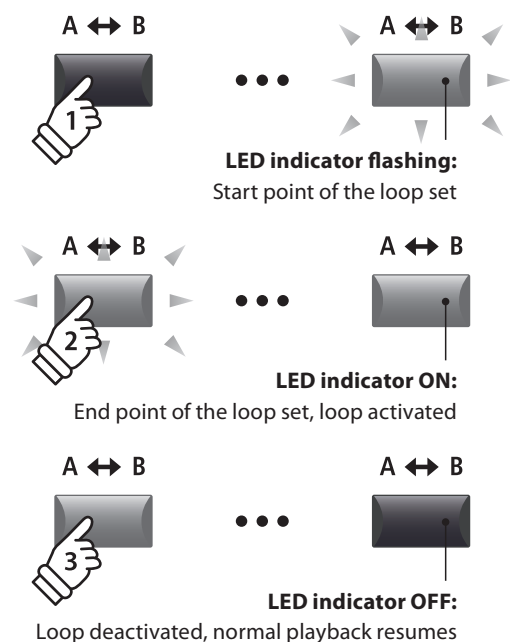

■ Chain Play mode

Chain Play mode allows all recorder songs stored in memory to be played continuously, in sequence.

Press and hold the ▶/■ recorder control button.

The Chain Play icon will be shown in the LCD display, and the recorder songs will start to play continuously, in sequence.



3 Saving a song as an SMF file

This function is used to save recorder songs to a USB memory device in SMF (Standard MIDI File) format.

1. Selecting the song memory

After turning Recorder mode ON, and recording a song:

Turn control knob C to select the song memory to be saved to the USB memory in SMF format.



2. Connecting a USB memory device

Connect a USB memory device to the USB to Device port.

* USB devices should be formatted to use the 'FAT' or 'FAT32' filesystems.

The USB device will be scanned, and the SAVE function will appear at the bottom of the LCD display.

* The SAVE function will appear only when the selected song memory has been recorded to.

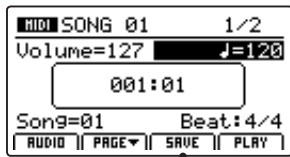

Save function

3. Selecting the Save SMF function

Press the F3 function button (SAVE).

The Save SMF screen will be shown in the LCD display.

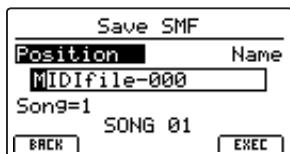
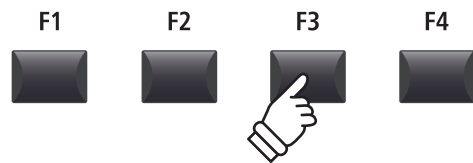

4. Entering a filename

Turn control knobs A and B to move the cursor position and select the characters for the song name.

* Saved SMF files are limited to a maximum name length of 18 characters.

* The saved SMF file will be stored in the root folder of the USB memory device. It is not possible to store the file in a different folder.

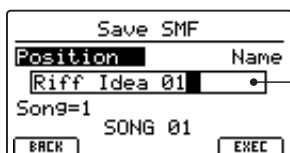

5. Saving the song

Press the F4 function button (EXEC).

The Save SMF confirmation screen will be shown in the LCD display.

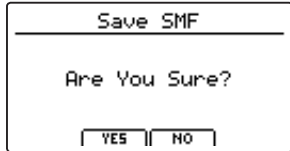

Press the F2 button (YES) to confirm the Save SMF operation, or the F3 button (NO) to return to the previous screen.

* The +/YES and -/NO buttons can also be used to confirm or cancel the save operation.

* To prevent data loss, avoid turning the power OFF while the MP11 is saving files to USB memory.

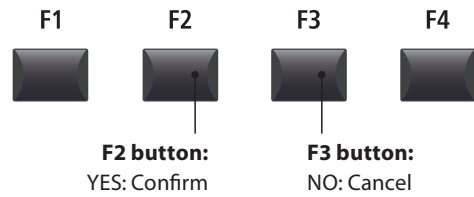

4 Loading an SMF file into memory

This function can be used to load SMF files into an empty recorder song memory.

■ Preparing the USB memory device

Prepare a selection of SMF MIDI files, copying the data to a USB memory device.



1. Selecting an empty song memory

After turning Recorder mode ON:

Turn control knob C to select an empty song memory.



2. Connecting a USB memory device

Connect a USB memory device to the USB to Device port.

* USB devices should be formatted to use the 'FAT' or 'FAT32' filesystems.

The USB device will be scanned, and the LOAD function will appear at the bottom of the LCD display.

* The LOAD function will appear only when the selected song memory is empty. For information about erasing song memories, please refer to page 72.

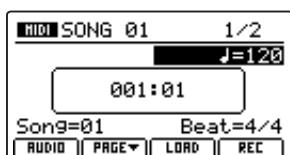

Load function

4 Loading an SMF file into memory (cont.)

3. Selecting the Load SMF function

Press the F3 function button (LOAD).

A listing of the SMF files stored in the root folder of the USB device will be shown in the LCD display.

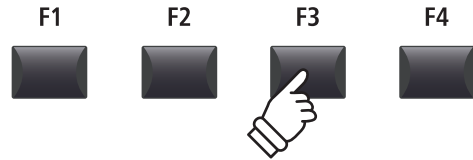

■ USB device file/folder listing screen

The MP11's file/folder listing screen lists relevant files and folders stored in the root of the USB device.

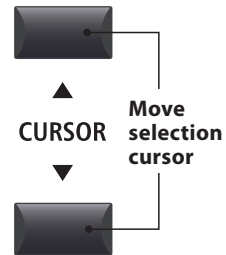
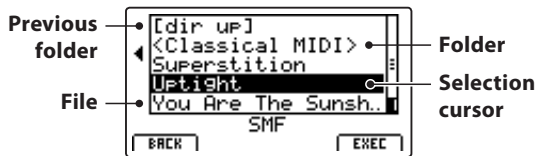

Press the CURSOR ▲▼ buttons to move the selection cursor.

* Control knob A can also be used to move the selection cursor.

Press the F4 function button (EXEC) or +/YES button to select the file or enter the selected folder.

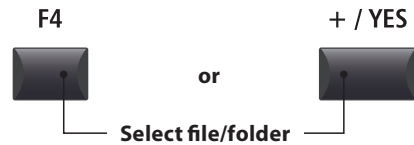

4. Selecting the SMF file to load

Press the CURSOR ▲▼ buttons to select the desired MIDI file.

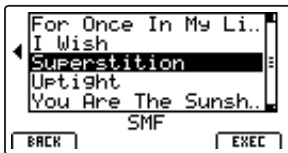

Press the F4 function button (EXEC) or +/YES button.

The Load SMF screen will be shown in the LCD display.

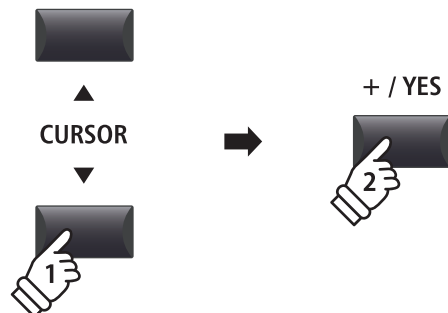
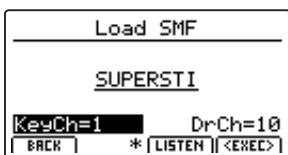

5. Selecting the keyboard and drum channels

Turn control knobs C and D to specify which channels of the SMF file should be loaded into the MP11 recorder's keyboard and drum tracks.

* The MP11 will attempt to detect the correct keyboard and drum tracks automatically, based on the contents of the SMF file.

* When loading an SMF file created by the MP11, the drum track will be turned OFF.

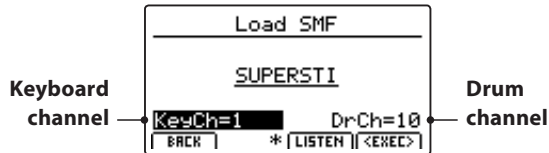

Press the F3 function button (LISTEN) to audition the current channel settings.

Press the F4 function button (EXEC) to load the selected SMF file into the song memory.

The Load SMF confirmation screen will be shown in the LCD display.

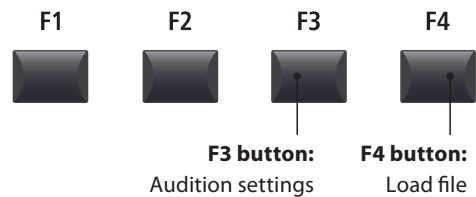

6. Confirming the Load SMF operation

Press the F2 button (YES) to confirm the Load SMF operation, or the F3 (NO) button to return to the previous screen.

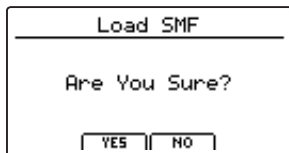

* The +/-YES and +/-NO buttons can also be used to confirm or cancel the load SMF operation.

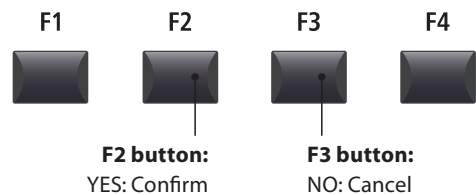

7. Playing the loaded SMF file

After loading the SMF file, the recorder screen will be shown in the LCD display.

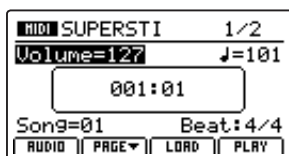

For information about playing the loaded MIDI file, please refer to page 66.

5 Erasing a song

This function is used to erase songs that have been recorded incorrectly, or are simply no longer required.

1. Selecting the song to erase

After turning Recorder mode ON and recording a song:

Turn control knob C to select the song memory to be erased.



* To erase all recorder songs, use the Reset Recorder function in the Reset category of the SYSTEM menu (page 108).

2. Showing the additional recorder functions

Press the F2 function button (PAGE▼).

An additional page of recorder functions will be shown in the LCD display.

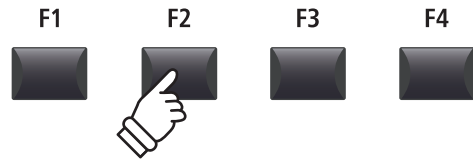
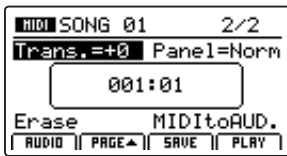

* The CURSOR ▲▼ buttons can also be used to alternate between pages.

3. Selecting the Erase Song function

Turn control knob C to highlight the Erase Song function.

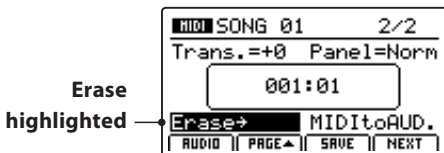

* The CURSOR buttons can also be used to move the selection cursor.

Press the +/YES button to select the Erase Song function.

The Erase Song confirmation screen will be shown in the LCD display.



* It is also possible to select the Erase Song function at any time by pressing the ● and ►/■ recorder control buttons simultaneously.

4. Confirming the Erase Song operation

Press the F2 button (YES) to confirm the Erase Song operation, or the F3 (NO) button to return to the previous screen.

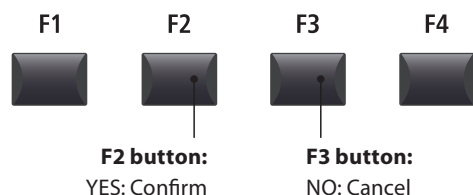
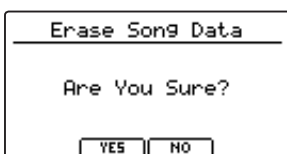

* The +/YES and -/NO buttons can also be used to confirm or cancel the Erase Song operation.

6 Song Transpose

This parameter allows the playback pitch of songs stored in memory to be raised or lowered in semi-tone steps. This may be useful when wishing to transpose a loaded SMF file into another key.

■ Changing the song transpose value

Press the F2 function button (PAGE▼) to show the second page of recorder functions.

Turn control knob A to change the song transpose value.

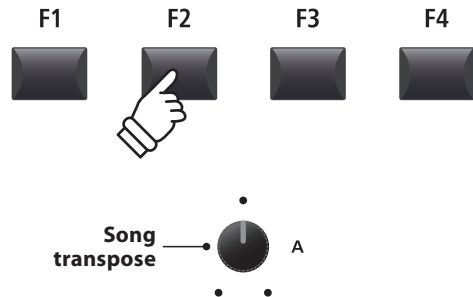

* The Song Transpose value can be adjusted within the range of -12 ~ +12.

7 Panel Mode

This parameter determines whether or not changes made to the panel during recording will be replicated when a song is played back, thus influencing the current keyboard settings.

■ Panel Mode types

Panel Mode	Description
Normal (default)	Panel settings will not change during song playback, and will not influence the current keyboard settings.
Play	Panel settings will change during song playback, and will also influence the current keyboard settings.

	Normal panel mode	Play panel mode
Advantages	Keyboard settings are independent of recorder song.	All functions (including EFX) are played back perfectly.
Disadvantages	Some functions (e.g. EFX) are not played back perfectly.	Keyboard settings are dependent on recorder song.

■ Changing the panel mode type

Press the F2 function button (PAGE▼) to show the second page of recorder functions.

Turn control knob B to change the panel mode type.

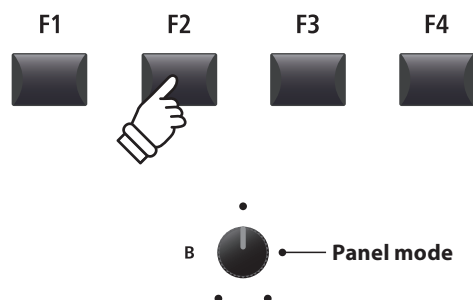
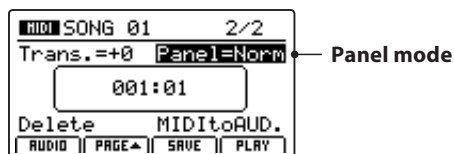

8 MIDI to Audio

For information about the MIDI to Audio function, please refer to page 83.

Audio Record/Playback (USB Memory)

1 Recording an audio file

The MP11 is also capable of recording performances (including LINE IN input audio) as digital audio – saving the data to a USB memory device in either MP3 or WAV format. This useful function allows professional quality recordings to be produced directly on the instrument – without the need for additional sound equipment – then emailed to band members, listened to away from the instrument, or edited and remixed further using an audio workstation.

■ Audio Recorder format specifications

Audio Format	Specifications	Bitrate
MP3	44.1 kHz, 16 bit, Stereo	192 kbit/s (fixed)
WAV	44.1 kHz, 16 bit, Stereo	1,411 kbit/s (uncompressed)

* MPEG Layer-3 audio coding technology licensed from Fraunhofer IIS and Thomson.
MP3 codec is Copyright (c) 1995-2007, SPIRIT

1. Connecting a USB memory device

Connect a USB memory device to the USB to Device port.

* USB devices should be formatted to use the 'FAT' or 'FAT32' filesystems.

The USB device will be scanned.



2. Turning the Recorder mode ON

Press the RECORDER section's ON/OFF button to turn Recorder mode ON.

The LED indicator for the RECORDER section's ON/OFF button will turn ON, and the Audio recorder screen will be shown in the LCD display.

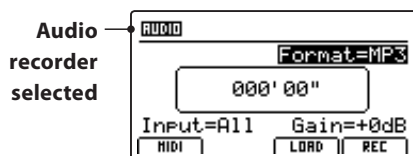
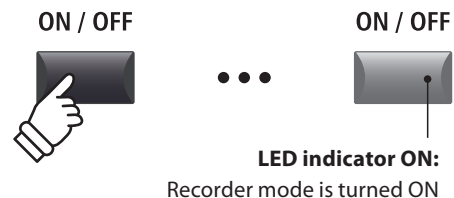

* If the MIDI recorder screen is shown, press the F1 function button (AUDIO) to select the Audio recorder.

■ Selecting the audio recorder file format

Turn control knob B to select the desired audio recorder format.

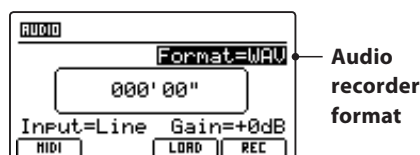

* MP3 audio files require less storage space than WAV audio files.

* A 1 GB USB memory device can store over 12 hours of MP3 audio data.

■ Selecting the audio recorder input, adjusting gain level

Turn control knob C to select the desired audio recorder input.

Turn control knob D to adjust the gain level of the recorder.

Increasing the audio recorder gain level parameter may be useful when recording quieter passages.

Input	Description
All	Record the keyboard sound and the LINE IN sound.
Line	Record the LINE IN sound only.

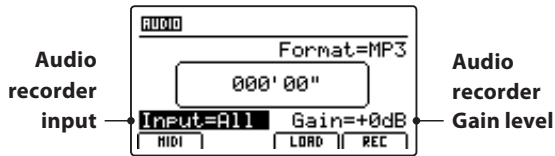

* The gain level can be set within the range of -18 dB ~ +18 dB.

3. Starting the audio recorder (standby)

Press the ● recorder control button.

The LED indicator for the ● button will start to flash, to indicate that the recorder is in standby mode.

- * The F4 function button (REC) can also be used to engage standby mode.
- * Depending on the USB memory device connected, there may be a brief delay before standby mode is engaged.

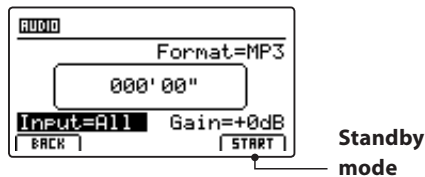
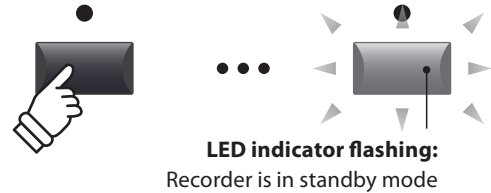

4. Starting the audio recorder (record)

Press a key on the keyboard.

The LED indicators for the ● and ►/■ buttons will turn ON, the time counter shown in the centre of the LCD will begin to increase, and recording will start.

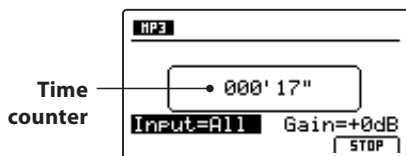
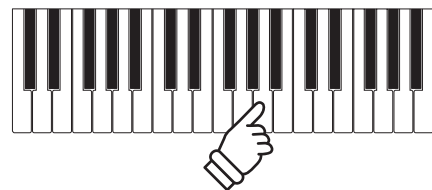

- * Recording can also be started by pressing the ►/■ button. This allows a rest period or empty bar to be inserted at the beginning of the song.
- * The metronome can be enabled before recording to assist with timing etc. When enabled, a one bar count-in will be added before recording begins.

5. Stopping the audio recorder, auditioning the recording

Press the ▶/■ recorder control button.

The LED indicators for the ● and ▶/■ buttons will turn OFF, and recording will stop.

* The F4 function button (STOP) can also be used to stop recording.

After a brief pause, the Audio player screen will be shown in the LCD display.



* Press the ● and ▶/■ recorder control buttons simultaneously to erase the recorded audio file from memory.

Press the F4 function button (PLAY) to audition the recording before saving.



6. Selecting the save function, entering the audio file name

Press the F3 function button (SAVE).

The save audio screen will be shown in the LCD display.

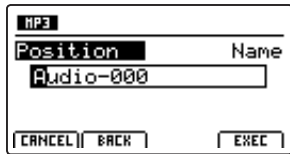

Turn control knobs A and B to move the cursor position and select the characters for the audio file name.

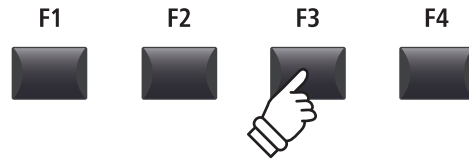
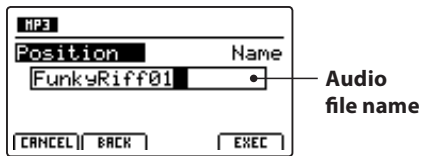

* Saved audio files are limited to a maximum name length of 18 characters.
* The saved audio file will be stored in the root folder of the USB memory device. It is not possible to store the file in a different folder.

7. Saving the audio file

Press the F4 function button (EXEC).

The save audio confirmation screen will be shown in the LCD display.

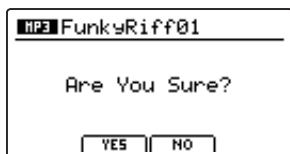

Press the F2 button (YES) to confirm the save audio operation, or the F3 button (NO) to return to the previous screen.

* The +/YES and -/NO buttons can also be used to confirm or cancel the save operation.

* To prevent data loss, avoid turning the power OFF while the MP11 is saving files to USB memory.

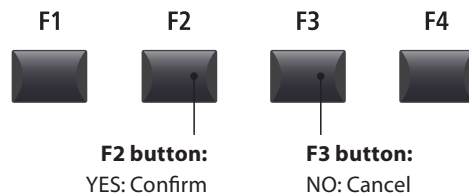

2 Playing an audio file

The MP11 is also capable of playing MP3 and WAV audio files stored on a USB memory device. This function allows performing musicians to play along with professional backing tracks, or conveniently learn the chords or melody for a new piece.

■ Audio Player supported format specifications

Audio Format	Specifications	Bitrate
MP3	32 kHz/44.1 kHz/48 kHz, Mono/Stereo	8-320 kbit/s (fixed & variable)
WAV	32 kHz/44.1 kHz/48 kHz, Mono/Stereo, 8 bit/16 bit	-

* MPEG Layer-3 audio coding technology licensed from Fraunhofer IIS and Thomson.
MP3 codec is Copyright (c) 1995-2007, SPIRIT

■ Preparing the USB memory device

Prepare a selection of MP3 or WAV audio files, copying the data to a USB memory device.

* USB devices should be formatted to use the 'FAT' or 'FAT32' filesystems.



1. Connecting a USB memory device

Connect the USB memory device to the USB to Device port.

The USB device will be scanned.



2. Turning the Recorder mode ON

Press the RECORDER section's ON/OFF button to turn Recorder mode ON.

The LED indicator for the RECORDER section's ON/OFF button will turn ON, and the Audio recorder screen will be shown in the LCD display.

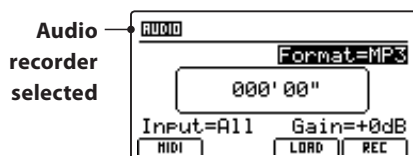
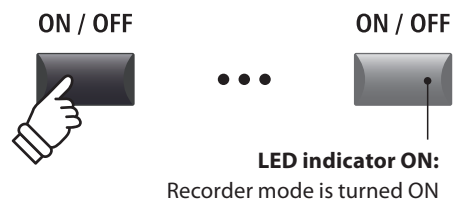

* If the MIDI recorder screen is shown, press the F1 function button (AUDIO) to select the Audio recorder.

3. Selecting the Load Audio function

Press the F3 function button (LOAD).

A listing of the MP3 files stored in the root folder of the USB device will be shown in the LCD display.

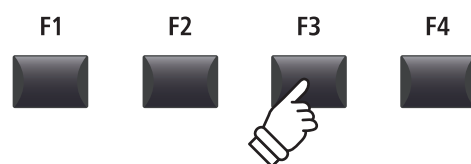

2 Playing an audio file (cont.)

■ USB device file/folder listing screen

The MP11's file/folder listing screen lists relevant files and folders stored in the root of the USB device.



Press the CURSOR ▲▼ buttons to move the selection cursor.

* Control knob A can also be used to move the selection cursor.

Press the F3 or F2 function buttons to alternate between showing WAV or MP3 format audio files.

* By default, MP3 files will be shown.

Press the F4 function button (EXEC) or +/YES button to select the file or enter the selected folder.

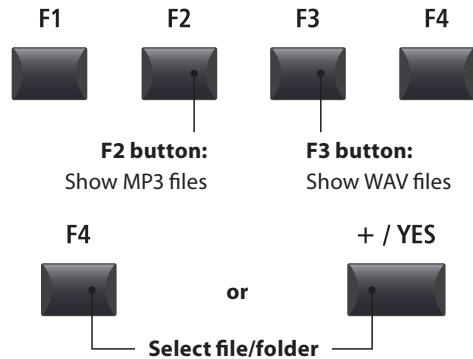
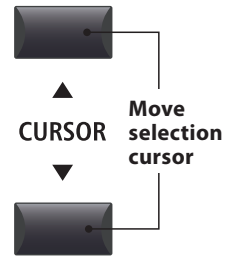

4. Selecting the audio file to load

Press the CURSOR ▲▼ buttons to select the desired audio file.

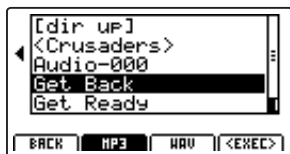

Press the F4 function button (EXEC) or +/YES button.

The audio player screen will be shown in the LCD display.

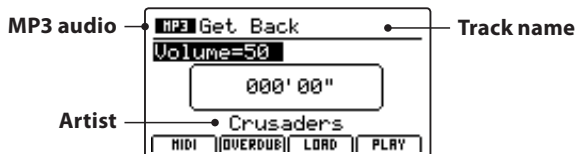

* If available, the audio file's metadata (ID3 tags etc.) will also be shown.

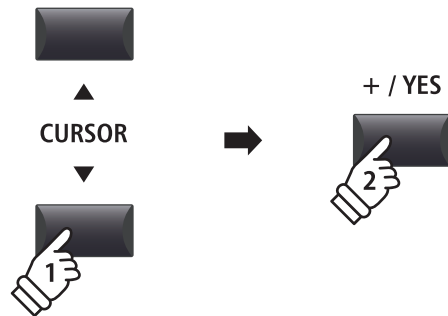

5. Starting audio file playback

Press the ►/■ recorder control button.

The LED indicator for the ►/■ button will turn ON, and the selected song will start to play.

* The F4 function button (PLAY) can also be used to start song playback.



■ Moving the playback position (seek)

Press the ◀◀ or ▶▶ recorder control buttons to rewind or fast-forward the playing position of the audio file.

* The playback position can be moved both before and during playback.

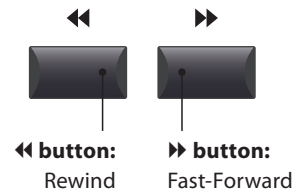

6. Stopping audio file playback

While an audio file is playing:

Press the ▶/■ recorder control button.

The LED indicator for the ▶/■ button will turn OFF, and audio file playback will stop.

Press the ▶/■ button again to continue playback from the stopped position, or the ◀ button to reset the playback position to the beginning of the audio file.

* The F4 function button (STOP) can also be used to reset audio playback.

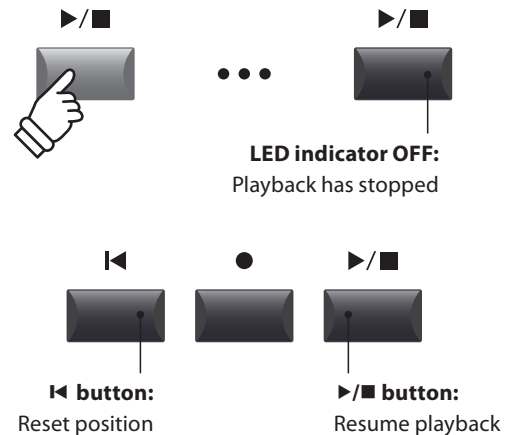

■ A-B Repeat function

The A-B Repeat function allows one section of an audio file to be repeated continuously (looped). This function can be activated both before and during audio file playback.

Press the A↔B recorder control button once to set the start point of the loop.

The LED indicator for the A↔B button will start to flash.

Press the A↔B button again to set the end point of the loop.

The LED indicator for the A↔B button will turn ON and the specified section will repeat continuously.

Press the A↔B button once again to cancel the loop.

The LED indicator for the A↔B button will turn OFF and normal playback will resume.

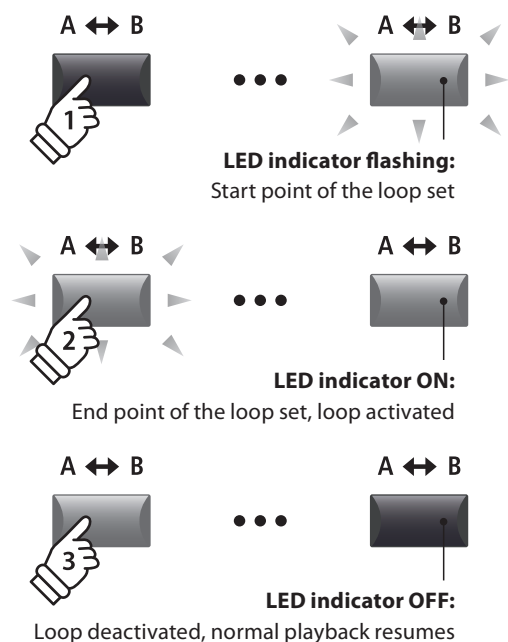

■ Chain Play mode

Chain Play mode allows all audio files stored in a folder to be played continuously, in sequence.

Press and hold the ▶/■ recorder control button.

The Chain Play icon will be shown in the LCD display, and the audio files will start to play continuously, in sequence.



3 Overdubbing an audio file

The overdub function adds supplementary recording(s) to an existing audio file, facilitating simple multi-track recordings to be produced directly on the instrument.

Each overdub is recorded to a temporary file (i.e. the original audio file is not modified), allowing an unlimited number of overdubs that to be made before eventually saving the final recording.

1. Connecting a USB memory device

Connect the USB memory device to the USB to Device port.

The USB device will be scanned.



2. Turning the Recorder mode ON

Press the RECORDER section's ON/OFF button to turn Recorder mode ON.

The LED indicator for the RECORDER section's ON/OFF button will turn ON, and the Audio recorder screen will be shown in the LCD display.

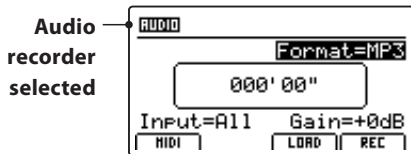
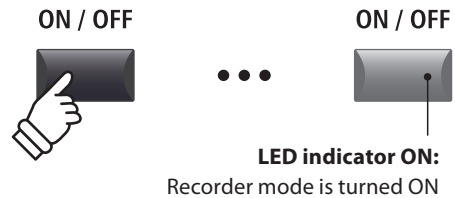

* If the MIDI recorder screen is shown, press the F1 function button (AUDIO) to select the Audio recorder.

3. Selecting the Load Audio function

Press the F3 function button (LOAD).

A listing of the MP3 files stored in the root folder of the USB device will be shown in the LCD display.

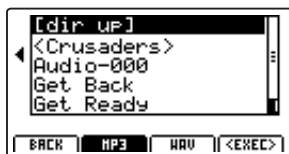
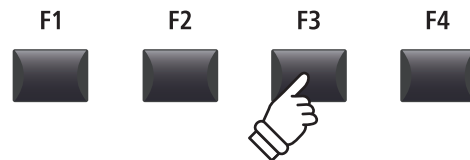

4. Selecting the audio file to load

Press the CURSOR ▲▼ buttons to select the desired audio file.



Press the F4 function button (EXEC) or +/YES button.

The audio player screen will be shown in the LCD display.

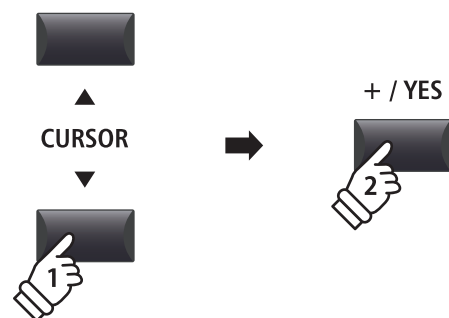

5. Selecting the overdub function and file format

Press the F2 function button (OVERDUB).

The overdub file format selection screen will be shown in the LCD display.

Turn control knob B to select the desired overdub file format, and control knob A to adjust the volume of the source audio.

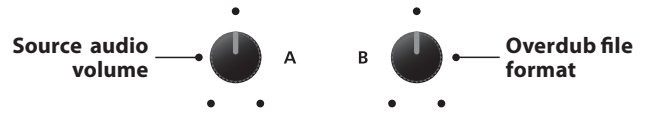
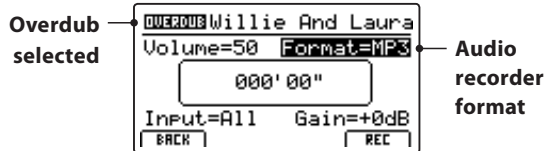
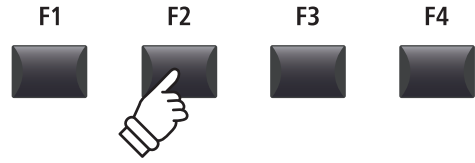

- * MP3 audio files require less storage space than WAV audio files.
- * A 1 GB USB memory device can store over 12 hours of MP3 audio data.

Selecting the audio recorder input, adjusting gain level

Turn control knob C to select the desired audio recorder input.

Turn control knob D to adjust the gain level of the overdub.

Increasing the audio recorder gain level parameter may be useful when recording quieter passages.

Input	Description
All	Record the keyboard sound and the LINE IN sound.
Line	Record the LINE IN sound only.

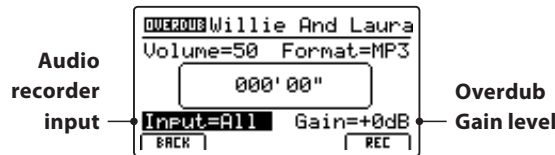

- * The gain level can be set within the range of -18 dB ~ +18 dB.

6. Starting the overdub (standby)

Press the ● recorder control button.

The LED indicator for the ● button will start to flash, to indicate that the recorder is in standby mode.

- * The F4 function button (REC) can also be used to engage standby mode.
- * Depending on the USB memory device connected, there may be a brief delay before standby mode is engaged.

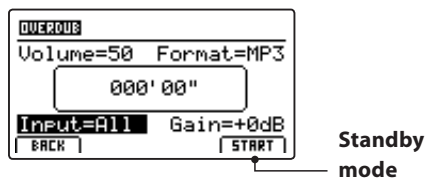
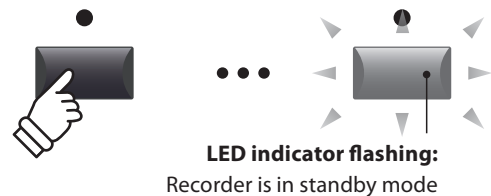

7. Starting the overdub (record)

Press a key on the keyboard.

The LED indicators for the ● and ▶/■ buttons will turn ON, the time counter shown in the centre of the LCD will be to increase, and overdubbing will start.

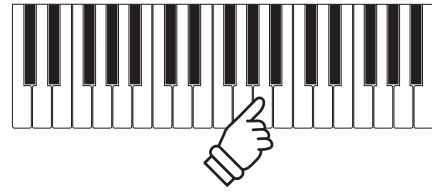
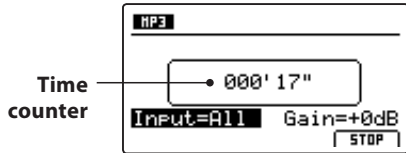

- * Overdubbing can also be started by pressing the ▶/■ button. This allows a rest period or empty bar to be inserted at the beginning of the song.
- * The metronome can be enabled before overdubbing to assist with timing etc. When enabled, a one bar count-in will be added before overdubbing begins.

8. Stopping and auditioning the overdub

Press the ▶/■ recorder control button.

The LED indicators for the ● and ▶/■ buttons will turn OFF, and overdubbing will stop.

- * The F4 function button (STOP) can also be used to stop overdubbing.

After a brief pause, the Audio player screen will be shown in the LCD display.



- * Press the ● and ▶/■ recorder control buttons simultaneously to erase the overdubbed audio file from memory.

Press the F4 function button (PLAY) to audition the overdub before saving.



9. Selecting the save function, entering the audio file name

Press the F3 function button (SAVE).

The save audio screen will be shown in the LCD display.

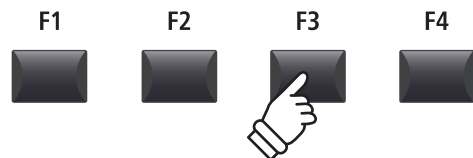
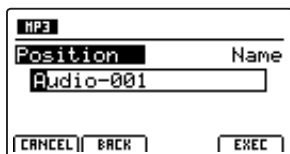

Turn control knobs A and B to move the cursor position and select the characters for the audio file name.

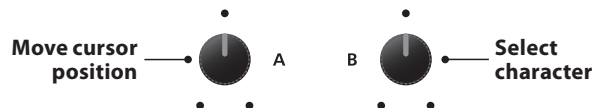
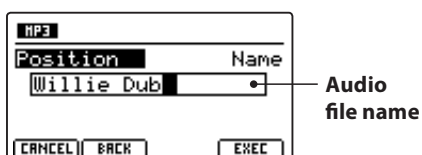

- * Saved audio files are limited to a maximum name length of 18 characters.
- * The saved audio file will be stored in the root folder of the USB memory device. It is not possible to store the file in a different folder.

10. Saving the dubbed file

Press the F4 function button (EXEC).

The save audio confirmation screen will be shown in the LCD display.

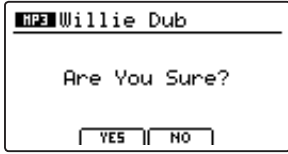

Press the F2 button (YES) to confirm the save audio operation, or the F3 button (NO) to return to the previous screen.

* The +/YES and -/NO buttons can also be used to confirm or cancel the save operation.

* To prevent data loss, avoid turning the power OFF while the MP11 is saving files to USB memory.

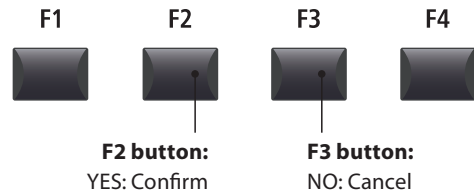

4 Converting a recorder song to an audio file

This function allows recorder songs stored in internal memory to be played back and saved (converted) as an audio file to a USB device in either MP3 or WAV format.

1. Connecting a USB memory device

Connect the USB memory device to the USB to Device port.

* USB devices should be formatted to use the 'FAT' or 'FAT32' filesystems.

The USB device will be scanned.



2. Selecting the MIDI to Audio function

After selecting the MIDI recorder and recording a song:

Press the F2 function button (PAGE▼) to show the additional MIDI recorder functions.

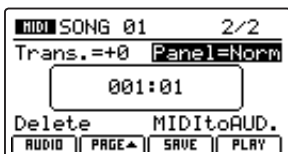

Turn control knob D to highlight the MIDI to Audio function.

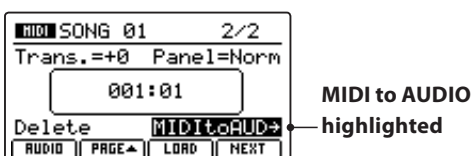

* The CURSOR buttons can also be used to move the selection cursor.

Press the +/YES button to select the MIDI to Audio function.

The MIDI to Audio screen will be shown in the LCD display.

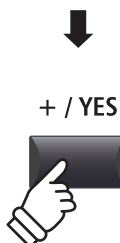
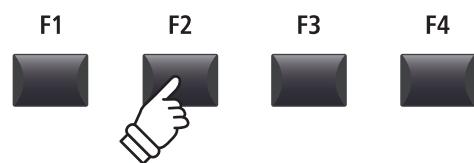

4 Converting a recorder song to an audio file (cont.)

3. Selecting the MIDI to Audio file format

Turn control knob B to select the desired MIDI to Audio file format, and control knob A to adjust the volume of the song playback.

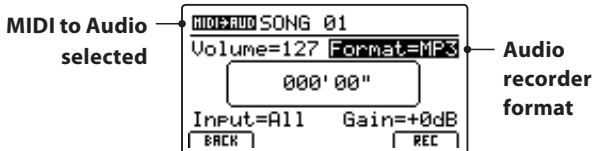
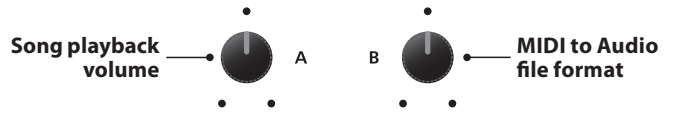

- * MP3 audio files require less storage space than WAV audio files.
- * A 1 GB USB memory device can store over 12 hours of MP3 audio data.

Selecting the audio recorder input, adjusting gain level

Turn control knob C to select the desired audio recorder input.

Turn control knob D to adjust the gain level of the MIDI to Audio conversion/recording.

Input	Description
All	Record the keyboard sound and the LINE IN sound.
Line	Record the LINE IN sound only.

Increasing the audio recorder gain level parameter may be useful when recording quieter passages.

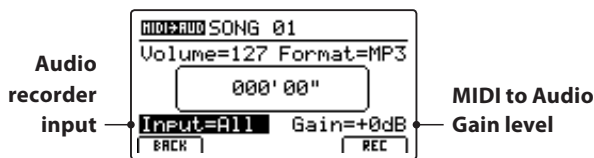

- * The gain level can be set within the range of -18 dB ~ +18 dB.

4. Starting the conversion (standby)

Press the ● recorder control button.

The LED indicator for the ● button will start to flash, to indicate that the recorder is in standby mode.

- * The F4 function button (REC) can also be used to engage standby mode.
- * Depending on the USB memory device connected, there may be a brief delay before standby mode is engaged.

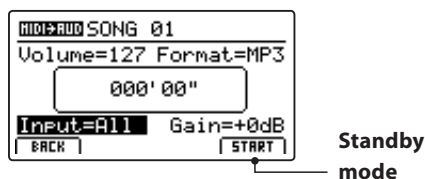
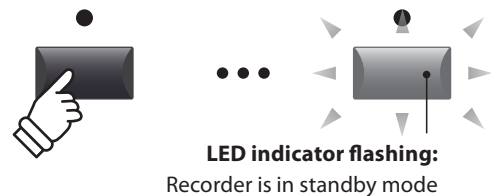

5. Starting the conversion (record)

Press the ▶/■ recorder control button.

The LED indicators for the ● and ▶/■ buttons will turn ON, the time counter shown in the centre of the LCD will begin to increase, and the conversion will start.

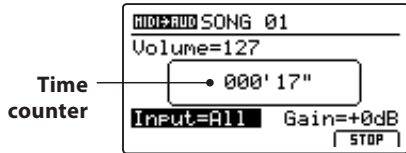

Conversion will stop automatically when the end of the recorder song is reached.

* The ▶/■ button or F4 function button (STOP) can also be used to stop the conversion before the end of the song.

The LED indicators for the ● and ▶/■ buttons will turn OFF, and the conversion will stop.

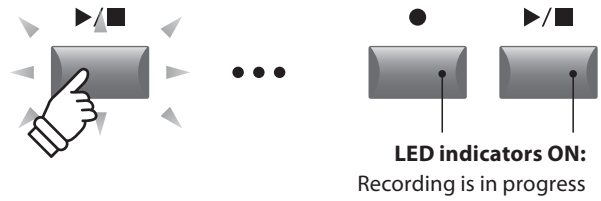

* Conversion can also be started by pressing the F4 function button (START).

* Notes played on the keyboard will also be recorded to the audio file..

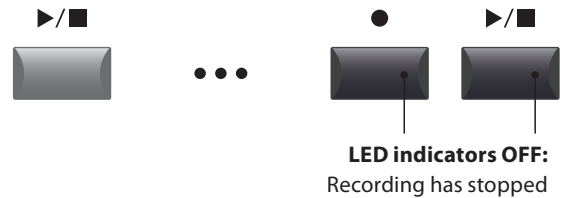

6. Selecting the save function, entering the audio file name

Press the F3 function button (SAVE).

The save audio screen will be shown in the LCD display.

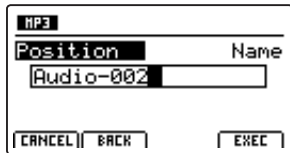

Turn control knobs A and B to move the cursor position and select the characters for the audio file name.

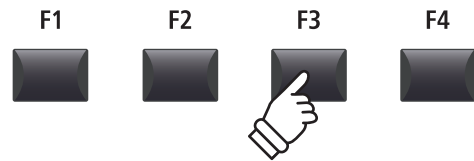
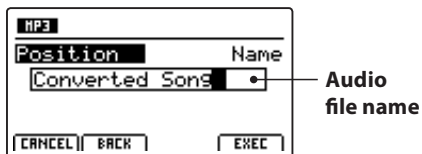

* Saved audio files are limited to a maximum name length of 18 characters.

* The saved audio file will be stored in the root folder of the USB memory device. It is not possible to store the file in a different folder.

7. Saving the converted audio file

Press the F4 function button (EXEC).

The save confirmation screen will be shown in the LCD display.

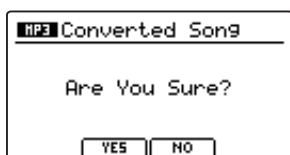

Press the F2 button (YES) to confirm the save audio operation, or the F3 button (NO) to return to the previous screen.

* The +/YES and -/NO buttons can also be used to confirm or cancel the save operation.

* To prevent data loss, avoid turning the power OFF while the MP11 is saving files to USB memory.

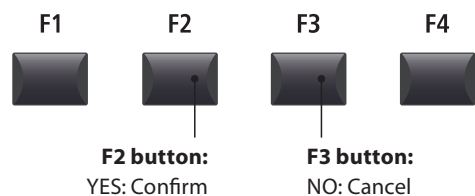

Metronome

The Metronome function provides a steady beat to aid practicing the piano at a consistent tempo. In addition to regular metronome beats in various time signatures, the MP11 also features a selection of drum rhythms to accompany most playing styles and musical genres.

1 Click mode

In Click mode, the metronome function provides a simple click track in a number of different time signatures.

■ Activating the metronome function

Press the METRONOME button.

The LED indicator for the METRONOME button will turn ON to indicate that the metronome function is in use, and the Metronome screen will be shown in the LCD display.

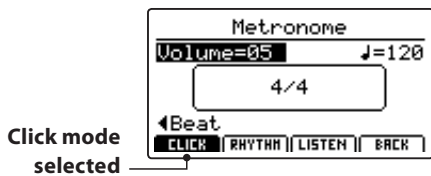
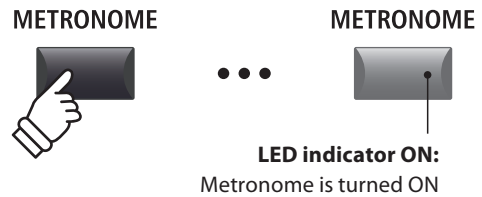

* The metronome will be set to Click mode by default.

■ Starting and Stopping the metronome

Press the F3 function button (LISTEN)

The LISTEN icon will become highlighted and the metronome will start counting a 4/4 beat at 120 bpm (beats per minute).

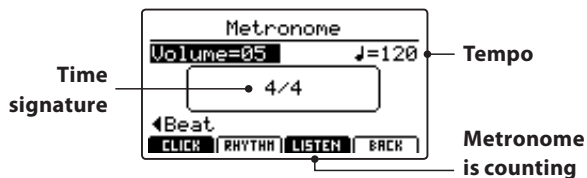
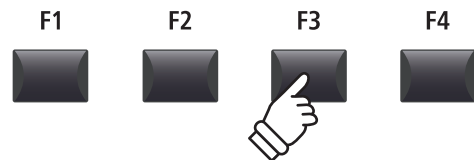

Press the F3 function button again to stop the metronome.

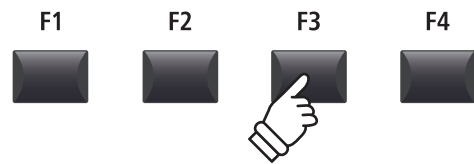

■ Adjusting the Metronome volume, tempo, and time signature (beat)

Turn control knobs A and B to adjust the metronome volume and tempo, and knob C to change the time signature (beat).

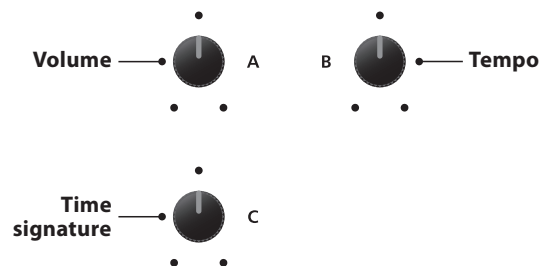
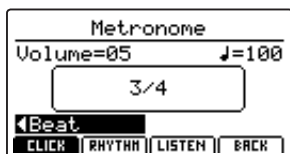

* The metronome tempo can be adjusted within the range of 30-300 bpm (60-600 bpm for eighth note time signatures).

* There are ten different types of beat/time signature available: 1/4, 2/4, 3/4, 4/4, 5/4, 3/8, 6/8, 7/8, 9/8, and 12/8.

* Preferred metronome settings can be saved to a SETUP or POWERON memory for immediate recall.

■ Returning to the previous screen (BACK function)

While the metronome is counting:

Press the F4 function button (BACK) to return to the previous screen without stopping or deactivating the metronome.

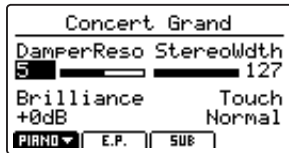

Press and hold the METRONOME button again to show the Metronome screen in the LCD display.

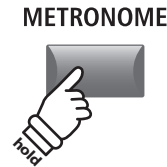

2 Rhythm mode

In Rhythm mode, the metronome function provides a more musically inspiring drum track. There are 100 different drum patterns available, grouped into 13 categories.

* For a full listing of available drum patterns, please refer to page 89.

■ Activating the metronome function

Press the METRONOME button.

The LED indicator for the METRONOME button will turn ON to indicate that the metronome function is in use, and the Metronome screen will be shown in the LCD display.

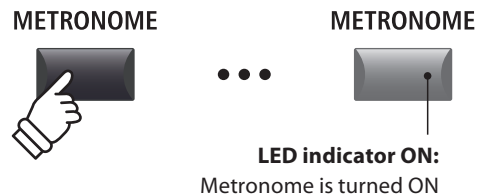
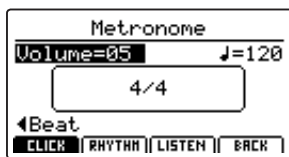

* The metronome will be set to Click mode by default.

■ Selecting Rhythm mode

Press the F2 function button (RHYTHM)

The RHYTHM icon will become highlighted, and the currently selected drum rhythm category and variation will be shown in the LCD display.

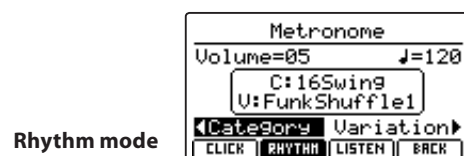
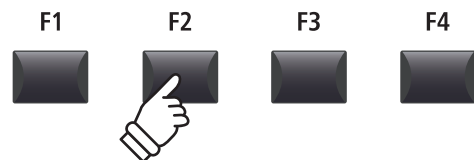

Rhythm mode selected

2 Rhythm mode (cont.)

Starting and Stopping the drum rhythm

Press the F3 function button (LISTEN)

The LISTEN icon will become highlighted and the currently selected drum rhythm category and variation will start to play.

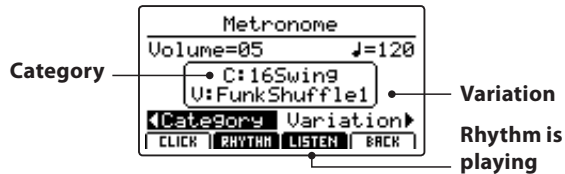

Press the F3 function button again to stop the drum rhythm.

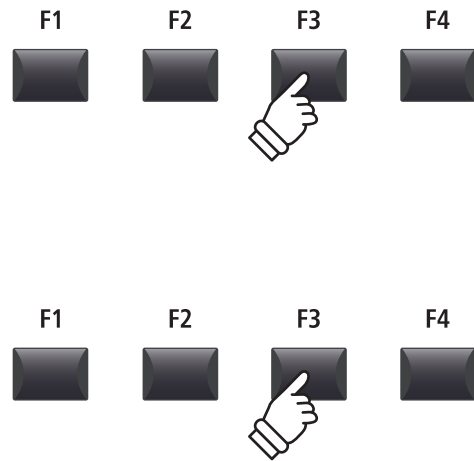

Adjusting the drum rhythm volume, tempo, category, and variation

Turn control knobs A and B to adjust the drum rhythm volume and tempo.

Turn control knobs C and D to select the drum rhythm category and variation.

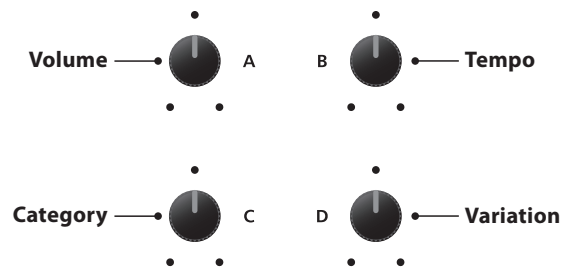

* Preferred drum rhythm settings can be saved to a SETUP or POWERON memory for immediate recall.

* The metronome tempo can be adjusted within the range of 30-300 bpm.

* For a full listing of available drum patterns, please refer to page 89.

Returning to the previous screen (BACK function)

While the drum rhythm is playing:

Press the F4 function button (BACK) to return to the previous screen without stopping or deactivating the metronome.

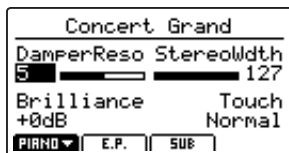

Press and hold the METRONOME button again to show the Metronome screen in the LCD display.

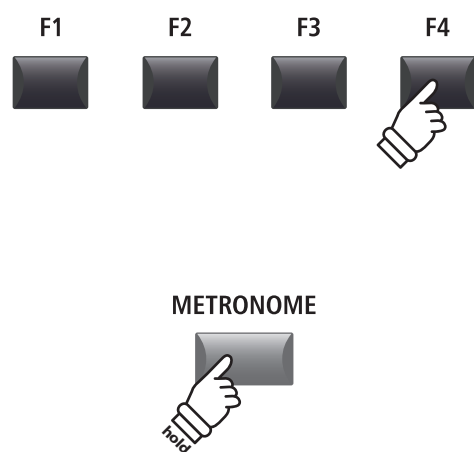

■ Drum rhythm categories and variations

16 Swing	
1	Funk Shuffle 1
2	Funk Shuffle 2
3	Hip Hop 1
4	Hip Hop 2
5	Hip Hop 3
6	Hip Hop 4
7	16 Shuffle 1
8	16 Shuffle 2
9	16 Shuffle 3

16 Funk	
10	Funky Beat 1
11	Funky Beat 2
12	Funky Beat 3
13	Funk 1
14	Funk 2
15	Funk 3

16 Straight	
16	Jazz Funk
17	16 Beat 1
18	16 Beat 2
19	16 Beat 3
20	16 Beat 4
21	Ride Beat 4
22	Rim Beat
23	Roll Beat
24	Light Ride 1
25	Dixie Rock

16 Latin	
26	Surdo Samba
27	Latin Groove
28	Light Samba
29	Songo
30	Samba
31	Merenge

16 Dance	
32	Funky Beat 4
33	16 Beat 5
34	Disco 1
35	Disco 2
36	Techno 1
37	Techno 2
38	Techno 3
39	Heavy Techno

16 Ballad	
40	Ballad 1
41	Ballad 2
42	Ballad 3
43	Ballad 4
44	Ballad 5
45	Light Ride 2
46	Electro Pop 1
47	Electro Pop 2
48	16 Shuffle 4

8 Ballad	
49	Slow Jam
50	50's Triplet
51	R&B Triplet

8 Straight	
52	8 Beat 1
53	8 Beat 2
54	Smooth Beat
55	Pop 1
56	Pop 2
57	Ride Beat 1
58	Ride Beat 2
59	Ride Beat 3
60	Slip Beat

8 Rock	
61	Jazz Rock
62	8 Beat 3
63	Rock Beat 1
64	Rock Beat 2
65	Rock Beat 3
66	Rock Beat 4
67	Blues/Rock
68	Heavy Beat
69	Hard Rock
70	Surf Rock
71	R&B

8 Swing	
72	Motown 1
73	Fast Shuffle
74	Motown 2
75	Country 2 Beat

Triplet	
76	Triplet Rock 1
77	Triplet Rock 2
78	Bembe
79	Rock Shuffle 1
80	Rock Shuffle 2
81	Boogie
82	Triplet 1
83	Triplet 2
84	Reggae
85	Gospel Ballad
86	Waltz

Jazz	
87	H.H. Swing
88	Ride Swing
89	Fast 4 Beat
90	Afro Cuban
91	Jazz Waltz 1
92	Jazz Waltz 2
93	5/4 Swing

8 Latin	
94	H.H. Bossa
95	Ride Bossa
96	Beguine
97	Mambo
98	Cha Cha
99	Tango
100	Habanera

3 Recording with the metronome

Recording with the metronome is a convenient way to maintain consistent timing and rhythm while playing. This is especially important when integrating recordings into a sequencer or DAW.

The explanation below uses the internal song recorder as an example, however the procedure for recording with the metronome to an MP3/WAV audio file is identical.

1. Turning the Recorder mode ON

Press the RECORDER section's ON/OFF button to turn Recorder mode ON.

The LED indicator for the RECORDER section's ON/OFF button will turn ON, and the MIDI recorder screen will be shown in the LCD display.

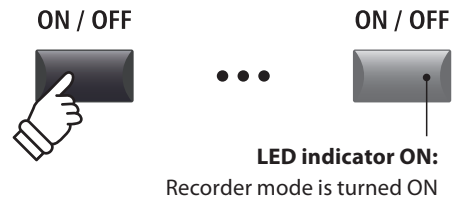

2. Activating the metronome function

Press the METRONOME button.

The LED indicator for the METRONOME button will turn ON to indicate that the metronome function is in use, and the Metronome screen will be shown in the LCD display.

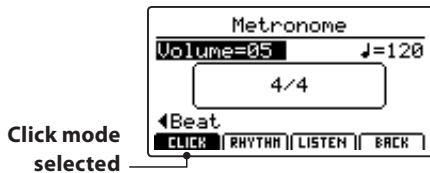
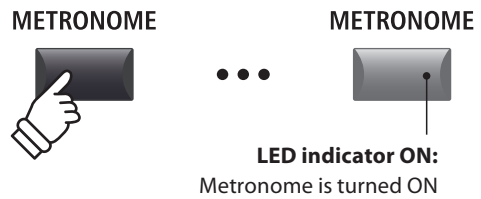

3. Adjusting the Metronome volume, tempo, and time signature (beat)

Turn control knobs A and B to adjust the metronome volume and tempo, and knob C to change the time signature (beat).

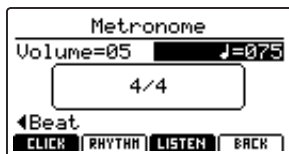
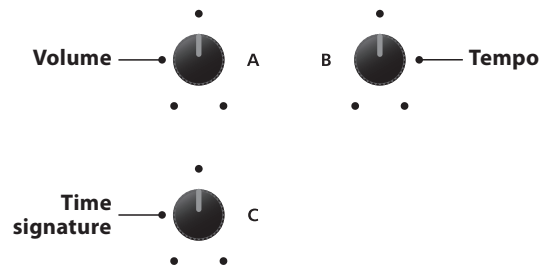

Press the F3 function button (LISTEN) to listen to the current metronome settings.

- * The metronome tempo can be adjusted within the range of 30-300 bpm (60-600 bpm for eighth note rhythms).
- * There are ten different types of beat/time signature available: 1/4, 2/4, 3/4, 4/4, 5/4, 3/8, 6/8, 7/8, 9/8, and 12/8.
- * Preferred metronome settings can be saved to a SETUP or POWERON memory for immediate recall.

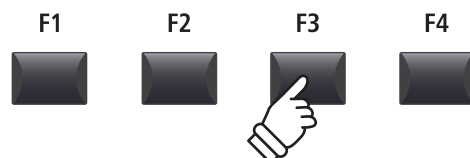

4. Returning to the Recorder function

Press the F4 function button (BACK) to return to the recorder function.

The LED indicator for the METRONOME button will remain lit, indicating that the metronome function is still activated.

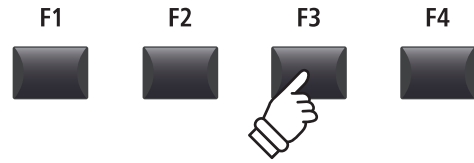

METRONOME



LED indicator remains ON:
Metronome is still activated

5. Starting the song recorder (standby mode)

Press the ● recorder control button.

The LED indicator for the ● button will start to flash, to indicate that the recorder is in standby mode.

* The F4 function button (REC) can also be used to engage standby mode.

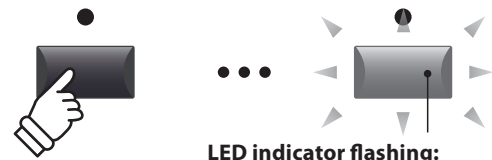

6. Starting the song recorder (recording)

Press the ▶/■ recorder control button or F4 button (REC).

The LED indicators for the ● and ▶/■ buttons will turn ON, a one bar count-in will be played, and recording will start.

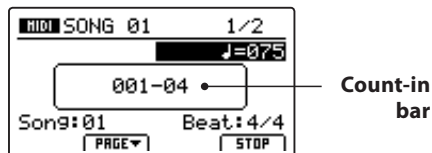

* Recording can also be started by pressing a key on the keyboard. In this case, recording will start immediately and the one bar count-in will not be played.

* When recording with the metronome in Click mode, the metronome sound will not be heard during playback. However, when recording with the metronome in Rhythm mode, the drum pattern will be heard during playback.

7. Stopping the song recorder

Press the ▶/■ recorder control button.

The LED indicators for the ● and ▶/■ buttons will turn OFF, and recording will stop.

* The F4 function button (STOP) can also be used to stop recording.

After a brief pause, the MIDI player screen will be shown in the LCD display.

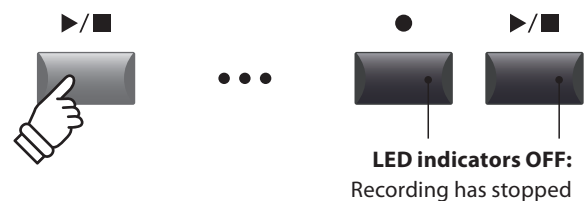
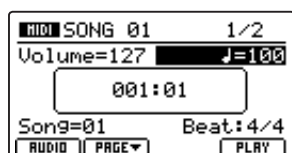

* The maximum recording capacity is approximately 90,000 notes, with button and pedal presses also counted as one note.

* If the maximum recording capacity is reached during recording, the recorder will stop automatically.

* Recorder songs will remain in memory after the power is turned OFF.

Overview of the USB Menu

The USB Menu contains functions to load, save, delete, and rename the various types of MP11 data stored on a USB memory device. It is also possible to format the memory device, erasing all stored data.

MP11 data types

Data type	Description	File extension
SOUND	A backup of a single SOUND's parameters.	.km5
SETUP	A backup of a single SETUP memory.	.km6
SMF	A standard MIDI format (SMF) song file.	.mid
Song	A MP3/WAV audio file or SMF song file.	.mp3, .wav, .mid
All Sound	A backup of all the MP11's stored SOUND parameters.	.km2
All Setup	A backup of all the MP11's SETUP memories.	.km3
All Backup	A backup of all the MP11's SETUP memories, SOUND parameters, and SYSTEM settings.	.km4

Entering the USB Menu

Connect a USB memory device.

* USB devices should be formatted to use the 'FAT' or 'FAT32' filesystems.

Press the USB button.

The LED indicator for the USB button will turn ON, and the USB Menu will be shown in the LCD display.

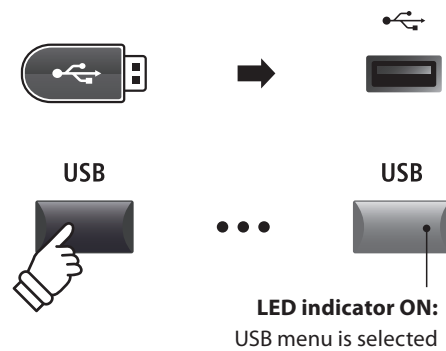

Selecting USB functions

Press the CURSOR buttons then the +/YES button or F4 function button (NEXT) to select and enter the desired category page.

Use the same control method again to select each function.

Press the -/NO or F1 function button (BACK) to return to the previous screen.

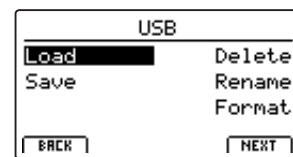

USB device file/folder listing screen

The MP11's file/folder listing screen lists relevant files and folders stored in the root of the USB device.

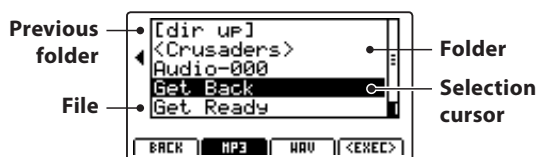

Press the CURSOR ▲▼ buttons to move the selection cursor.

* Control knob A can also be used to move the selection cursor.

Press the F4 function button (EXEC) or +/YES button to select the file or enter the selected folder.

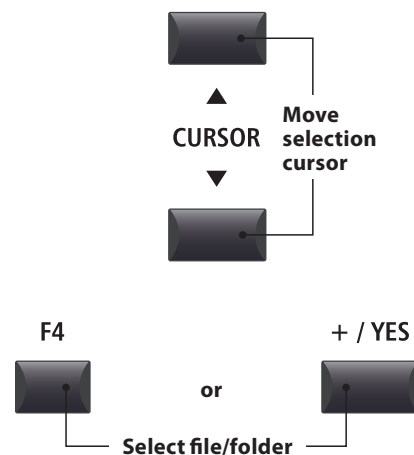

USB Menu functions

1 Load

These functions allow data stored on a USB memory device to be loaded into the instrument's internal memory.



Load functions will overwrite the existing data stored in internal memory. Exercise caution when using these functions in order to prevent accidental data loss.

1. Load One Sound

This function loads a SOUND file stored on a USB memory, replacing the preset parameters for that specific sound.

After selecting this function, select the desired SOUND file from the file/folder listing screen.

Finally, press the F2 or F3 function buttons to confirm or cancel the load operation.

* After loading, the SOUND will be selected automatically, and all other sections will be turned OFF. SETUPs will also be turned OFF.

3. Load SMF

This function loads an SMF song file stored on a USB memory device into the MP11's internal song recorder memory.

After selecting this function, select the desired SMF file from the file/folder listing screen. Then use the control knobs A, C, and D to specify the destination song memory and keyboard/drum channels.



Finally, press the F2 or F3 function buttons to confirm or cancel the load operation.

* After loading, the MIDI record/playback screen will be shown in the LCD display and the destination song memory will be selected automatically.

* For more information about the song recorder, please refer to page 64.

5. Load All Setup

This function restores all SETUP memories from an All Setup file stored on a USB memory device.

After selecting this function, select the desired All Setup file from the file/folder listing screen.

Finally, press the F2 or F3 function buttons to confirm or cancel the load operation.

2. Load One Setup

This function loads a SETUP file stored on a USB memory device into one of the MP11's 208 SETUP memories.

After selecting this function, select the desired SETUP file from the file/folder listing screen. Then press the BANK and SETUP memory buttons to specify the destination SETUP memory.

Finally, press the F2 or F3 function buttons to confirm or cancel the load operation.

* After loading, the SETUP will be selected automatically.

4. Load All Sound

This function replaces the preset parameters for all internal sounds from an All Sound file stored on a USB memory device.

After selecting this function, select the desired All Sound file from the file/folder listing screen.

Finally, press the F2 or F3 function buttons to confirm or cancel the load operation.

6. Load All Backup

This function restores the parameters for all SETUP memories, SOUND parameters, and SYSTEM settings from an All Backup file stored on a USB memory device.

After selecting this function, select the desired All Backup file from the file/folder listing screen.

Finally, press the F2 or F3 function buttons to confirm or cancel the load operation.

2 Save

These functions allow data stored in the instrument's internal memory to be saved to a USB memory device.

1. Save One Sound

This function saves the currently selected sound's parameters to a USB memory device.

* If the MIDI section is currently selected, the current PIANO section sound will be saved automatically.

After selecting this function, a confirmation screen will be shown in the LCD display. Press the F4 function button (NEXT) to continue.

Enter a name for the saved SOUND file using control knobs A and B, then press the F4 function button (EXEC).

Finally, press the F2 or F3 function buttons to confirm or cancel the save operation.

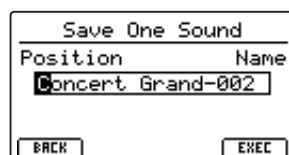
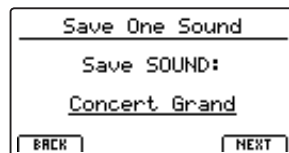

2. Save One Setup

This function saves a SETUP memory to a USB memory device.

After selecting this function, a confirmation screen will be shown in the LCD display. Press the BANK and SETUP memory buttons to specify the destination SETUP memory, then press the F4 function button (NEXT) to continue.

Enter a name for the saved SETUP file using control knobs A and B, then press the F4 function button (EXEC).

Finally, press the F2 or F3 function buttons to confirm or cancel the save operation.

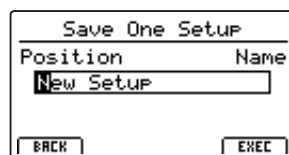
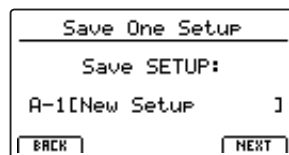

3. Save SMF

This function saves an internal recorder song to a USB memory device in SMF format.

After selecting this function, the Save SMF screen will be shown in the LCD display. Select the song memory to be saved using control knob C, and enter a name for the saved SMF file using control knobs A and B, then press the F4 function button (EXEC).

Finally, press the F2 or F3 function buttons to confirm or cancel the save operation.

* For more information about the song recorder, please refer to page 64.

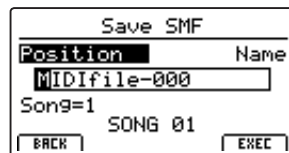

4. Save All Sound

This function saves the parameters for all internal sounds to a USB memory device.

After selecting this function, enter a name for the saved AllSound file using control knobs A and B, then press the F4 function button (EXEC).

6. Save All Backup

This function saves the parameters for all internal sounds, all SETUP memories, and all SYSTEM settings to a USB memory device.

After selecting this function, enter a name for the saved AllBackup file using control knobs A and B, then press the F4 function button (EXEC).

5. Save All Setup

This function saves all of the SETUP memories stored in the instrument to a USB memory device.

After selecting this function, enter a name for the saved AllSetup file using control knobs A and B, then press the F4 function button (EXEC).

3 Delete

These functions allow data stored on a USB memory device to be deleted.



Delete functions will erase data from the connected USB memory device. Exercise caution when using these functions in order to prevent accidental data loss.

1. Selecting the type of file to delete

Press the CURSOR buttons then the +/YES button or F4 function button (NEXT) to select the type of file to be deleted.

Press the -/NO or F1 function button (BACK) to return to the previous screen.

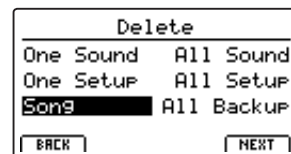

2. Selecting the file to delete

Turn control knob A or press the CURSOR buttons to move the selection cursor. Then press the +/YES button or F4 function button (EXEC) to delete the file.

Press the -/NO or F1 function button (BACK) to return to the previous screen.



3. Confirming the file deletion

Press the F2 function button (YES) or F3 function button (NO) to confirm or cancel the delete file operation.

After deleting the file, the main USB Menu will screen will be shown in the LCD display.



4 Rename

These functions allow data stored on a USB memory device to be renamed.

1. Selecting the type of file to rename

Press the CURSOR buttons then the +/YES button or F4 function button (NEXT) to select the type of file to be renamed.

Press the -/NO or F1 function button (BACK) to return to the previous screen.

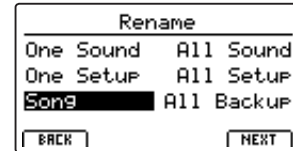

2. Selecting the file to rename

Turn control knob A or press the CURSOR buttons to move the selection cursor. Then press the +/YES button or F4 function button (EXEC) to rename the file.

Press the -/NO or F1 function button (BACK) to return to the previous screen.



3. Renaming the file

Turn control knobs A and B to move the position of the cursor and change the character, then press the F4 function button (EXEC) to rename the file.

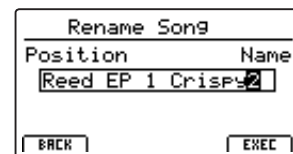

4. Confirming the file rename

Press the F2 function button (YES) or F3 function button (NO) to confirm or cancel the rename file operation.

After renaming the file, the main USB Menu will screen will be shown in the LCD display.

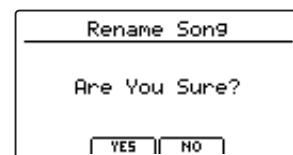

5 Format

This function allows a USB memory device to be formatted, erasing all stored data.



The Format function will erase all data stored on the connected USB memory device. Exercise caution when using this function in order to prevent accidental data loss.

1. Selecting the Format function

Press the CURSOR buttons then the +/YES button or F4 function button (NEXT) to select the format function.

Press the -/NO or F1 function button (BACK) to return to the previous screen.

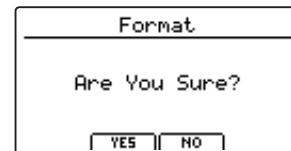

2. First confirmation prompt

The first confirmation prompt will be shown in the LCD display.

Press the +/YES button or F4 function button (EXEC) to select the proceed with the format function.

Press the -/NO or F1 function button (BACK) to return to the previous screen.

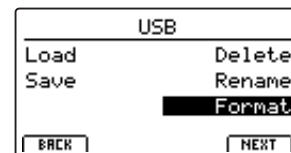

3. Final confirmation prompt

A final confirmation prompt will be shown in the LCD display.

Press the +/YES button or F4 function button (EXEC) to select the proceed with the format function.

Press the -/NO or F1 function button (BACK) to return to the previous screen.

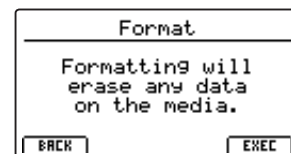

Overview of the SYSTEM Menu

The SYSTEM menu contains parameters and settings that affect the general operation of the MP11. These settings are grouped into six categories: Utility, Pedal, MIDI, Offset, User Edit, and Reset. SYSTEM parameters will be memorised automatically when instrument is turned OFF.

SYSTEM Menu parameters

Category	Parameters
Utility F4	System Tuning, Eff. SW Mode, Knob Action, Volume Fader Action, LCD Contrast, LCD Reverse, Input Level, Audio Output Mode, Lock SW Mode, Auto Power Off
Pedal F4	Right Pedal Mode, Center Pedal Mode, Left Pedal Mode, Half Pedal Adjust, Right Pedal Polarity, Center Pedal Polarity, Left Pedal Polarity, EXP Pedal Curve, EXP Pedal Polarity, EXP Pedal Calibrate, Right Pedal Calibrate
MIDI F4	System Channel, Key to MIDI, Key to USB, MIDI to MIDI, MIDI to USB, USB to MIDI, SETUP Program, SETUP Bank, SETUP Volume, SETUP Knobs, Receive Mode, PIANO Channel, E.PIANO Channel, SUB Channel
Offset F4	EQ Offset On/Off, Reverb Offset, EQ Offset Low, EQ Offset High, EQ Offset Mid1, EQ Offset Mid2
User Edit F4	User Touch Curve, User Temperament, User Key Volume, User Stretch Tuning
Reset	One Sound, All Sound, One Setup, All Setup, System, Power On, Recorder, Factory

Entering the SYSTEM Menu

Press the SYSTEM button.

The LED indicator for the SYSTEM button will turn ON, and the SYSTEM Menu will be shown in the LCD display.

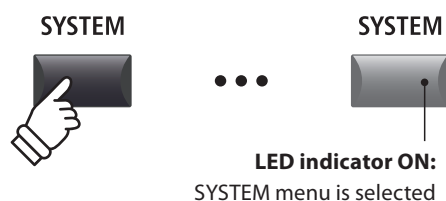
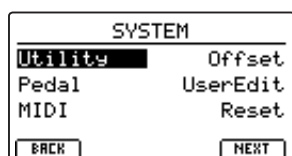

Selecting the SYSTEM parameter category

Press the CURSOR buttons to select, and then the F4 function button (NEXT) or +/YES button to enter the desired category.

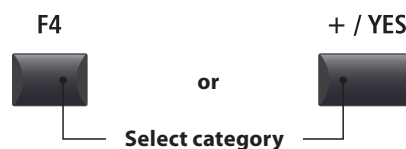

Adjusting SYSTEM parameters

Turn the four control knobs (A, B, C, D) to adjust the parameters assigned to those knob.

Parameters can also be adjusted by using the CURSOR buttons to move the selection cursor, and +/YES or -/NO buttons to increase or decrease the value of the selected parameter.

Press the F2 and F3 function buttons to cycle through the SYSTEM menu pages.

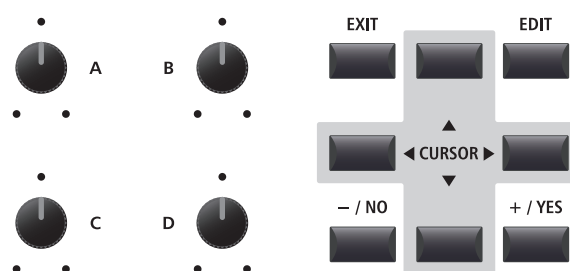

* The CURSOR ▲▼ buttons can also be used to cycle through pages.

* The adjusted SYSTEM parameters will be memorised automatically.

SYSTEM Menu parameters & functions

1 Utility

1. System Tuning

VALUE: 427.0 ~ 453.0 Hz

This parameter sets the global master tuning of the MP11 in 0.5Hz increments.

* The default setting is A = 440.0 Hz

3. Knob Action

NORMAL, CATCH

This parameter determines the adjustment behaviour of the four control knobs (A, B, C, D).

Mode	Description
Normal	Value changes immediately when control knob is turned.
Catch	Value does not change until control knob 'catches' the previously stored value, thus preventing unexpected jumps in parameter values.

* The default setting is Normal.

5. LCD Contrast

VALUE: 1 ~ 10

This parameter adjusts the contrast of the LCD display. The contrast becomes sharper as the value increases.

* The default setting is 5.

7. Input Level

VALUE: -18 dB ~ +18 dB

This parameter adjusts the gain of the MP11's LINE IN jacks.

If the output level of the external device is too high, reduce the value of this parameter. Alternatively, if the output is too low, increase the value of this parameter.

* The default setting is 0 dB.

9. Lock SW Mode

6 TYPES

This function determines which controls will be locked when the LOCK (🔒) button is pressed.

Mode	Description
Panel	The main control panel will be locked.
Bend	The pitch bend wheel will be locked.
Mod.	The modulation wheel will be locked.
Center	The centre pedal will be locked.
Left	The left pedal will be locked.
EXP	The expression pedal (EXP) will be locked.

* The default setting is Panel Lock.

2. Eff. SW Mode

PRESET, TEMP., FIXED

This function determines whether the ON/OFF state of the EFX, REVERB, and AMP buttons is recalled when selecting sounds.

Mode	Description
Preset	ON/OFF state is recalled when selecting sounds.
Temp.	ON/OFF state is not recalled when selecting sounds.
Fixed	ON/OFF state and Eff. Setting are not recalled when selecting sounds.

* The default setting is Preset.

4. Volume Fader Action

NORMAL, CATCH

This parameter determines the adjustment behaviour of the section volume faders.

Mode	Description
Normal	Volume changes immediately when fader is moved.
Catch	Volume does not change until fader 'catches' the previously stored volume value, thus preventing unexpected volume jumps.

* The default setting is Normal.

6. LCD Reverse

ON, OFF

This parameter inverts the black and white pixels of the LCD display, which may improve visibility in certain situations.

* The default setting is OFF.

8. Audio Out Mode

STEREO, 2xMONO

This parameter allows the MP11's LINE OUT signal to be changed from stereo to dual-mono.

This may be useful in certain situations, allowing one output to be used for a monitor speaker and the other to be plugged into the mixing console.

Mode	Description
Stereo	The Line-out signal is normal stereo.
2xMono	The Line-out signal is mono on both jacks.

* The default setting is Stereo.

* Stereo EFX such as AutoPan will be turned OFF when 2xMono is selected.

10. Auto Power Off

OFF, 30 MINS., 60 MINS., 120 MINS.

This parameter determines the period of inactivity that should pass before the MP11 automatically turns OFF.

Value	Description
Off	The Auto Power Off function is disabled.
30 mins.	The MP11 will turn off after 30 minutes of inactivity.
60 mins.	The MP11 will turn off after 60 minutes of inactivity.
120 mins.	The MP11 will turn off after 120 minutes of inactivity.

* The default setting for this parameter depends on the market region.

2 Pedal

1. Right Pedal Mode

5 FUNCTIONS

This parameter determines the global operation for the right pedal of the F-30 pedal unit.

* The default setting is Normal.

2. Center Pedal Mode

5 FUNCTIONS

This parameter determines the global operation for the centre pedal of the F-30 pedal unit.

* The default setting is Normal.

4. Half Pedal Adjust

VALUE: 1 ~ 10

This parameter adjusts the point at which the damper/sustain pedal becomes effective (i.e. when the dampers of the piano begin to lift from the strings).

This parameter may be useful for pianists that habitually rest their right foot on the damper/sustain pedal, but do not necessarily wish to sustain the sound.

* The default setting is 5.

6. Center Pedal Polarity

NORMAL, REVERSE

This parameter changes the polarity for the centre pedal.

* The default setting is Normal.

8. EXP Pedal Curve

NORMAL, SLOW, FAST

This parameter changes the output level curve for the connected expression (EXP) pedal, providing additional control over the speed of expression pedal controlled effects.

* The default setting is Normal.

■ Pedal modes

Mode	Description
Normal	The pedal will use the assigned EDIT menu function.
Setup+	The pedal will select the next SETUP memory.
Setup-	The pedal will select the previous SETUP memory.
Playback	The pedal will start/stop song playback.
Metro.	The pedal will start/stop the metronome.

3. Left Pedal Mode

5 FUNCTIONS

This parameter determines the global operation for the left pedal of the F-30 pedal unit.

* The default setting is Normal.

5. Right Pedal Polarity

NORMAL, REVERSE

This parameter changes the polarity for the right pedal.

When using the included F-30 triple pedal unit, it is recommended to leave this parameter set to 'Normal'. When using an alternative pedal, it may be necessary to select the 'Reverse' setting.

* The default setting is Normal.

7. Left Pedal Polarity

NORMAL, REVERSE

This parameter changes the polarity for the left pedal.

* The default setting is Normal.

9. EXP Pedal Polarity

NORMAL, REVERSE

This parameter changes the polarity for the connected expression (EXP) pedal.

* The default setting is Normal.

Normal curve

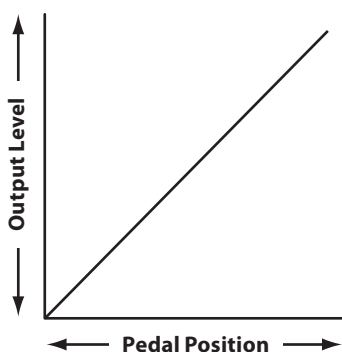

Slow curve

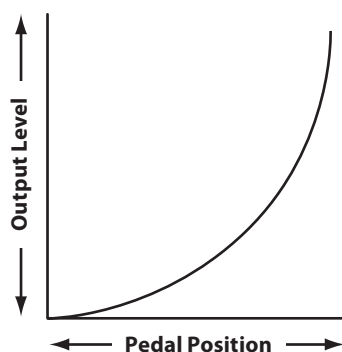

Fast curve

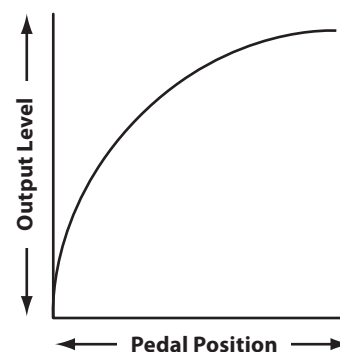

Expression pedal calibration

Depending on the brand and model of expression pedal connected to the MP11, it may be necessary to use the calibration function to ensure that the pedal's minimum and maximum range of values are detected correctly.

■ Calibrating the EXP pedal

Select the third page (3/3) of the Pedal SYSTEM menu.

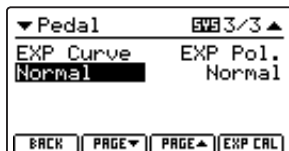

Press the F4 function button (EXP CAL) to show the expression pedal calibration screen in the LCD display.

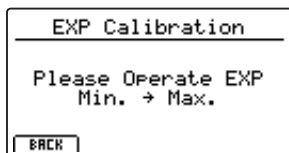

Press the expression pedal to the minimum and maximum positions several times to transmit the full range of values.

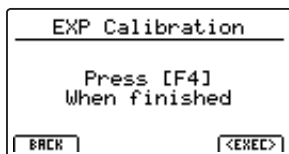

Press F4 function button (EXEC) to complete the expression pedal calibration.



The full range of operation for the connected expression pedal will be calculated automatically.

Right (damper) pedal calibration

As with the expression pedal, it may also be desirable to use the right pedal calibration function to ensure that the damper pedal's minimum and maximum range of values are detected correctly.

■ Calibrating the Right (damper) pedal

Select pages 1/3 or 2/3 of the Pedal SYSTEM menu.

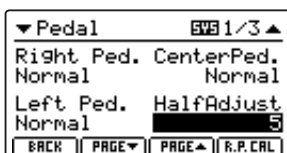

Press the right pedal to the lowest position to transmit the maximum value.

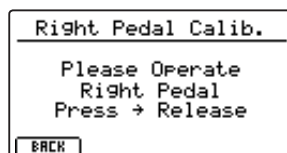

Press F4 function button (EXEC) to complete the right pedal calibration.

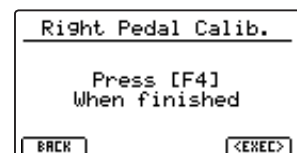

Press the F4 function button (R.P. CAL) to show the right pedal calibration screen in the LCD display.

The full range of operation for the connected right (damper) pedal will be calculated automatically.

3 MIDI

1. System Channel

VALUE: 01CH ~ 16CH

This parameter determines the System MIDI channel used to receive MIDI messages when Receive Mode is set to Panel.

* The default setting is 01Ch.

3. Key to USB

ON, OFF

This parameter determines whether or not keyboard events are transmitted via USB-MIDI.

* The default setting is ON.

5. MIDI to USB

ON, OFF

This parameter determines whether or not received MIDI IN events are transmitted via USB-MIDI.

* The default setting is OFF.

7. SETUP Program

ON, OFF

This parameter determines whether or not the Send Program parameter in the EDIT menu (MIDI OUT/SETUP) is enabled.

* For more information about the Send Program parameter, please refer to page 54.

* The default setting is OFF.

9. SETUP Volume

ON, OFF

This parameter determines whether or not the Send Volume parameter in the EDIT menu (MIDI OUT/SETUP) is enabled.

* For more information about the Send Volume parameter, please refer to page 54.

* The default setting is OFF.

11. Receive Mode

PANEL, SECTION, OMNI ON

This parameter determines how the MP11 receives MIDI data.

Mode	Description
Panel	Received data controls the entire panel.
Section	Received data controls sections individually via each receive channel.
Omni On	Received data controls the whole panel, regardless of the MIDI channel.

* The default setting is Panel.

13. E.PIANO Channel

VALUE: 01CH ~ 16CH

This parameter determines the E.PIANO section's Receive Channel when the Receive Mode parameter is set to Section.

* The default setting is 02Ch.

2. Key to MIDI

ON, OFF

This parameter determines whether or not keyboard events are transmitted via MIDI OUT.

* The default setting is ON.

4. MIDI to MIDI

ON, OFF

This parameter determines whether or not received MIDI IN events are transmitted via MIDI OUT.

* The default setting is OFF.

6. USB to MIDI

ON, OFF

This parameter determines whether or not received USB-MIDI events are transmitted via MIDI OUT.

* The default setting is OFF.

8. SETUP Bank

ON, OFF

This parameter determines whether or not the Send Bank parameter in the EDIT menu (MIDI OUT/SETUP) is enabled.

* For more information about the Send Bank parameter, please refer to page 54.

* The default setting is OFF.

10. SETUP Knobs

ON, OFF

This parameter determines whether or not the Send Knobs parameter in the EDIT menu (MIDI OUT/SETUP) is enabled.

* For more information about the Send Knobs parameter, please refer to page 54.

* The default setting is OFF.

12. PIANO Channel

VALUE: 01CH ~ 16CH

This parameter determines the PIANO section's Receive Channel when the Receive Mode parameter is set to Section.

* The default setting is 01Ch.

14. SUB Channel

VALUE: 01CH ~ 16CH

This parameter determines the SUB section's Receive Channel when the Receive Mode parameter is set to Section.

* The default setting is 03Ch.

4 Offset

1. EQ Offset ON/OFF ON, OFF

This parameter turns the EQ Offset function ON or OFF.

The EQ Offset function may be useful when performing at a venue with certain room acoustics, or simply different amplifier and speaker equipment to that used normally. The Offset values can be adjusted to create a 'baseline' character for the instrument, rather than readjusting the EQ settings prepared for each SETUP.

* The default setting is OFF.

* The EQ Offset values will be added to the EQ values defined in each SETUP. The combined EQ values are limited to ± 10 dB.

3. EQ Offset Low VALUE: -10 dB ~ +10 dB

This parameter adjusts the EQ Offset gain for the low range frequency band.

* The default setting is 0 dB.

5. EQ Offset Mid1 VALUE: -10 dB ~ +10 dB

This parameter adjusts the EQ Offset gain for the Mid1 range frequency band.

* The default setting is 0 dB.

2. Reverb Offset VALUE: 0% ~ 100%

This parameter adjusts the reverb depth offset, allowing the reverb for all sound section to be reduced globally.

Similar to the EQ Offset function, Reverb Offset may be useful when performing at a venue with reflective acoustics, or when connecting the instrument to a PA system with reverb pre-applied. The reverb offset depth is reduced globally for all sound sections, negating the need to readjust reverb settings for each SETUP.

* The default setting is 100%.

4. EQ Offset High VALUE: -10 dB ~ +10 dB

This parameter adjusts the EQ Offset gain for the high range frequency band.

* The default setting is 0 dB.

6. EQ Offset Mid2 VALUE: -10 dB ~ +10 dB

This parameter adjusts the EQ Offset gain for the Mid2 range frequency band.

* The default setting is 0 dB.

5 User Edit

The User Edit category contains functions to create custom touch curves and keyboard temperaments.

■ Selecting the User Touch Curve / Temperament / Key Volume / Stretch Tuning to edit

After selecting the User Edit SYSTEM menu category:

Turn control knob A to select the desired User Touch Curve.
 Turn control knob B to select the desired User Temperament.
 Turn control knob C to select the desired User Key Volume.
 Turn control knob D to select the desired User Stretch Tuning.

The User Touch Curve, User Temperament, User Key Volume, and User Stretch Tuning can also be selected by using the CURSOR buttons and +/YES or -/NO buttons.

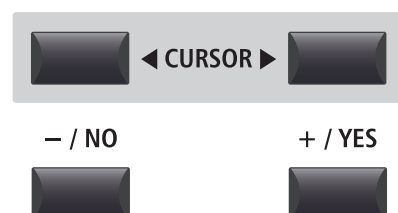
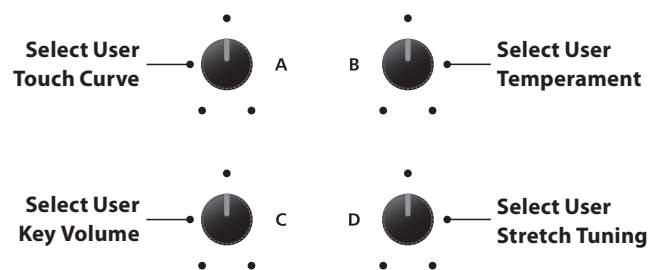
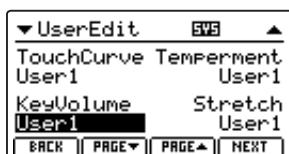

Creating a User Touch Curve

1. Starting the User Touch Curve analysis

After selecting the User Touch Curve memory to be edited:

Press the F4 function button (NEXT) to start the User Touch Curve analysis.

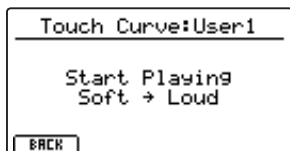

2. Capturing the dynamic range

Play the piano dynamically from very soft to very loud, allowing the instrument to analyse the personal playing technique.

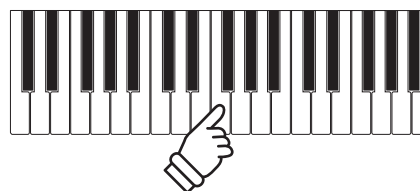
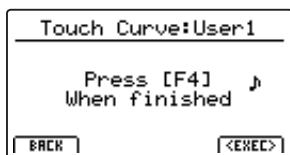

3. Completing the User Touch Curve analysis

Press the F4 function button (EXEC) to complete the User Touch Curve analysis.

A confirmation screen will be shown in the LCD display.

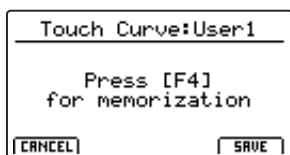

Play the piano to check the newly created touch curve, then press the F4 function button (SAVE) to store it to user memory.



4. Storing the User Touch Curve

Press the F2 button (YES) to confirm the store operation, or the F3 button (NO) to return to the previous screen.

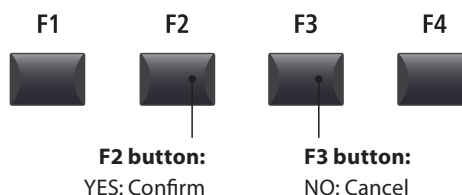
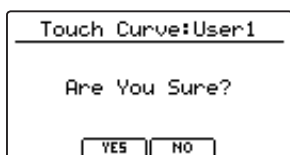

* The +/YES and -/NO buttons can also be used to confirm or cancel the store operation.

* More than one attempt may be required in order to create an accurate User Touch Curve.

The new User Touch Curve will be used for the selected sound section automatically.

* Reducing the master volume fader to the lowest position before creating the User Touch Curve may help to reduce user distractions, thus improving accuracy.

Creating a User Temperament

1. Selecting the User Temperament editor

After selecting the User Temperament to be edited:

Press the F4 function button (NEXT) to select the User Temperament editor.

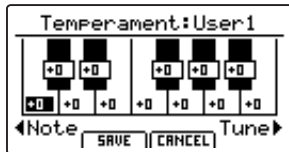

2. Adjusting the User Temperament

Turn control knob C to select the note to be adjusted.
Turn control knob D to adjust the pitch of the selected note.

* The pitch of each key can be adjusted within the range of -50 ~ +50 cents.
One semi-tone = 100 cents.

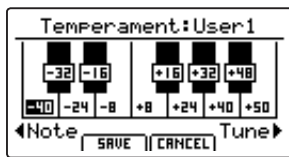

3. Saving the User Temperament

After adjusting the note pitches:

Press the F2 function button (SAVE) to save the adjusted User Temperament.

A store confirmation screen will be shown in the LCD display.

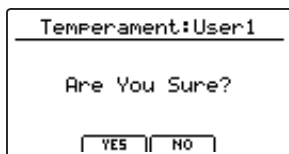
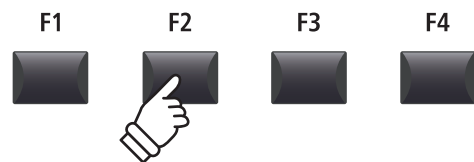

4. Confirming the store operation

Press the F2 button (YES) to confirm the store operation, or the F3 button (NO) to return to the previous screen.

* The +/YES and -/NO buttons can also be used to confirm or cancel the store operation.

The new User Temperament will be used for the selected sound section automatically.

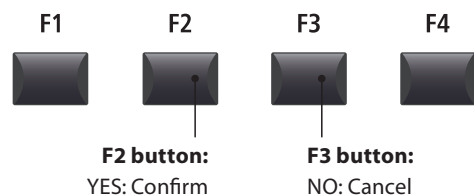

Selected User Temperament

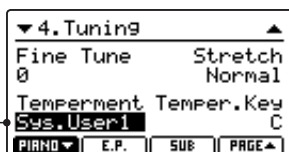

Creating a User Key Volume

1. Selecting the User Key Volume editor

After selecting the User Key Volume to be edited:

Press the F4 function button (NEXT) to select the User Key Volume editor.

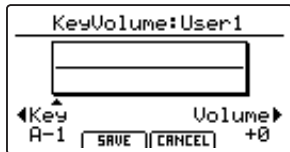

2. Adjusting the User Key Volume

Turn control knob C to select the key to be adjusted.
Turn control knob D to adjust the volume of the selected key.

* The volume of each key can be adjusted within the range of -50 ~ +50.

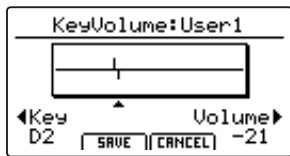

3. Saving the User Key Volume

After adjusting the key volumes:

Press the F2 function button (SAVE) to save the adjusted User Key Volume.

A store confirmation screen will be shown in the LCD display.

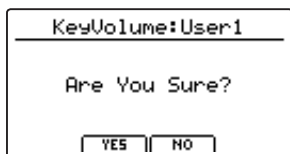
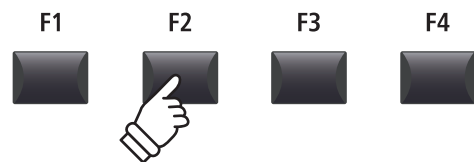

4. Confirming the store operation

Press the F2 button (YES) to confirm the store operation, or the F3 button (NO) to return to the previous screen.

* The +/YES and -/NO buttons can also be used to confirm or cancel the store operation.

The new User Key Volume will be used for the selected sound section automatically.

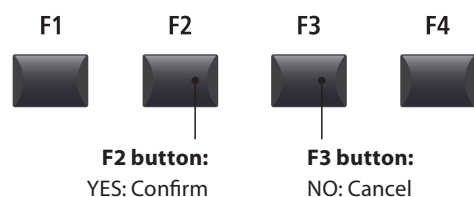

Creating a User Stretch Tuning

1. Selecting the User Stretch Tuning editor

After selecting the User Stretch Tuning to be edited:

Press the F4 function button (NEXT) to select the User Stretch Tuning editor.

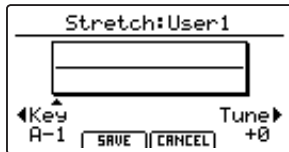

2. Adjusting the User Stretch Tuning

Turn control knob C to select the key to be adjusted.
Turn control knob D to adjust the pitch of the selected key.

* The pitch of each key can be adjusted within the range of -50 ~ +50 cents.
One semi-tone = 100 cents.

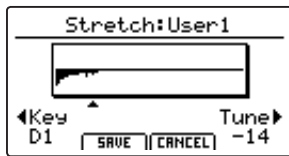

3. Saving the User Stretch Tuning

After adjusting the key pitches:

Press the F2 function button (SAVE) to save the adjusted User Stretch Tuning.

A store confirmation screen will be shown in the LCD display.

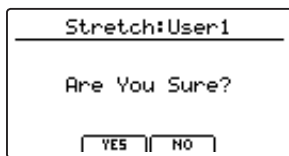
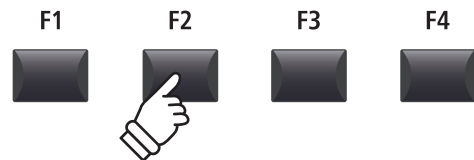

4. Confirming the store operation

Press the F2 button (YES) to confirm the store operation, or the F3 button (NO) to return to the previous screen.

* The +/YES and -/NO buttons can also be used to confirm or cancel the store operation.

The new User Stretch Tuning will be used for the selected sound section automatically.

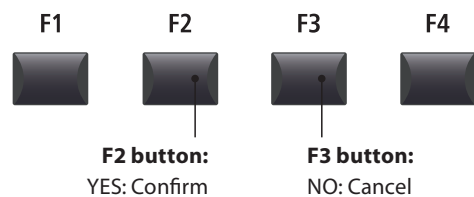

6 Reset

The Reset category contains functions to reset sounds, setups, and settings back to the original factory default.



Once performed, these Reset functions cannot be undone. Exercise caution when using this function in order to prevent accidental data loss.

1. Reset One Sound

This function resets the currently selected sound to the factory default.

The currently selected sound will be shown in the LCD display.

* It is also possible to select the sound to be reset by pressing the sound category and variation buttons.

2. Reset One Setup

This function resets the currently selected SETUP memory to the factory default.

The currently selected SETUP will be shown in the LCD display.

* It is also possible to select the SETUP memory to be reset by pressing the BANK ◀▶ buttons and SETUP memory buttons.

3. Reset All Sound

This function resets all sounds to the factory default.

4. Reset All Setup

This function resets all SETUP memories to the factory default.

5. Reset System

This function resets all SYSTEM parameters, including Utility, Pedal, Offset, and MIDI parameters in the SYSTEM menu, and SETUP, Transmit, and MMC parameters in the MIDI section EDIT menu.

6. Reset PowerOn

This function resets the PowerOn memory to the factory default.

7. Reset Recorder

This function resets all internal song recorder memories.

8. Factory Reset

This function performs a global reset of all sounds, SETUPS, SYSTEM settings, and internal song recorder memories.

Panic button

The PANIC button restores all internal sounds to their default PowerOn setting, and also sends the AllNoteOff and ResetAll Controller MIDI messages to any connected devices (01ch ~ 16ch).

This is a useful function to be used in emergency situations, or to immediately restore the MP11 to a preferred configuration without turning the power OFF and ON.

■ Activating the Panic function

Press and hold the PANIC button.

After one second, the MP11 will be returned to the default PowerOn configuration.

PANIC



Panel Lock (🔒)

The Lock (🔒) function allows the state of the MP11's various controls to be temporarily locked, preventing accidental button pushes, pedal presses, or wheel movements.

■ Activating and deactivating the Lock function

Press the LOCK (🔒) button.

The LED indicator for the LOCK (🔒) button will turn on, and the lock pop-up will be briefly shown in the LCD display.

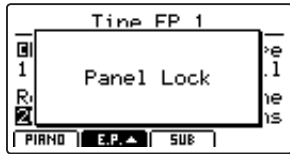

By default, the Lock function will lock all of the MP11's panel buttons and knobs (Panel Lock), preventing any accidental adjustments during performances etc.

* The VOLUME, LINE IN, and section VOLUME faders will not be locked. The keyboard will also remain active.

Press the LOCK (🔒) button again to deactivate the lock.



■ Changing the Lock mode

Press and hold the LOCK (🔒) button, then press the +/YES or -/NO buttons to cycle through the different Lock modes.

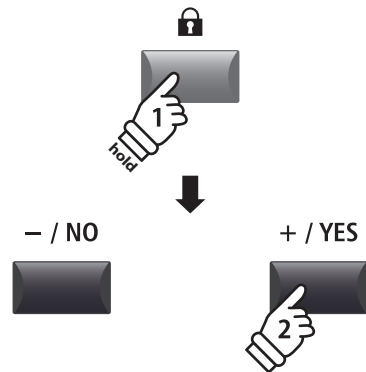
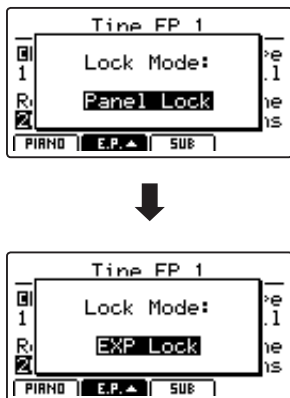

* The Lock mode can also be changed in the SYSTEM menu. For more information, please refer to page 99.

■ Lock modes

Lock mode	Description
Panel Lock	The main control panel buttons and knobs will be locked.
Bend Lock	The pitch bend wheel will be locked.
Mod. Lock	The modulation wheel will be locked.
Center Lock	The centre pedal will be locked.
Left Lock	The left pedal will be locked.
EXP Lock	The expression pedal (EXP) will be locked.

USB MIDI (USB to Host connector)

The MP11 features a 'USB to Host' type connector, allowing the instrument to be connected to a computer using an inexpensive USB cable and utilised as a MIDI device. Depending on the type of computer and operating system installed, additional driver software may be required for USB MIDI communication to function correctly.

■ USB MIDI driver

Operating System	USB MIDI Driver Support
Windows ME Windows XP (no SP, SP1, SP2, SP3) Windows XP 64-bit Windows Vista (SP1, SP2) Windows Vista 64-bit (SP1, SP2) Windows 7 (no SP, SP1) Windows 7 64-bit Windows 8 Windows 8 64-bit	Additional USB MIDI driver software NOT required. The standard (built-in) Windows USB MIDI driver will be installed automatically when the instrument is connected to the computer. * After driver installation, ensure that the 'USB Audio Device' (Windows ME/Windows XP) or 'USB-MIDI' (Windows Vista/Windows 7/Windows 8) device is correctly selected in the application software.
Windows 98 se Windows 2000 Windows Vista (no SP)	Additional USB MIDI driver software required. Please download the USB MIDI driver from the Kawai Japan website: → http://www.kawai.co.jp/english * After driver installation, ensure that the 'KAWAI USB MIDI' device is correctly selected in the application software.
Windows Vista 64-bit (no SP)	USB MIDI is not supported. Please upgrade to service pack 1 or service pack 2.
Mac OS X	Additional USB MIDI driver software NOT required. The standard (built-in) Mac OS X USB MIDI driver will be installed automatically when the instrument is connected to the computer.
Mac OS 9	USB MIDI is not supported. Please use the standard MIDI IN/OUT connectors.

■ USB MIDI information

- The instrument's USB MIDI port and MIDI IN/OUT jacks can be connected and used simultaneously. To adjust MIDI routing, please refer to the MIDI parameters in the SYSTEM menu, explained on page 102.
- Ensure that the instrument is turned OFF before attempting to connect the USB MIDI cable.
- When connecting the instrument to a computer using the USB MIDI port, there may be a short delay before communications begin.
- If the instrument is connected to a computer via a USB hub and USB MIDI communication becomes unreliable/unstable, please connect the USB MIDI cable directly to the one of the computer's USB ports.
- Disconnecting the USB MIDI cable suddenly, or turning the instrument on/off while using USB MIDI may cause computer instability in the following situations:
 - while installing the USB MIDI driver
 - while starting up the computer
 - while MIDI applications are performing tasks
 - while the computer is in energy saver mode
- If there are any further problems experienced with USB MIDI communication while the instrument is connected, please double-check all connections and relevant MIDI settings in the computer's operating system.

* 'MIDI' is a registered trademark of the Association of Manufacturers of Electronic Instruments (AMEI).

* 'Windows' is registered trademark of Microsoft Corporation.

* 'Macintosh' is registered trademark of Apple Computer, Inc.

* Other company names and product names mentioned referenced herein may be registered trademarks or trademarks of respective owners.

Software Update

This page contains instructions for updating the system software of the MP11, when issued by Kawai. Please read these instructions thoroughly before attempting to perform the software update.

■ Checking the software version

To check the current software version installed on the MP11, press and hold the STORE button, then turn the instrument ON.

The current software (Program) version will be shown on the first line of the LCD display.

If the Program version number is greater than or equal to the update version, no further action is necessary.

* Turn the instrument OFF and ON to return to normal operation.

If the Program version number is lower than the update version, please continue to follow the instructions below.

STORE

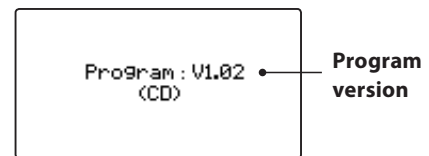

1. Prepare the USB memory device

Extract the software update ZIP file and copy the included .SYS files to the root folder of a USB memory device.

* USB devices should be formatted to use the 'FAT' or 'FAT32' filesystems.



2. Connect the USB memory device

While the instrument is turned off:

Connect the prepared USB memory device to the USB port.



3. Start the update

Press and hold buttons 6, 7, and 8 in the SETUP section, then turn on the instrument.

The update process will start automatically after a few seconds, and status messages will be shown in the LCD display.

* Do not remove the USB memory device while the software update is in progress.

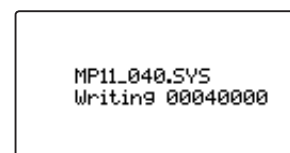
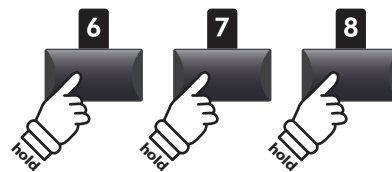

4. Finish the update, disconnect the USB memory device

After approximately 60-90 seconds (depending on the number of update files), a message will be shown in the LCD display, indicating that the software update has been successful.

Disconnect the USB memory device, then press and hold the POWER switch to turn the instrument OFF. When the instrument is turned ON, the updated software will be used automatically.

* If the software update is unsuccessful, restart the process from step 1.

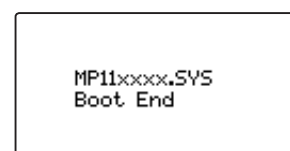

Sound List

PIANO section

Concert		Pop		Jazz		Upright / Mono	
1	Concert Grand	1	Pop Piano	1	Jazz Grand 1	1	Upright Piano
2	Studio Grand	2	Bright Pop Piano	2	Jazz Grand 2	2	Mono Pop Piano
3	Mellow Grand	3	Mellow Pop Piano	3	Standard Grand	3	Mono Concert

E.PIANO section

Tine		Reed		Modern		E. Grand / Clavi	
1	Tine EP 1	1	Reed EP 1	1	Modern EP 1	1	Electric Grand
2	Tine EP 2	2	Reed EP 2	2	Modern EP 2	2	Clavi 1
3	Tine EP 3	3	Reed EP 3	3	Modern EP 3	3	Clavi 2

SUB section

Strings		Pad		Harpsi / Mallet		Bass	
1	String Ensemble	1	Pad 1	1	Vibraphone	1	Wood Bass
2	Beautiful Str.	2	Pad 2	2	Harpsichord	2	Finger Bass
3	String Pad	3	Pad 3	3	Celesta	3	Fretless Bass
4	Warm Strings	4	Pad 4	4	Marimba	4	Wood Bass & Ride

Rhythm Pattern List

16 Swing	
1	Funk Shuffle 1
2	Funk Shuffle 2
3	Hip Hop 1
4	Hip Hop 2
5	Hip Hop 3
6	Hip Hop 4
7	16 Shuffle 1
8	16 Shuffle 2
9	16 Shuffle 3

16 Funk	
10	Funky Beat 1
11	Funky Beat 2
12	Funky Beat 3
13	Funk 1
14	Funk 2
15	Funk 3

16 Straight	
16	Jazz Funk
17	16 Beat 1
18	16 Beat 2
19	16 Beat 3
20	16 Beat 4
21	Ride Beat 4
22	Rim Beat
23	Roll Beat
24	Light Ride 1
25	Dixie Rock

16 Latin	
26	Surdo Samba
27	Latin Groove
28	Light Samba
29	Songo
30	Samba
31	Merenge

16 Dance	
32	Funky Beat 4
33	16 Beat 5
34	Disco 1
35	Disco 2
36	Techno 1
37	Techno 2
38	Techno 3
39	Heavy Techno

16 Ballad	
40	Ballad 1
41	Ballad 2
42	Ballad 3
43	Ballad 4
44	Ballad 5
45	Light Ride 2
46	Electro Pop 1
47	Electro Pop 2
48	16 Shuffle 4

8 Ballad	
49	Slow Jam
50	50's Triplet
51	R&B Triplet

8 Straight	
52	8 Beat 1
53	8 Beat 2
54	Smooth Beat
55	Pop 1
56	Pop 2
57	Ride Beat 1
58	Ride Beat 2
59	Ride Beat 3
60	Slip Beat

8 Rock	
61	Jazz Rock
62	8 Beat 3
63	Rock Beat 1
64	Rock Beat 2
65	Rock Beat 3
66	Rock Beat 4
67	Blues/Rock
68	Heavy Beat
69	Hard Rock
70	Surf Rock
71	R&B

8 Swing	
72	Motown 1
73	Fast Shuffle
74	Motown 2
75	Country 2 Beat

Triplet	
76	Triplet Rock 1
77	Triplet Rock 2
78	Bembe
79	Rock Shuffle 1
80	Rock Shuffle 2
81	Boogie
82	Triplet 1
83	Triplet 2
84	Reggae
85	Gospel Ballad
86	Waltz

Jazz	
87	H.H. Swing
88	Ride Swing
89	Fast 4 Beat
90	Afro Cuban
91	Jazz Waltz 1
92	Jazz Waltz 2
93	5/4 Swing

8 Latin	
94	H.H. Bossa
95	Ride Bossa
96	Beguine
97	Mambo
98	Cha Cha
99	Tango
100	Habanera

EFX Categories, Types, & Parameters

1. Chorus

Variation	Parameter 1	Parameter 2	Parameter 3	Parameter 4	Parameter 5	Parameter 6	Parameter 7	Parameter 8	Parameter 9	Parameter 10
Stereo	DryWet	Speed	Depth	PreDelay	Phase	-	LowEQ	HighEQ	-	-
Classic	Spread	Intensity	LowEQ	HighEQ	-	-	-	-	-	-
2-Band	DryWet	Balance	LowerSpeed	LowerDepth	UpperSpeed	UpperDepth	PreDelay	SplitFreq	-	-
3-Phase	DryWet	Speed	Depth	PreDelay	-	-	-	-	-	-
Wide	DryWet	Speed	Depth	PreDelay	-	-	-	-	-	-
Envelope	Depth	Speed	Sens.	PreDelay	Phase	-	-	-	-	-
Triangle	DryWet	Speed	Depth	PreDelay	Phase	-	-	-	-	-
Sine	DryWet	Speed	Depth	PreDelay	-	-	-	-	-	-

2. Flanger

Variation	Parameter 1	Parameter 2	Parameter 3	Parameter 4	Parameter 5	Parameter 6	Parameter 7	Parameter 8	Parameter 9	Parameter 10
Stereo	DryWet	Speed	Depth	Feedback	PreDelay	Phase	LowEQ	HighEQ	-	-
2-Band	DryWet	Balance	LowerSpeed	LowerDepth	UpperSpeed	UpperDepth	Feedback	PreDelay	SplitFreq	-
Touch	DryWet	-	Sens.	Feedback	PreDelay	-	LowEQ	HighEQ	-	-
Sine	DryWet	Speed	Depth	Feedback	PreDelay	-	-	-	-	-
Triangle	DryWet	Speed	Depth	Feedback	PreDelay	Phase	-	-	-	-

3. Phaser

Variation	Parameter 1	Parameter 2	Parameter 3	Parameter 4	Parameter 5	Parameter 6	Parameter 7	Parameter 8	Parameter 9	Parameter 10
Warm	DryWet	Speed	Depth	Resonance	LowEQ	HighEQ	-	-	-	-
Classic	DryWet	Speed	Depth	Resonance	Manual	-	LowEQ	HighEQ	-	-
8-Stage	DryWet	Speed	Depth	Resonance	Manual	-	-	-	-	-
2-Band	DryWet	Balance	LwrSpeed	LwrDepth	LwrManual	-	UprSpeed	UprDepth	UprManual	SplitFreq
Touch	DryWet	-	Sens.	Resonance	Manual	-	LowEQ	HighEQ	-	-
St.2-Stage	DryWet	Speed	Depth	-	Manual	Phase	-	-	-	-

4. Wah

Variation	Parameter 1	Parameter 2	Parameter 3	Parameter 4	Parameter 5	Parameter 6	Parameter 7	Parameter 8	Parameter 9	Parameter 10
ClassicTch	DryWet	-	Sens.	Resonance	Manual	-	LowEQ	HighEQ	-	-
ClassicLfo	DryWet	Speed	Depth	Resonance	Manual	-	LowEQ	HighEQ	-	-
ClassicPdl	DryWet	-	Sens.	Resonance	Manual	-	LowEQ	HighEQ	*PDL	-
LpfTch	DryWet	-	Sens.	Manual	-	-	-	-	-	-
LpfLfo	DryWet	Speed	Depth	Manual	-	-	-	-	-	-
LpfPdl	DryWet	-	Sens.	Manual	*PDL	-	-	-	-	-

5. Tremolo

Variation	Parameter 1	Parameter 2	Parameter 3	Parameter 4	Parameter 5	Parameter 6	Parameter 7	Parameter 8	Parameter 9	Parameter 10
Classic	Depth	Speed	LowEQ	HighEQ	-	-	-	-	-	-
2-Band	Depth	Balance	LowerSpeed	UpperSpeed	SplitFreq	-	-	-	-	-
VibratoTrm	Depth	Speed	Vibrato	-	LowEQ	HighEQ	-	-	-	-
Sine	Depth	Speed	-	-	-	-	-	-	-	-
Square	Depth	Speed	-	-	-	-	-	-	-	-
Saw	Depth	Speed	-	-	-	-	-	-	-	-

6. Auto Pan

Variation	Parameter 1	Parameter 2	Parameter 3	Parameter 4	Parameter 5	Parameter 6	Parameter 7	Parameter 8	Parameter 9	Parameter 10
Classic	Depth	Speed	LowEQ	HighEQ	-	-	-	-	-	-
2-Band	Depth	Balance	LowerSpeed	UpperSpeed	SplitFreq	-	-	-	-	-
Envelope	Depth	Speed	Sens.	-	-	-	-	-	-	-
Standard	Depth	Speed	-	-	-	-	-	-	-	-

7. Delay / Reverb

Variation	Parameter 1	Parameter 2	Parameter 3	Parameter 4	Parameter 5	Parameter 6	Parameter 7	Parameter 8	Parameter 9	Parameter 10
Standard	DryWet	Time	Feedback	HighDamp	-	-	-	-	-	-
PingPong	DryWet	Time	Feedback	HighDamp	-	-	-	-	-	-
LCR	DryWet	Time	Feedback	HighDamp	-	-	-	-	-	-
3-Tap	DryWet	-	CenterTime	CenterGain	Feedback	HighDamp	LeftTime	LeftGain	RightTime	RightGain
Classic	DryWet	Time	Feedback	-	-	-	-	-	-	-
Short	DryWet	Time	Feedback	-	-	-	-	-	-	-
Ambience	DryWet	Size	HighDamp	-	LowEQ	HighEQ	-	-	-	-
EarlyRef	DryWet	Size	PreDelay	LPF	LowEQ	HighEQ	-	-	-	-

8. Pitch Shift

Variation	Parameter 1	Parameter 2	Parameter 3	Parameter 4	Parameter 5	Parameter 6	Parameter 7	Parameter 8	Parameter 9	Parameter 10
Detune	DryWet	Fine	-	-	-	-	-	-	-	-
FeedBack	DryWet	Fine	Coarse	DelayTime	Feedback	HighDamp	-	-	-	-
Standard	DryWet	Fine	Coarse	-	-	-	-	-	-	-

9. Compressor

Variation	Parameter 1	Parameter 2	Parameter 3	Parameter 4	Parameter 5	Parameter 6	Parameter 7	Parameter 8	Parameter 9	Parameter 10
2-Band	Gain	Balance	LwrRatio	LwrThresh	LwrAttack	Release	UprRatio	UprThresh	UprAttack	SplitFreq
Standard	Gain	-	Ratio	Threshold	Attack	Release	-	-	-	-

10. Overdrive

Variation	Parameter 1	Parameter 2	Parameter 3	Parameter 4	Parameter 5	Parameter 6	Parameter 7	Parameter 8	Parameter 9	Parameter 10
Stereo	DryWet	-	Drive	Gain	LowEQ	HighEQ	-	-	-	-
Classic	DryWet	-	Drive	Gain	-	-	-	-	-	-
Distortion	DryWet	-	Drive	Gain	-	-	-	-	-	-

11. EQ / Filter

Variation	Parameter 1	Parameter 2	Parameter 3	Parameter 4	Parameter 5	Parameter 6	Parameter 7	Parameter 8	Parameter 9	Parameter 10
4-BandEQ	Gain	-	LowGain	Mid1Gain	Mid1Q	Mid1Freq.	HighGain	Mid2Gain	Mid2Q	Mid2Freq.
7-BandEQ	Gain	-	100Hz	200Hz	400Hz	800Hz	1.6kHz	3.2kHz	6.4kHz	-
Standerd	Gain	-	Low	Mid	High	MidFreq.	-	-	-	-
Enhancer	DryWet	Depth	-	-	-	-	-	-	-	-
10-PoleFlt	DryWet	Freq.	TouchSens.	Gain	Lpf/Hpf	-	-	-	-	-

EFX Categories, Types, & Parameters

12. Rotary

Variation	Parameter 1	Parameter 2	Parameter 3	Parameter 4	Parameter 5	Parameter 6	Parameter 7	Parameter 8	Parameter 9	Parameter 10
Classic	Slow/Fast	-	LwrFastSpd	LwrSlowSpd	LwrAcc.Spd	Spread	UprFastSpd	UprSlowSpd	UprAcc.Spd	-
Warm	Slow/Fast	-	LwrFastSpd	LwrSlowSpd	LwrAcc.Spd	Spread	UprFastSpd	UprSlowSpd	UprAcc.Spd	-
Dirty	Drive	Gain	Slow/Fast	Depth	Acc.Speed	Spread	FastSpeed	SlowSpeed	LowEQ	HighEQ
+Vib/Cho	V/C type	Mode	Slow/Fast	Depth	Acc.Speed	Spread	FastSpeed	SlowSpeed	-	-
Single	Slow/Fast	Depth	FastSpeed	SlowSpeed	Acc.Speed	Spread	-	-	-	-

13. Groove

Variation	Parameter 1	Parameter 2	Parameter 3	Parameter 4	Parameter 5	Parameter 6	Parameter 7	Parameter 8	Parameter 9	Parameter 10
S/H Flg	DryWet	Speed	Depth	Feedback	Manual	Attack	PanDepth	-	-	-
S/H Pha	DryWet	Speed	Depth	Feedback	Manual	Attack	PanDepth	-	-	-
S/H Wah	DryWet	Speed	Depth	Feedback	Manual	Attack	PanDepth	-	-	-
S/H Pan	DryWet	Speed	PanDepth	Attack	-	-	-	-	-	-

14. Misc

Variation	Parameter 1	Parameter 2	Parameter 3	Parameter 4	Parameter 5	Parameter 6	Parameter 7	Parameter 8	Parameter 9	Parameter 10
RingMod	DryWet	Freq.	LowEQ	HighEQ	-	-	-	-	-	-
Lo-Fi	DryWet	ModSpeed	ModDepth	SampleRate	Resolution	Filter	-	-	-	-

15. Chorus+

Variation	Parameter 1	Parameter 2	Parameter 3	Parameter 4	Parameter 5	Parameter 6	Parameter 7	Parameter 8	Parameter 9	Parameter 10
Flanger	Cho:DryWet	Flg:DryWet	Cho:Speed	Cho:Depth	Cho:PreDly	Cho:Phase	Flg:Speed	Flg:Depth	Flg:F.Back	Flg:PreDly
Phaser	Cho:DryWet	Pha:DryWet	Cho:Speed	Cho:Depth	Cho:PreDly	Cho:Phase	Pha:Speed	Pha:Depth	Pha:Manual	Pha:Phase
Wah	Cho:DryWet	Wah:DryWet	Cho:Speed	Cho:Depth	Cho:PreDly	Cho:Phase	Wah:Sens.	Wah:Manual	-	-
Tremolo	Cho:DryWet	Trm:Depth	Cho:Speed	Cho:Depth	Cho:PreDly	Cho:Phase	Trm:Speed	-	-	-
AutoPan	Cho:DryWet	Pan:Depth	Cho:Speed	Cho:Depth	Cho:PreDly	Cho:Phase	Pan:Speed	-	-	-
Delay	Cho:DryWet	Dly:DryWet	Cho:Speed	Cho:Depth	Cho:PreDly	Cho:Phase	Dly:Time	Dly:F.Back	-	-

16. Phaser+

Variation	Parameter 1	Parameter 2	Parameter 3	Parameter 4	Parameter 5	Parameter 6	Parameter 7	Parameter 8	Parameter 9	Parameter 10
Chorus	Pha:DryWet	Cho:DryWet	Pha:Speed	Pha:Depth	Pha:Manual	Pha:Phase	Cho:Speed	Cho:Depth	Cho:PreDly	Cho:Phase
Flanger	Pha:DryWet	Flg:DryWet	Pha:Speed	Pha:Depth	Pha:Manual	Pha:Phase	Flg:Speed	Flg:Depth	Flg:F.Back	Flg:PreDly
Wah	Pha:DryWet	Wah:DryWet	Pha:Speed	Pha:Depth	Pha:Manual	Pha:Phase	Wah:Sens.	Wah:Manual	-	-
Tremolo	Pha:DryWet	Trm:Depth	Pha:Speed	Pha:Depth	Pha:Manual	Pha:Phase	Trm:Speed	-	-	-
AutoPan	Pha:DryWet	Pan:Depth	Pha:Speed	Pha:Depth	Pha:Manual	Pha:Phase	Pan:Speed	-	-	-
Delay	Pha:DryWet	Dly:DryWet	Pha:Speed	Pha:Depth	Pha:Manual	Pha:Phase	Dly:Time	Dly:F.Back	-	-

17. Wah+

Variation	Parameter 1	Parameter 2	Parameter 3	Parameter 4	Parameter 5	Parameter 6	Parameter 7	Parameter 8	Parameter 9	Parameter 10
Chorus	Wah:DryWet	Cho:DryWet	Wah:Sens.	Wah:Manual	-	-	Cho:Speed	Cho:Depth	Cho:PreDly	Cho:Phase
Flanger	Wah:DryWet	Flg:DryWet	Wah:Sens.	Wah:Manual	-	-	Flg:Speed	Flg:Depth	Flg:F.Back	Flg:PreDly
Phaser	Wah:DryWet	Pha:DryWet	Wah:Sens.	Wah:Manual	-	-	Pha:Speed	Pha:Depth	Pha:Manual	Pha:Phase
Tremolo	Wah:DryWet	Trm:Depth	Wah:Sens.	Wah:Manual	-	-	Trm:Speed	-	-	-
AutoPan	Wah:DryWet	Pan:Depth	Wah:Sens.	Wah:Manual	-	-	Pan:Speed	-	-	-
Delay	Wah:DryWet	Dly:DryWet	Wah:Sens.	Wah:Manual	-	-	Dly:Time	Dly:F.Back	-	-

18. EQ+

Variation	Parameter 1	Parameter 2	Parameter 3	Parameter 4	Parameter 5	Parameter 6	Parameter 7	Parameter 8	Parameter 9	Parameter 10
Chorus	EQ:Gain	Cho:DryWet	EQ:Low	EQ:Mid	EQ:High	EQ:MidFrq	Cho:Speed	Cho:Depth	Cho:PreDly	Cho:Phase
Flanger	EQ:Gain	Flg:DryWet	EQ:Low	EQ:Mid	EQ:High	EQ:MidFrq	Flg:Speed	Flg:Depth	Flg:F.Back	Flg:PreDly
Phaser	EQ:Gain	Pha:DryWet	EQ:Low	EQ:Mid	EQ:High	EQ:MidFrq	Pha:Speed	Pha:Depth	Pha:Manual	Pha:Phase
Wah	EQ:Gain	Wah:DryWet	EQ:Low	EQ:Mid	EQ:High	EQ:MidFrq	Wah:Sens.	Wah:Manual	-	-
Tremolo	EQ:Gain	Trm:Depth	EQ:Low	EQ:Mid	EQ:High	EQ:MidFrq	Trm:Speed	-	-	-
AutoPan	EQ:Gain	Pan:Depth	EQ:Low	EQ:Mid	EQ:High	EQ:MidFrq	Pan:Speed	-	-	-
Delay	EQ:Gain	Dly:DryWet	EQ:Low	EQ:Mid	EQ:High	EQ:MidFrq	Dly:Time	Dly:F.Back	-	-
Compressor	EQ:Gain	Cmp:Gain	EQ:Low	EQ:Mid	EQ:High	EQ:MidFrq	Cmp:Ratio	Cmp:Thresh	Cmp:Attack	Cmp:Rls

19. Enhancer+

Variation	Parameter 1	Parameter 2	Parameter 3	Parameter 4	Parameter 5	Parameter 6	Parameter 7	Parameter 8	Parameter 9	Parameter 10
Chorus	Enh:DryWet	Cho:DryWet	Enh:Depth	-	-	-	Cho:Speed	Cho:Depth	Cho:PreDly	Cho:Phase
Flanger	Enh:DryWet	Flg:DryWet	Enh:Depth	-	-	-	Flg:Speed	Flg:Depth	Flg:F.Back	Flg:PreDly
Phaser	Enh:DryWet	Pha:DryWet	Enh:Depth	-	-	-	Pha:Speed	Pha:Depth	Pha:Manual	Pha:Phase
Wah	Enh:DryWet	Wah:DryWet	Enh:Depth	-	-	-	Wah:Sens.	Wah:Manual	-	-
Tremolo	Enh:DryWet	Trm:Depth	Enh:Depth	-	-	-	Trm:Speed	-	-	-
AutoPan	Enh:DryWet	Pan:Depth	Enh:Depth	-	-	-	Pan:Speed	-	-	-
Delay	Enh:DryWet	Dly:DryWet	Enh:Depth	-	-	-	Dly:Time	Dly:F.Back	-	-
Compressor	Enh:DryWet	Cmp:Gain	Enh:Depth	-	-	-	Cmp:Ratio	Cmp:Thresh	Cmp:Attack	Cmp:Rls

20. Pitch Shift+

Variation	Parameter 1	Parameter 2	Parameter 3	Parameter 4	Parameter 5	Parameter 6	Parameter 7	Parameter 8	Parameter 9	Parameter 10
Flanger	Psh:DryWet	Flg:DryWet	Psh:Fine	Psh:Coarse	-	-	Flg:Speed	Flg:Depth	Flg:F.Back	Flg:PreDly
Phaser	Psh:DryWet	Pha:DryWet	Psh:Fine	Psh:Coarse	-	-	Pha:Speed	Pha:Depth	Pha:Manual	Pha:Phase
Wah	Psh:DryWet	Wah:DryWet	Psh:Fine	Psh:Coarse	-	-	Wah:Sens.	Wah:Manual	-	-
Tremolo	Psh:DryWet	Trm:Depth	Psh:Fine	Psh:Coarse	-	-	Trm:Speed	-	-	-
AutoPan	Psh:DryWet	Pan:Depth	Psh:Fine	Psh:Coarse	-	-	Pan:Speed	-	-	-
Delay	Psh:DryWet	Dly:DryWet	Psh:Fine	Psh:Coarse	-	-	Dly:Time	Dly:F.Back	-	-

EFX Categories, Types, & Parameters

21. Compressor+

Variation	Parameter 1	Parameter 2	Parameter 3	Parameter 4	Parameter 5	Parameter 6	Parameter 7	Parameter 8	Parameter 9	Parameter 10
Chorus	Cmp:Gain	Cho:DryWet	Cmp:Ratio	Cmp:Thresh	Cmp:Attack	Cmp:Rls	Cho:Speed	Cho:Depth	Cho:PreDly	Cho:Phase
Flanger	Cmp:Gain	Flg:DryWet	Cmp:Ratio	Cmp:Thresh	Cmp:Attack	Cmp:Rls	Flg:Speed	Flg:Depth	Flg:F.Back	Flg:PreDly
Phaser	Cmp:Gain	Pha:DryWet	Cmp:Ratio	Cmp:Thresh	Cmp:Attack	Cmp:Rls	Pha:Speed	Pha:Depth	Pha:Manual	Pha:Phase
Wah	Cmp:Gain	Wah:DryWet	Cmp:Ratio	Cmp:Thresh	Cmp:Attack	Cmp:Rls	Wah:Sens.	Wah:Manual	-	-
Tremolo	Cmp:Gain	Trm:Depth	Cmp:Ratio	Cmp:Thresh	Cmp:Attack	Cmp:Rls	Trm:Speed	-	-	-
AutoPan	Cmp:Gain	Pan:Depth	Cmp:Ratio	Cmp:Thresh	Cmp:Attack	Cmp:Rls	Pan:Speed	-	-	-
Delay	Cmp:Gain	Dly:DryWet	Cmp:Ratio	Cmp:Thresh	Cmp:Attack	Cmp:Rls	Dly:Time	Dly:F.Back	-	-
OverDrive	Cmp:Gain	Ovd:DryWet	Cmp:Ratio	Cmp:Thresh	Cmp:Attack	Cmp:Rls	Ovd:Drive	Ovd:Gain	-	-

22. Overdrive+

Variation	Parameter 1	Parameter 2	Parameter 3	Parameter 4	Parameter 5	Parameter 6	Parameter 7	Parameter 8	Parameter 9	Parameter 10
Chorus	Ovd:DryWet	Cho:DryWet	Ovd:Drive	Ovd:Gain	-	-	Cho:Speed	Cho:Depth	Cho:PreDly	Cho:Phase
Flanger	Ovd:DryWet	Flg:DryWet	Ovd:Drive	Ovd:Gain	-	-	Flg:Speed	Flg:Depth	Flg:F.Back	Flg:PreDly
Phaser	Ovd:DryWet	Pha:DryWet	Ovd:Drive	Ovd:Gain	-	-	Pha:Speed	Pha:Depth	Pha:Manual	Pha:Phase
Wah	Ovd:DryWet	Wah:DryWet	Ovd:Drive	Ovd:Gain	-	-	Wah:Sens.	Wah:Manual	-	-
Tremolo	Ovd:DryWet	Trm:Depth	Ovd:Drive	Ovd:Gain	-	-	Trm:Speed	-	-	-
AutoPan	Ovd:DryWet	Pan:Depth	Ovd:Drive	Ovd:Gain	-	-	Pan:Speed	-	-	-
Delay	Ovd:DryWet	Dly:DryWet	Ovd:Drive	Ovd:Gain	-	-	Dly:Time	Dly:F.Back	-	-
EQ	Ovd:DryWet	EQ :Gain	Ovd:Drive	Ovd:Gain	-	-	EQ :Low	EQ :Mid	EQ :High	EQ :MidFrq

23. Parallel

Variation	Parameter 1	Parameter 2	Parameter 3	Parameter 4	Parameter 5	Parameter 6	Parameter 7	Parameter 8	Parameter 9	Parameter 10
Cho Flg	Cho:DryWet	Flg:DryWet	Cho:Speed	Cho:Depth	Cho:PreDly	Cho:Phase	Flg:Speed	Flg:Depth	Flg:F.Back	Flg:PreDly
Cho Pha	Cho:DryWet	Pha:DryWet	Cho:Speed	Cho:Depth	Cho:PreDly	Cho:Phase	Pha:Speed	Pha:Depth	Pha:Manual	Pha:Phase
Cho Wah	Cho:DryWet	Wah:DryWet	Cho:Speed	Cho:Depth	Cho:PreDly	Cho:Phase	Wah:Sens.	Wah:Manual	-	-
Cho Trm	Cho:DryWet	Trm:Depth	Cho:Speed	Cho:Depth	Cho:PreDly	Cho:Phase	Trm:Speed	-	-	-
Cho Pan	Cho:DryWet	Pan:Depth	Cho:Speed	Cho:Depth	Cho:PreDly	Cho:Phase	Pan:Speed	-	-	-
Cho Dly	Cho:DryWet	Dly:DryWet	Cho:Speed	Cho:Depth	Cho:PreDly	Cho:Phase	Dly:Time	Dly:F.Back	-	-

Specifications

■ Kawai MP11 Stage Piano

Keyboard	88 wooden keys with Ivory Touch key surfaces Grand Feel (GF) action with Let-off	
Sound Source	Harmonic Imaging™ XL (HI-XL), 88-key piano sampling	
No. of Sounds	40 voices (PIANO x 12, E.PIANO x 12, SUB x 16)	
Polyphony	max. 256 notes	
Keyboard Modes	Full Keyboard, Upper Split, Lower Split, Zone (adjustable split point/zone range)	
Sections	Internal:	PIANO, E.PIANO, SUB
	External:	MIDI (ZONE1, ZONE2, ZONE3, ZONE4)
Reverb	Types:	6 types (Room, Lounge, Small Hall, Concert Hall, Live Hall, Cathedral)
	Parameters:	PreDelay, Reverb Time, Reverb Depth
Effects	Types:	129 types (23 categories)
	Parameters:	Up to 10 parameters, depending on effect type
Amp Simulator <small>E.PIANO ONLY</small>	Types:	5 types (S. Case, M. Stack, J. Combo, F. Bass, L. Cabi)
	Parameters:	Drive, Level, Amp EQ Lo, Amp EQ Mid, Amp EQ Hi, Mid Frequency, Mic Type, Mic Position, Ambience
Virtual Technician	Touch Curve:	6 types (Light+, Light, Normal, Heavy, Heavy+, Off), User1~5
	Parameters:	PIANO: Voicing, Stereo Width, String Resonance, Damper Resonance, Key-off Effect, Damper Noise, Hammer Delay, Fall-back Noise, Topboard, Brilliance E.PIANO/SUB: Key-off Noise, Key-off Delay
	Temperament & Tuning:	7 types (Equal, Pure Major/Minor, Pythagorean, Meantone, Werkmeister, Kirnberger), User1~2 Fine Tune, Stretch Tuning, Key of Temperament
EQ	4-band equalizer (Low Gain, Mid1 Gain, Mid1 Q, Mid1 Freq., Mid2 Gain, Mid2 Q, Mid2 Freq., High Gain)	
Recorder	Internal:	10 songs – approximately 90,000 note memory capacity Transpose song, Convert song to Audio, Load SMF, Save SMF
	Audio:	Play MP3/WAV, Save MP3/WAV, Overdub, Recorder Gain
Metronome	Click:	1/4, 2/4, 3/4, 4/4, 5/4, 3/8, 6/8, 7/8, 9/8, 12/8
	Rhythm:	100 drum patterns
Internal Memories	SOUND:	40 memories
	SETUP:	208 memories (8 memories x 26 banks)
	POWERON:	1 memory
USB Functions	Load/Save:	One Sound, One Setup, SMF, All Sound, All Setup, All Backup
	Others:	Delete, Rename, Format
EDIT Menu	Sound Sections:	98 parameters (Reverb, EFX/AMP, Sound, Tuning, Key Setup, Controllers, Knob Assign, Virtual Tech.)
	MIDI Zones:	62 parameters (Channel/Program, SETUP, Transmit, MMC, Key Setup, Controllers, Knob Assign)
SYSTEM Menu	50 parameters and functions (Utility, Pedal, MIDI, Offset, User Edit, Reset)	
Display	128 x 64 pixel LCD with backlight	
Panel Controls	Volume, Line In, PIANO Volume, E.PIANO Volume, SUB Volume, Control Knobs A~D (assignable), Pitch Bend, Modulation	
Jacks	Output:	1/4" LINE OUT (L/MONO, R), XLR OUT (L, R) with ground lift switch, Headphones
	Input:	1/4" LINE IN
	MIDI & USB:	MIDI IN, MIDI OUT, MIDI THRU, USB to Host, USB to Device
	Foot Control:	DAMPER/SOST. SOFT (for F-30), EXP
	Power:	AC IN
Power Consumption	20 W	
Dimensions	1380 (W) x 453 (D) x 188 (H) mm / 54 1/2" (W) x 18" (D) x 7 1/2" (H)	
Weight	32.5 kg / 71 1/2 lbs.	
Included Accessories	F-30 triple pedal unit (with half-damper support), Music rest, Power cable, Owner's manual	

Specifications are subject to change without notice.

1. Recognised data

- 1.1 Channel Voice Message
- 1.2 Channel Mode Message
- 1.3 System Realtime Message

2. Transmitted data

- 2.1 Channel Voice Message
- 2.2 Channel Mode Message
- 2.3 System Realtime Message

3. Exclusive data

- 3.1 MMC Commands
- 3.2 Parameter Send
- 3.3 Setup Address: Global Section
- 3.4 Setup Address: Internal Section
- 3.5 Setup Address: MIDI Section
- 3.6. Internal Section's Assignable Knob Data

4. SOUND/SETUP Program/Bank

5. Control Change Number (CC#) Table

MIDI Implementation Chart

1 Recognised Data

1.1 Channel Voice Message

Note off

Status	2nd Byte	3rd Byte
8nH	kkH	vvH
9nH	kkH	00H
n=MIDI channel number		:0H-fH(ch.1 ~ ch.16)
kk=Note Number		:00H - 7fH(0 ~ 127)
vv=Velocity		:00H - 7fH(0 ~ 127)

Note on

Status	2nd Byte	3rd Byte
9nH	kkH	vvH
n=MIDI channel number		:0H-fH(ch.1 ~ ch.16)
kk=Note Number		:00H - 7fH(0 ~ 127)
vv=Velocity		:00H - 7fH(0 ~ 127)

Control Change Bank Select (MSB)

Status	2nd Byte	3rd Byte
BnH	00H	mmH
BnH	20H	llH
n=MIDI channel number		:0H-fH(ch.1 ~ ch.16)
mm = Bank Number MSB		:00H-7fH (0 ~ 127)
ll = BankNumber LSB		:00H-7fH (0 ~ 127)

Modulation

Status	2nd Byte	3rd Byte
BnH	01H	vvH
n=MIDI channel number		:0H-fH(ch.1 ~ ch.16)
vv = Modulation depth		:00H - 7fH(0 ~ 127) Default = 00H

Data Entry

Status	2nd Byte	3rd Byte
BnH	06H	mmH
BnH	26H	llH
n=MIDI channel number		:0H-fH(ch.1 ~ ch.16)
mm,ll=Value indicated in RPN/NRPN *see RPN/NRPN chapter		:00H - 7fH(0 ~ 127)

Volume

Status	2nd Byte	3rd Byte
BnH	07H	vvH
n=MIDI channel number		:0H-fH(ch.1 ~ ch.16)
vv=Volume		:00H - 7fH(0 ~ 127) Default = 7fH

Panpot

Status	2nd Byte	3rd Byte
BnH	0aH	vvH
n=MIDI channel number		:0H-fH(ch.1 - ch.16)
vv=Panpot		:00H - 40H - 7fH(left ~centre~right) Default = 40H(centre)

1.1 Channel Voice Message (cont.)

Expression			
Status	2nd Byte	3rd Byte	
BnH	0bH	vvH	
n=MIDI channel number		:0H-fH(ch.1 - ch.16)	
vv=Expression		:00H - 7fH(0 - 127)	Default = 7fH
Damper Pedal			
Status	2nd Byte	3rd Byte	
BnH	40H	vvH	
n=MIDI channel number		:0H-fH(ch.1 ~ ch.16)	
vv=Control Value		:00H - 7fH(0 ~ 127)	Default = 00H
0 - 63=OFF, 64 - 127=ON			
Sostenuto Pedal			
Status	2nd Byte	3rd Byte	
BnH	42H	vvH	
n=MIDI channel number		:0H-fH(ch.1 ~ ch.16)	
vv=Control Value		:00H - 7fH(0 ~ 127)	Default = 00H
0 - 63 =OFF, 64 - 127=ON			
Soft Pedal			
Status	2nd Byte	3rd Byte	
BnH	43H	vvH	
n=MIDI channel number		:0H-fH(ch.1 ~ ch.16)	
vv=Control Value		:00H - 7fH(0 ~ 127)	Default = 00H
0 - 63 =OFF, 64 - 127=ON			
Sound controllers #1-9			
Status	2nd Byte	3rd Byte	
BnH	46H	vvH	Sustain Level
BnH	47H	vvH	Resonance
BnH	48H	vvH	Release time
BnH	49H	vvH	Attack time
BnH	4aH	vvH	Cutoff
BnH	4bH	vvH	Decay time
BnH	4cH	vvH	Vibrato Rate
BnH	4dH	vvH	Vibrato Depth
BnH	4eH	vvH	Vibrato Delay
n=MIDI channel number		:0H-fH(ch.1 ~ ch.16)	
vv=Control Value		:00H - 7fH(-64 ~ 0 ~ +63)	Default = 40H
Effect Control			
Status	2nd Byte	3rd Byte	
BnH	5bH	vvH	Reverb depth
n=MIDI channel number		:0H-fH(ch.1 ~ ch.16)	
vv = Control Value		:00H - 7fH(0 ~ 127)	

1.1 Channel Voice Message (cont.)

RPN MSB/LSB

Status	2nd Byte	3rd Byte
BnH	63H	mmH
BnH	62H	llH
n=MIDI channel number		:0H-fH(ch.1 ~ ch.16)
mm=MSB of the NRPN parameter number		
ll=LSB of the NRPN parameter number		

NRPN numbers implemented in MP11 are as follows

NRPN # Data

MSB	LSB	MSB	Function & Range		
01H	08H	mmH	Vibrato Rate mm	:00H - 7FH(-64 ~ 0 ~ +63)	Default = 40H
01H	09H	mmH	Vibrato Depth mm	:00H - 7FH(-64 ~ 0 ~ +63)	Default = 40H
01H	0aH	mmH	Vibrato Delay mm	:00H - 7FH(-64 ~ 0 ~ +63)	Default = 40H
01H	20H	mmH	Cutoff mm	:00H - 7FH(-64 ~ 0 ~ +63)	Default = 40H
01H	21H	mmH	Resonance mm	:00H - 7FH(-64 ~ 0 ~ +63)	Default = 40H
01H	63H	mmH	Attack time mm	:00H - 7FH(-64 ~ 0 ~ +63)	Default = 40H
01H	64H	mmH	Decay time mm	:00H - 7FH(-64 ~ 0 ~ +63)	Default = 40H
01H	66H	mmH	Release time mm	:00H - 7FH(-64 ~ 0 ~ +63)	Default = 40H

* Ignoring the LSB of data Entry

* It is not affected in case of modifying cutoff if tone does not use the DCF.

RPN MSB/LSB

Status	2nd Byte	3rd Byte
BnH	65H	mmH
BnH	64H	llH
n=MIDI channel number		:0H-fH(ch.1 ~ ch.16)

mm=MSB of the RPN parameter number

ll=LSB of the RPN parameter number

RPN number implemented in MP11 are the followings

RPN # Data

MSB	LSB	MSB	LSB	Function & Range	
00H	00H	mmH	llH	Pitch bend sensitivity	
		mm	ll	:00H-0cH (0~12 [half tone]),ll:00H	Default=02H
00H	01H	mmH	llH	Master fine tuning	
		mm, ll		:20 00H - 40 00H - 60 00H (-8192x50/8192 ~ 0 ~ +8192x50/8192 [cent])	
7fH	7fH	--	--	RPN NULL	

Program Change

Status	2nd Byte
CnH	ppH

n=MIDI channel number :0H-fH(ch.1 ~ ch.16)

pp=Program number :00H - 7fH(0 ~ 127) Default = 00H

Pitch Bend Change

Status	2nd Byte	3rd Byte
EnH	llH	mmH

n=MIDI channel number :0H-fH(ch.1 ~ ch.16)

mm, ll=Pitch bend value :00 00-7f 7fH(-8192~0~+8192) Default = 40 00H

1.2 Channel Mode Message

All Sound OFF

Status	2nd Byte	3rd Byte
BnH	78H	00H

n=MIDI channel number :0H-fH(ch.1 ~ ch.16)

Reset All Controller

Status	2nd Byte	3rd Byte
BnH	79H	00H

n=MIDI channel number :0H-fH(ch.1 ~ ch.16)

All Note Off

Status	2nd Byte	3rd Byte
BnH	7bH	00H

n=MIDI channel number :0H-fH(ch.1 ~ ch.16)

1.3 System Realtime Message

Status	
FEH	Active sensing

2 Transmitted Data

2.1 Channel Voice Message

Note off

Status	2nd Byte	3rd Byte
8nH	kkH	vvH
n=MIDI channel number		:0H-fH(ch.1 ~ ch.16)
kk=Note Number		:00H - 7fH(0 ~ 127)
vv=Velocity		:00H - 7fH(0 ~ 127)

Note on

Status	2nd Byte	3rd Byte
9nH	kkH	vvH
n=MIDI channel number		:0H-fH(ch.1 ~ ch.16)
kk=Note Number		:00H - 7fH(0 ~ 127)
vv=Velocity		:00H - 7fH(0 ~ 127)

Control Change

Status	2nd Byte	3rd Byte
BnH	ccH	vvH

* Sending by Assignable Control Knobs

Program Change

Status	2nd Byte	
CnH	ppH	
n=MIDI channel number		:0H-fH(ch.1 ~ ch.16)
pp=Program number		:00H - 7fH(0 ~ 127) Default = 00H

After Touch

Status	2nd Byte	
DnH	ppH	
n=MIDI channel number		:0H-fH(ch.1 ~ ch.16)
pp=Value		
*Sending only when Controller or Knob=AfterTouch		

Pitch Bend Change

Status	2nd Byte	3rd Byte
EnH	llH	mmH
n=MIDI channel number		:0H-fH(ch.1 ~ ch.16)
mm,ll=Pitch bend value		:00 00-7f 7fH(-8192~-0~+8192) Default = 40 00H

2.2 Channel Mode Message

Reset All Controller

Status	2nd Byte	3rd Byte
BnH	79H	00H

n = MIDI channel number :0H-fH(ch.1 ~ ch.16)
*Sending by [PANIC] function

All Note Off

Status	2nd Byte	3rd Byte
BnH	7bH	00H

n = MIDI channel number :0H-fH(ch.1 ~ ch.16)
*Sending by [PANIC] function

MONO

Status	2nd Byte	3rd Byte
BnH	7eH	mmH

n=MIDI channel number :0H-fH(ch.1 ~ ch.16)
mm=mono number :01H(M=1)

POLY

Status	2nd Byte	3rd Byte
BnH	7fH	00H

n=MIDI channel number :0H-fH(ch.1 ~ ch.16)

2.3 System Realtime Message

Status

FAH	Start
FBH	Continue
FCH	Stop

*Sending by [RECORDER CONTROL] buttons

3 Exclusive Data

3.1 MMC Commands

No.	Description	Value	Notes
1	Exclusive	F0H	
2	Universal Real Time	7FH	
3	Device ID	0-7FH	
4	MMC command	06H	
5	Command Number	01-0DH	* see table right
6	EOX	F7H	

*Sending by [RECORDER CONTROL] buttons

*Transmit only

MMC Commands			
01	STOP	08	RECORD PAUSE
02	PLAY	09	PAUSE
03	DEFERRED PLAY	0A	EJECT
04	FAST FORWARD	0B	CHASE
05	REWIND	0C	COMMAND ERROR RESET
06	RECORD STROBE	0D	MMC RESET
07	RECORD EXIT		

3.2 Parameter Send

No.	Description	Value	Notes
1	Exclusive	F0H	
2	KAWAI ID	40H	
3	Channel no.	0nH n=0-FH	
4	Function no.	10H	Parameter Send
5	Group no.	00H	MI Group ID
6	Machine no.	12H	MP11 Machine ID
7	data1	40H	Setup Parameter
8	data2	0-7fH	Address MSB
9	data3	0-7fH	Address LSB
10	data4	0-7fH	data size (byte) max=128 byte
11	data5~	data max 128byte	
12	EOX	F7H	

3.3 Setup Address: Global Section

Category	Parameter	Address MSB/LSB (HEX)	Byte	Value (HEX)
SETUP	Setup Mode On/Off	00/49	1	00,01 (Off, On)
	SETUP Bank / Variation	00/19	2	Bank=00-19 (A~Z), Vari=00~07 (1~8)
GLOBAL	Global EQ Switch	00/1B	1	00,01(Off, On)
	Global EQ Low Gain	00/1C	1	36-40-4A (-10~+0~+10 dB)
	Global EQ High Gain	00/1D	1	36-40-4A (-10~+0~+10 dB)
	Global EQ Mid1 Gain	00/1E	1	36-40-4A (-10~+0~+10 dB)
	Global EQ Mid2 Gain	00/1F	1	36-40-4A (-10~+0~+10 dB)
	Global EQ Mid1 Q	00/20	1	00-06 (0.5~4.0)
	Global EQ Mid2 Q	00/22	1	00-06 (0.5~4.0)
	Global EQ Mid1 Frequency	00/21	1	00-7F (200~3150Hz)
	Global EQ Mid2 Frequency	00/23	1	00-7F (200~3150Hz)
	Transpose Switch	00/3D	1	00,01 (Off,On)
	Transpose Value	00/3E	1	28-40-58 (-24~0~+24)

3.4 Setup Address: Internal Section

Category	Parameter	Address MSB/LSB (HEX)			Byte	Value (HEX)
		PIANO	E.PIANO	SUB		
Buttons	Part Switch	00/5E	02/02	02/26	1	00,01 (Off, On)
	Volume Fader	01/70	02/14	04/38	1	00-7F
	Tone Number	00/60	02/04	03/28	2	00/00 - 00/0B (PIANO), 00/0C - 00/17 (E.PIANO), 00/18 - 00/27 (SUB)
1. REVERB	REVERB Switch	01/27	02/4B	03/6F	1	00,01 (Off, On)
	Reverb Type	00/24			1	00-05 (Room, Lounge, Small Hall, Concert Hall, Live Hall, Catedral)
	Reverb Pre Delay	00/26			1	00-7F
	Reverb Time	00/25			1	00-7F
	Reverb Depth	01/28	02/4C	03/70	1	00-7F
2. EFX/AMP	EFX Switch	01/0D	02/31	03/55	1	00,01 (Off, On)
	EFX Category	01/0E	02/32	03/56	1	00-16
	EFX Type	01/0F	02/33	03/57	1	*depend on EFX Category
	EFX Parameter 1	01/10	02/34	03/58	1	*depend on EFX Type
	EFX Parameter 2	01/11	02/35	03/59	1	*depend on EFX Type
	EFX Parameter 3	01/12	02/36	03/5A	1	*depend on EFX Type
	EFX Parameter 4	01/13	02/37	03/5B	1	*depend on EFX Type
	EFX Parameter 5	01/14	02/38	03/5C	1	*depend on EFX Type
	EFX Parameter 6	01/15	02/39	03/5D	1	*depend on EFX Type
	EFX Parameter 7	01/16	02/3A	03/5E	1	*depend on EFX Type
	EFX Parameter 8	01/17	02/3B	03/5F	1	*depend on EFX Type
	EFX Parameter 9	01/18	02/3C	03/60	1	*depend on EFX Type
	EFX Parameter 10	01/19	02/3D	03/61	1	*depend on EFX Type
	EFX2 Switch	-	02/3E	-	1	0,1 (Off, On)
	EFX2 Category	-	02/3F	-	1	00-16
	EFX2 Type	-	02/40	-	1	*depend on EFX2 Category
	EFX2 Parameter 1	-	02/41	-	1	*depend on EFX2 Type
	EFX2 Parameter 2	-	02/42	-	1	*depend on EFX2 Type
	EFX2 Parameter 3	-	02/43	-	1	*depend on EFX2 Type
	EFX2 Parameter 4	-	02/44	-	1	*depend on EFX2 Type
	EFX2 Parameter 5	-	02/45	-	1	*depend on EFX2 Type
	EFX2 Parameter 6	-	02/46	-	1	*depend on EFX2 Type
	EFX2 Parameter 7	-	02/47	-	1	*depend on EFX2 Type
	EFX2 Parameter 8	-	02/48	-	1	*depend on EFX2 Type
	EFX2 Parameter 9	-	02/49	-	1	*depend on EFX2 Type
	EFX2 Parameter 10	-	02/4A	-	1	*depend on EFX2 Type
	AMP Simulator Switch	-	02/16	-	1	0,1 (Off, On)
	AMP Simulator Type	-	02/17	-	1	0-4 (S.Case, M.Stack, J.Combo, F.Bass, L.Cabi)
	AMP Simulator Drive	-	02/19	-	1	0-7F
	AMP Simulator Level	-	02/18	-	1	0-7F
	AMP Simulator EQ Low	-	02/1B	-	1	00-0A-14 (-10~+0~+10dB)
	AMP Simulator EQ Mid	-	03/15	-	1	00-0A-14 (-10~+0~+10dB)
	AMP Simulator EQ Mid Freq.	-	03/16	-	1	0-7F (200~3150Hz)
AMP Simulator EQ High	-	02/1C	-	1	00-0A-14 (-10~+0~+10dB)	
AMP Simulator Mic Type	-	02/1D	-	1	00,01 (Condenser, Dynamic)	
AMP Simulator Mic Position	-	02/1E	-	1	00,01 (OnAxis, OffAxis)	
AMP Simulator Ambiance Level	-	02/1A	-	1	0-7F	

3.4 Setup Address: Internal Section (cont.)

Category	Parameter	Address MSB/LSB (HEX)			Byte	Value (HEX)
		PIANO	E.PIANO	SUB		
3. Sound	Volume	01/37	02/5B	02/7F	1	0-7F
	Panpot	01/38	02/5C	04/00	1	0-40-7F (L64~0~R63)
	Cutoff	01/39	02/5D	04/01	1	0-40-7F (-64~0~+63)
	Resonance	01/3A	02/5E	04/02	1	0-40-7F (-64~0~+63)
	DCA Attack Time	01/3B	02/5F	04/03	1	0-40-7F (-64~0~+63)
	DCA Decay Time	01/3C	02/60	04/04	1	0-40-7F (-64~0~+63)
	DCA Sustain Level	01/3D	02/61	04/05	1	0-40-7F (-64~0~+63)
	DCA Release Time	01/3E	02/62	04/06	1	0-40-7F (-64~0~+63)
	DCF Attack Time	01/3F	02/63	04/07	1	0-40-7F (-64~0~+63)
	DCF Attack Level	01/40	02/64	04/08	1	0-40-7F (-64~0~+63)
	DCF Decay Time	01/41	02/65	04/09	1	0-40-7F (-64~0~+63)
	DCF Sustain Level	01/43	02/67	04/0B	1	0-40-7F (-64~0~+63)
	DCF Release Time	01/42	02/66	04/0A	1	0-40-7F (-64~0~+63)
	DCF Touch Depth	01/44	02/68	04/0C	1	0-40-7F (-64~0~+63)
	DCA Touch Depth	01/45	02/69	04/0D	1	0-40-7F (-64~0~+63)
	Vibrato Depth	01/46	02/6A	04/0E	1	0-40-7F (-64~0~+63)
	Vibrato Rate	01/47	02/6B	04/0F	1	0-40-7F (-64~0~+63)
	Vibrato Delay	01/48	02/6C	04/10	1	0-40-7F (-64~0~+63)
	Octave Layer On/Off	01/49	02/6D	04/11	1	00,01 (Off, On)
	Octave Layer Level	01/4A	02/6E	04/12	1	0-7F
Octave Layer Range	01/4B	02/6F	04/13	1	3D-40-43 (-3~+0~+3)	
Octave Layer Detune	01/4C	02/70	04/14	1	0-40-7F (-64~0~+63)	
Layer Sound:Vocal	00/62	02/06	03/2A	1	0,1-7F (Off, 1~127)	
Layer Sound:Bell	00/63	02/08	03/2B	1	0,1-7F (Off, 1~127)	
Layer Sound:Air	00/64	02/08	03/2C	1	0,1-7F (Off, 1~127)	
4. Tuning	Fine Tune	00/7B	02/1F	03/43	1	0-40-7F (-64~0~+63)
	Stretch Tuning	00/7C	02/20	03/44	1	00-08 (Off, Narrow2, Narrow1, Normal, Wide1, Wide2~5)
	Temperament	00/7D	02/21	03/45	1	00-08 (Equal, PureMaj, PureMin, Pythagor, Meantone, Werkmeis, Kirnberg, Sys. User1~2)
	Temperament Key	00/7E	02/22	03/46	1	00-0B (C~B)
5. KeySetup	Key Range Mode	00/7F	02/23	03/47	1	00-03 (Off, Lower, Upper, Zone)
	Split Point		00/46		1	15-6C (A-1 ~ C7)
	Key Range - Zone Low	01/00	02/24	03/48	1	15-6C (A-1 ~ C7)
	Key Range - Zone High	01/01	02/25	03/49	1	15-6C (A-1 ~ C7)
	Octave Shift	01/09	02/2D	03/51	1	3D-40-43 (-3~0~+3)
	Touch Curve	01/04	02/28	03/4C	1	00-0A (Heavy+, Heavy, Normal, Light, Light+, Off, Sys.User1~5)
	Zone Transpose	01/0A	02/2E	03/52	1	34-40-4C (-12~0~+12)
	KS-Damping	01/0C	02/30	03/54	1	00,01 (Off, On)
	KS-Key	01/0B	02/2F	03/53	1	15-6C (A-1 ~ C7)
Dynamics	01/05	02/29	03/4D	1	00,01-0A (Off,1-10)	

3.4 Setup Address: Internal Section (cont.)

Category	Parameter	Address MSB/LSB (HEX)			Byte	Value(HEX)
		PIANO	E.PIANO	SUB		
6. Control	Right Pedal On/Off	01/2C	02/50	03/74	1	00,01 (Off, On)
	Right Pedal Assign	00/2E			1	00-11 (Mod., Pan., Exp., Damper, Soste., Soft, Reso., Cutoff, EFX1 Para1~10, EFX2 Para1~10)
	Soft Pedal Adjust	00/70	02/14	03/38	1	01-0A
	Damper Mode	01/2B	02/4F	03/73	1	00,01(Normal,Hold)
	Center Pedal On/Off	01/2E	02/52	03/76	1	00,01(Off, On)
	Center Pedal Assign	00/30			1	00-11 (Mod., Pan., Exp., Damper, Soste., Soft, Reso., Cutoff, EFX1 Para1~10, EFX2 Para1~10)
	Left Pedal On/Off	01/2F	02/53	03/77	1	00,01(Off, On)
	Left Pedal Assign	00/31			1	00-11 (Mod., Pan., Exp., Damper, Soste., Soft, Reso., Cutoff, EFX1 Para1~10, EFX2 Para1~10)
	PitchBend Wheel On/Off	01/33	02/57	03/7B	1	00,01(Off, On)
	PitchBend Range	01/34	02/58	03/7C	1	00-11 (Mod., Pan., Exp., Damper, Soste., Soft, Reso., Cutoff, EFX1 Para1~10, EFX2 Para1~10)
	Modulation Wheel On/Off	01/31	02/55	03/79	1	00,01(Off, On)
	Modulation Wheel Assign	01/32	02/56	03/7A	1	00-11 (Mod., Pan., Exp., Damper, Soste., Soft, Reso., Cutoff, EFX1 Para1~10, EFX2 Para1~10)
	EXP Pedal On/Off	01/30	02/54	03/78	1	00,01(Off, On)
EXP Pedal Assign	00/32			1	00-11 (Mod., Pan., Exp., Damper, Soste., Soft, Reso., Cutoff, EFX1 Para1~10, EFX2 Para1~10)	
7. KnobAsgn	KnobA Assign (1/2)	01/60	02/04	04/28	2	see 3.6: Internal Section's Assignable Knob Data
	KnobB Assign (1/2)	01/61	02/05	04/29	2	see 3.6: Internal Section's Assignable Knob Data
	KnobC Assign (1/2)	01/62	02/06	04/2A	2	see 3.6: Internal Section's Assignable Knob Data
	KnobD Assign (1/2)	01/63	02/07	04/2B	2	see 3.6: Internal Section's Assignable Knob Data
	KnobA Assign (2/2)	01/64	02/08	04/2C	2	see 3.6: Internal Section's Assignable Knob Data
	KnobB Assign (2/2)	01/65	02/09	04/2D	2	see 3.6: Internal Section's Assignable Knob Data
	KnobC Assign (2/2)	01/66	02/0A	04/2E	2	see 3.6: Internal Section's Assignable Knob Data
	KnobD Assign (2/2)	01/67	02/0B	04/2F	2	see 3.6: Internal Section's Assignable Knob Data
8. VirtTech	Voicing	00/65	-	-	1	00-05 (Normal, Mellow1, Mellow2, Dynamic, Bright1, Bright2)
	Stereo Width	00/66	-	-	1	00-7F
	String Resonance	00/67	-	-	1	00,01-0A (Off,1-10)
	Damper Resonance	00/68	-	-	1	00,01-0A (Off,1-10)
	KeyOff Effect	00/69	-	-	1	00,01-0A (Off,1-10)
	Damper Noise	00/6A	-	-	1	00,01-0A (Off,1-10)
	Hammer Delay	00/6B	-	-	1	00,01-0A (Off,1-10)
	Fallback Noise	00/6C	-	-	1	00,01-0A (Off,1-10)
	Topboard	00/6E	-	-	1	00-03 (Close, Open1~3)
	Brilliance	00/71	-	-	1	36-40-4A (-10~+0~+10dB)
	KeyoffNoise	-	02/10	02/34	1	00,01-0A (Off,1-10)
KeyOffNoiseDelay	-	02/11	02/35	1	00-7F	

3.5 Setup Address: MIDI Section

Sys-EX Parameters		Address MSB/LSB(HEX)				Byte	Value(HEX)
Category	Parameter	MIDI1	MIDI2	MIDI3	MIDI4		
Buttons	Part Switch	04/3C	04/74	05/2C	05/64	1	00,01 (Off, On)
1. Ch/Prog.	MIDI Transmit Channel	04/3D	04/75	05/2D	05/65	1	00-0F (1~16Ch)
	PGM Change Number	04/3E	04/76	05/2E	05/66	1	00-7F (1~128)
	Bank Number MSB	04/40	04/78	05/30	05/68	1	00-7F (0~127)
	Bank Number LSB	04/3F	04/77	05/2F	05/67	1	00-7F (0~127)
2. SETUP							
3. Transmit	*undefined	-	-	-	-	-	-
4. MMC							
5. KeySetup	Key Range Mode	04/41	04/79	05/31	05/69	1	00-03 (Off, Lower, Upper, Zone)
	Split Point	00/46				1	15-6C (A-1 ~ C7)
	Key Range - Zone Low	04/42	04/7A	05/32	05/6A	1	15-6C (A-1 ~ C7)
	Key Range - Zone High	04/43	04/7B	05/33	05/6B	1	15-6C (A-1 ~ C7)
	Octave Shift	04/4B	05/03	05/3B	05/73	1	3D-40-43 (-3~0~+3)
	Touch Curve	04/46	04/7E	05/36	05/6E	1	00-0A (Heavy+, Heavy, Normal, Light, Light+, Off, Sys. User1~5)
	Zone Transpose	04/4C	05/04	05/3C	05/74	1	34-40-4C (-12~0~+12)
	KS-Damping	04/4E	05/06	05/3E	05/76	1	00,01 (Off, On)
	KS-Key	04/4D	05/05	05/3D	05/75	1	15-6C (A-1 ~ C7)
	Dynamics	04/47	04/7F	05/37	05/6F	1	00,01-0A (Off,1-10)
	Solo On/Off	04/49	05/01	05/39	05/71	1	00,01 (Off, On)
	Solo Mode	04/4A	05/02	05/3A	05/72	1	00-02 (Last,High,Low)
6. Control	Right Pedal On/Off	04/50	05/08	05/40	05/78	1	00,01 (Off, On)
	Right Pedal Assign	00/34				1	00-77,78 (CC#0-119, AfterTouch)
	Half Pedal Range Low	04/6B	05/23	05/5B	06/13	1	00-7F
	Half Pedal Range High	04/6C	05/24	05/5C	06/14	1	00-7F
	Center Pedal On/Off	04/52	05/0A	05/42	05/7A	1	00,01 (Off, On)
	Center Pedal Assign	00/36				1	00-77,78 (CC#0-119, AfterTouch)
	Left Pedal On/Off	04/53	05/0B	05/43	05/7B	1	00,01 (Off, On)
	Left Pedal Assign	00/37				1	00-77,78 (CC#0-119, AfterTouch)
	PitchBend Wheel On/Off	04/57	05/0F	05/47	05/7F	1	00,01 (Off, On)
	PitchBend Range	04/58	05/10	05/48	06/00	1	00-0C
	Modulation Wheel On/Off	04/55	05/0D	05/45	05/7D	1	00,01 (Off, On)
	Modulation Wheel Assign	04/56	05/0E	05/46	05/7E	1	00-77,78 (CC#0-119, AfterTouch)
	EXP Pedal On/Off	04/54	05/0C	05/44	05/7C	1	00,01 (Off, On)
	EXP Pedal Assign	00/38				1	00-77,78 (CC#0-119, AfterTouch)
7. KnobAsgn	KnobA Assign (1/2)	04/5B	05/13	05/4B	06/03	2	00-77,78 (CC#0-119, AfterTouch)
	KnobB Assign (1/2)	04/5C	05/14	05/4C	06/04	2	00-77,78 (CC#0-119, AfterTouch)
	KnobC Assign (1/2)	04/5D	05/15	05/4D	06/05	2	00-77,78 (CC#0-119, AfterTouch)
	KnobD Assign (1/2)	04/5E	05/16	05/4E	06/06	2	00-77,78 (CC#0-119, AfterTouch)
	KnobA Assign (2/2)	04/5F	05/17	05/4F	06/07	2	00-77,78 (CC#0-119, AfterTouch)
	KnobB Assign (2/2)	04/60	05/18	05/50	06/08	2	00-77,78 (CC#0-119, AfterTouch)
	KnobC Assign (2/2)	04/61	05/19	05/51	06/09	2	00-77,78 (CC#0-119, AfterTouch)
	KnobD Assign (2/2)	04/62	05/1A	05/52	06/0A	2	00-77,78 (CC#0-119, AfterTouch)

3.6 Internal Section's Assignable Knob Data

Knob Assignable Parameter		Data (HEX)	Section		
Category	Name	1st / 2nd	PIANO	E.PIANO	SUB
1. REVERB	<input checked="" type="checkbox"/> ReverbType	00/01		o	
	<input checked="" type="checkbox"/> Rev.PreDly	00/02		o	
	<input checked="" type="checkbox"/> ReverbTime	00/03		o	
	ReverbDpth	00/04	o	o	o
2. EFX/AMP	EFX Categ.	00/05	o	o	o
	EFX Type	00/06	o	o	o
	EFX Para1	00/07	o	o	o
	EFX Para2	00/08	o	o	o
	EFX Para3	00/09	o	o	o
	EFX Para4	00/0A	o	o	o
	EFX Para5	00/0B	o	o	o
	EFX Para6	00/0C	o	o	o
	EFX Para7	00/0D	o	o	o
	EFX Para8	00/0E	o	o	o
	EFX Para9	00/0F	o	o	o
	EFX Para10	00/10	o	o	o
	EFX2 Categ.	00/11	x	o	x
	EFX2 Type	00/12	x	o	x
	EFX2 Para1	00/13	x	o	x
	EFX2 Para2	00/14	x	o	x
	EFX2 Para3	00/15	x	o	x
	EFX2 Para4	00/16	x	o	x
	EFX2 Para5	00/17	x	o	x
	EFX2 Para6	00/18	x	o	x
	EFX2 Para7	00/19	x	o	x
	EFX2 Para8	00/1A	x	o	x
	EFX2 Para9	00/1B	x	o	x
	EFX2 Para10	00/1C	x	o	x
	Amp Type	00/1D	x	o	x
	Amp Drive	00/1F	x	o	x
	Amp Level	00/1E	x	o	x
	AmpEQ-Lo	00/20	x	o	x
	AmpEQ-Mid	00/21	x	o	x
	AmpEQ-High	00/22	x	o	x
	MidFreq.	01/1A	x	o	x
AmpMicType	01/15	x	o	x	
AmpMicPos.	01/14	x	o	x	
AmpAmbien.	01/16	x	o	x	
3. Sound	Volume	00/23	o	o	o
	Panpot	00/24	o	o	o
	Cutoff	00/25	o	o	o
	Resonance	00/26	o	o	o
	DCA Attack	00/27	o	o	o
	DCA Decay	00/28	o	o	o
	DCA Sustain	00/29	o	o	o
	DCA Release	00/2A	o	o	o
	DCF ATK Tm	00/2B	o	o	o
	DCF ATK Lv	00/2C	o	o	o
	DCF Decay	00/2D	o	o	o
	DCFSustain	00/2F	o	o	o
	DCFRelease	00/2E	o	o	o
	DCF TchDpt	00/30	o	o	o
	DCA TchDpt	00/31	o	o	o

Knob Assignable Parameter		Data (HEX)	Section		
Category	Name	1st / 2nd	PIANO	E.PIANO	SUB
3. Sound	Vib.Depth	00/32	o	o	o
	Vib.Rate	00/33	o	o	o
	Vib.Delay	00/34	o	o	o
	Octave	00/35	o	o	o
	Oct.Level	00/36	o	o	o
	Oct.Range	00/37	o	o	o
	Oct.Detune	00/38	o	o	o
	Vocal	01/07	o	o	o
	Bell	01/08	o	o	o
	Air	01/19	o	o	o
4. Tuning	Fine Tune	00/4B	o	o	o
	Stretch	00/4C	o	o	o
	Temperment	00/4D	o	o	o
	Temper.Key	00/4E	o	o	o
5. KeySetup	KeyRange	00/4F	o	o	o
	<input checked="" type="checkbox"/> SpltPoint	00/50		o	
	Zone Lo	00/52	o	o	o
	Zone Hi	00/51	o	o	o
	OctavShift	00/57	o	o	o
	Touch	00/55	o	o	o
	ZoneTrans.	00/58	o	o	o
	KS-Damping	00/59	o	o	o
	KS-Key	00/5A	o	o	o
	Dynamics	00/5B	o	o	o
6. Control	Right Ped.	00/5E	o	o	o
	<input checked="" type="checkbox"/> R.Assign	00/5F		o	
	SoftPdIDpt	01/03	o	o	o
	Damp.Mode	00/60	o	o	o
	CenterPed.	00/63	o	o	o
	<input checked="" type="checkbox"/> C.Assign	00/64		o	
	Left Pedal	00/65	o	o	o
	<input checked="" type="checkbox"/> L.Assign	00/66		o	
	Pitch Bend	00/69	o	o	o
	Bend Range	00/6A	o	o	o
	Mod.Wheel	00/6B	o	o	o
	Mod.Assign	00/6C	o	o	o
	EXP Pedal	00/67	o	o	o
	<input checked="" type="checkbox"/> EXPAssign	00/68		o	
8. VirtTech	Voicing	00/79	o	x	x
	StereoWdth	00/7A	o	x	x
	StringReso	00/7B	o	x	x
	DamperReso	00/7C	o	x	x
	KeyOffEff.	00/7D	o	x	x
	DamperNois	00/7E	o	x	x
	HammerDly	00/7F	o	x	x
	FallbackNs	01/00	o	x	x
	Topboard	01/01	o	x	x
	HalfPdIAdj	01/02	o	x	x
	Brilliance	01/04	o	x	x
KeyOffNois	01/05	x	o	o	
KeyOffDly	01/06	x	o	o	

4 SOUND/SETUP Program/Bank

If the Receive Mode MIDI parameter is set to Panel (page 102), the MP11 receives MIDI data on the System Channel only. To change internal sounds via MIDI, please refer to the SOUND Program Number list below.

* Note: If the MP11 receives the Program Number from 1 to 128 and Bank number MSB 0 or 1 in the System Channel, the MP11 will switch to SETUP mode and the corresponding SETUP is recalled. When the Receive Mode is Section, the MP11 can be received to each internal sound sections individually.

Panel Mode:

SETUP Program Number

BANK#MSB	1:	SETUP mode ON
BANK#LSB	0-25:	BANK A-Z
PROGRAM	1-8:	Setup Variation 1-8

SOUND Program Number

BANK#MSB	0:	SETUP mode OFF
BANK#LSB	0:	PIANO Section
	1:	E.PIANO Section
	2:	SUB Section
PROGRAM	1-12:	PIANO/E.PIANO Section's Sound variation 1-12
	1-16:	SUB Section's Sound variation 1-16

* Only one sound section is activated.

Section Mode:

BANK#MSB	(ignored)
BANK#LSB	(ignored)
PROGRAM	1-12: PIANO/E.PIANO Section's Sound variation 1-12
	1-16: SUB Section's Sound variation 1-16

*For each section's Receive Channel.

*Not related to Setup ON/OFF.

5 Control Change Number (CC#) Table

Control Number		Control Function
Decimal	Hex	
0	0	Bank Select (MSB)
1	1	Modulation Wheel or lever
2	2	Breath Controller
3	3	(undefined)
4	4	Foot Controller
5	5	Portament Time
6	6	Data Entry (MSB)
7	7	Channel Volume
8	8	Balance
9	9	(undefined)
10	A	Panpot
11	B	Expression Controller
12	C	Effect Controller1
13	D	Effect Controller2
14	E	(undefined)
15	F	(undefined)
16-19	10-13	General Purpose Controller1~4
20-31	14-1F	(undefined)
32	20	Bank Select (LSB)
33-63	21-3F	(LSB of Control Number 1-32)
64	40	Hold1 (Damper Pedal or Sustain)
65	41	Portamento On/Off
66	42	Sostenuto
67	43	Soft Pedal
68	44	Legato Footswitch
69	45	Hold2 (freeze etc)
70	46	Sound Controller1 (Sound Variation)
71	47	Sound Controller2 (Filter Resonance/Harmonic Intensity)
72	48	Sound Controller3 (Release Time)
73	49	Sound Controller4 (Attack Time)
74	4A	Sound Controller5 (Brightness/Cutoff)
75	4B	Sound Controller6 (Decay Time)
76	4C	Sound Controller7 (Vibrato Rate)
77	4D	Sound Controller8 (Vibrato Depth)
78	4E	Sound Controller9 (Vibrato Delay)
79	4F	Sound Controller10
80-83	50-53	General Purpose Controller5~8
84	54	Portament Control
85-90	55-5A	(undefined)
91	5B	Effect1 Depth (Reverb Send Level)
92	5C	Effect2 Depth
93	5D	Effect3 Depth (Chorus Send Level)
94	5E	Effect4 Depth
95	5F	Effect5 Depth
96	60	Data Increment
97	61	Data Decrement
98	62	Non Registered Parameter Number (LSB)
99	63	Non Registered Parameter Number (MSB)
100	64	Registered Parameter Number (LSB)
101	65	Registered Parameter Number (MSB)
102-119	66-77	(undefined/reserved)
120-127	78-7F	Channel Mode Message

Function	Transmitted	Recognised		Remarks	
		Panel	Section		
Basic Channel	Default	1 - 16	1 - 16	1 - 16	
	Changed	1 - 16	1 - 16	1 - 16	
Mode	Default	3	3	3	
	Messages	3,4 (m=1)	X	X	
	Altered	*****			
Note Number	True Voice	0 - 127 *****	0 - 127	0 - 127	
Velocity	Note ON	0 9nH, v=1 - 127	0	0	
	Note OFF	0 8nH, v=0 - 127	0	0	
After Touch	Key	X	X	X	
	Channel	0 *1	X	X	
Pitch Bend		0	0	0	
Control Change	0,32	0	0	X	Bank Select
	1	0	0 *2	0	Modulation
	6,38	0	X	0	Data Entry
	7	0	X	0	Volume
	10	0	X	0	Panpot
	11	0	0 *2	0	Expression (EXP)
	64	0	0 *2	0	Hold1 (Damper)
	66	0	0 *2	0	Sostenuto (FootSW)
	67	0	0 *2	0	Soft
	70,71	0	X	0	Sustain, Resonance
	72,73,74,75	0	X	0	RLS, ATK, CTF, DCY
	76,77,78	0	X	0	Vibrato (Rate,Depth,Delay)
	91	0	X	0	Reverb Depth
	98,99	X	X	0	NRPN LSB/MSB
100, 101	X	X	0	RPN LSE/MSB	
0-119	0 *1	X	X		
Program Change	True #	0 *****	0 - 127	0 - 127	
System Exclusive		0	0	0	
Common	Song Position	X	X	X	
	Song Select	X	X	X	
	Tune	X	X	X	
System Real Time	Clock	X	X	X	
	Commands	0	X	X	
Other Functions	All Sound OFF	X	0	0	
	Reset All Cntrls	0	0	0	
	Local ON/OFF	X	X	X	
	All Note OFF	0	0 (123-127)	0 (123-127)	
	Active Sense	X	0	0	
	Reset	X	X	X	
Notes		*1: Assigned to Modulation Wheel, EXP, FootSW or Knob A~D *2: ON/OFF settings of each section are set in EDIT menu. The function is assigned to MOD/EXP/Right/Centre/Left Pedal in EDIT menu.			

Mode 1 : OMNI ON , POLY
Mode 3 : OMNI OFF, POLY

Mode 2 : OMNI ON , MONO
Mode 4 : OMNI OFF, MONO

0 : Yes
X : No

KAWAI

THE FUTURE OF THE PIANO

MP11 Owner's Manual
KPSZ-0671
OW1076E-J1414

