

Privia

ES

# PX-350M

## USER'S GUIDE GUÍA DEL USUARIO

Please keep all information for future reference.  
Guarde toda información para tener como referencia futura.

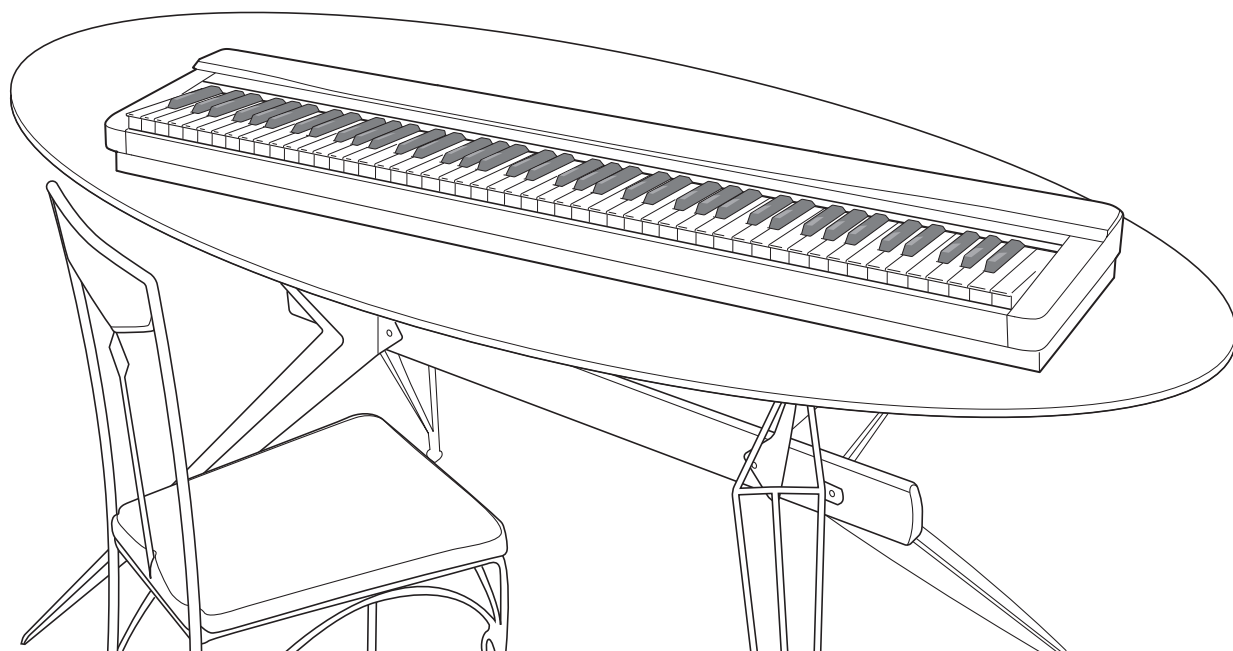

### **Safety Precautions**

Before trying to use the Digital Piano, be sure to read the separate "Safety Precautions".

### **Precauciones de seguridad**

Antes de intentar usar el piano digital, asegúrese de leer las "Precauciones de seguridad" separadas.

TO REDUCE THE RISK OF FIRE OR ELECTRIC SHOCK, REFER SERVICING TO QUALIFIED SERVICE PERSONNEL.

## IMPORTANT SAFETY INSTRUCTIONS

1. Read these instructions.
  2. Keep these instructions.
  3. Heed all warnings.
  4. Follow all instructions.
  5. Do not use this apparatus near water.
  6. Clean only with dry cloth.
  7. Do not block any ventilation openings. Install in accordance with the manufacturer's instructions.
  8. Do not install near any heat sources such as radiators, heat registers, stoves, or other apparatus (including amplifiers) that produce heat.
  9. Do not defeat the safety purpose of the polarized or grounding-type plug. A polarized plug has two blades with one wider than the other. A grounding type plug has two blades and a third grounding prong. The wide blade or the third prong are provided for your safety. If the provided plug does not fit into your outlet, consult an electrician for replacement of the obsolete outlet.
  10. Protect the power cord from being walked on or pinched particularly at plugs, convenience receptacles, and the point where they exit from the apparatus.
  11. Only use attachments/accessories specified by the manufacturer.
  12. Use only with the cart, stand, tripod, bracket, or table specified by the manufacturer, or sold with the apparatus. When a cart is used, use caution when moving the cart/apparatus combination to avoid injury from tip-over.
- 
13. Unplug this apparatus during lightning storms or when unused for long periods of time.
  14. Refer all servicing to qualified service personnel. Servicing is required when the apparatus has been damaged in any way, such as power-supply cord or plug is damaged, liquid has been spilled or objects have fallen into the apparatus, the apparatus has been exposed to rain or moisture, does not operate normally, or has been dropped.

The apparatus shall not be exposed to dripping or splashing and that no objects filled with liquids, such as vases, shall be placed on the apparatus.

The  (POWER) indicator being unlit does not mean the apparatus is completely disconnected from the MAINS. When you need to have the apparatus completely disconnected from the MAINS, you must unplug the power cord. For that purpose, locate the apparatus in a way that secures easy access to the power cord.

## Declaration of Conformity

Model Number: PX-350M

Trade Name: CASIO COMPUTER CO., LTD.

Responsible party: CASIO AMERICA, INC.

Address: 570 MT. PLEASANT AVENUE, DOVER, NEW JERSEY 07801

Telephone number: 973-361-5400

This device complies with Part 15 of the FCC Rules, Operation is subject to the following two conditions:

(1) This device may not cause harmful interference, and (2) this device must accept any interference received, including interference that may cause undesired operation.

## NOTICE

This equipment has been tested and found to comply with the limits for a Class B digital device, pursuant to Part 15 of the FCC Rules. These limits are designed to provide reasonable protection against harmful interference in a residential installation. This equipment generates, uses and can radiate radio frequency energy and, if not installed and used in accordance with the instructions, may cause harmful interference to radio communications. However, there is no guarantee that interference will not occur in a particular installation. If this equipment does cause harmful interference to radio or television reception, which can be determined by turning the equipment off and on, the user is encouraged to try to correct the interference by one or more of the following measures:

- Reorient or relocate the receiving antenna.
- Increase the separation between the equipment and receiver.
- Connect the equipment into an outlet on a circuit different from that to which the receiver is connected.
- Consult the dealer or an experienced radio/TV technician for help.

## FCC WARNING

Changes or modifications not expressly approved by the party responsible for compliance could void the user's authority to operate the equipment.

## Important!

Please note the following important information before using this product.

- Before using the AD-A12150LW Adaptor to power the product, be sure to check the AC Adaptor for any damage first. Carefully check the power cord for breakage, cuts, exposed wire and other serious damage. Never let children use an AC adaptor that is seriously damaged.
- The product is not intended for children under 3 years.
- Use only the CASIO AD-A12150LW adaptor.
- The AC adaptor is not a toy.
- Be sure to disconnect the AC adaptor before cleaning the product.

Declaration of Conformity According to EU Directive



This mark applies in EU countries only.



Manufacturer:  
CASIO COMPUTER CO., LTD.  
6-2, Hon-machi 1-chome, Shibuya-ku, Tokyo 151-8543, Japan

Responsible within the European Union:  
CASIO EUROPE GmbH  
Casio-Platz 1, 22848 Norderstedt, Germany

# Contents

## **General Guide..... E-2**

- Installing the Music Stand..... E-3
- Saving Settings and Using Panel Lock..... E-4
- Returning the Digital Piano to Its  
Factory Default Settings ..... E-4

## **Power Outlet ..... E-5**

- Using an AC Adaptor ..... E-5
- Turning Power On or Off..... E-5

## **Connections..... E-6**

- Connecting Headphones ..... E-6
- Connecting a Pedal ..... E-6
- Connecting Audio Equipment or an Amplifier ..... E-7
- Bundled and Optional Accessories..... E-8

## **Using Built-in Tones ..... E-9**

- Selecting a Tone..... E-9
- Layering Two Tones ..... E-9
- Splitting the Keyboard between Two Tones ..... E-10
- Using Octave Shift ..... E-11
- Adjusting the Brilliance of a Tone ..... E-12
- Adding Reverb to the Tone..... E-12
- Adding the Chorus Effect to the Tone..... E-13
- Using the Metronome ..... E-13
- Using the Pitch Bend Wheel ..... E-14
- Playing a Duet ..... E-15

## **Using Auto**

## **Accompaniment ..... E-17**

- Playing an Auto Accompaniment..... E-17
- Using One-Touch Presets ..... E-20
- Using Auto Harmonize ..... E-20
- Creating Your Own Original Rhythms..... E-21

## **Playing Demo Songs..... E-24**

- Playing Tone Demo Songs ..... E-24
- Listening to Songs Loaded  
from an External Source ..... E-25
- Playing Back Audio Data Stored  
on a USB Flash Drive ..... E-27

## **Music Presets ..... E-28**

- Selecting a Music Preset ..... E-28
- Creating an Original User Preset..... E-29

## **Registering Tone and Rhythm Setups..... E-33**

## **Recording Your Keyboard Play ..... E-35**

- Recording to Built-in Song Memory  
(Song Recorder)..... E-35
- Recording or Playing Back Multiple Songs ..... E-36
- Recording to a Specific Track (Part) ..... E-37
- Deleting Data Recorded with the Song Recorder ..... E-38
- Re-recording Part of a Recorder Song  
(Punch-in Recording) ..... E-39
- Recording to a USB Flash Drive (Audio Recorder) ... E-41

## **Other Settings..... E-43**

- Configuring Settings..... E-43

## **USB Flash Drive ..... E-47**

- Storing Standard Audio Data (WAV Files)  
to a USB Flash Drive..... E-48
- Connecting a USB Flash Drive to and  
Detaching It from the Digital Piano..... E-48
- Formatting a USB Flash Drive ..... E-49
- Saving Digital Piano Data to a USB Flash Drive..... E-49
- Loading Data from a USB Flash Drive to  
Digital Piano Memory ..... E-50
- Deleting Data from a USB Flash Drive..... E-51
- Renaming a USB Flash Drive File ..... E-51
- Playing Back a Song on a USB Flash Drive ..... E-52
- Error Messages..... E-53

## **Connecting to a Computer .... E-54**

- Minimum Computer System Requirements ..... E-54
- Connecting the Digital Piano to Your Computer ..... E-54
- Using MIDI ..... E-55
- Transferring Data between  
the Digital Piano and a Computer ..... E-55

## **Reference ..... E-58**

- Troubleshooting ..... E-58
- Product Specifications..... E-60
- Operating Precautions ..... E-62

## **Appendix ..... A-1**

- Tone List ..... A-1
- Drum Assignment List..... A-4
- Rhythm List ..... A-5
- Music Preset List..... A-7
- Fingering Guide..... A-9
- Chord Example List..... A-10

## **MIDI Implementation Chart**

Company and product names used in this manual may be registered trademarks of others.

# General Guide

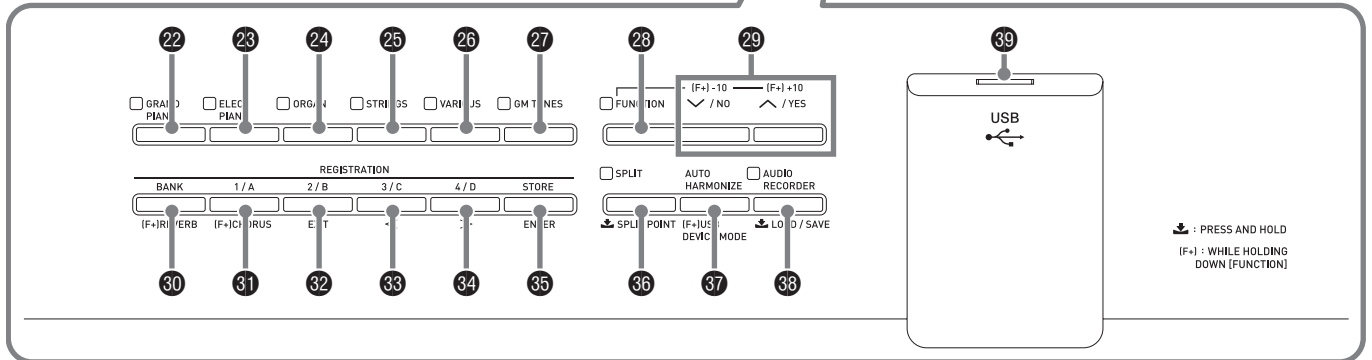
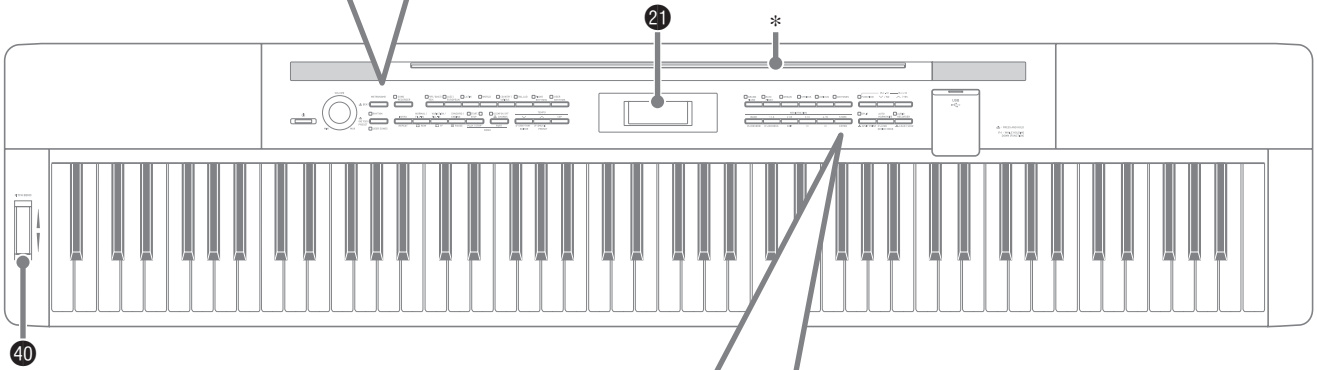
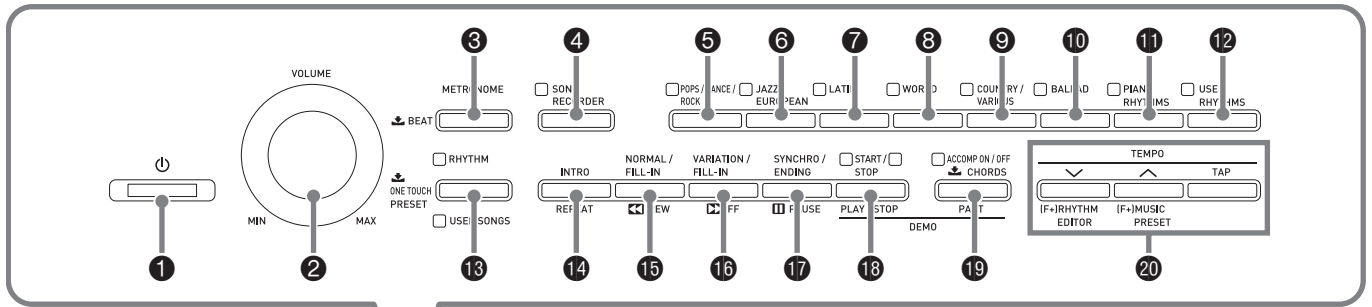

## Back

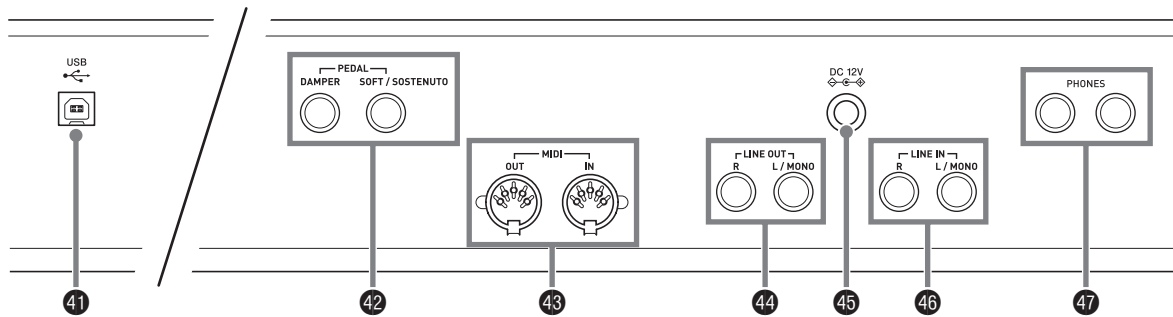

## Bottom

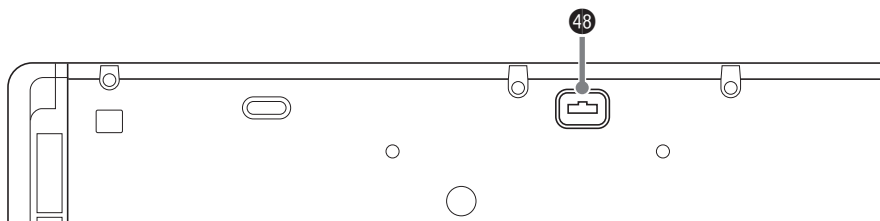

- This manual uses the numbers and names below to refer to buttons and controllers.

- ❶ **⏻ (POWER)** button
- ❷ **VOLUME** controller
- ❸ **METRONOME** button
- ❹ **SONG RECORDER** button
- ❺ **POPS/DANCE/ROCK** button
- ❻ **JAZZ/EUROPEAN** button
- ❼ **LATIN** button
- ❽ **WORLD** button
- ❾ **COUNTRY/VARIOUS** button
- ❿ **BALLAD** button
- ⓫ **PIANO RHYTHMS** button
- ⓬ **USER RHYTHMS** button
- ⓭ **RHYTHM, USER SONGS** button
- ⓮ **INTRO, REPEAT** button
- ⓯ **NORMAL/FILL-IN, ◀◀REW** button
- ⓰ **VARIATION/FILL-IN, ▶▶FF** button
- ⓱ **SYNCHRO/ENDING, PAUSE** button
- ⓲ **START/STOP, PLAY/STOP** button
- ⓳ **ACCOMP ON/OFF, PART** button
- ⓴ **TEMPO, RHYTHM EDITOR, MUSIC PRESET** buttons
- ⓵ Display
- ⓶ **GRAND PIANO** button
- ⓷ **ELEC PIANO** button
- ⓸ **ORGAN** button
- ⓹ **STRINGS** button
- ⓺ **VARIOUS** button
- ⓻ **GM TONES** button
- ⓼ **FUNCTION** button
- ⓽ **∨/NO, ∧/YES** buttons
- ⓾ **BANK, REVERB** button
- ⓿ **REGISTRATION 1/A, CHORUS** button
- ⓿ **REGISTRATION 2/B, EXIT** button
- ⓿ **REGISTRATION 3/C, <** button
- ⓿ **REGISTRATION 4/D, >** button
- ⓿ **STORE, ENTER** button
- ⓿ **SPLIT, SPLIT POINT** button
- ⓿ **AUTO HARMONIZE, USB DEVICE MODE** button
- ⓿ **AUDIO RECORDER, LOAD/SAVE** button
- ⓿ **USB** flash drive port
- ⓿ **PITCH BEND** wheel
- ⓿ **USB** port
- ⓿ **DAMPER, SOFT/SOSTENUTO PEDAL** jacks
- ⓿ **MIDI OUT/IN** terminals
- ⓿ **LINE OUT R, L/MONO** jacks
- ⓿ **DC 12V** terminal
- ⓿ **LINE IN R, L/MONO** jacks
- ⓿ **PHONES** jacks
- ⓿ Pedal connector

## \* Installing the Music Stand

Insert the bottom of the music stand into the groove on the top of the Digital Piano's console.

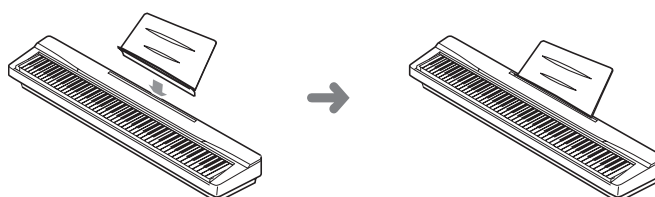

## Saving Settings and Using Panel Lock

Your Digital Piano lets you save its current settings, and lock its buttons to protect against operation errors. For details, see “Setting Backup” (page E-46) and “Panel Lock” (page E-46).

## Returning the Digital Piano to Its Factory Default Settings

Perform the following procedure when you want to return the Digital Piano’s stored data and settings to their initial factory defaults.

1. Turn off the Digital Piano.
2. While holding down both the **27 (GM TONES)** and **28 (FUNCTION)** buttons, press the **1 (⏻)** button.
  - The Digital Piano will turn on and initialize its internal system. You will be able to use the Digital Piano in a short while.

### NOTE

- See “Turning Power On or Off” (page E-5) for information about turning power on and off.

# Power Outlet

Your Digital Piano runs on standard household power. Be sure to turn off power whenever you are not using the Digital Piano.

## Using an AC Adaptor

Use only the AC adaptor (JEITA Standard, with unified polarity plug) that comes with this Digital Piano. Use of a different type of AC adaptor can cause malfunction of the Digital Piano.

**Specified AC Adaptor: AD-A12150LW**

- Use the supplied power cord to connect the AC adaptor as shown in the illustration below.

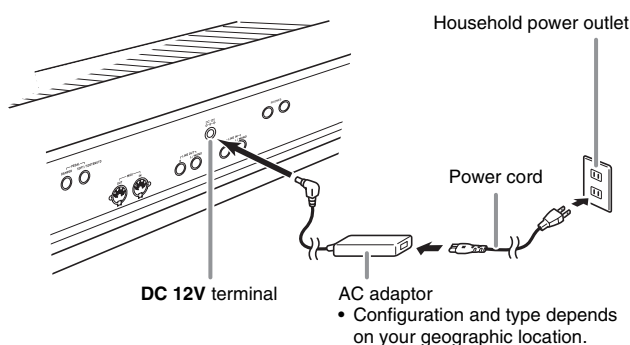

**Note the following important precautions to avoid damage to the power cord.**

### During Use

- Never pull on the cord with excessive force.
- Never repeatedly pull on the cord.
- Never twist the cord at the base of the plug or connector.

### During Movement

- Before moving the Digital Piano, be sure to unplug the AC adaptor from the power outlet.

### During Storage

- Loop and bundle the power cord, but never wind it around the AC adaptor.

### IMPORTANT!

- Never connect the AC adaptor (JEITA Standard, with unified polarity plug) that comes with this Digital Piano to any other device besides this Digital Piano. Doing so creates the risk of malfunction.
- Make sure the Digital Piano is turned off before plugging in or unplugging the AC adaptor.
- The AC adaptor will become warm to the touch after very long use. This is normal and does not indicate malfunction.

## Turning Power On or Off

1. Press the **1** (⏻) button to turn on Digital Piano power.
  - Do not touch the keyboard, pedal, or buttons while the "Please wait . . ." message is on the display. Doing so will cause malfunction.

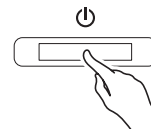

- Use the Digital Piano's VOLUME controller (**2**) to adjust the volume.

2. To turn off the Digital Piano, hold down the **1** (⏻) button until the Digital Piano's display goes blank.

### NOTE

- Pressing the **1** (⏻) button to turn off power actually puts the Digital Piano into a standby state. Minute amounts of current continue to flow within the Digital Piano in the standby state. If you do not plan to use the Digital Piano for a long time or if there is a lightning storm in your area, be sure to unplug the AC adaptor from the power outlet.

## Auto Power Off

This Digital Piano is designed to turn off automatically to avoid wasting power after no operation is performed for a preset amount of time. The Auto Power Off trigger time is about four hours.

- You also can use the procedure below to temporarily suspend Auto Power Off.

### ■ To disable Auto Power Off

1. While the Digital Piano is turned on, press the **1** (⏻) button to turn it off.
2. While holding down the **28** (FUNCTION) button, press the **1** (⏻) button to turn on the Digital Piano.

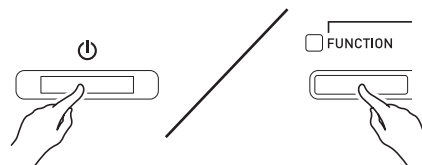

- Auto Power Off will be disabled at this time.

### NOTE

- Turning off the Digital Piano after performing the above steps will re-enable Auto Power Off.

# Connections

## Connecting Headphones

### IMPORTANT!

- Before connecting headphones, be sure to use the Digital Piano's **VOLUME** controller to turn the volume down to a low level. After connecting, you can adjust the volume to the level you want.
- The Digital Piano automatically adjusts sound output to optimize for headphones (when headphones are connected) or the built-in speakers (when headphones are not connected).

### Back

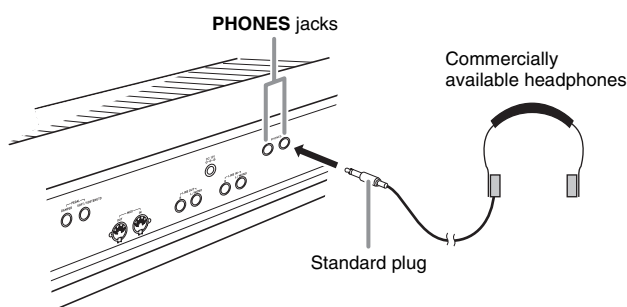

Connect commercially available headphones to the **PHONES** jacks. Connecting headphones to either of the **PHONES** jacks cuts off output to the speakers, which means you can practice even late at night without bothering others. To protect your hearing, make sure that you do not set the volume level too high when using headphones.

### NOTE

- Be sure to push the headphones plug into the **PHONES** jacks as far as it will go. If you don't, you may hear sound from only one side of the headphones.
- If the plug of the headphones you are using does not match the **PHONES** jacks, use the applicable commercially available adaptor plug.
- If you are using headphones that require an adaptor plug, make sure you do not leave the adaptor plugged in when you unplug the headphones. If you do, nothing will sound from the speakers when you play.

## Connecting a Pedal

The back of the Digital Piano has two pedal jacks, one for a damper pedal and one for a soft/sostenuto pedal.

### To connect to the pedal jack

Depending on the type of operation you want the pedal (SP-3) to perform, connect the pedal's cable either to the Digital Piano's **DAMPER PEDAL** jack or **SOFT/SOSTENUTO PEDAL** jack. If you want to use both operations (jacks) at the same time, you need to purchase another optionally available pedal.

### Back

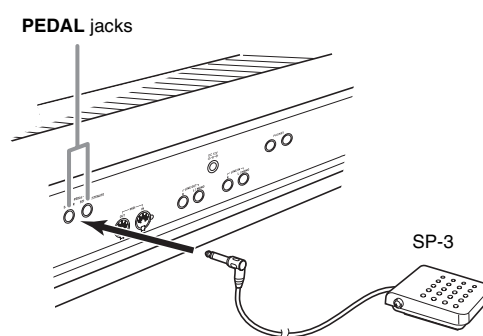

### NOTE

- You can connect a pedal to the **SOFT/SOSTENUTO PEDAL** jack and apply either a soft or sostenuto effect to the notes you play. For details, see "Soft/Sostenuto Pedal Jack Setting" (page E-46).

## Pedal Functions

### ● Damper Pedal

Pressing the damper pedal while playing will cause the notes you play to reverberate for a long time.

- Whenever a piano tone is selected, pressing this pedal will activate the Digital Piano's Damper Resonance effect, which causes notes to resonate in the same way they do when the damper pedal on an acoustic piano is pressed.

### ● Soft Pedal

Pressing this pedal suppresses notes played on the keyboard after the pedal was pressed, and makes them sound softer.

### ● Sostenuto Pedal

Only the notes that are played while this pedal are depressed are sustained until the pedal is released.



## Pedal Connector

You can connect the optionally available 3-Pedal Unit (SP-33) to the pedal connector on the bottom of the Digital Piano. You can then use the pedals for expression that is similar to that available on an acoustic piano.

### Bottom

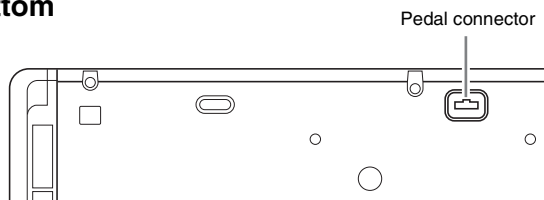

### NOTE

- The SP-33 Pedal Unit supports half-pedal operation (pressing the pedal part way). You can adjust the amount of the effect is applied when the damper pedal is pressed part way. For details, see “Half Pedal Effect” (page E-46).
- The optionally available CS-67P special stand is required in order to use the SP-33 Pedal Unit.

## Connecting Audio Equipment or an Amplifier

You can connect audio equipment or a music amplifier to the Digital Piano and then play through external speakers for more powerful volume and better sound quality.

### IMPORTANT!

- The Digital Piano automatically adjusts sound output to optimize for headphone output (when headphones are connected) or built-in speaker output (when headphones are not connected). This also will cause a change in the output quality from the Digital Piano's **LINE OUT R** and **L/MONO** jacks.
- Whenever connecting a device to the Digital Piano, first use the **VOLUME** controller to set the volume to a low level. After connecting, you can adjust the volume to the level you want.
- Whenever you connect any device to the Digital Piano, be sure to read the user documentation that comes with the device.

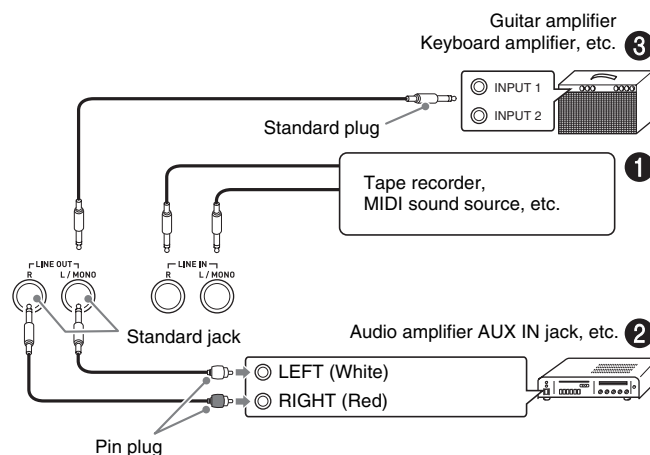

## Playing Output from External Equipment through the Digital Piano's Speakers ❶

Use commercially available cables to connect the external audio equipment to the Digital Piano's **LINE IN** jacks as shown in Figure ❶.

**LINE IN R** jack input sounds through the Digital Piano's right speaker, while **LINE IN L/MONO** jack input sounds through the left speaker. Connecting to the **LINE IN L/MONO** jack only causes the same output to be produced from both speakers. It is up to you to purchase connecting cables that are compatible with the equipment you are connecting.

## Connecting to Audio Equipment ❷

Use commercially available cables to connect the external audio equipment to the Digital Piano's **LINE OUT** jacks as shown in Figure ❷. **LINE OUT R** jack output is right channel sound, while **LINE OUT L/MONO** jack output is left channel sound. It is up to you to purchase connecting cables like the ones shown in the illustration for connection of audio equipment. Normally in this configuration you must set the audio equipment's input selector to the setting that specifies the terminal (such as AUX IN) to which the Digital Piano is connected. Use the Digital Piano's **VOLUME** controller to adjust the volume level.

## Connecting to a Musical Instrument Amplifier ❸

Use commercially available cables to connect the amplifier to the Digital Piano's **LINE OUT** jacks as shown in Figure ❸. **LINE OUT R** jack output is right channel sound, while **LINE OUT L/MONO** jack output is left channel sound. Connecting to the **LINE OUT L/MONO** jack only outputs a mixture of both channels. It is up to you to purchase connecting cable like the one shown in the illustration for connection of the amplifier. Use the Digital Piano's **VOLUME** controller to adjust the volume level.

### IMPORTANT!

- When using the **LINE OUT** jacks, also connect headphones to the **PHONES** jacks. This will switch the **LINE OUT** output to appropriate sound quality.

## Bundled and Optional Accessories

Use only accessories that are specified for use with this Digital Piano.

Use of unauthorized accessories creates the risk of fire, electric shock, and personal injury.

### NOTE

- You can get information about accessories that are sold separately for this product from the CASIO catalog available from your retailer, and from the CASIO website at the following URL.  
<http://world.casio.com/>

# Using Built-in Tones

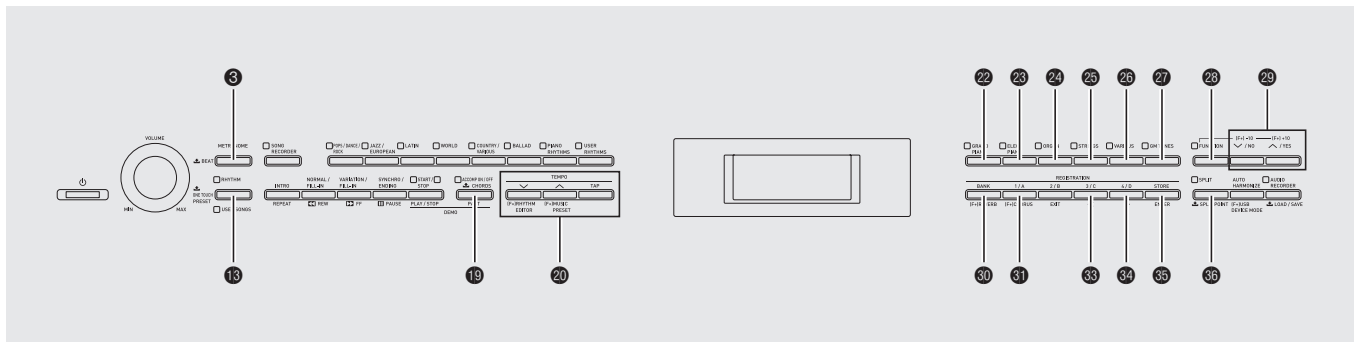

## Selecting a Tone

Your Digital Piano has 250 tones, divided into six groups.

- For more information, see the “Tone List” (page A-1).
- The Digital Piano has built-in demonstration tunes that highlight the different characteristics of tones. For more information, see “Playing Tone Demo Songs” (page E-24).

1. Use the “Tone List” (page A-1) to look up the group and the number of the tone you want to select.
2. Use the 22 to 27 (tone groups) buttons to select the group you want.

Example: To select the ORGAN group



3. Use the 29 (∨, ^) buttons to select the tone you want.

Example: To select “002 Jazz Organ”

Tone number

Tone name

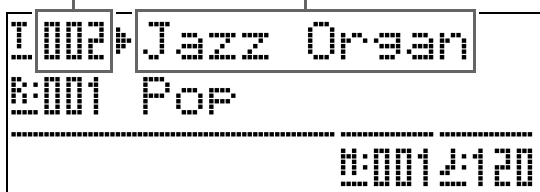

### NOTE

- Pressing ^ and ∨ at the same time will jump to tone 001 of the currently selected group. Holding down either button changes the tone number at high speed.
- See page E-43 for more information about scrolling.

## Layering Two Tones

You can layer two different tones so they play at the same time when you press a keyboard key.

- The first tone you select is called the “main tone”, while the second tone is called the “layered tone”.

1. Select the main tone.

Example: To select GRAND PIANO MELLOW in the GRAND PIANO group, press the 22 (GRAND PIANO) button and then use the 29 (∨, ^) buttons to select “006 GRAND PIANO MELLOW”.

- Hold down the button of the group that contains the tone you want to select as the layered tone until “LAYER ON” appears on the display as shown below for a few moments.

This will layer the tones currently selected in the two groups.

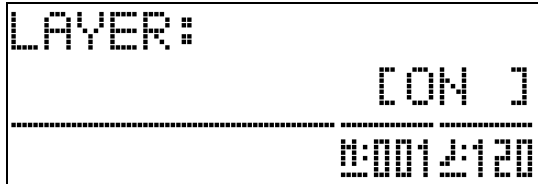

The button you held down in step 2 will light to indicate that it is selected.

*Example:* When VARIOUS group is selected

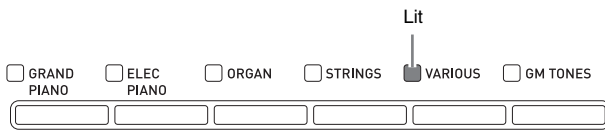

- Use the  $\text{29}$  ( $\nabla$ ,  $\wedge$ ) buttons to select the tone you want in the group you selected in step 2.

*Example:* When “006 Picked Bass” is selected

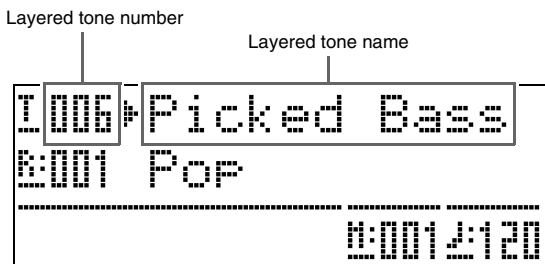

- To unlayer the tones and return the keyboard to a single tone, press any one of the tone group buttons.

#### NOTE

- You can adjust the balance between the main tone and layered tone. For details, see “Layered Tone Volume (Layer Balance)” (page E-44).

## Splitting the Keyboard between Two Tones

You can split the keyboard so the left side (lower range) plays one tone and the right side (upper range) plays a different tone.

*Example:* To split the keyboard between the GM SLAP BASS 1 tone on the left (lower range) and the GRAND PIANO CONCERT tone on the right (upper range).

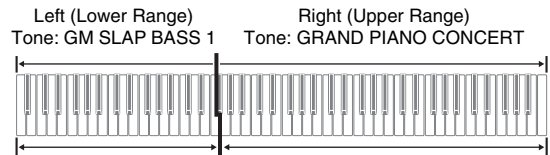

- Press the  $\text{36}$  (SPLIT) button.

This causes the SPLIT lamp to light, indicating that the keyboard is split between two tones.

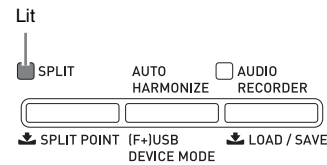

- Select the tone you want to assign to the left side (lower range) of the keyboard.

*Example:* To select GM SLAP BASS 1 in the GM TONES group, press the  $\text{27}$  (GM TONES) button and then use the  $\text{29}$  ( $\nabla$ ,  $\wedge$ ) buttons to select “037 GM SLAP BASS 1”.

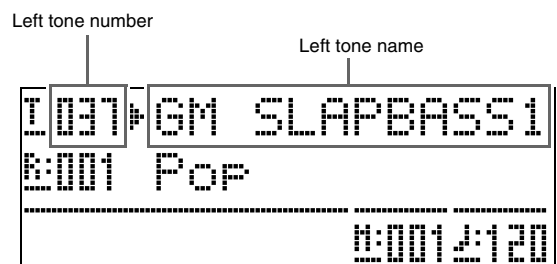

- To unsplit the keyboard and return it to a single tone, press the  $\text{36}$  (SPLIT) button.

The SPLIT lamp will go out, indicating that the keyboard is no longer split.

#### NOTE

- If the keyboard is set up with layered tones (page E-9) when you perform the above split operation, the layered tones will play on the right (upper range) side of the keyboard.

## Moving the Keyboard Split Point

You can use the procedure below to specify the location on the keyboard where it splits between the left side and the right side. That location is called the “split point”.

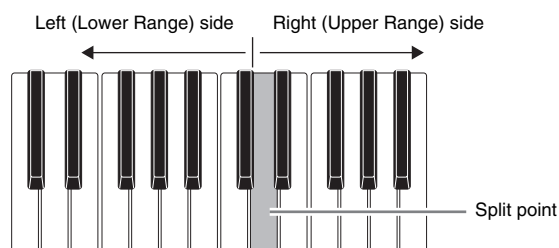

1. Hold down the **36 (SPLIT)** button until the split point setting screen appears on the display as shown below.

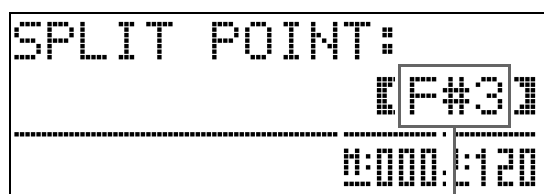

Current split point key name

2. Press the keyboard key where you want to specify as the leftmost key of the right (upper range) tone.  
This specifies the split point.
3. Press the **36 (SPLIT)** button.  
This exits the split point screen.

## Using Octave Shift

After you split the keyboard (page E-10), you may find out that the lower range notes on the left are too low or that the upper range notes on the right are too high. You can use octave shift to shift the octaves of the upper range and lower range upwards or downwards in octave units.

1. While holding down the **28 (FUNCTION)** button, press the **22 (GRAND PIANO)** button. This displays the octave shift screen.

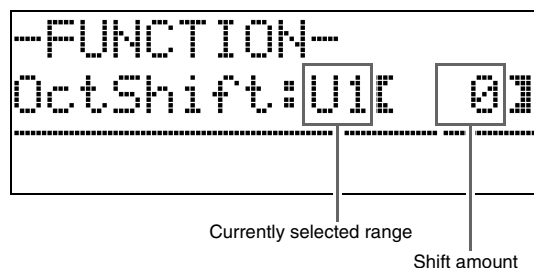

2. Use the **19 (PART)** button to select the range whose octave you want to change.
  - Each press of **19 (PART)** cycles through the ranges below.

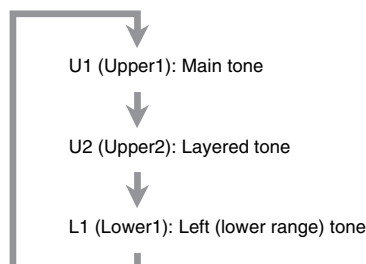

3. Use the **29 (∨, ∧)** buttons to shift the octave of the currently selected range.
  - You can shift the octave within the range of -2 to 0 to 2.
4. Press the **28 (FUNCTION)** button.  
This exits the octave shift screen.

### NOTE

- Octave shift also can be performed as described for “Octave Shift” (page E-44).

## Adjusting the Brilliance of a Tone

1. Press the **28 (FUNCTION)** button.

The FUNCTION lamp will light and the function screen will appear on the display.

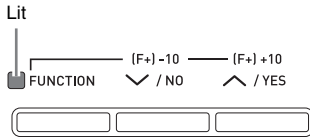

2. Use the **34 (>)** and **33 (<)** buttons to select the Tmpr/Effect screen.

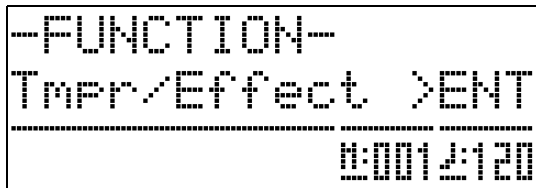

3. Press the **35 (ENTER)** button.

This will display a screen for selecting settings in the Tmpr/Effect group.

4. Use the **34 (>)** or **33 (<)** button to select the brilliance screen shown below.



5. Use the **29 (∇, ▲)** buttons to adjust the brilliance of the currently selected tone. You can adjust brilliance in the range of -3 to 0 to 3.

∇: Mellow and softer  
▲: Brighter and harder

6. Press the **28 (FUNCTION)** button.

This will exit the brilliance screen and cause the FUNCTION lamp to go out.

### NOTE

- See "Other Settings" (page E-43) for details about using the **28 (FUNCTION)** button.

## Adding Reverb to the Tone

1. While holding down the **28 (FUNCTION)** button, press the **30 (REVERB)** button.

This will display a reverb type selection screen.

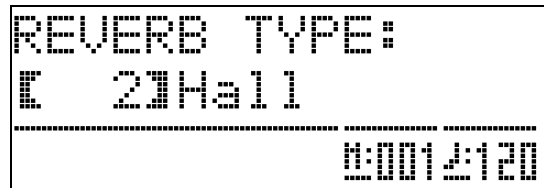

2. Use the **29 (∇, ▲)** buttons to select the reverb type you want.

- The following shows the five available reverb type settings.

0: OFF (no reverb)  
1: Room  
2: Hall  
3: Large Hall  
4: Stadium

3. Press the **28 (FUNCTION)** button.

This exits the reverb type selection screen.

## Adding the Chorus Effect to the Tone

1. While holding down the **28** (FUNCTION) button, press the **31** (CHORUS) button. This will display a chorus type selection screen.

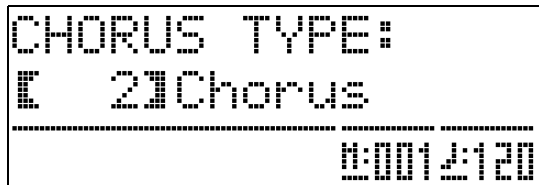

2. Use the **29** (V, ^) buttons to select the chorus type you want.
  - The following shows the five available chorus type settings.
    - 0: OFF (no chorus)
    - 1: Light Chorus
    - 2: Chorus
    - 3: Deep Chorus
    - 4: Flanger
3. Press the **28** (FUNCTION) button. This exits the chorus type selection screen.

## Using the Metronome

1. Press the **3** (METRONOME) button. This will start the metronome.

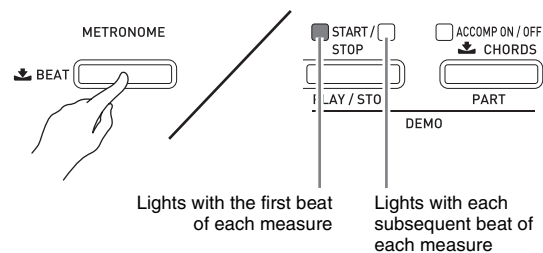

2. Press the **3** (METRONOME) button again to stop the metronome.

## Changing the Beats Per Measure

You can specify from two to six beats per measure for the metronome. After you do, a chime will sound at the beginning of each measure. Specifying 0 for this setting will sound a straight beat, without a chime. This setting lets you practice with a steady beat.

1. Hold down the **3** (METRONOME) button until the number of beats per measure screen shown below appears on the display.

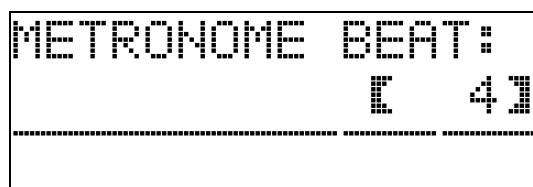

2. Use the **29** (V, ^) buttons to select the beats per measure value you want.
3. Press the **3** (METRONOME) button to exit the number of beats per measure screen.

## Changing the Tempo Setting

There are two different methods you can use to change the tempo setting: by pressing **20** (**^**) (faster) and **20** (**∨**) (slower) buttons or by tapping a beat with a button.

### ■ To adjust the tempo using **20** (TEMPO, ∨, ^) buttons

1. Use the **20** (TEMPO, ∨, ^) buttons to adjust the tempo setting.

Each press of a button increases or decreases the beats per minute value by one.

- Holding down either button changes the value at high speed.
- You can specify a tempo value in the range of 20 to 255.



### ■ To adjust the tempo by tapping a beat

1. Tap the **20** (TEMPO, TAP) button four times in time with the beat you want to specify.
  - The tempo setting will change in accordance with the timing of your tapping.

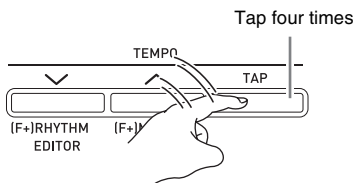

- After you use this method to specify the approximate tempo, you can then use the procedure under “To adjust the tempo using **20** (TEMPO, ∨, ^) buttons” to adjust the setting to a more exact value.

## Adjusting the Metronome Volume

You can use the following procedure to adjust the volume level of the metronome, without affecting the volume of Digital Piano output.

1. While holding down the **28** (FUNCTION) button, press the **3** (METRONOME) button. This displays the metronome volume screen.

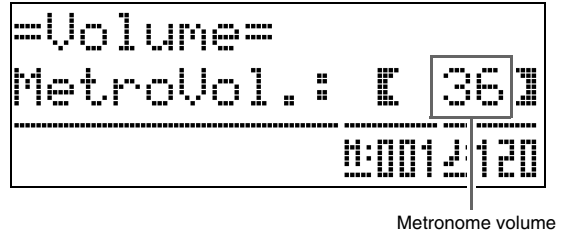

2. Use the **29** (∨, ^) buttons to adjust the metronome volume.
3. Press the **28** (FUNCTION) button. This will exit the metronome volume screen and cause the FUNCTION lamp to go out.

### NOTE

- You also can use the procedure under “Metronome Volume” (page E-44) to adjust the metronome volume.

## Using the Pitch Bend Wheel

You can use the pitch bend wheel to slide the pitch of notes smoothly upwards and downwards. This capability makes it possible to reproduce saxophone and electric guitar choking effects.

### Adding a Pitch Bend Effect

1. While playing a note on the keyboard, rotate the pitch bend wheel on the left of the keyboard upwards or downwards.

The amount the note bends depends on how much you rotate the pitch bend wheel.

- Do not have the pitch bend wheel rotated as you turn on the Digital Piano.



### NOTE

- You also can configure pitch bend wheel operation by specifying the amount of pitch change at maximum rotation in either direction. See “Pitch Bend Range” (page E-46) for more information.



## Playing a Duet

You can use the Duet Mode to split the Digital Piano's keyboard in the center so two people can play a duet. This makes it possible to configure the keyboard so, for example, the teacher can play on the left and the student can follow along on the right. Or one person can play the left hand part on the left, while another plays the right hand part on the right.

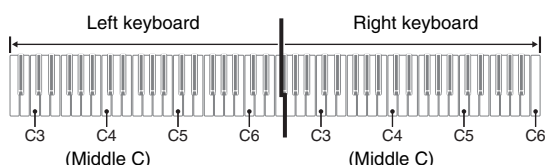

### Pedal Operation when Playing a Duet

#### ● Optional SP-33 Pedal Unit

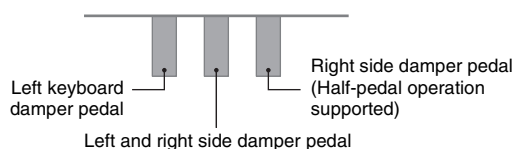

#### ● Supplied SP-3 Pedal Unit

To use the SP-3 Pedal Unit as the right keyboard damper pedal, connect it to the **42 (DAMPER PEDAL)** terminal.

- Half-pedal operation is not supported in this case.

To use the SP-3 Pedal Unit as the left keyboard (initial default setting) or right keyboard damper pedal (selectable), connect it to the **42 (SOFT/SOSTENUTO PEDAL)** terminal.

- For information about how to select left or right keyboard control with the SP-3 Pedal Unit, see "Soft/Sostenuto Pedal Jack Setting" (page E-46).

## Configuring the Digital Piano for Duet Play

1. Press the **13 (USER SONGS)** button so its lower lamp is lit.

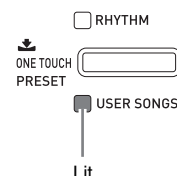

2. While holding down the **28 (FUNCTION)** button, press the **36 (SPLIT)** button.

This causes the Duet Mode on/off screen to appear.

- The keyboard keys are disabled while this screen is displayed.



3. Press the **29 (^)** button to turn on the Duet Mode.

This will cause the **36 (SPLIT)** button lamp to flash.

4. Press the **28 (FUNCTION)** button.

This exits the Duet mode on/off screen and configures the Digital Piano's keyboard for duet play.

5. To turn off the Duet Mode, press the **36 (SPLIT)** button so the SPLIT lamp goes out.

#### NOTE

- You also can use the procedure under "Duet Mode" (page E-44) to turn the Duet Mode on or off.

## Changing the Octave of a Duet Mode Keyboard

You can use the following procedure to change the octave of the left and right Duet Mode keyboards.

1. While holding down the **23 (FUNCTION)** button, press the **36 (SPLIT)** button.

This displays the Duet Mode on/off screen shown in step 2 under “Configuring the Digital Piano for Duet Play” (page E-15). If the Duet Mode is currently turned off, press the **23 (^)** button to turn it on.

2. Of the four C keys in the left keyboard, press the one that you want to have located at middle C.

- This will sound the note assigned to C4 and change the octave of the left keyboard.

*Example:* To change the configuration so the leftmost C key is middle C as shown below.

Leftmost C key (Pressed key)

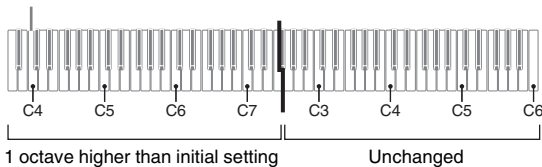

3. You can use the same procedure as step 2 to select one of the C keys in the right keyboard to shift its octave as well.

4. Press the **23 (FUNCTION)** button.

This exits the Duet Mode on/off screen and causes the **23 (FUNCTION)** button lamp to go out.

The left and right keyboards will be configured according to your settings.

### NOTE

- Turning off the Duet Mode will clear your octave shift settings and return the keyboard to its initial default settings.

# Using Auto Accompaniment

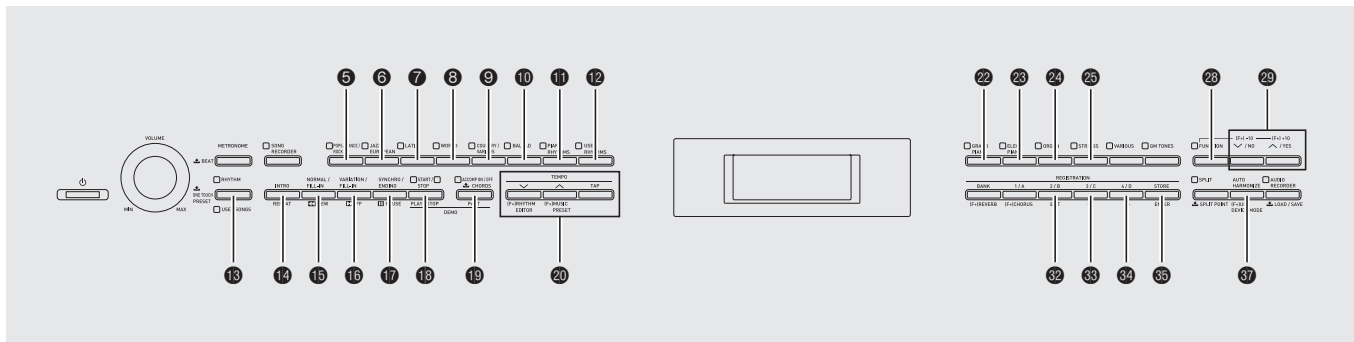

With Auto Accompaniment, simply select the accompaniment rhythm you want and the matching accompaniment (drums, guitar, etc.) will play automatically when you play a chord with your left hand. It's like having your own personal backup group along with you wherever you go.

This Digital Piano has 180 built-in Auto Accompaniment patterns, which are divided into seven groups. You can edit built-in rhythms to create your own original rhythms (called "user rhythms"), which you can save in a eighth group. For more information, see the "Rhythm List" (page A-5).

## Playing an Auto Accompaniment

**1.** Press the **13 (RHYTHM)** button so its upper lamp is lit.

This enables Auto Accompaniment.

- Each press of the button toggles between the RHYTHM and USER SONGS lamps.

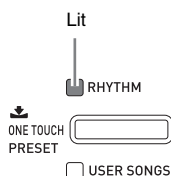

**2.** Use the "Rhythm List" (page A-5) to look up the group and the number of the rhythm you want to select.

**3.** Use the **5 to 12 (rhythm groups)** buttons to select the group you want.

*Example:* When the LATIN group is selected



**4.** Use the **29 (∨, ∧)** buttons to select the rhythm you want.

*Example:* When "005 Samba 2" is selected

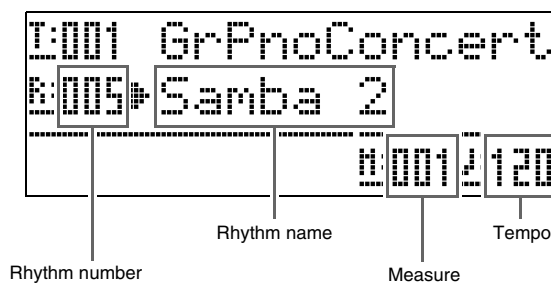

**5.** Use the **20 (TEMPO, ∨, ∧)** buttons to adjust the tempo setting.

- This is the same as metronome tempo adjustment (page E-13).
- To return the rhythm to its standard tempo setting, press the **20 (TEMPO, ∨, ∧)** buttons at the same time.

## 6. Press the **19 (ACCOMP ON/OFF)** button so its lamp is lit.

This turns ACCOMP on, so all accompaniment parts sound.

- Turning ACCOMP off so the ACCOMP lamp is unlit causes only the percussion instrument parts to sound.
- Each press of the **19 (ACCOMP ON/OFF)** button toggles ACCOMP on and off.

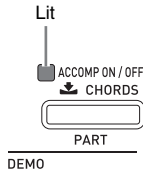

## 7. Press the **17 (SYNCHRO/ENDING)** button.

This puts Auto Accompaniment into “synchro standby”. Playing a chord during synchro standby will cause Auto Accompaniment to start to play automatically.

- Pressing the **14 (INTRO)** button while Auto Accompaniment is in synchro standby will enter intro standby. Pressing the **16 (VARIATION)** button will enter variation standby. For details about intro and variation patterns, see “Modifying Auto Accompaniment Patterns” (page E-20).

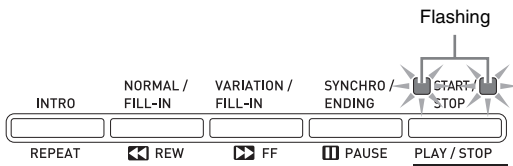

## 8. Play the chord you want on the chord keyboard (left keyboard keys).

Auto Accompaniment will start playing when you play the chord.

- To start percussion part play without playing a chord, press the **18 (START/STOP)** button.

*Example:* To play a C chord

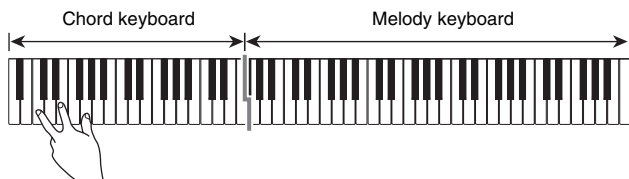

## 9. Play other chords with left hand as you play the melody with your right hand.

- You can use “CASIO Chord” or other simplified chord fingering modes to play chords. For details, see “Selecting a Chord Fingering Mode” in the following section.
- You can use the **15 (NORMAL)** and **16 (VARIATION)** buttons to modify accompaniment patterns. For details, see “Modifying Auto Accompaniment Patterns” (page E-20).

## 10. When you are finished, press the **18 (START/STOP)** button again to stop Auto Accompaniment.

- Pressing the **17 (SYNCHRO/ENDING)** button instead of the **18 (START/STOP)** button will play an ending pattern before stopping Auto Accompaniment play. For details about ending patterns, see “Modifying Auto Accompaniment Patterns” (page E-20).

### NOTE

- You can use the following procedure to adjust the volume level of the Auto Accompaniment, without affecting the volume of Digital Piano output. For details, see “Auto Accompaniment Volume” (page E-44).
- You can change the size of the chord keyboard by using the split feature to move the split point (page E-11). The keyboard keys to the left of the split point make up the chord keyboard.

## Selecting a Chord Fingering Mode

You can select from among the following five chord fingering modes.

- 1: Fingered 1
- 2: Fingered 2
- 3: Fingered 3
- 4: CASIO Chord
- 5: Full Range

1. Hold down the **19 (ACCOMP ON/OFF)** button until the chord type selection screen appears on the display.

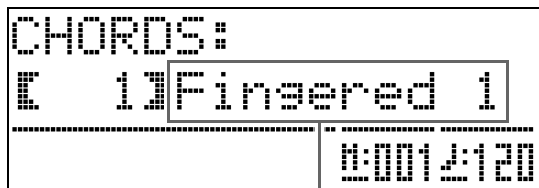

Chord fingering mode

2. Use the **29 (V, ^)** buttons to select the chord fingering mode you want.
3. Press the **19 (ACCOMP ON/OFF)** button. This exits the chord fingering screen.

### ■ Fingered 1, 2, 3

With these three chord fingering modes, you play chords on the chord keyboard using their normal chord fingerings. Some chord forms are abbreviated, and can be fingered with one or two keys. For information about the types of chords you can finger and their fingerings, see the “Fingering Guide” (page A-9).



- Fingered 1: Play the component notes of the chord on the keyboard.
- Fingered 2: Unlike Fingered 1, 6th input is not possible with this mode.
- Fingered 3: Unlike Fingered 1, this mode allows input of fraction chords with the lowest keyboard note as the bass note.

## ■ CASIO CHORD

With “CASIO Chord”, you can use simplified fingerings to play the four types of chords described below.



Chord Type	Example
<b>Major Chords</b> Press one key, whose note corresponds to the chord name. • To play C Major, press any C key in the chord keyboard. The octave of the note does not matter.	<b>C (C Major)</b> Note name
<b>Minor Chords</b> Press the chord keyboard key that corresponds to the major chord, while also pressing one other chord keyboard key to the right.	<b>Cm (C minor)</b> 
<b>Seventh Chords</b> Press the chord keyboard key that corresponds to the major chord, while also pressing two other chord keyboard keys to the right.	<b>C7 (C seventh)</b> 
<b>Minor Seventh Chords</b> Press the chord keyboard key that corresponds to the major chord, while also pressing three other chord keyboard keys to the right.	<b>Cm7 (C minor seventh)</b> 

When pressing more than one chord keyboard key, makes no difference whether the additional keys are white or black.

## ■ FULL RANGE CHORD

With this chord fingering mode, you can use the full range of the keyboard to play chords and the melody. For information about the types of chords you can finger and their fingerings, see the “Fingering Guide” (page A-9).

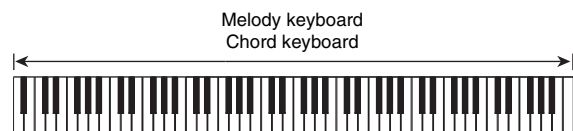

## Modifying Auto Accompaniment Patterns

There are six different Auto Accompaniment patterns, shown below. You can switch between patterns during accompaniment play and even modify patterns. Use buttons 14 through 17 to select the pattern you want.

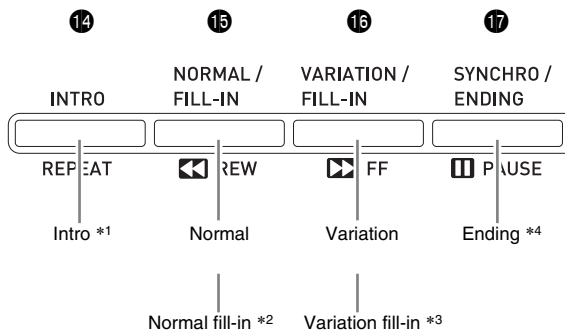

- \*1 Press at the beginning of a song. Accompaniment play proceeds with the normal pattern after the intro pattern is complete. Pressing the 16 (VARIATION/FILL-IN) button before pressing this button will proceed with the variation pattern after the intro pattern is complete.
- \*2 Press while a normal pattern is playing to insert a fill-in pattern.
- \*3 Press while a variation pattern is playing to insert a fill-in variation pattern.
- \*4 Press at the end of a song. This will play an ending pattern and then stop Auto Accompaniment.

## Using One-Touch Presets

One-Touch Preset gives you one-touch access to tone and tempo settings that go well with the currently selected Auto Accompaniment rhythm pattern.

1. Hold down the 13 (RHYTHM) button for at least two seconds.

This will configure tone, tempo, and other settings to match the currently selected rhythm pattern. At this time, Auto Accompaniment play also will go into synchro standby, which means that Auto Accompaniment will start to play automatically when you finger a chord.

2. Play a chord on the keyboard.

This will start Auto Accompaniment play.

### NOTE

- One-Touch Presets are not supported for user rhythms (001 through 010 of the USER RHYTHMS group).

## Using Auto Harmonize

Auto Harmonize lets you add harmony to melody notes you play with your right hand. You can select any one of 12 Auto Harmonize settings.

1. Press the 37 (AUTO HARMONIZE) button.

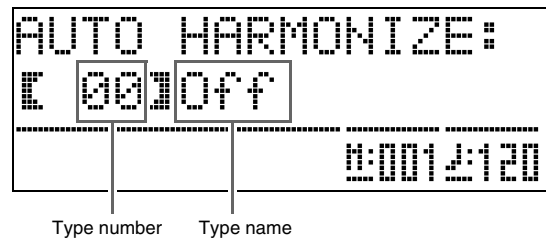

2. Use the **29** (**∨**, **∧**) buttons to select the Auto Harmonize type you want.

Type Number	Type Name	Description
00	Off	Turns off Auto Harmonize.
01	Duet 1	Adds close (separated by two to four degrees) one-note harmony below the melody note.
02	Duet 2	Adds open (separated by more than 4 to 6 degrees) 1-note harmony below the melody note.
03	Country	Adds country style harmony.
04	Octave	Adds the note from the next lower octave.
05	5th	Adds the fifth degree note.
06	3-Way Open	Adds 2-note open harmony, for a total of three notes.
07	3-Way Close	Adds 2-note close harmony, for a total of three notes.
08	Strings	Adds harmony that is optimal for strings.
09	4-Way Open	Adds 3-note open harmony, for a total of four notes.
10	4-Way Close	Adds 3-note close harmony, for a total of four notes.
11	Block	Adds block chord notes.
12	Big Band	Adds big band style harmony.

3. Press the **37** (**AUTO HARMONIZE**) button.  
This will exit the auto harmonize screen.
4. While playing chords, play the melody on the keyboard.  
Harmony will be added to your melody notes based on the chords you play.

## Creating Your Own Original Rhythms

You can use rhythm editing to modify a built-in Auto Accompaniment rhythm to create an original “user rhythm” of your own. You can select a part (drum, bass, etc.) of a normal, intro, or other pattern (page E-20) and turn it on or off, adjust its volume level, and perform other operations.

1. Select the number of the Auto Accompaniment rhythm you want to edit.
2. At the same time, press the **23** (**FUNCTION**) and **20** (**RHYTHM EDITOR**) buttons.  
This displays the rhythm editor screen.

```

-RHYTHM EDITOR-
Part: [DRUM]
Rhythm Select:
[001] Pop
  
```

3. Use the accompaniment pattern buttons (**14** through **17**) to select the pattern (normal, intro, ending, etc.) you want to edit.

The button you press will light, indicating that the pattern is being edited.

- Each press of **15** (**NORMAL/FILL-IN**) toggles between NORMAL and FILL-IN, and each press of **16** (**VARIATION/FILL-IN**) toggles between VARIATION and FILL-IN. The applicable button flashes while the fill-in pattern is selected.

Example: When intro is selected

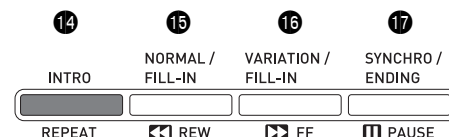

**4.** Use the instrument part buttons (5 through 12) to select the part (drums, bass etc.) you want to edit.

The name of the part you select will appear on the display. Rhythm patterns are made up of the eight parts shown below.

- Button illumination does not change when you press the instrument part buttons (5 through 12). Button illumination indicates whether there is accompaniment data corresponding to each part.

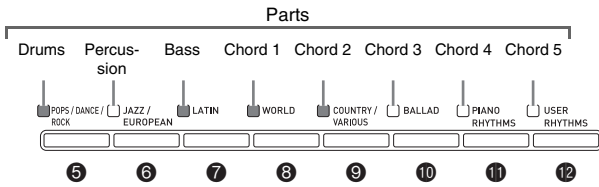

Example: When bass is selected

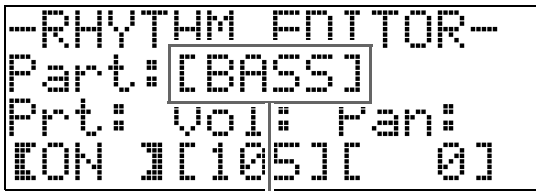

Instrument part name

**5.** Edit the selected part as desired.

The table below describes the parameters you can edit.

- Use the 33 (<) and 34 (>) buttons to select a parameter, and the 29 (v, ^) buttons to change its setting. You also can use shortcut buttons (see table below) to select parameters.
- Pressing the 29 (v, ^) buttons at the same time will return the currently selected parameter to its initial default setting.
- Pressing the 13 (START/STOP) button during an edit operation will sound the accompaniment pattern with the edits you have made up to that point. Pressing the 15 (ACCOMP ON/OFF) button will sound only the instrument part you are editing.

Procedure continues on page E-23.

Parameter	Description	Setting	Shortcut Button
Rhythm Select: Rhythm	Replaces the part (drum, bass, etc.) accompaniment data with that of the specified rhythm number. *1	001 to 190: Rhythm number *2 *3	22
Tone Select: Tone	Switches the part tone (instrument) to that of the specified tone number.	001 to 250: Tone Numbers *2 *4	23
Prt: Part on/off	Toggles each part on or off.	OFF: Mutes the part. ON: Sounds the part.	24
Vol: Volume level	Controls the volume level of each part.	000 to 127	
Pan: Panning (position)	Controls whether the sound of the part can be heard from the left side or right side.	-64 to 0 to 63 *5	
Reverb: Reverb	Controls the level of the reverb effect (page E-12) applied to the part notes.	000 to 127	25
Chorus: Chorus	Controls the level of the chorus effect (page E-13) applied to the part notes.	000 to 127	

\*1 Replacing part accompaniment data clears all edits to the currently selected accompaniment data made up to that point.  
 \*2 Sequential numbers starting from 001, which is the first rhythm of the first group (POPS/DANCE/ROCK). See the "Tone List" (page A-1) and "Rhythm List" (page A-5) for information on the numbering system.  
 \*3 In the case of the intro and ending, specifying a rhythm for one part (drum, bass, etc.) will cause the same rhythm to be specified automatically for all of the other parts of the pattern.  
 \*4 Only drum set sounds (tone numbers 237 through 250) can be selected for drum parts and percussion parts. Drum set sounds cannot be selected for the bass and the chord 1 through chord 5 parts.  
 \*5 A smaller value shifts leftward, while a larger value shifts rightward. A value of zero specifies center.



6. Repeat steps 3 through 5 to edit all of the accompaniment patterns and parts you want.
7. After editing is complete, adjust the tempo of the rhythm as desired.
  - The tempo you set here becomes the initial default tempo of the rhythm.
8. Press the **32** (EXIT) button.

This causes a confirmation message to appear asking if you want to save your edits.

```

--RHYTHM EDITOR--
SAVE?

No/Yes
  
```

9. Press the **29** (YES) button.

This displays a screen for specifying the user rhythm number and rhythm name.

- If you want to exit the editing operation without saving, press the **28** (NO) button instead of the **29** (YES) button.

```

--RHYTHM EDITOR--
Area & Name
[001]PianoRockBld
>ENT
  
```

Destination user rhythm number

Rhythm name

10. Decide on the user rhythm number where you want to save the rhythm and a rhythm name.
  - Use the **33** (<) and **34** (>) buttons to move the cursor to the user rhythm number and rhythm name character you want to change. Use the **29** (∨, ^) buttons to select the number or character you want.
  - The rhythm name characters you can select are shown below. To input a space, press both of the **29** (∨ and ^) buttons at the same time.

!	"	#	\$	%	&	'	(	)	
*	+	,	-	.	/	0	1	2	3
4	5	6	7	8	9	:	;	<	=
>	?	@	A	B	C	D	E	F	G
H	I	J	K	L	M	N	O	P	Q
R	S	T	U	V	W	X	Y	Z	[
¥	]	^	_	`	a	b	c	d	e
f	g	h	i	j	k	l	m	n	o
p	q	r	s	t	u	v	w	x	y
z	{		}						

11. Press the **35** (ENTER) button.

This saves the data.

- If the rhythm number where you are saving the data already has data saved to it, a message (Replace?) will appear on the display to confirm whether you want to replace the existing data with the new data.



#### IMPORTANT!

- Saving user rhythm data to a user rhythm number that already has data will cause the existing data to be replaced by the new data.



#### NOTE

- If the size of the accompaniment pattern or instrument part data is too large to be edited, a memory full message (Memory Full) will appear on the display. If that happens, select a different accompaniment pattern or instrument part for editing.

# Playing Demo Songs

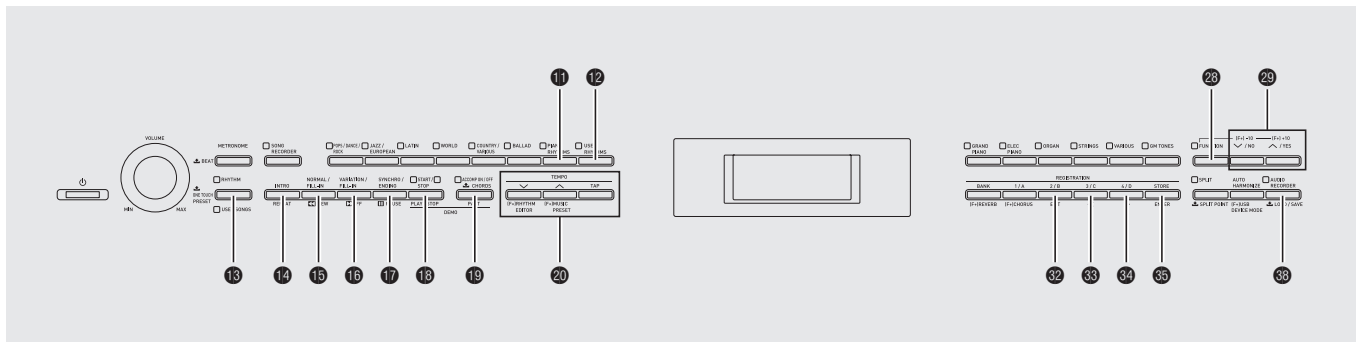

## Playing Tone Demo Songs

Your Digital Piano comes with six built-in demo tunes, which demonstrate the characteristics of each of the six tone groups.

No.	Tone Group Name	Tune Name
001	GRAND PIANO	Original
002	ELEC PIANO	Original
003	ORGAN	Original
004	STRINGS	Nessun Dorma [Turandot]
005	VARIOUS	Original
006	GM TONES	Original

1. While holding down the **19 (PART)** button, press the **18 (PLAY/STOP)** button.  
This will start sequential playback of the demo songs, starting from song 1.

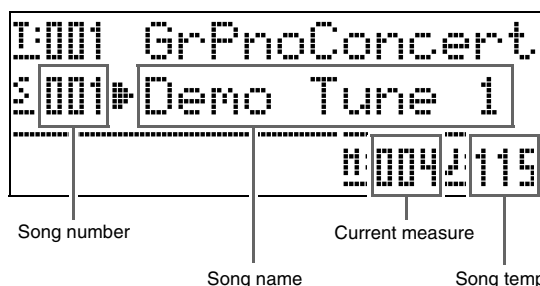
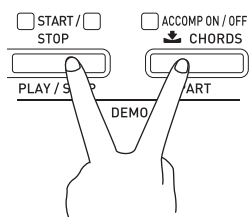

- Pressing a tone group button (**22** through **27**) while demo song playback is in progress will switch to the demo song of that group's tone. Also, you can scroll through songs manually with the **28 (V)**, **29 (^)** buttons.

2. Press the **18 (PLAY/STOP)** button.  
This stops demo song playback.  
Playback of the demo songs will continue in an endless loop until you press the **18 (PLAY/STOP)** button to stop it.

### NOTE

- Only the operations described above can be performed while demo song playback is in progress.

## Listening to Songs Loaded from an External Source

You can import song data from a commercially available USB flash drive or computer as a user song, and use it for Auto Accompaniment or for practice.

### 1. Load the song data you want to listen to one of the Digital Piano's user songs.

- See "Loading Data from a USB Flash Drive to Digital Piano Memory" (page E-50) and "Connecting to a Computer" (page E-54) for details about how to load data.
- You also can play back data directly from a USB flash drive without importing it into Digital Piano memory. For details, see "Playing Back a Song on a USB Flash Drive" (page E-52).

### 2. Press the **13 (USER SONGS)** button so its lamp is lit.

- Each press of the button toggles between the upper and lower lamps.

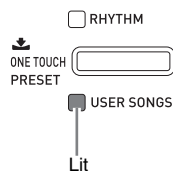

### 3. Use the **29 (V, ^)** buttons to select the user song you want.

*Example:* When user song 003 is selected

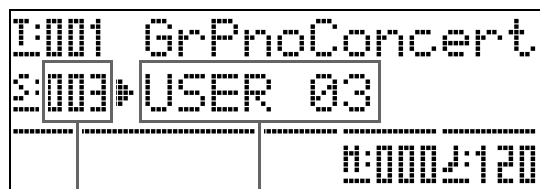

User song number      Song name

### 4. Press the **18 (PLAY/STOP)** button.

This starts playback of the song.

- Press the **16 (FF)** button to perform a fast forward operation or the **15 (REW)** button for rewind. Pressing and releasing either button moves one measure, while holding down a button scrolls at high speed.
- Pressing the **17 (PAUSE)** button pauses playback. Press again to resume song playback.

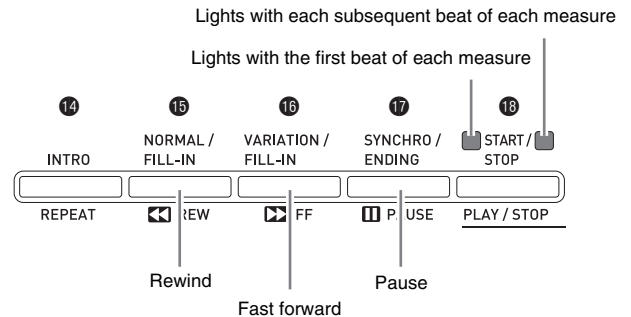

### 5. Press the **18 (PLAY/STOP)** button again.

This stops song playback.

- Song playback also will stop automatically when the end of the song is reached. To configure the Digital Piano to loop song playback without stopping, turn on "Song Repeat" (page E-45).

## Changing the Song Tempo

You can change the song tempo using the same procedure that you use to adjust the metronome tempo. For more information, see "Changing the Tempo Setting" (page E-14).

## Playing on the Keyboard Using the Same Tone as the Song

### 1. Hold down the **13 (USER SONGS)** button for at least two seconds.

This will assign the same tone as the right hand part of the current song to the keyboard.

#### NOTE

- You can use the procedure under "Practicing Either Hand's Part (Part Off)" (page E-26) to turn off the left hand part and play along on the keyboard using the left hand part tone.

## Adjusting the Song Volume

You can use the following procedure to adjust the volume level of the song's Auto Accompaniment, without affecting the volume of keyboard tone output. For details, see "Song Volume" (page E-44).

## Practicing Either Hand's Part (Part Off)

You can turn off the right hand part<sup>\*1</sup> or left hand part<sup>\*2</sup> of a song and play that part on the Digital Piano while the song plays back.

\*1 Song data Channel 4 (fixed)

\*2 Song data Channel 3 (fixed)

1. Press the **19 (PART)** button.  
This causes "L-[ON] R-[ON]" to appear on the display.
2. Use the **29 (∨, ∧)** buttons to turn off the part you want.  
Press (∨) to toggle the left hand part or (∧) to toggle the right hand part on and off.
3. Press the **19 (PART)** button again.  
This exits the part on/off screen.
4. Hold down the **13 (USER SONGS)** button for at least two seconds.
  - This will assign the same tone as the hand that is turned off to the keyboard.
5. Press the **18 (PLAY/STOP)** button to start song playback.  
The part you turned off does not sound, so you can play it on the keyboard.

## Sounding a Count at the Beginning of a Song

You can configure the Digital Piano to sound a count before playback of a song starts, which helps to get the timing right when you are playing along on the keyboard. For details, see "Pre-count" (page E-45).

## Repeating Playback of a Specific Section (Repeat)

You can configure the Digital Piano to repeat the section of a song you want to practice. You could, for example, specify repeat play from measure 5 to measure 8.

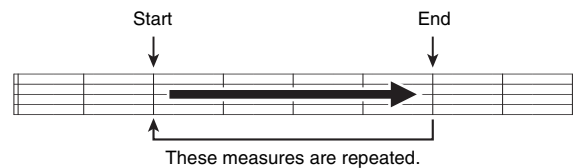

1. Press the **18 (PLAY/STOP)** button.  
This starts playback of the song.
2. When playback reaches the first measure of the section you want to repeat, press the **14 (REPEAT)** button.  
This makes the measure the "start measure". The **14 (REPEAT)** button lamp flashes at this time.
3. When playback reaches the last measure of the section you want to repeat, press the **14 (REPEAT)** button again.  
This makes the measure the "end measure". Repeat playback of the specified section starts as soon as you select the end measure. The **14 (REPEAT)** button lamp is lit (not flashing) at this time.
4. Pressing **14 (REPEAT)** again returns to normal play.  
This will cause the **14 (REPEAT)** button lamp to go out.

## Playing Back Audio Data Stored on a USB Flash Drive

You can use your Digital Piano to play back audio data (WAV files\*) stored on a commercially available USB flash drive.

See “USB Flash Drive” on page E-47 for more information.

\* Linear PCM, 16bit, 44.1 kHz, Stereo

### PREPARATION

- Prepare a USB flash drive that contains data recorded to it using the Digital Piano’s Audio Recorder. See “Recording to a USB Flash Drive (Audio Recorder)” on page E-41 for more information.
- You can also use a computer to save audio data (WAV file) to the USB Flash Drive for playback. See “Storing Standard Audio Data (WAV Files) to a USB Flash Drive” on page E-48 for more information.
- Insert the USB flash drive that contains the data you want to play back into your Digital Piano’s USB flash drive port.

### 1. Press the **38** (AUDIO RECORDER) button.

- This will cause the button’s lamp to light.

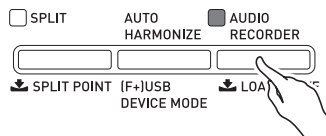

### 2. While holding down the **28** (FUNCTION) button, press the **38** (AUDIO RECORDER) button.

- This will display the audio file selection screen.

### 3. Use the **29** (∨, ∧) buttons to select a song.

- The **29** (∧) button scrolls forward through the song file names (WAV01, WAV02, etc.) The **29** (∨) button scrolls backward through the song file names.

### 4. Press the **32** (EXIT) button.

### 5. Press the **18** (PLAY/STOP) button.

- This will start playback of the selected song.

### 6. To stop a song, press the **18** (PLAY/STOP) button again.

- To exit the Audio Recorder, press the **38** (AUDIO RECORDER) button. This will cause the lamp above the AUDIO RECORDER button to go out.

# Music Presets

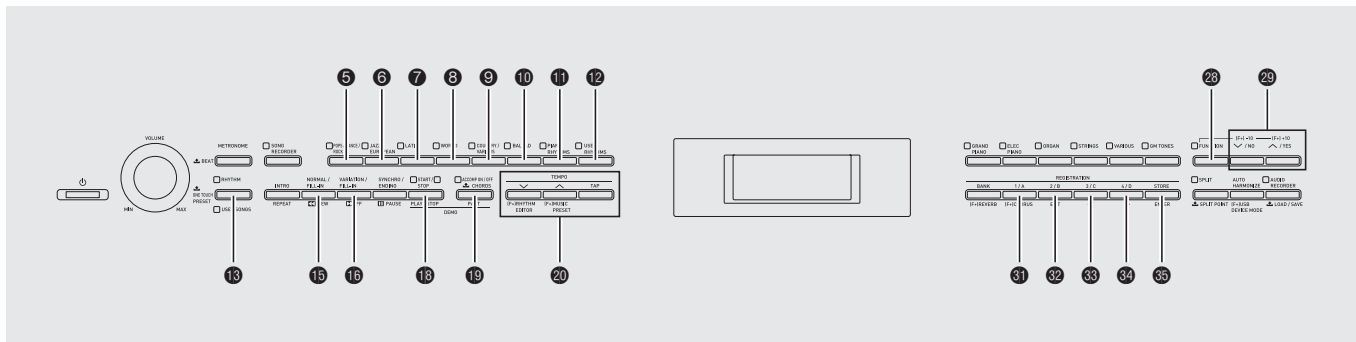

Music Presets provide you with one-touch tone, rhythm, chord, and other settings that are optimized for specific musical genres and songs. In addition to built-in presets, you can create your own original Music Presets (user presets).

There are a total of 300 built-in Music Presets, which are divided into three groups (1, 2, 3). A fourth group (4) is provided for user presets.

- For more information, see the “Music Preset List” (page A-7).

## Selecting a Music Preset

1. While holding down the **26 (FUNCTION)** button, press the **20 (MUSIC PRESET)** button.

This causes the **19 (ACCOMP ON/OFF)** lamp to flash and the Music Preset screen to appear.

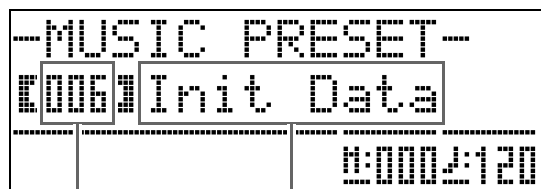

Music Preset number

Music Preset name

2. Use buttons **31** to **34** (Music Preset group buttons) to select a group, and then use the **29 (∨, ∧)** buttons to select the Music Preset you want.

This will configure the Digital Piano with settings (tone, rhythm, etc.) of the selected Music Preset.

The following are the settings that are included in a Music Preset.

- Tones (main, layer, lower split) (page E-9)
- Layer balance (page E-9)
- Octave shift (page E-11)
- Reverb (page E-12)
- Chorus (page E-13)
- Rhythm (page E-21)
- Tempo (page E-20)
- Auto Harmonize (page E-20)

3. Press the **18 (START/STOP)** button to start Auto Accompaniment with the chord progression of the Music Preset. Play the melody on the keyboard.

- The preset chord progression repeats until you stop it by pressing the **18 (START/STOP)** button again.
- Pressing the **19 (ACCOMP ON/OFF)** button so the ACCOMP ON/OFF lamp is lit (not flashing) or unlit will turn off the chord progression of the Music Preset and play the normal Auto Accompaniment pattern.

Each press of the **19 (ACCOMP ON/OFF)** button cycles in the sequence shown below.

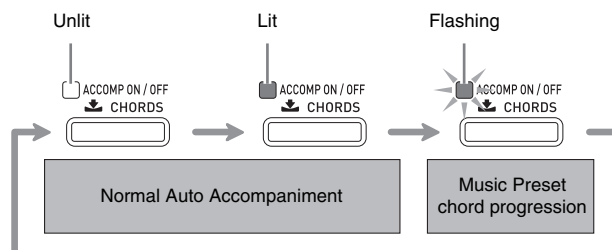

- To change the rhythm, use the 5 through 12 (rhythm group) buttons to select the rhythm group and then use the 29 (V, ^) buttons to select a rhythm number.
- To change the tone, use the 22 through 27 (tone group) buttons to select the tone group and then use the 29 (V, ^) buttons to select a tone number.

4. To exit a Music Preset, while holding down the 28 (FUNCTION) button, press 20 (MUSIC PRESET) button.

## Creating an Original User Preset

A Music Preset editor is provided to allow you to create your own original Music Presets (user presets). Up to 50 user presets can be stored in Music Preset Group 4.

1. Select the Music Preset you want to edit in order to create your user preset.
2. Change the tone number, rhythm number, and other settings of the Music Preset as you want.
  - The settings you configure here will be saved as a user Music Preset. See step 2 under "Selecting a Music Preset" (page E-28) for the settings you can configure and save for a user Music Preset.
3. Press the 28 (FUNCTION) and 20 (RHYTHM EDITOR) buttons at the same time.

This displays a screen for selecting the type of editing operation you want to perform.

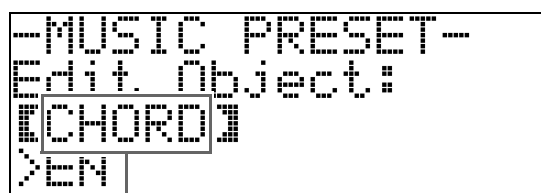

Editing operation type

4. Edit the Music Preset parameters.

### 4-1. To edit the chord progression

Press the 29 (V) button to display "CHORD" and then press the 35 (ENTER) button to advance to the chord progression editing screen.

Next, perform the editing operation described under "To edit the chord progression" (page E-30). After you finish the editing operation, press the 32 (EXIT) button to return to the screen for selecting the type of editing operation, above.

### 4-2. To edit Auto Accompaniment parameters

Press the 29 (^) button to display "Parameter" and then press the 35 (ENTER) button to advance to the Auto Accompaniment parameter editing screen.

Next, perform the editing operation described under "To edit Auto Accompaniment parameters" (page E-32). After you finish the editing operation, press the 32 (EXIT) button to return to the screen for selecting the type of editing operation, above.

5. After editing everything you want, press the 32 (EXIT) button.

- This will display a message asking if you want to save the user preset.

6. Press the 29 (YES) button.

This displays a screen for selecting the Music Preset number and name for storing the edited data.

- If you do not want to save the edited data, press the 29 (NO) button in place of the 29 (YES) button.

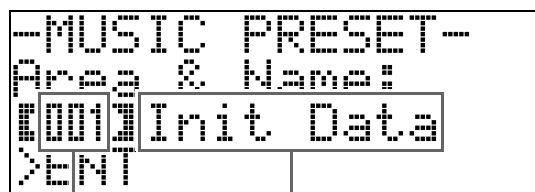

Music Preset name

Music Preset number for data storage

7. Use the **29** (**∨**, **∧**) buttons to select the Music Preset number where you want to store the edited data.

8. Enter a name for the preset.

Use the **33** (**<**) and **34** (**>**) buttons to move the cursor to the character you want to change and then use the **29** (**∨**, **∧**) buttons to change the character. The following shows a table of available characters.

- To input a space, press both of the **29** (**∨** and **∧**) buttons at the same time.

!	"	#	\$	%	&	'	(	)	
*	+	,	-	.	/	0	1	2	3
4	5	6	7	8	9	:	;	<	=
>	?	@	A	B	C	D	E	F	G
H	I	J	K	L	M	N	O	P	Q
R	S	T	U	V	W	X	Y	Z	[
¥	]	^	_	`	a	b	c	d	e
f	g	h	i	j	k	l	m	n	o
p	q	r	s	t	u	v	w	x	y
z	{		}						

9. Press the **35** (**ENTER**) button.

This saves the data.

- If the preset number where you are saving the data already has data saved to it, a message (Replace?) will appear on the display to confirm whether you want to replace the existing data with the new data. Press the **29** (**YES**) button to overwrite or the **29** (**NO**) button to cancel the save operation.

### To edit the chord progression

1. On the editing operation selection screen (page E-29), select "CHORD" and then press the **35** (**ENTER**) button to display the chord progression editing screen shown below.

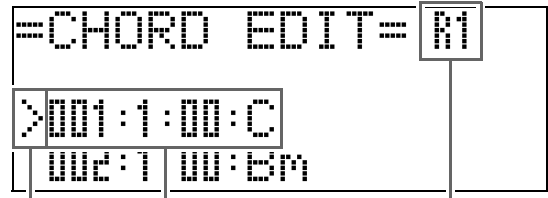

(2) Cursor (1) Step (timing and chord) (3) Resolution

#### (1) Step (timing and chord)

The timing of a chord progression is expressed as a series of three values separated by colons (such as 001:1:00) indicating measure <sup>\*1</sup> (001), beat (1), and tick (00)<sup>\*2</sup>. This series of three values is referred to collectively as a "step".

The screen shot above shows the first two steps (001, 002) of the Music Preset. Use the **15** (**REW**) and **16** (**FF**) buttons to scroll and view other steps.

\*1 Up to 999 measures

\*2 There are 12 ticks per beat, as shown below.

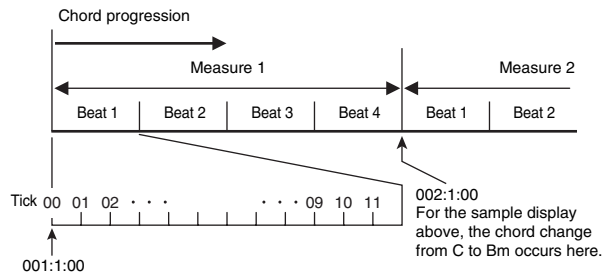

#### (2) Cursor

Specifies the step that is currently selected for editing.

#### (3) Resolution

Resolution is a unit used when editing step timing. The initial resolution is R1 (one measure), but you also can select R4 (1 beat = 1 quarter note) when you want to specify chords for each beat. Use the instrument part buttons (**5** through **12**) to select one of the eight resolutions shown below.

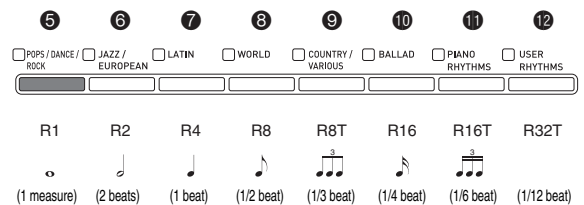



2. Use the **15 (REW)** and **16 (FF)** buttons to move the cursor (2) on the chord progression editing screen to the step you want to select.

3. Change the content of the selected step as desired.

**3-1. Select a chord fingering mode and use the chord keyboard (page E-19) to input chords.**

Fingering a chord causes the cursor (2) to move to the next step automatically.

- If you want to advance to the next step without changing the current chord, press the **17 (PAUSE)** button.
- If (3) Resolution is shorter than the time up to the next step, a new step (without chord) that is equal to the time of the resolution will be inserted temporarily into the Music Preset. Fingering a chord for the new step will cause the step to be registered as part of the Music Preset, and the cursor will advance to the next step.\* You can use this operation to insert a new step between the current and following step.

\* Using the **15 (REW)** and **16 (FF)** buttons to move the cursor without inputting a chord will delete the temporarily inserted step.

**3-2. Use the **29 (∇, ^)** buttons to change the step timing (measure:beat:tick).**

Each press of either button changing the timing in accordance with the resolution.

- The range of values you can specify for the step timing is limited by the steps before and after the current step.
- The timing of the first step (001:1:00) is fixed and cannot be changed. Also, the final step is always one measure, regardless of the resolution.

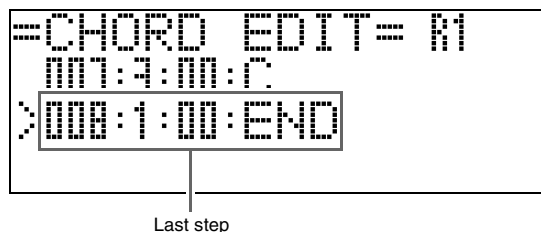

**3-3. To delete a step, press both of the **29 (∇)** and **30 (^)** buttons at the same time.**

- You cannot delete the first step or the last step.

4. Repeat the above steps to edit all of the steps you want.

- You can playback the Music Preset you are currently editing by pressing the **16 (START/STOP)** button.
- The table below describes other Music Preset editing operations you can perform. Press the **28 (FUNCTION)** button, use the **33 (<)** and **34 (>)** buttons to select the editing operation you want, perform the required operation, and then press the **35 (ENTER)** button to apply the edit and return to the chord progression editing screen.
- To exit the editing operation and discard all of your edits, press the **32 (EXIT)** button.

	Editing Operation (Display)	Description	Operation
1	Initialize (Initialize)	Initializes all steps. Initialization is useful when you want to create a totally new chord progression from scratch.	-
2	Change Key (Change Key)	Changes the pitch (key) of the chords in all of the steps in semitone units.	Use the <b>29 (∇, ^)</b> buttons to select the amount of change you want (-5 to 6 semitones).
3	Append Music Preset (Append Chords)	Copies all of the steps of another Music Preset to the end of the current Music Preset.	Use the <b>29 (∇, ^)</b> buttons to select the number* of the Music Preset you want to add.
4	Delete Measures (DELETE Measure)	Deletes a specified number of measures from the current cursor step forward.	Use the <b>29 (∇, ^)</b> buttons to select the measures.
5	Insert Measure (INSERT 1Measure)	Inserts a blank measure at the currently selected step.	-

\* The Music Presets in groups 2, 3, and 4 are numbered sequentially, following the numbers in group 1, which start with 1. For details about sequential numbers, see the "Music Preset List" on page A-7.

5. After all editing operations are complete, press the **32 (EXIT)** button to return to the editing operation selection screen (page E-29).

**NOTE**

- A single preset can contain up to approximately 2,000 chords. If your edits cause the chord limit to be exceeded, the message "Memory Full" will appear on the display and further editing will become impossible.

■ To edit Auto Accompaniment parameters

1. On the editing operation selection screen (page E-29), select “Parameter” and then press the **35** (ENTER) button to display the Auto Accompaniment parameter editing screen shown below.

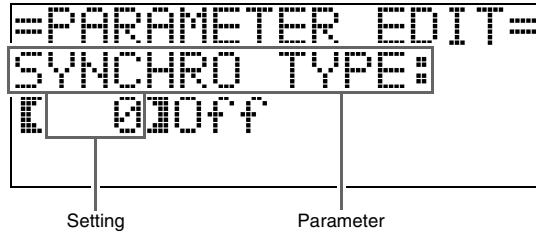

2. Use the **33** (<) and **34** (>) buttons to select a parameter, and the **29** (v, ^) buttons to change its setting.

	Parameter	Description	Setting
1	SYNCHRO TYPE: Synchro type	Selects the synchro standby status and type when the Music Preset is selected.	0 Off: Off (no standby) 1 Normal: From standby to normal pattern 2 Variation: From standby to variation pattern 3 Intro: From standby to intro pattern
2	DRUM ON/OFF: Drum on/off	Toggles the drum part (page E-22) on or off.	OFF: Mutes the part. ON: Sounds the part.
3	PERC ON/OFF: Percussion on/off	Toggles the percussion part (page E-22) on or off.	OFF: Mutes the part. ON: Sounds the part.
4	BASS ON/OFF: Bass on/off	Toggles the bass part (page E-22) on or off.	OFF: Mutes the part. ON: Sounds the part.
5 - 9	CHORD1 - 5 ON/OFF: Chord 1 - 5 on/off	Toggles the Chord 1 through 5 parts (page E-22) on or off.	OFF: Mutes the parts. ON: Sounds the parts.
10	INTRO CHORD: Intro chord	Selects from among major (× 12 keys) and minor (× 12 keys) for the intro chords.	C - B: Major (C to B) Cm - Bm: Minor (Cm to Bm)
11	ENDING CHORD: Ending chord	Selects from among major (× 12 keys) and minor (× 12 keys) for the ending chords.	C - B: Major (C to B) Cm - Bm: Minor (Cm to Bm)
12	AUTO FILL-IN: Auto fill in on/off	Specifies whether or not a fill-in should be inserted into the final measure of a chord progression.	OFF: Fill-in not inserted ON: Fill in inserted
13	TIMING SET: Chord progression variation	This parameter lets you add different variations to the timing of the chord progression being edited. You can use it to match the chord progression to the beat of a specific rhythm. • A chord (step) that is outside of the rhythm's beat is cut off.	1 Normal: Edited chord progression proceeds as-is. 2 Half: Halves chord timing within a measure. 3 Double: Doubles chord timing within a measure. 4 3/4: Multiplies chord timing within a measure by 3/4. Select this setting to match to a 6/8 time rhythm. 5 6/4: Multiplies chord timing within a measure by 3/2. Select this setting to match to a 6/4 time rhythm.

3. After all editing operations are complete, press the **32** (EXIT) button to return to the editing operation selection screen (page E-29).

# Registering Tone and Rhythm Setups

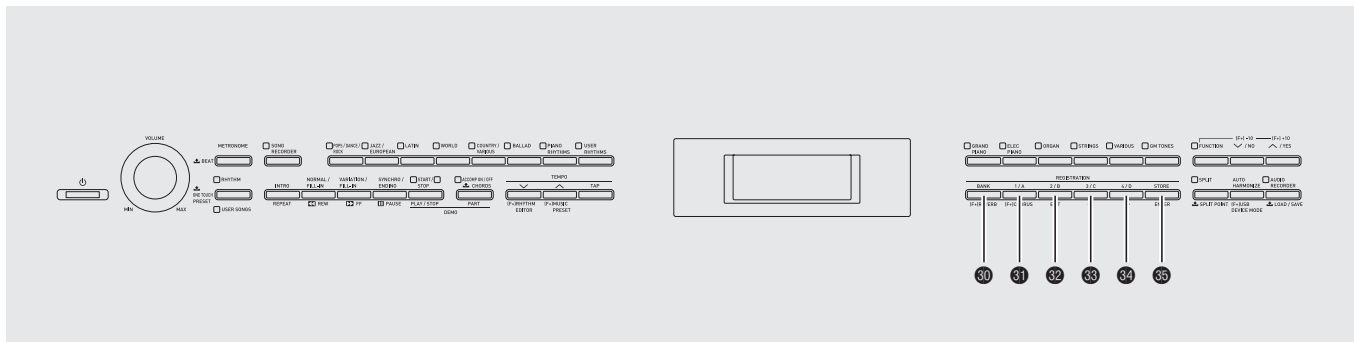

Registration memory lets you store Digital Piano setups (tone, rhythm, etc.) for instant recall whenever you need them. Registration memory simplifies performance of complex pieces that require successive tone and rhythm changes.

You can have up to 96 setups in Registration memory at one time. The **30 (BANK)** button and **31 (REGISTRATION 1)** to **34 (REGISTRATION 4)** buttons are used for recording.

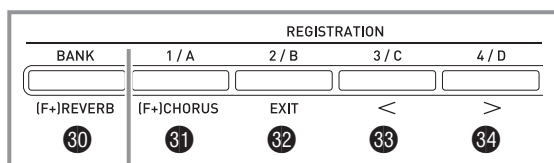

	Area 1	Area 2	Area 3	Area 4
Bank 1	Setup 1-1	Setup 1-2	Setup 1-3	Setup 1-4
Bank 2	Setup 2-1	Setup 2-2	Setup 2-3	Setup 2-4
.	.	.	.	.
Bank 24	Setup 24-1	Setup 24-2	Setup 24-3	Setup 24-4

- Each press of the **30 (BANK)** button cycles through the bank numbers, from 1 to 24.
- Pressing a button from the **31** to **34** buttons selects the corresponding area in the currently selected bank.

Setup 8-2 data

**Tone Settings**

Keyboard Tone: 014 Harpsichord  
 Brightness: 2  
 Reverb: 1 Room  
 Chorus: Off

**Auto Accompaniment Settings**

Rhythm: 005 Pop Rock  
 Tempo: 180  
 Accompaniment Volume: 20

## ■ Registration Data Types

### ● Tone Settings

- Tone numbers (main, layer, split)
- Layer on/off
- Layer balance
- Split on/off
- Split point
- Octave shift
- Brightness
- Reverb
- Chorus
- Transpose
- Touch response
- Soft/sostenuto pedal setting
- Damper pedal adjustment
- Pitch bend range

### ● Auto Accompaniment Settings (Areas 1 through 4 only)

- Rhythm number
- Accomp on/off
- Chord fingering mode
- Synchro standby
- Tempo
- Auto Accompaniment volume
- Auto harmonize

## Saving Registration Data

1. Configure the Digital Piano with the tone, rhythm, and other settings you want to save.
2. Press the **30 (BANK)** button to select the bank where you want to save the registration.

Example: Bank 4



3. Next, hold down the **35 (STORE)** button as you use the **31** through **34** buttons to select an area.

The data will be saved to the bank and area you specify.

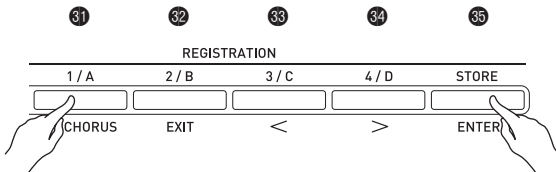

Example: Bank 4, Area 1



## Recalling a Registration

1. Press the **30 (BANK)** button to select the bank that contains the setup you want to recall.

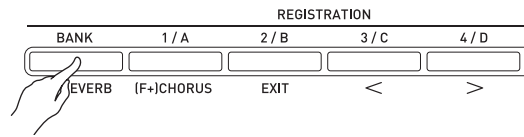

2. Use the buttons **31** to **34** to select the area whose setup you want to recall.

This will recall the registration memory setup and automatically configure the Digital Piano settings accordingly.

Example: When recalling the registration data in Bank 4, Area 1



### ■ Saving registration Data on an External Device

See "Connecting to a Computer" (page E-54) for details about how to transfer sampled data to a computer for storage.

# Recording Your Keyboard Play

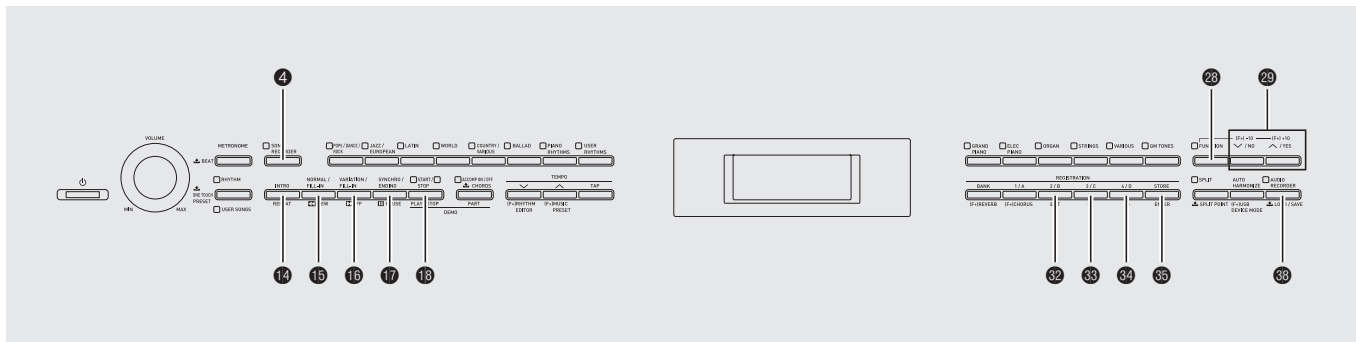

You can use the Song Recorder to record what you play on the Digital Piano to built-in song memory. You can divide a song into parts (by instrument, by left hand and right hand, etc.) and record each part separately. You can even use “punch-in recording” to edit specific parts of existing recordings. When a commercially available USB flash drive is inserted in the Digital Piano’s USB flash drive port, audio data is recorded to and played back from the USB flash drive (Audio Recorder).

## Recording to Built-in Song Memory (Song Recorder)

The following are the steps for recording or playing back a single recorder memory song.

1. Press the **4 (SONG RECORDER)** button twice so its lamp is flashing.

This turns on the Song Recorder and enters the record mode.

- Each press of the **4 (SONG RECORDER)** button cycles through modes as shown below.

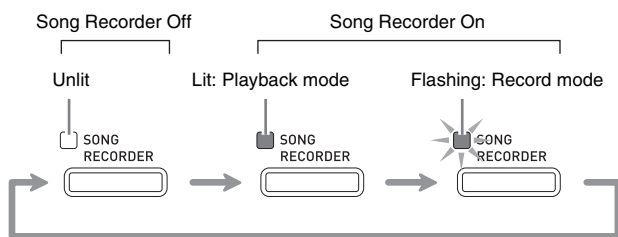

2. Configure the tone, rhythm, and other settings you want to use.

- The settings you configure here will be included as part of the recorded song data.
- For details about what is included in the recorded song data, see “System Track” (page E-37).

3. Play something on the keyboard.

Recording starts as soon as you play something.

- If Auto Accompaniment is playing, it will be included in the recorded data.

4. When you are finished, press the **18 (START/STOP)** button.

This will cause the **4 (SONG RECORDER)** lamp to flash and then light, indicating the playback mode.

- If you are using Auto Accompaniment, you also can end the recording session by pressing the **17 (ENDING)** button.

Lit: Playback mode

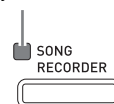

5. To play back what you have recorded, press **18 (START/STOP)** again.

- Each press of **18** starts and stops playback.

6. To exit the Song Recorder, press the **4** (SONG RECORDER) button again so its lamp goes out.

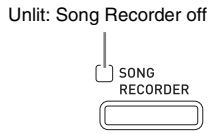

### NOTE

- Recorder memory capacity is approximately 10,000 notes per song. When remaining capacity is 100 notes or less, the **4** (SONG RECORDER) button lamp will flash at high speed. Recording will stop automatically when memory becomes full.
- Repeat, fast reverse, fast forward, pause, and tempo adjustment during playback are the same as when playing back user songs. See “Listening to Songs Loaded from an External Source” (page E-25) for more information.
- You can listen to the song data currently stored in recorder memory at any time by pressing the **4** (SONG RECORDER) button to enter the playback mode and then pressing **18** (START/STOP).

### IMPORTANT!

- A new recording replaces (deletes) previously recorded contents.
- If power to the Digital Piano is cut off while recording is in progress, everything you recorded up to that point will be deleted. Take care so power is not turned off accidentally during recording operations.

## Recording or Playing Back Multiple Songs

You can record up to five songs (numbered 1 through 5) in memory. After that, you can select a specific song for playback.

1. Use the **4** (SONG RECORDER) button to cycle through the Song Recorder modes until the lamp above the **SONG RECORDER** button is lit. This is the Song Recorder playback mode.

Lit: Playback mode

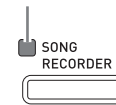

2. While holding down the **28** (FUNCTION) button, press the **4** (SONG RECORDER) button.

This displays the song selection screen.



3. Use the **29** (V, ^) buttons to select the song number you want.
4. Press the **32** (EXIT) button to exit the song selection screen.
5. To record to the currently selected song, press the **4** (SONG RECORDER) button. To play back the currently selected song, press the **18** (START/STOP) button.
6. If you are recording, continue from step 2 under “Recording to Built-in Song Memory (Song Recorder)” (page E-35).

## Recording to a Specific Track (Part)

You can record specific instruments, the left hand and right hand, or other parts of a song individually, and then combine them into a final song.

### ■ What is a track?

A “track” is a separate recorded part of a song. The Song Recorder of this Digital Piano has a total of 17 tracks, one of which is a system track as described below.

#### ● System Track

In addition to notes you play on the keyboard and other performance operation data, the system track also includes a wide range of setup information for the song, including layer on/off, split on/off, tempo, Auto Accompaniment settings, reverb on/off, etc. When you record a single-track song to recorder memory, as shown under “Recording to Built-in Song Memory (Song Recorder)” (page E-35) and “Recording or Playing Back Multiple Songs” (page E-36), everything is recorded to the system track.

#### ● Tracks 01 through 16

These tracks can be used to record notes, as well as pitch bend wheel and pedal operations, and the keyboard tone setting. These tracks can be combined with the system track and each other to create the final song.

### ■ Supported Track Data

The following describes the data that can be recorded to each type of track.

#### System Track, Tracks 01 through 16

Keyboard notes, keyboard tone setting (main), pedal and pitch bend wheel operation

#### System Track only

Layer, split, octave shift, reverb, chorus, tempo, Auto Accompaniment play, auto harmonize, one-touch preset, Music Preset<sup>\*1</sup>, registration<sup>\*1\*2</sup>

\*1 Recall only

\*2 The Auto Accompaniment volume level and transpose setting of the recalled data is not included in the recording.

### 1. Record the first part to the system track.

- Use the procedure under “Recording to Built-in Song Memory (Song Recorder)” (page E-35) or “Recording or Playing Back Multiple Songs” (page E-36) to record to the system track.

### 2. Use the **4** (SONG RECORDER) button to cycle through the Song Recorder modes until the lamp above the **SONG RECORDER** button is flashing. This is the Song Recorder record mode.

Flashing: Record mode



### 3. While holding down the **28** (FUNCTION) button, press the **4** (SONG RECORDER) button.

This displays the track selection screen.

Use the **29** (V, ^) button to select the track you want to record next (T01 through T16).

After selecting a track, press the **32** (EXIT) button to exit the track selection screen.

Track Name	Display
System Track	Sys
Tracks 01 through 16	T01 through T16

```

--RecSetting--
TrSelect:  [Sys]
-----
          0:0012:120
  
```

4. Select the tone of the part you want to record to the track.
5. Press the **18 (START/STOP)** button.  
This will start playback of what you recorded to the system track and start recording to the currently selected track. Play what you want to record to the current track along with the playback from the system track.
6. To stop recording, press the **18 (START/STOP)** button again.  
This enters the playback mode. Press the **18 (START/STOP)** button again to play back the track you just recorded. Each press of **18 (START/STOP)** starts and stops playback.
  - You can use the following procedure to turn specific tracks on (play enabled) and off (play disabled). This allows you to listen only to the track(s) you want when recording a new track.
    - (1) While holding down the **28 (FUNCTION)** button, press the **4 (SONG RECORDER)** button.  
This displays the song selection screen.
    - (2) Press the **34 (>)** button once.  
This displays the track on/off screen.
    - (3) Use the **29 (∨, ^)** buttons to select the track you want, and then press the **35 (ENTER)** button to toggle it on or off.
7. Repeat steps 2 through 6 as required to record all of the tracks you want.

## Deleting Data Recorded with the Song Recorder

Performance data recorded with the Song Recorder can be deleted song-by-song. You also can delete a particular track from a song.

### Deleting a Recorder Song

1. Use the **4 (SONG RECORDER)** button to cycle through the Song Recorder modes until the lamp above the **SONG RECORDER** button is lit. This is the Song Recorder playback mode.

Lit: Playback mode

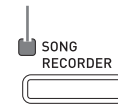

2. While holding down the **28 (FUNCTION)** button, press the **4 (SONG RECORDER)** button.  
This displays the recorder song selection screen.
3. Use the **29 (∨, ^)** buttons to select the recorder song you want to delete.
4. Hold down the **4 (SONG RECORDER)** button until the message "Sure?" appears on the display.
5. Press the **29 (YES)** button to delete the recorder song.
  - To cancel the delete operation, press the **29 (NO)** button.



## Deleting a Particular Track

1. Perform steps 1 through 3 of the procedure under “Deleting a Recorder Song” to select the recorder song that contains the track you want to delete.
2. Press the **34 (>)** button.  
This displays the track selection screen.
3. Use the **29 (∨, ^)** buttons to select the track you want to delete.
4. Hold down the **4 (SONG RECORDER)** button until the message “Sure?” appears on the display.
5. Press the **29 (YES)** button to delete the track.
  - To cancel the delete operation, press the **29 (NO)** button.

## Re-recording Part of a Recorder Song (Punch-in Recording)

You can use punch-in recording to re-record a specific part of recorder song that you want to improve or correct.

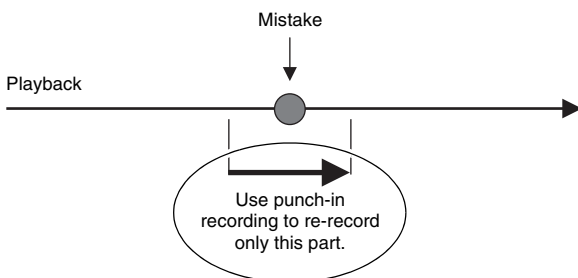

1. Enter the Song Recorder record mode and select the track that contains the section you want to re-record.
  - See step 3 under “Recording to a Specific Track (Part)” (page E-37).
2. Hold down the **4 (SONG RECORDER)** button until the punch-in recording screen appears on the display.

```

--PunchIn Rec--
AutoIN/OUT: [OFF]
-----
0:001 2:120
  
```

3. Press the **18 (START/STOP)** button.  
This will start playback of the selected track.
4. When playback reaches the point you want to re-record, play the notes and perform the other operations you want.  
This automatically starts punch-in recording, which will continue until step 5, below.
  - Any one of the following also will start punch-in recording: a pedal or pitch bend wheel operation; pressing the **4 (SONG RECORDER)** button;<sup>\*1</sup> changing the tone setting; changing the rhythm, or tempo setting<sup>\*2</sup>
  - \*1 Press **4 (SONG RECORDER)** when you want to start punch-in recording without note input or a setting change.
  - \*2 System track only
  - You can perform **15 (REW)**, **16 (FF)**, and **17 (PAUSE)** button operations during punch-in playback to jump more quickly to the section you want to re-record.
5. To stop punch-in recording, press the **18 (START/STOP)** button again.

Anything in the track following the point where you pressed the **18 (START/STOP)** button will be retained as-is.

- If you want to delete all of the data in the track following the section you re-recorded with punch-in recording, press the **4 (SONG RECORDER)** button in place of the **18 (START/STOP)** button above.
- If you want to cancel punch-in recording and retain the original (unedited) track data, hold down the **4 (SONG RECORDER)** button until the display exits the punch-in recording screen.

## Specifying the Punch-in Recording Location (Auto Punch-in Recording)

You can use the following procedure to specify a particular range for punch-in recording.

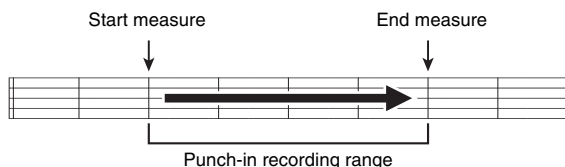

1. Enter the Song Recorder record mode.
  - While holding down the **28** (FUNCTION) button, press the **4** (SONG RECORDER) button. This will display the recording setup screen.
2. Use the **33** (<) and **34** (>) buttons to display “AutoPu.IN”, and then use the **29** (∨, ^) buttons to select the start measure.
3. Use the **33** (<) and **34** (>) buttons to display “AutoPu.OUT”, and then use the **29** (∨, ^) buttons to select the end measure.
  - After selecting the start and end measures, press the **32** (EXIT) button to exit the recording setup screen.
4. Select the track that contains the range of measures you want to re-record.
  - See step 3 under “Re-recording Part of a Recorder Song (Punch-in Recording)” (page E-39).
5. Press the **29** (^) button to turn on auto punch-in recording.
6. Press the **18** (START/STOP) button to start playback.
  - Punch in recording will start from the start measure and stop with the end measure automatically.
  - Play the notes and perform the other operations you want.

## ■ Performing Punch-in Recording for Areas Smaller than One Measure

Use the procedure below to specify a punch-in recording area that includes a part of a measure.

*Example:* To re-record from beat 3 of measure 2 up to beat 1 of measure 4

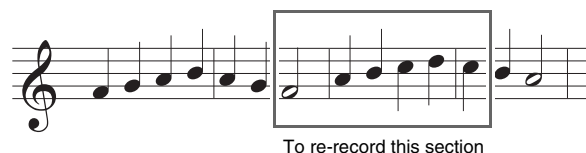

1. Start playback of the song that contains the section you want to re-record.
2. When playback reaches the beginning of the section you want to re-record, press the **14** (REPEAT) button.
3. When playback reaches the end of the section you want to re-record, press the **14** (REPEAT) button again.
4. Press the **18** (START/STOP) button to stop playback.
5. Enter the Song Recorder record mode and select the track that contains the section you want to re-record.
  - For information about selecting a track, see step 3 under “Recording to a Specific Track (Part)” (page E-37).
6. Hold down the **4** (SONG RECORDER) button until the punch-in recording screen appears on the display.
7. Press the **29** (^) button to turn on auto punch-in recording.
8. Press the **14** (REPEAT) button to turn on repeat.
9. Press the **18** (START/STOP) button.
 

This starts punch-in playback from the measure before the location (start point) you specified in step 2, above.

  - Punch-in recording starts automatically when playback reaches the start point and ends automatically when it reaches the location you specified in step 3 (end point).

## Recording to a USB Flash Drive (Audio Recorder)

Anything played on the Digital Piano is recorded to the USB flash drive as audio data (WAV files\*). If you play along on the Digital Piano as you play back data stored in song memory, the memory playback and your keyboard play are both recorded to USB flash drive.

\* Linear PCM, 16bit, 44.1 kHz, Stereo

### Recording Capacity

- 99 files (No. 01 to No. 99)
- Approximately 25 minutes maximum recording per file

### Recorded Data

- Anything played on the Digital Piano is recorded.
- Individual part recording is not supported.

### Recording Data Storage

Each new recording of audio data to a USB flash drive is automatically assigned a new file name, so existing data is not overwritten.

## Recording Digital Piano Play (Audio Recorder)

### PREPARATION

- Be sure to format the USB flash drive on the Digital Piano before using it. See “USB Flash Drive” on page E-47 for more information.

### 1. Insert the USB flash drive into the Digital Piano’s USB flash drive port.

- When you perform a USB flash drive operation or turn on the Digital Piano while a USB flash drive is plugged in, the Digital Piano initially needs to perform a “mounting” sequence to prepare for data exchange with the USB flash drive. Digital Piano operations are momentarily disabled while a mounting sequence is being performed. While the mounting process is in progress, the message “Media Mounting” will be displayed or “\*\*\*\*\*” will flash on the display. It may take up to 10 or 20 seconds or even longer for a USB flash drive to be mounted. Do not attempt to perform any operation on the Digital Piano while a mounting sequence is in progress. A USB flash drive needs to be mounted each time it is connected to the Digital Piano.

### 2. Press the **Ⓜ** (AUDIO RECORDER) button as many times as necessary until its lamp starts to flash (which indicates audio recording standby).

- The first press of the **Ⓜ** (AUDIO RECORDER) button may cause the message “Media Mounting” to appear on the Digital Piano display. If this happens, wait until the display returns to normal. After that, press the **Ⓜ** (AUDIO RECORDER) button again until its lamp starts to flash.

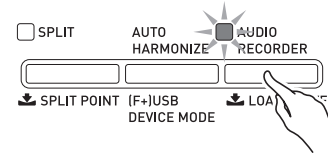

### 3. Start playing something on the keyboard.

- This will start recording to the USB flash drive. The message “A.Rec Start” will appear on the display a few seconds after recording starts.

### NOTE

- Do not remove the USB flash drive from the USB flash drive port while the **AUDIO RECORDER** button lamp is lit or flashing. Doing so will interrupt recording and may corrupt data.

### 4. To stop recording, press the **Ⓜ** (AUDIO RECORDER) button.

- The **AUDIO RECORDER** button lamp will flash for a short while after you press it, and then it will stop flashing and remain lit to let you know that audio recording is complete. Do not perform the operations below while the **AUDIO RECORDER** button lamp is flashing.
- At this time, you can press the **Ⓜ** (PLAY/STOP) button to replay what you have just recorded. To stop playback, press the **Ⓜ** (PLAY/STOP) button.
- To continue with audio recording, press the **Ⓜ** (AUDIO RECORDER) button so its lamp flashes. To exit audio recording, press the **Ⓜ** (AUDIO RECORDER) button twice so its lamp goes out.

## Recording Digital Piano Play as Data Recorded in Song Memory Plays Back (Audio Recorder)

### 1. Press the **Ⓜ** (SONG RECORDER) button.

- This causes the **SONG RECORDER** button lamp to light.

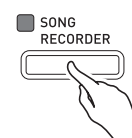

2. Press the **38 (AUDIO RECORDER)** button as many times as necessary until its lamp starts to flash (which indicates audio recording standby).

- The first press of the **38 (AUDIO RECORDER)** button may cause the message “Media Mounting” to appear on the Digital Piano display. If this happens, wait until the display returns to normal. After that, press the **38 (AUDIO RECORDER)** button again until its lamp starts to flash.

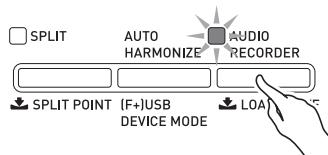

3. Press the **18 (PLAY/STOP)** button.

- This will start playback of the current song memory contents. Play along on the Digital Piano.

4. To stop recording, press the **38 (AUDIO RECORDER)** button.

- The **AUDIO RECORDER** button lamp will flash for a short while after you press it, and then it will stop flashing and remain lit to let you know that audio recording is complete. Do not perform the operations below while the button is flashing.
- To continue with audio recording, press the **38 (AUDIO RECORDER)** button so its lamp flashes. To exit audio recording, press the **38 (AUDIO RECORDER)** button twice so its lamp goes out.

## Playing Back Data Recorded on a USB Flash Drive

1. Press the **38 (AUDIO RECORDER)** button.

- The above step is not necessary if you want to play back recorded data immediately after recording it (because the **AUDIO RECORDER** button lamp is already lit).
- This causes the **AUDIO RECORDER** button lamp to light.

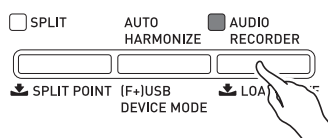

2. While holding down the **28 (FUNCTION)** button, press the **38 (AUDIO RECORDER)** button.

This will display the audio file selection screen.

3. Use the **29 (V, ^)** buttons to select a song.

- The **29 (V)** button scrolls through the recorded songs in order from the newest (most recently recorded) to the oldest.
- The **29 (^)** button scrolls from the old to the new.

4. Press the **32 (EXIT)** button.

5. Press the **18 (PLAY/STOP)** button.

6. To stop a song, press the **18 (PLAY/STOP)** button again.

- To exit the Audio Recorder, press the **38 (AUDIO RECORDER)** button. This will cause the lamp above the **AUDIO RECORDER** button to go out.

## Deleting an Audio File from a USB Flash Drive

Files can be deleted one at a time.

### IMPORTANT!

- The procedure below deletes all of the data of the selected track. Note that the delete operation cannot be undone. Check to make sure you really do not need the data in Digital Piano memory before you perform the following steps.

1. Press the **38 (AUDIO RECORDER)** button.

- This will cause the **AUDIO RECORDER** button lamp to light.

2. While holding down the **28 (FUNCTION)** button, press the **38 (AUDIO RECORDER)** button.

This will display the audio file selection screen.

3. Use the **29 (V, ^)** buttons to select the song you want to delete.

- The **29 (V)** button scrolls through the recorded songs in order from the newest (most recently recorded) to the oldest.
- The **29 (^)** button scrolls from the old to the new.

4. Hold down the **38 (AUDIO RECORDER)** button until the message “Sure?” appears on the display.

5. To delete the data, press the **29 (YES)** button.

This will delete the Audio Recorder data you selected.

- To cancel the delete operation, press the **29 (NO)** button.

### NOTE

- The file number of file you delete remains unused. Recording a new file will cause the file number that comes after the last file recorded to the USB flash drive.

# Other Settings

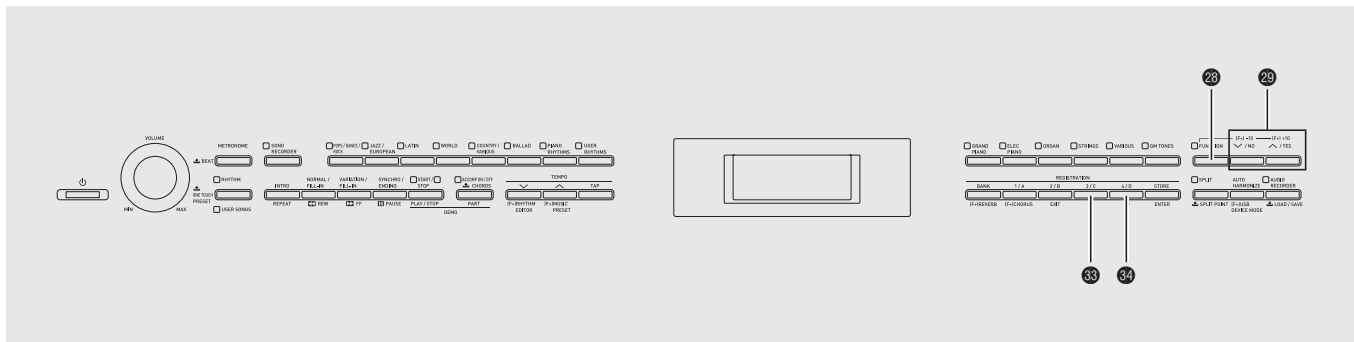

You can use the settings in this section to adjust the tuning and touch of the keyboard, to configure pedal and MIDI settings, and to configure other parameters in order to tailor Digital Piano operation to your particular needs.

## Configuring Settings

### 1. Press the 28 (FUNCTION) button.

The FUNCTION lamp will light and the function screen will appear on the display. (See table below.)

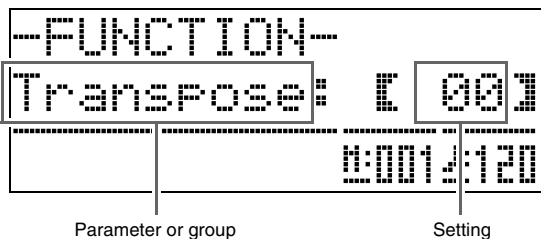

### 2. Use the 33 (<) and 34 (>) buttons to select one of the parameters (1 through 8) shown in the table below.

- Parameters 4 through 8 actually are parameter groups. After selecting a group, press the 35 (ENTER) button, and then use buttons 33 (<) and 34 (>) to select the parameter you want.
- Short cut buttons also are available for accessing a parameter directly after you press the 28 (FUNCTION) button, without going through the menu. See the "Shortcut Button" column in the table below for the applicable shortcut button of each parameter.

### 3. Use the 29 (∨, ∧) buttons to change the setting of the currently selected parameter.

- To return to the function screen, press the 32 (EXIT) or 28 (FUNCTION) button.

#### NOTE

- Holding down the 28 (FUNCTION) button while you press the 29 (∨, ∧) buttons in step 3 will scroll the setting in steps of 10.
- You also can use the 28 (FUNCTION) button for faster scrolling while changing the tone number, rhythm number, and other scrollable settings.
- Keep the 28 (FUNCTION) button depressed while pressing a 29 (∨, ∧) button for high-speed scrolling. Releasing the 28 (FUNCTION) button first can result in another unintended setting being changed.

No.	Parameter	Display Name	Description	Settings	Shortcut Button*
1	Keyboard Key (Transpose)	Transpose	Adjusts keyboard tuning by semitone units.	-12 to 00 to 12 semitones	22
2	Keyboard Fine Tuning (Tuning)	Tune	Raises or lowers the overall pitch of the Digital Piano in 0.1 Hz steps from the standard pitch of A4 = 440.0 Hz.	415.5 Hz to 440.0 Hz to 465.9 Hz	23
3	Keyboard Touch (Touch Response)	Touch	Adjusts keyboard touch.	Off: Off 1: Strong sound even with light pressure 2: Normal 3: Normal sound even with strong pressure	24
4	Volume Level Group	Volume			25
4-1	Layered Tone Volume (Layer Balance)	LayerBal.	Adjusts the volume level of the layered tone without changing the keyboard main tone.	-24 to 00 to 24	-
4-2	Auto Accompaniment Volume	AccompVol.	Adjusts the volume level of Auto Accompaniment without changing the keyboard tone volume level.	00 to 42	28 - 13*
4-3	Song Volume	SongVol.	Adjusts the volume level of user song playback without changing the keyboard tone volume level.	00 to 42	28 - 13*
4-4	Metronome Volume	MetroVol.	See page E-14.	00 to 42	28 - 13*
5	Temperament/Effect Group	Tmpr/Effect			26
5-1	Temperament	Temper.	Changes the temperament of the keyboard and Auto Accompaniment from the standard equal temperament to another tuning more suitable for playing classics, etc. Pressing a keyboard key while the temperament screen is displayed will make the pressed key the base note of the temperament.	<Temperaments> 00: Equal / 01: Pure Major / 02: Pure Minor / 03: Pythagorean / 04: Kimberger 3 / 05: Werckmeister / 06: Mean-Tone / 07: Rast / 08: Bayati / 09: Hijaz / 10: Saba / 11: Dashti / 12: Chahargah / 13: Segah / 14: Gurjari Todi / 15: Chandrakauns / 16: Charukeshi  <Base notes> C to B (12 types)	-
5-2	Accompaniment Temperament	AccompTmpr	Turn this setting off to play Auto Accompaniment patterns using standard equal temperament (00: Equal), regardless of the temperament setting currently selected with the Temperament parameter (5-1).	Off, On	-
5-3	Stretch Tuning	Stretch	Sharpens high notes and flattens low notes to achieve stretch tuning. Turn off this setting to play with normal (non-stretch) tuning.	Off, On	-
5-4	Brilliance	Brilliance	See page E-12.	-3 to 0 to 3	-
5-5	Octave Shift	OctShift	See page E-11.	U1 : -2 to 0 to 2 U2 : -2 to 0 to 2 L1 : -2 to 0 to 2	28 - 22*
5-6	Duet Mode	Duet	See page E-15.	Off, On	28 - 36*

\* 28 - 13 in this column means, "While holding down 28, press 13."

No.	Parameter	Display Name	Description	Settings	Shortcut Button*
6	Song Playback/ USB Flash Drive Group	Play/Media			38
6-1	Pre-count	PreCount	Turn on this setting for an audible count before starting playback of a user song or a song on a USB flash drive.	Off, On	-
6-2	Song Repeat	SongRepeat	Turn on this setting to repeat play a user song or a song on a USB flash drive.	Off, On	28 - 14*
6-3	USB Flash Drive Format	MediaFormat	See page E-49.	-	-
6-4	USB Flash Drive File Delete	FileDelete	See page E-51.	-	-
6-5	USB Flash Drive File Rename	FileRename	See page E-51.	-	-
7	MIDI Group	MIDI			27
7-1	Keyboard Channel	KeyboardCh	Selects the keyboard channel, which is the channel used to send MIDI data corresponding to Digital Piano keyboard play to an external device.	01 to 16	-
7-2	Accomp MIDI Out	AccompOut	Turn on this setting to send MIDI data corresponding to Auto Accompaniment to an external device.	Off, On	-
7-3	MIDI In Chord Judge	ChordJudge	Select whether chord input should be performed when an Auto Accompaniment chord keyboard MIDI note on message is received.	Off, On	-
7-4	Local Control	LocalCtrl	Turn off this setting to have keyboard notes sent to an external device without being sounded by the Digital Piano.	Off, On	-

\* 28 - 13 in this column means, "While holding down 28, press 13."

No.	Parameter	Display Name	Description	Settings	Shortcut Button*
8	Other Parameters Group	General			30
8-1	Display Contrast	Contrast	Adjusts the contrast of the Digital Piano's display.	00 to 26	–
8-2	Panel Lock	PanelLock	Turn on to lock the Digital Piano's control panel to prevent unauthorized or accidental operation. <ul style="list-style-type: none"> <li>This setting is disabled in the Duet Mode, while the recorder is on, or while Auto Accompaniment, a song, or the metronome is playing.</li> </ul>	Off, On	–
8-3	Setting Backup	BackUp	Switching this setting from off to on will save various Digital Piano settings in effect at that time, and restore them the next time the Digital Piano is turned on. <ul style="list-style-type: none"> <li>This operation is disabled in the Duet Mode, while the recorder is on, or while Auto Accompaniment, a song, or the metronome is playing.</li> </ul>	Off, On	–
8-4	Auto Power Off	AutoPower	Specifies if Auto Power Off (page E-5) is enabled (on) or disabled (oFF). Even when "on" is selected for this setting, you can temporarily disable Auto Power Off by holding down the <b>29</b> (FUNCTION) button as you press the <b>1</b> (⏻) button to turn on the Digital Piano.	Off, On	
8-5	Soft/Sostenuto Pedal Jack Setting	Ped.Assign	Specifies whether the pedal unit connected to the SOFT/SOSTENUTO jack is a soft pedal or a sostenuto pedal. <ul style="list-style-type: none"> <li>See page E-15 for details about the two pedal types.</li> </ul>	SFT : Soft pedal SOS : Sostenuto pedal	–
8-6	Half Pedal Effect	HalfPedal	Adjusts the amount of the pedal effect applied when the damper pedal is pressed part way.	00 to 42	–
8-7	Pitch Bend Range	BendRange	Specifies the amount of pitch bend applied when the pitch bend wheel is rotated all the way up or down.	00 to 12 semitones	–

\* **29** – **13** in this column means, "While holding down **29**, press **13**."



# USB Flash Drive

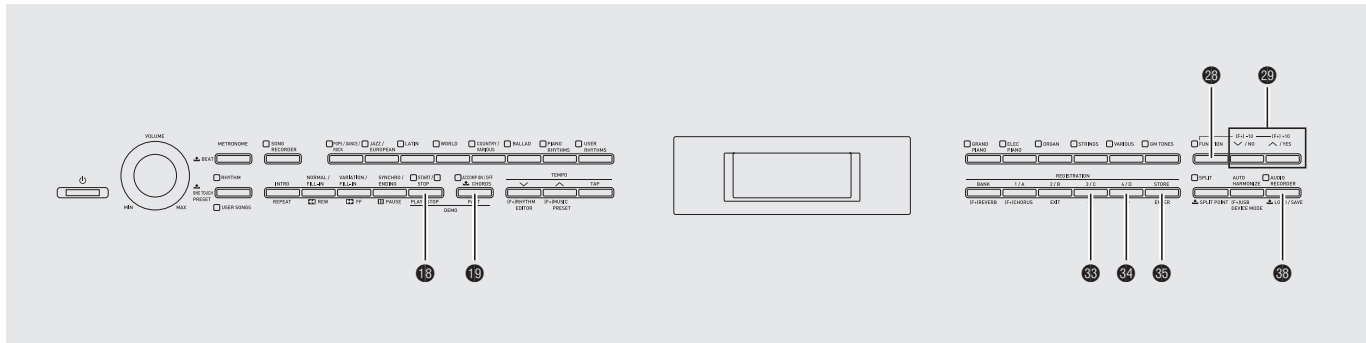

Your Digital Piano supports the following USB flash drive operations.

- USB flash drive formatting
- Data storage to a USB flash drive
  - Song data recorded with the Digital Piano’s song recorder is on a USB flash drive as MIDI files (SMF format 0).
  - Standard audio data from a computer (WAV files) can also be stored on a USB flash drive and played back on the Digital Piano.
  - Digital Piano play can be recorded directly to a USB flash drive.  
For details, see “Recording to a USB Flash Drive (Audio Recorder)” (page E-41).
  - Storage of edited Auto Accompaniment data on a USB flash drive
- USB flash drive data loading to Digital Piano memory
  - MIDI files and CASIO format files stored on a USB flash drive can be loaded into the Digital Piano as user songs (page E-25).
- Delete data from a USB flash drive
- Easy play back of song data from a USB flash drive

## ■ Types of Data

Data Type	Description (File Name Extension)	Supported Operations	
		Save to USB Flash Drive	Load from USB Flash Drive
User rhythms (page E-21)	Auto Accompaniment data edited with this Digital Piano (AC7)	○	○
User songs (page E-25)	One of the following two types of music data 1. CASIO format data (CM2) 2. Standard MIDI files (MID) SMF Format 0 or Format 1	-	○
User Music Presets (page E-29)	Music Preset data edited on this Digital Piano (MPS)	○	○
Recorder songs (page E-35)	Song data recorded on this Digital Piano (CSR)	○*	○
Registration (page E-33)	Tone and rhythm setup settings (CR6)	○	○

\* Can be saved as a standard MIDI file (SMF format 0).

## Storing Standard Audio Data (WAV Files) to a USB Flash Drive

Performing a record operation with the Digital Piano's audio recorder creates a folder named AUDIO on the USB flash drive. WAV files are stored in the AUDIO folder, automatically assigning them names from TAKE01.WAV to TAKE99.WAV. You also can connect a USB flash drive to a computer and change the names of audio data (WAV) files to the format "TAKEXX\*.WAV", and move them to the AUDIO folder. Then you will be able to play them back on the Digital Piano.

\* XX = 01 to 99

## USB Flash Drive and USB Flash Drive Port Handling Precautions

### IMPORTANT!

- Be sure to observe the precautions provided in the documentation that comes with the USB flash drive.
- Avoid using a USB flash drive under the following conditions. Such conditions can corrupt data stored on the USB flash drive.
  - Areas subjected to high temperature, high humidity, or corrosive gas
  - Areas subjected to strong electrostatic charge and digital noise
- Never remove the USB flash drive while data is being written to or loaded from it. Doing so can corrupt the data on the USB flash drive and damage the USB flash drive port.
- Never insert anything besides a USB flash drive into the USB flash drive port. Doing so creates the risk of malfunction.
- A USB flash drive can become warm after very long use. This is normal and does not indicate malfunction.
- Static electricity conducted to the USB flash drive port from your hand or from a USB flash drive can cause malfunction of the Digital Piano. If this happens, turn the Digital Piano off and then back on again.

## Copyrights

You are allowed to use recordings for your own personal use. Any reproduction of an audio or music format file, without the permission of its copyright holder, is strictly prohibited under copyright laws and international treaties. Also, making such files available on the Internet or distributing them to third parties, regardless of whether such activities are conducted with or without compensation, is strictly prohibited under copyright laws and international treaties. CASIO COMPUTER CO., LTD. shall not be held in any way liable for any use of this Digital Piano that is illegal under copyright laws.

## Connecting a USB Flash Drive to and Detaching It from the Digital Piano

### IMPORTANT!

- Never plug any other device besides a USB flash drive into the USB flash drive port.
- When you perform a USB flash drive operation or turn on the Digital Piano while a USB flash drive is plugged in, the Digital Piano initially needs to perform a "mounting" sequence to prepare for data exchange with the USB flash drive. Digital Piano operations are momentarily disabled while a mounting sequence is being performed. While the mounting process is in progress, the message "Media Mounting" will be displayed or "\*\*\*\*\*" will flash on the display. It may take up to 10 or 20 seconds or even longer for a USB flash drive to be mounted. Do not attempt to perform any operation on the Digital Piano while a mounting sequence is in progress. A USB flash drive needs to be mounted each time it is connected to the Digital Piano.

### ■ To insert a USB flash drive

1. As shown in the illustration below, insert the USB flash drive into the Digital Piano's USB flash drive port.
  - Carefully push the USB flash drive in as far as it will go. Do not use undue force when inserting the USB flash drive.

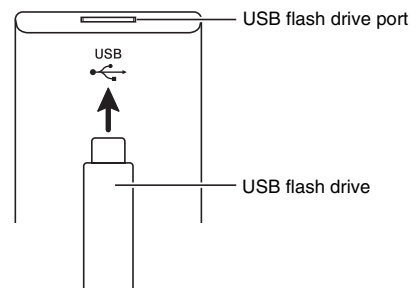

## ■ To remove a USB flash drive

1. Check to confirm that there is no data exchange operation being performed, and then pull the USB flash drive straight out.

## Formatting a USB Flash Drive

### IMPORTANT!

- Be sure to format a USB flash drive on the Digital Piano before using it for the first time.
- Before formatting a USB flash drive, make sure it does not have any valuable data stored on it.
- The format operation performed by this Digital Piano is a “quick format”. If you want to completely delete all of the data in USB flash drive, format it on your computer or some other device.

### <Supported USB Flash Drives>

This Digital Piano supports USB flash drives formatted to FAT32. If your USB flash drive is formatted to a different file system, use the Windows format function to reformat it to FAT32. Do not use quick format.

1. Insert the USB flash drive you want to format into the Digital Piano’s USB flash drive port.
2. Press the **28 (FUNCTION)** button.
3. Press the **38 (AUDIO RECORDER)** button.
4. Press the **34 (>)** button to switch to the “MediaFormat” screen.
5. Press the **35 (ENTER)** button.  
This will display a confirmation message “SURE?”.
  - If you want to cancel the format operation, press the **29 (NO)** or **32 (EXIT)** button.
6. Press the **29 (YES)** button.
  - The message “Please Wait” will remain on the display while the format operation is being performed. Do not perform any Digital Piano operation while this message is on the display. “Complete” appears on the display after formatting is complete.

## Saving Digital Piano Data to a USB Flash Drive

Use the following procedure to save Digital Piano data to a USB flash drive.

- Song Recorder songs can be converted to standard MIDI files (SMF format 0) and saved.
- User songs (downloaded songs, etc.) cannot be saved to a USB flash drive.

1. Insert the USB flash drive into the Digital Piano’s USB flash drive port.
2. Select the data you want to save to the USB flash drive.

To select this type of data:*1	Do this:
User rhythms	Select from among user rhythms 001 through 010 (page E-21).
User Music Preset	Select from among user Music Preset 001 through 050 (page E-29).
Recorder songs	Select from among recorder songs 1 through 5 (page E-35).
Registrations*2	Press the <b>18 (RHYTHM)</b> button so the RHYTHM lamp next to it is lit.

\*1 For more information about data types, see page E-47.

\*2 All registration data (24 banks × 4 areas) is saved in a single file.

3. Hold down the **38 (AUDIO RECORDER)** button until the “LOAD” screen appears for the data you selected.
  - You can cancel the LOAD/SAVE operation any time by pressing the **32 (EXIT)** button.
4. Press the **34 (>)** button to switch to the “SAVE” screen for the data you selected.
  - If you are saving a recorder song to a standard MIDI file (SMF), press the **34 (>)** button again so “SMF” is displayed on the right side of the screen.

5. Use the **29** (∨, ∧) buttons to select the file number (01 to 99) you want to assign to the data when it is saved to the USB flash drive.

- The file number is the final two characters of the file name\* that appears on the display. By changing this within the range of 01 to 99 for each save, up to 99 files of the same data type can be stored on the USB flash drive.

\* The first six characters of the file name indicate the data type as shown below. These characters are fixed and cannot be changed.

Data Type	File Name (** = file number)
User rhythms	USRRHY**
User Music Preset	USRMPS**
Recorder songs	RECSNG**
Registrations	REGIST**

6. Press the **35** (ENTER) button.

- The message “Please Wait” will remain on the display while the save operation is being performed. Do not perform any Digital Piano operation while this message is on the display. “Complete” appears on the display after data save is complete.
- If there is already a file with the same name on the USB flash drive, a message “Replace?” will appear asking if you want to overwrite it with the new data. Press the **29** (YES) button to overwrite or the **28** (NO) button to cancel the save operation.

### ■ USB Flash Drive Data (File) Storage Locations

The above procedure stores Digital Piano data in a data folder on the USB flash drive. The data folder where the data is stored depends on the data type.

Data Type	Data Folder Name
User rhythms	RHYTHMAC
User songs	MUSICLIB
User music presets	MUSICPST
Song recorder songs	RECORDER
Registrations	REGISTMR

- The above data folders are created automatically when you format the USB flash drive on the Digital Piano (page E-49).
- Note that a file not in one of the data folders cannot be loaded, deleted, or renamed by the Digital Piano. You also will not be able to recall, delete, or play any file stored in any subfolder inside one of the data folders.

## Loading Data from a USB Flash Drive to Digital Piano Memory

You can use the procedure below to load data from a USB flash drive into Digital Piano memory.

### IMPORTANT!

- Make sure that the data you want to load is in one of the data folders described under the procedure in the preceding section of this manual. Note that if you put data into a music data play-only folder (such as the PLAY folder), you will not be able to load the file into Digital Piano memory.

1. Insert the USB flash drive into the Digital Piano’s USB flash drive port.

2. Select the data you want to load.

To load this type of data*	Do this:
User rhythms	Select from among user rhythms 001 through 010 (page E-21).
User songs	Select from among user songs 001 through 010 (page E-25).
User Music Preset	Select from among user Music Presets 001 through 050 (page E-29).
Recorder songs	Select from among recorder songs 1 through 5 (page E-35).
Registrations	Press the <b>18</b> (RHYTHM) button so the RHYTHM lamp next to it is lit.

\* For more information about data types, see page E-47.

3. Hold down the **38** (AUDIO RECORDER) button until the “LOAD” screen appears for the data you selected.

- You can cancel the LOAD/SAVE operation any time by pressing the **32** (EXIT) button.

4. Use the **29** (∨, ∧) buttons to select the file you want.

5. Press the **35** (ENTER) button.

- The message “Please Wait” will remain on the display while the load operation is being performed. Do not perform any Digital Piano operation while this message is on the display. “Complete” appears on the display after data loading is complete.
- If there already is a file with the same name in the Digital Piano memory, a message (Replace?) will appear asking if you want to replace it with the new data. Press the **29** (YES) button to overwrite or the **28** (NO) button to cancel the load operation.

## Deleting Data from a USB Flash Drive

Use the following procedure to delete USB flash drive data (files).

1. Insert the USB flash drive into the Digital Piano's USB flash drive port.
2. Press the **28 (FUNCTION)** button.
3. Press the **38 (AUDIO RECORDER)** button.
4. Use the **34 (>)** button to switch to the "FileDelete" screen.
5. Press the **35 (ENTER)** button.  
This displays a screen for selecting data for deletion.
6. Use the **29 (∨, ^)** buttons to select the file you want.
7. Press the **35 (ENTER)** button.  
This will display a confirmation message "SURE?".
  - If you want to cancel the delete operation, press the **29 (NO)** or **32 (EXIT)** button.
8. Press the **29 (YES)** button.
  - The message "Please Wait" will remain on the display while the delete operation is being performed. Do not perform any Digital Piano operation while this message is on the display. "Complete" appears on the display after deletion is complete.

## Renaming a USB Flash Drive File

Use the following procedure to change the file name of a file on a USB flash drive.

1. Insert the USB flash drive into the Digital Piano's USB flash drive port.
2. Press the **28 (FUNCTION)** button.
3. Press the **38 (AUDIO RECORDER)** button.
4. Use the **34 (>)** button to switch to the "FileRename" screen.
5. Press the **35 (ENTER)** button.  
This displays a screen for changing the file name.
6. Use the **29 (∨, ^)** buttons to select the file you want.
7. Use the **34 (>)** and **33 (<)** buttons to move the flashing cursor to the character you want to change, and then use the **29 (∨, ^)** buttons to change the character.
  - The characters you can select are shown below.

0	1	2	3	4	5	6	7	8	9
A	B	C	D	E	F	G	H	I	J
K	L	M	N	O	P	Q	R	S	T
U	V	W	X	Y	Z	\$	&	_	'
(	)	-	^	{	}	@	~	`	

8. After the file name is the way you want, press the **35 (ENTER)** button.  
This will display a confirmation message "SURE?".
  - If you want to cancel the renaming operation, press the **29 (NO)** or **32 (EXIT)** button.
9. Press the **29 (YES)** button.
  - The message "Please Wait" will remain on the display while the rename operation is being performed. Do not perform any Digital Piano operation while this message is on the display. "Complete" appears on the display after renaming is complete.

## Playing Back a Song on a USB Flash Drive

You can use the procedure below to play back a user song (page E-25) stored on a USB flash drive without loading the song into Digital Piano memory.

### ■ USB Flash Drive Folders

Formatting a USB flash drive on the Digital Piano will automatically create a folder named PLAY on the USB flash drive. Also, four folders, named A, B, C, and D, are automatically created inside the PLAY folder. Place any song data you want to play on the Digital Piano into one of the four folders inside the PLAY folder. You can use the four folders to group your music data by family member, genre, or some other categories. Use buttons 31 through 34 (A through D) to select a folder.

Folder Name	Button Assignment
A	31 (A)
B	32 (B)
C	33 (C)
D	34 (D)

1. Store the music data you want to play in one of the USB flash drive folders.
2. Insert the USB flash drive into the Digital Piano's USB flash drive port.
3. While holding down the 23 (FUNCTION) button, press the 33 (AUDIO RECORDER) button.
4. Press one of the folder selection buttons (31 through 34) to select the USB flash drive folder (Folder A through Folder D) you want.  
This will display a song number and song name.
5. Use the 29 (∨, ∧) buttons to select the song you want.
6. Press the 18 (PLAY/STOP) button.  
This will start playback.
  - Each press of 18 (PLAY/STOP) starts and stops playback.
  - Fast forward, fast reverse, tempo changes, and other operations are the same as those during playback of a user song in Digital Piano memory. For details, see "Listening to Songs Loaded from an External Source" (page E-25).
7. To exit the USB flash drive playback mode, hold down the 23 (FUNCTION) button as you press the 33 (AUDIO RECORDER) button.

## Playing Back All of the Songs in a Folder

Use the procedure below to select one of the four folders on a USB flash drive and play back all of the songs in the folder in succession.

1. While holding down the 19 (PART) button, press the 18 (PLAY/STOP) button.

This will start tone demo tune playback (page E-24).

2. While holding down the 23 (FUNCTION) button, press the 33 (AUDIO RECORDER) button.

This will switch from tone demo tune playback to USB flash drive playback.

- While playback is in progress, you can use the 31 through 34 buttons (Folder A through Folder D) to switch playback to another folder.
- To stop playback, press the 18 (START/STOP) button.

## Error Messages

One of the error messages below appears on the display when a problem occurs.

- To clear an error message and return to the normal display, press the **⏏ (EXIT)** button.

Display Message	Cause	Action
<b>No Media</b>	<ol style="list-style-type: none"> <li>1. The USB flash drive is not connected to the Digital Piano's USB flash drive port.</li> <li>2. The USB flash drive was removed while some operation was in progress.</li> <li>3. The USB flash drive is write-protected.</li> <li>4. The USB flash drive has anti-virus software.</li> </ol>	<ol style="list-style-type: none"> <li>1. Correctly plug the USB flash drive into the USB flash drive port.</li> <li>2. Do not remove the USB flash drive while any operation is in progress.</li> <li>3. Unprotect the USB flash drive.</li> <li>4. Use a USB flash drive that does not have anti-virus software.</li> </ol>
<b>No File</b>	There is no loadable file in the "MUSICLIB" folder or no playable file in the "AUDIO" folder.	Move the file you want to load into the "MUSICLIB" folder or the file you want to play into the "AUDIO" folder (pages E-48 and E-49).
<b>No Data</b>	You are attempting to save data to a USB flash drive when there is no data to save.	Record something before performing a save operation.
<b>Read Only</b>	A read-only file with the same name you are trying to use is already stored on USB flash drive.	<ul style="list-style-type: none"> <li>• Change the name and then save the new data.</li> <li>• Remove the read-only attribute from the existing USB flash drive file and overwrite it with the new data.</li> <li>• Use a different USB flash drive.</li> </ul>
<b>Media Full</b>	There is not enough space available on the USB flash drive.	Delete some of the files on the USB flash drive to make room for new data (page E-51) or use a different USB flash drive.
<b>File Full</b>	<ol style="list-style-type: none"> <li>1. There are too many files on the USB flash drive.</li> <li>2. There is a file named TAKE99.WAV in the "AUDIO" folder.</li> </ol>	<ol style="list-style-type: none"> <li>1. Delete some of the files on the USB flash drive to make room for new data.</li> <li>2. Delete the WAV file in the "AUDIO" folder.</li> </ol>
<b>Not SMF01</b>	You are attempting to play back SMF Format 2 song data.	This Digital Piano supports playback of SMF Format 0 or Format 1 only.
<b>Size Over</b>	The data on the USB flash drive is too big to play.	This Digital Piano supports playback of song data files with a maximum size of 320 kbytes.
<b>Wrong Data</b>	<ol style="list-style-type: none"> <li>1. The USB flash drive data is corrupted.</li> <li>2. USB flash drive contains data that is not supported by this Digital Piano.</li> </ol>	—
<b>Convert</b>	There is not enough Digital Piano memory available to convert a song recorder song to SMF data and store it on the USB flash drive.	Reduce the size of the song data. Example: Delete any tracks that are not required.
<b>Format</b>	<ol style="list-style-type: none"> <li>1. The USB flash drive format is not compatible with this Digital Piano.</li> <li>2. The USB flash drive is corrupted.</li> </ol>	<ol style="list-style-type: none"> <li>1. Format the USB flash drive on the Digital Piano.</li> <li>2. Use a different USB flash drive.</li> </ol>
<b>Media R/W</b>	The USB flash drive is corrupted.	Use a different USB flash drive.
<b>File Name</b>	You are attempting to rename a USB flash drive file with a file name that is already used by another file on the USB flash drive.	Rename to a different file name.

# Connecting to a Computer

You can connect the Digital Piano to a computer and exchange MIDI data between them. You can send play data from the Digital Piano to commercially available music software running on your computer, or you can send MIDI data from your computer to the Digital Piano for playback.

## Minimum Computer System Requirements

The following shows the minimum computer system requirements for sending and receiving MIDI data. Check to make sure that your computer complies with these requirements before connecting the Digital Piano to it.

### ● Operating System

Windows® XP (SP2 or later)\*<sup>1</sup>

Windows Vista® \*<sup>2</sup>

Windows® 7 \*<sup>3</sup>

Mac OS® X (10.3.9, 10.4.11, 10.5.X, 10.6.X, 10.7.X)

\*1: Windows XP Home Edition

Windows XP Professional (32-bit)

\*2: Windows Vista (32-bit)

\*3: Windows 7 (32-bit, 64-bit)

### ● USB port

#### IMPORTANT!

- Never connect to a computer that does not conform to the above requirements. Doing so can cause problems with your computer.

## Connecting the Digital Piano to Your Computer

#### IMPORTANT!

- Make sure you follow the steps of the procedure below exactly. Connecting incorrectly can make data send and receive impossible.

1. Turn off the Digital Piano and then start up your computer.
  - Do not start up the music software on your computer yet!
2. After starting up your computer, use a commercially available USB cable to connect it to the Digital Piano.

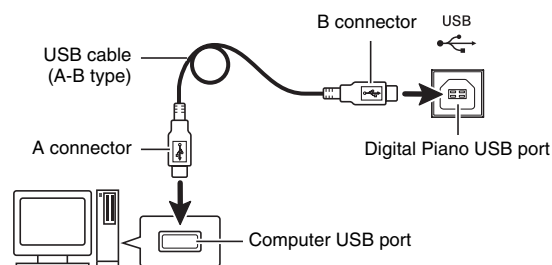

3. Turn on the Digital Piano.
  - If this is the first time you are connecting the Digital Piano to your computer, the driver software required to send and receive data will be installed on your computer automatically.
4. Start up commercially available music software on your computer.
5. Configure the music software settings to select one of the following as the MIDI device.
  - CASIO USB-MIDI : For Windows Vista, Windows 7, Mac OS X
  - USB Audio Device: For Windows XP
  - For information about how to select the MIDI device, see the user documentation that comes with the music software you are using.

#### IMPORTANT!

- Be sure to turn on the Digital Piano first before starting up your computer's music software.



 NOTE

- Once you are able to connect successfully, there is no problem with leaving the USB cable connected when you turn off your computer and/or Digital Piano.
- This Digital Piano conforms to General MIDI Level 1 (GM).
- For detailed specifications and connections that apply to MIDI data send and receive by this Digital Piano, see the latest support information provided by the website at the following URL.  
<http://world.casio.com/>

## Using MIDI

### What is MIDI?

The letters MIDI stand for Musical Instrument Digital Interface, which is the name of a worldwide standard for digital signals and connectors that makes it possible to exchange musical data between musical instruments and computers (machines) produced by different manufacturers.

For details about the MIDI specifications of this Digital Piano, see the “MIDI Implementation” document at the website located at the URL below.

<http://world.casio.com/>

 NOTE

- You can alter the Digital Piano’s MIDI setup by changing the MIDI data send channel or other settings. For details, see “MIDI Group” (page E-45).
- Use a separately available or commercially available MIDI cable to connect the MIDI terminals of your Digital Piano and another electronic musical instrument for exchange of MIDI data.

## Transferring Data between the Digital Piano and a Computer

You can use the procedure below to transfer edited Auto Accompaniment data, recorder data, and other data from the Digital Piano to a computer for storage. You also can transfer standard MIDI files (SMF), as well as Auto Accompaniment data you downloaded from the CASIO website from your computer to Digital Piano memory.

### ■ Data Types Supported for Data Transfer

The types of data that can be stored or imported are the same as those that can be saved to a USB flash drive from the Digital Piano (page E-47).\*

- \* Recorder songs (page E-35) cannot be converted to SMF data for storage on a computer.

 IMPORTANT!

- Turning off the Digital Piano while data is being saved or loaded can cause all data currently stored in Digital Piano memory (recorded songs, etc.) to be deleted. Take care so power is not turned off accidentally during data save and load operations. If data is deleted, it will take longer than normal for the Digital Piano to power up the next time you turn it on (page E-5).

1. Remove the USB flash drive from the Digital Piano’s USB flash drive port (page E-48).
  - You will not be able to transfer data between the Digital Piano and a computer while a USB flash drive is in the USB flash drive port.
2. Perform steps 1 through 3 under “Connecting the Digital Piano to Your Computer” to connect the Digital Piano to your computer (page E-54).

**3.** While holding down the **26 (FUNCTION)** button, press the **37 (USB DEVICE MODE)** button.

This will enter the storage mode, which enables data transfer with the connected computer. The **26 (FUNCTION)** button lamp will flash and the display will appear as shown below.

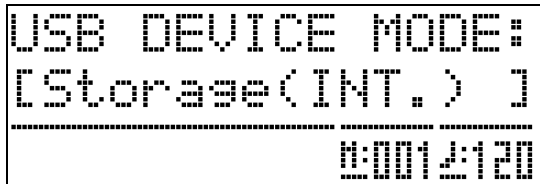

- To exit the storage mode at any time, press the **26 (FUNCTION)** button. This is the only button operation that is supported while the Digital Piano is in the storage mode.
- You will not be able to enter the storage mode while any one of the following operations is in progress. Metronome, Auto Accompaniment, song playback, recorder (on), Auto Accompaniment editing, Music Preset editing, data transfer between the Digital Piano and USB flash drive.

**4.** If your computer is running Windows XP, double-click “My Computer”.\*

Under “Devices with Removable Storage”, you should be able to see a folder representing Digital Piano memory or the USB flash drive loaded in the Digital Piano.

\* Windows Vista, Windows 7: Double-click “Computer”.  
Mac OS: Skip step 4 and double-click “PIANO” on your Mac desktop.

**5.** Double-click “PIANO”.

You now should see five data folders, one for each data type.

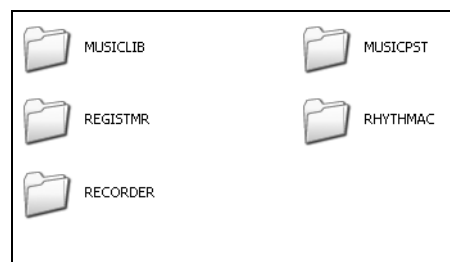

**6.** Referring to the table below, open the folder that corresponds to the type of data you want to transfer.

To load this type of data	Open this data folder	Data File Name
User rhythms (page E-21)	RHYTHMAC	BIDRHYnn.AC7 (nn: 01 to 10) BIDRHYnn.Z00 (nn: 01 to 10) BIDRHYnn.CKF (nn: 01 to 10)
User songs (page E-25)	MUSICLIB	BIDSNGnn.MID (nn: 01 to 10) (SMF Format 0 or Format 1) BIDSNGnn.CM2 (nn: 01 to 10) (CASIO format)
User Music Presets (page E-29)	MUSICPST	BIDMPSnn.MPS (nn: 01 to 50)
Recorder songs (page E-35)	RECORDER	BIDRECnn.CSR (nn: 01 to 05)
Registration (page E-33)	REGISTMR	BIDREGAL.CR6

- Data types and contents are the same as those when saving Digital Piano data to or loading it from a USB Flash Drive. See “USB Flash Drive” (page E-47) for more information.

7. File name extensions (.MID, .CM2, etc.) are not displayed under initial default Windows settings. Perform the procedure below to turn on display of file name extensions.

- (1) Open any one of the folders shown above.
- (2) Perform one of the following operations to display folder information.
  - Windows XP:  
On the [Tools] menu at the top of the folder window, select [Folder Options].
  - Windows Vista, Windows 7:  
On the left side of the folder window, click [Organize] and then select [Folder and Search Options].
- (3) On the Folder Information window, click the [View] tab.
- (4) Under "Advanced Settings", clear the "Hide extensions for known file types" check box and then click [OK].

8. After opening a data folder, perform either of the following operations to transfer data.

8-1. To transfer data from Digital Piano memory to a computer, perform the required operation on your computer to copy the data from the Digital Piano folder you opened in step 6 of this procedure to another location on your computer.

8-2. To load data from your computer to Digital Piano memory, first copy the data you want to load to the data folder you opened. Next, rename the file as shown in the "Data File Name" \* column in the table under step 6 of this procedure.

\* The value you assign for "nn" in the data file name in this case specifies the user number (user rhythm, user song, recorder song, user preset) you want the data to be assigned to.

*Example:* Renaming downloaded song data to BIDSNG04.CM2 to the MUSICLIB folder will make the data user song 004.

9. Press the **FN** (FUNCTION) button to exit the storage mode.

- If you are using a Macintosh, drag the PIANO folder to the Trash and then press the Digital Piano's **FN** (FUNCTION) button.

## ■ Using Auto Accompaniment Data from the CASIO Website

You can download other model Auto Accompaniment data from the "Internet Data Expansion System" of the CASIO Music Site (<http://music.casio.com/>) and transfer it to Digital Piano memory.

### NOTE

- Since the accompaniment data is for other models, you may experience some abnormalities when playing it on this model.

### Copyrights

**The rights of creators and copyright holders of music, images, computer programs, databases, and other data are protected by copyright laws. You are allowed to reproduce such works for personal or non-commercial use only. For any other purpose, all reproduction (including data format conversion), modification, transfer of reproductions, distribution over a network, or any other use without permission of the copyright holder exposes you to claims for damages and criminal prosecution for copyright infringement and violation of the author's personal rights. Be sure to reproduce and otherwise use copyrighted works only in accordance with applicable copyright laws.**

# Reference

## Troubleshooting

Problem	Cause	Action	See Page
No sound is produced when I press a keyboard key.	<ol style="list-style-type: none"> <li>The <b>VOLUME</b> controller is set to "MIN".</li> <li>Headphones or an adaptor plug is plugged into one of the <b>PHONES</b> jacks.</li> </ol>	<ol style="list-style-type: none"> <li>Rotate the <b>VOLUME</b> controller more towards "MAX".</li> <li>Disconnect whatever is connected to the <b>PHONES</b> jack.</li> </ol>	<p>☞ E-5</p> <p>☞ E-6</p>
The pitch of the Digital Piano is off.	<ol style="list-style-type: none"> <li>The Digital Piano's key setting is something other than "440.0 Hz".</li> <li>Digital Piano tuning is incorrect.</li> <li>A non-standard temperament setting is being used.</li> <li>Octave shift is enabled.</li> </ol>	<ol style="list-style-type: none"> <li>Change the key setting to "440.0 Hz", or turn Digital Piano power off and then back on again.</li> <li>Adjust Digital Piano tuning, or turn the Digital Piano off and then back on again.</li> <li>Change the temperament setting to "00:Equal", which is the standard modern tuning.</li> <li>Change the octave shift setting to 0.</li> </ol>	<p>☞ E-44</p> <p>☞ E-44</p> <p>☞ E-44</p> <p>☞ E-11</p>
<p>Tones and/or effects sound strange. Turning power off and then back on again does not eliminate the problem.</p> <p><i>Example: Note intensity does not change even though I alter key pressure.</i></p>	The "Setting Backup" feature is turned on.	Turn off "Setting Backup". Next, turn power off and then back on again.	☞ E-46
I cannot transfer data after connecting the Digital Piano to a computer.	—	<ol style="list-style-type: none"> <li>Check to make sure that the USB cable is connected to the Digital Piano and computer, and that the correct device is selected with your computer's music software.</li> <li>Turn off the Digital Piano and then exit the music software on your computer. Next, turn the Digital Piano back on and then restart the music software on your computer.</li> </ol>	☞ E-54
I cannot record chord accompaniment data on my computer.	Accomp MIDI Out is turned off.	Turn on Accomp MIDI Out.	☞ E-45
I cannot store data to a USB flash drive or load data from a USB flash drive.	—	See "Error Messages".	☞ E-53
Playback stops part way through while transferring song data from my computer.	Digital noise from the USB cable or power cord caused data communication your computer and Digital Piano to be interrupted.	<p>Stop song playback, disconnect the USB cable from the Digital Piano, and then reconnect it. Next, try playing back the song again.</p> <p>If this does not solve the problem, quit the MIDI software you are using, disconnect the USB cable from the Digital Piano, and then reconnect it. Next, restart the MIDI software and then try playing back the song again.</p>	☞ E-54
A tone's quality and volume sounds slightly different depending where it is played on the keyboard.	<p>This is an unavoidable result of the digital sampling process,* and does not indicate malfunction.</p> <p>* Multiple digital samples are taken for the low range, middle range, and high range of the original musical instrument. Because of this, there may be a very slight difference in tonal quality and volume between sample ranges.</p>		
When I press a button, the note that is sounding cuts out momentarily or there is a slight change in how effects are applied.	Performing a button operation while playing with the Duet Mode, Auto Accompaniment, the recorder, or other functions can cause such phenomena when the Digital Piano switches internal tone effects. It does not indicate malfunction.		

Problem	Cause	Action	See Page
<b>Even though I play on different ranges of the keyboard, the notes do not change octaves.</b>	The ranges of certain tones are limited, which means that octaves change normally up to a certain low note or high note. With such a tone, the notes of the lowest octave will be repeated to the left of the lowest possible note, and the highest octave will be repeated to the right of the highest possible note. This is due do limitations in the range of the original musical instrument for each tone, and does not indicate malfunction of the Digital Piano.		

## Product Specifications

Model	PX-350MBK/PX-350MWE
Keyboard	88-key piano keyboard, with Touch Response (3 types)
Maximum Polyphony	128 notes
Tones	250 (with Layer and Split)
Effects	Reverb (4 types), Chorus (4 types), Brilliance (–3 to 0 to 3), Damper Resonance
Metronome	<ul style="list-style-type: none"> <li>• Beats per measure: 0, 2, 3, 4, 5, 6</li> <li>• Tempo Range: 20 to 255</li> </ul>
Duet	Adjustable tone range: 0 to 3 octaves for the left keyboard; –4 to –1 octaves for the right keyboard
Auto Accompaniment	<ul style="list-style-type: none"> <li>• Built-in Rhythms: 180</li> <li>• User Rhythms: Up to 10 (Approximately 40KB* maximum per rhythm)</li> <li>• One Touch Presets: 180 types</li> <li>• Auto Harmonize: 12 types</li> </ul>
Demo Songs	6 songs (tone demo songs)
User Songs	Up to 10 songs (320KB* maximum per song)
Music Presets	Built-in Presets: 300 User Presets: Up to 50 (Approximately 8KB* maximum per preset)
Registration	96 (4 setups × 24 banks)
Song Recorder	<ul style="list-style-type: none"> <li>• Functions: Real-time recording, playback</li> <li>• Number of Songs: 5</li> <li>• Number of Tracks: 17 (System Track + Tracks 01 through 16)</li> <li>• Capacity: Approximately 50,000 notes total (Up to approximately 10,000 notes per song)</li> <li>• Punch-in recording</li> </ul>
Audio Recorder	<ul style="list-style-type: none"> <li>• Real-time recording and playback to USB flash drive* * Linear PCM, 16bit, 44.1 kHz, stereo .WAV format</li> <li>• Songs: 99 files</li> <li>• Approximately 25 minutes maximum recording per file.</li> </ul>
Pedals	Damper, Soft/Sostenuto (switchable)
Other Functions	<ul style="list-style-type: none"> <li>• Transpose: ±1 octave (–12 to 00 to 12)</li> <li>• Tuning: A4 = 415.5 Hz to 440.0 Hz to 465.9 Hz</li> <li>• Octave Shift: ±2 octaves</li> <li>• Temperaments: 17 types</li> <li>• Stretch Tune</li> <li>• Panel Lock</li> </ul>
MIDI	16 multi-timbre received, GM Level 1 standard
Pitch Bend Wheel	Pitch Bend Range: 00 to 12 semitones
USB Flash Drive	SMF playback, data storage, data loading, USB flash drive format, playback of audio data
Inputs/Outputs	<ul style="list-style-type: none"> <li>• <b>PHONES</b> jacks: Stereo standard jacks × 2</li> <li>• Pedal Jacks: Standard jacks × 2</li> <li>• <b>MIDI OUT/IN</b> terminals</li> <li>• <b>LINE OUT R, L/MONO</b> jacks: Standard jacks × 2 Output impedance: 2.3KΩ Output voltage: 1.8V (RMS) MAX</li> <li>• <b>LINE IN R, L/MONO</b> jacks: Standard jacks × 2 Input impedance: 9.0KΩ Input voltage: 200mV</li> <li>• Power: 12V DC</li> <li>• USB port: Type B</li> <li>• USB flash drive port : Type A</li> <li>• Pedal connector (for optional SP-33 only)</li> </ul>

Speakers	[13cm × 6cm (rectangular)] × 2 + $\phi$ 5cm × 2 (Output: 8.0W + 8.0W)
Power Requirements	AC Adaptor: AD-A12150LW • Auto Power Off: Approximately 4 hours after last operation. Auto Power Off can be disabled.
Power Consumption	12V $\approx$ 18W
Dimensions	132.2 (W) × 28.6 (D) × 13.5 (H) cm (52 $\frac{1}{16}$ × 11 $\frac{1}{4}$ × 5 $\frac{5}{16}$ inch)
Weight	Approximately 11.6kg (25.6lbs)

\* Based on 1KB = 1024bytes, 1MB = 1024<sup>2</sup> bytes

- Specifications and designs are subject to change without notice.

## Operating Precautions

Be sure to read and observe the following operating precautions.

### ■ Location

Avoid the following locations for this product.

- Areas exposed to direct sunlight and high humidity
- Areas subjected to temperature extremes
- Near a radio, TV, video deck, or tuner
- The above devices will not cause malfunction of the product, but the product can cause interference in the audio or video of a nearby device.

### ■ User Maintenance

- Never use benzine, alcohol, thinner, or other chemical agents to clean the product.
- To clean the product or its keyboard, wipe with a soft cloth moistened in a weak solution of water and a mild neutral detergent. Wring all excess moisture from the cloth before wiping.

### ■ Included and Optional Accessories

Use only accessories that are specified for use with this product. Use of unauthorized accessories creates the risk of fire, electric shock, and personal injury.

### ■ Weld Lines

Lines may be visible on the exterior of the product. These are "weld lines" that result from the plastic molding process. They are not cracks or scratches.

### ■ Musical Instrument Etiquette

Always be aware of others around you whenever using this product. Be especially careful when playing late at night to keep the volume at levels that do not disturb others. Other steps you can take when playing late at night are closing windows and using headphones.

- Any reproduction of the contents of this manual, either in part or its entirety, is prohibited. Except for your own, personal use, any other use of the contents of this manual without the consent of CASIO is prohibited under copyright laws.
- IN NO EVENT SHALL CASIO BE LIABLE FOR ANY DAMAGES WHATSOEVER (INCLUDING, WITHOUT LIMITATION, DAMAGES FOR LOSS OF PROFITS, BUSINESS INTERRUPTION, LOSS OF INFORMATION) ARISING OUT OF THE USE OF OR INABILITY TO USE THIS MANUAL OR PRODUCT, EVEN IF CASIO HAS BEEN ADVISED OF THE POSSIBILITY OF SUCH DAMAGES.
- The contents of this manual are subject to change without notice.

### ■ AC Adaptor Handling Precautions

- Use a power outlet that is easily accessible so you can unplug the AC adaptor when a malfunction occurs or whenever else you need to do so.
- The AC adaptor is intended for indoor use only. Do not use it where it might be exposed to splashing or moisture. Do not place any container, such as a flower vase, that contains liquid on the AC adaptor.
- Store the AC adaptor in a dry place.
- Use the AC adaptor in an open, well-ventilated area.
- Never cover the AC adaptor with newspaper, a table cloth, a curtain, or any other similar item.
- Unplug the AC adaptor from the power outlet if you do not plan to use the Digital Piano for a long time.
- Never try to repair the AC adaptor or modify it in any way.
- AC adaptor operating environment  
Temperature: 0 to 40°C  
Humidity: 10% to 90% RH

Output polarity: 



## AC Adaptor Handling Precautions

### Model: AD-A12150LW

1. Read these instructions.
2. Keep these instructions on hand.
3. Heed all warnings.
4. Follow all instructions.
5. Do not use this product near water.
6. Clean only with a dry cloth.
7. Do not install near radiators, heat registers, stoves, or any other source of heat (including amplifiers).
8. Use only attachments and accessories specified by the manufacturer.
9. Refer all servicing to qualified service personnel. Servicing is required after any of the following occurs: when the product is damaged, when the power supply cord or plug is damaged, when liquid is spilled into the product, when a foreign object falls into the product, when the product is exposed to rain or moisture, when the product does not operate normally, when the product is dropped.
10. Do not allow the product to be exposed to dripping or splashing liquid. Do not place any object containing liquid on the product.
11. Do not allow the electrical load output to exceed the label rating.
12. Make sure the surrounding area is dry before plugging into a power source.
13. Make sure the product is oriented correctly.
14. Unplug the product during lightning storms or when you do not plan to use it for a long time.
15. Do not allow product ventilation openings to become blocked. Install the product in accordance with the manufacturer's instructions.
16. Take care the power cord is located where it will not be stepped upon or bent severely, particularly in locations close to plugs and convenience receptacles, and in locations where it exits from the product.
17. The AC adaptor should be plugged into a power outlet as close to the product as possible to allow immediate disconnection of the plug in case of emergency.

The symbol below is an alert indicating un-insulated hazardous voltage inside the product's enclosure, which may be sufficient to constitute the risk of electric shock to users.



The symbol below is an alert indicating the presence of important operating and maintenance (servicing) instructions in the documentation that accompanies the product.



# Appendix/Apéndice

## Tone List/Lista de tonos

Group Name/ Nombre del grupo	Group Number/ Número de grupo	Sequential Number/ Número secuencial	Tone Name/ Nombre del tono	Program Change/ Cambio de programa	Bank Select MSB/ MSB de selección de banco
<b>GRAND PIANO</b>					
	001	001	GRAND PIANO CONCERT	0	48
	002	002	GRAND PIANO STUDIO	0	54
	003	003	GRAND PIANO MODERN	0	49
	004	004	GRAND PIANO CLASSIC	0	50
	005	005	GRAND PIANO BRIGHT	1	52
	006	006	GRAND PIANO MELLOW	0	51
	007	007	GRAND PIANO DOLCE	0	55
	008	008	ROCK PIANO	1	48
	009	009	LA PIANO	1	49
	010	010	DANCE PIANO	1	51
	011	011	HONKY-TONK	3	48
	012	012	OCTAVE PIANO	3	49
	013	013	STRINGS PIANO	0	52
	014	014	PIANO PAD	0	53
<b>ELEC PIANO</b>					
	001	015	ELEC.PIANO 1	4	48
	002	016	ELEC.PIANO 2	5	48
	003	017	60'S E.PIANO	4	51
	004	018	E.GRAND 80	2	48
	005	019	DYNO ELEC.PIANO	4	49
	006	020	FM ELEC.PIANO	5	49
	007	021	MELLOW E.PIANO	4	50
	008	022	POP ELEC.PIANO	5	50
	009	023	CHORUS E.PIANO	4	53
	010	024	SYNTH-STR.E.PIANO	4	52
	011	025	VIBRAPHONE	11	48
	012	026	CLAVI	7	48
	013	027	WAH CLAVI	7	49
	014	028	HARPSICHORD	6	48
	015	029	COUPLED HARPSICHORD	6	49
	016	030	MARIMBA	12	48
	017	031	CHORUS VIBRAPHONE	11	49
<b>ORGAN</b>					
	001	032	ROCK ORGAN 1	16	49
	002	033	JAZZ ORGAN	17	48
	003	034	DRAWBAR ORGAN	16	48
	004	035	ROTARY DRAWBAR	16	50
	005	036	ROTARY ORGAN	16	51
	006	037	PERC.ORGAN	17	49
	007	038	70'S ORGAN	17	50
	008	039	OVERDRIVE ORGAN	16	52
	009	040	TREMOLO ORGAN	16	53
	010	041	ROCK ORGAN 2	18	48
	011	042	ELEC.ORGAN	16	54
	012	043	FULL DRAWBAR	16	55
	013	044	CHURCH ORGAN	19	48
	014	045	CHAPEL ORGAN	19	49
<b>STRINGS</b>					
	001	046	STEREO STRINGS 1	49	48
	002	047	STEREO STRINGS 2	48	49
	003	048	STRING ENSEMBLE	48	48
	004	049	SYNTH-STRINGS	50	48
	005	050	70'S SYNTH-STR.	50	49
	006	051	80'S SYNTH-STR.	50	50
	007	052	VIOLIN SECTION	40	48
	008	053	CHOIR	52	48
	009	054	SYNTH-VOICE	54	48
	010	055	SYNTH-PAD	90	48
	011	056	FANTASY	88	48
	012	057	NEW AGE	88	49
	013	058	WARM PAD	89	48
	014	059	WARM VOX	89	49
	015	060	POLYSYNTH PAD	90	49
	016	061	ATMOSPHERE PAD	99	48

Group Name/ Nombre del grupo	Group Number/ Número de grupo	Sequential Number/ Número secuencial	Tone Name/ Nombre del tono	Program Change/ Cambio de programa	Bank Select MSB/ MSB de selección de banco
<b>VARIOUS</b>					
	001	062	ACOUSTIC BASS	32	48
	002	063	RIDE BASS	32	49
	003	064	FINGERED BASS 1	33	48
	004	065	FINGERED BASS 2	33	49
	005	066	FINGERED BASS 3	33	50
	006	067	PICKED BASS	34	48
	007	068	TRANCE BASS	38	48
	008	069	NYLON STR.GUITAR	24	48
	009	070	STEEL STR.GUITAR 1	25	48
	010	071	STEEL STR.GUITAR 2	25	49
	011	072	STEEL STR.GUITAR 3	25	50
	012	073	JAZZ GUITAR	26	48
	013	074	CLEAN GUITAR	27	49
	014	075	CHORUS CLEAN GUITAR	27	48
	015	076	CRUNCH ELEC.GUITAR 1	27	50
	016	077	CRUNCH ELEC.GUITAR 2	27	51
	017	078	OVERDRIVE GUITAR	29	48
	018	079	BREATHY ALTO SAX	65	49
	019	080	BREATHY TENOR SAX	66	49
	020	081	ALTO SAX	65	48
	021	082	TENOR SAX	66	48
	022	083	CLARINET	71	48
	023	084	FLUTE	73	48
	024	085	TRUMPET	56	48
	025	086	TROMBONE	57	48
	026	087	STEREO BRASS	61	48
	027	088	BRASS SECTION	61	49
	028	089	SYNTH-BRASS	62	48
	029	090	80'S SYNTH-BRASS	62	49
	030	091	SAW LEAD	81	48
	031	092	MELLOW SAW LEAD	81	49
	032	093	SQUARE LEAD	80	48
	033	094	ER HU	110	56
	034	095	YANG QIN	15	56
	035	096	ZHENG	107	56
	036	097	PI PA	105	56
	037	098	DI ZI	72	56
	038	099	XIAO	77	56
	039	100	SHENG	109	56
	040	101	SITAR	104	56
	041	102	TANPURA	104	57
	042	103	HARMONIUM	20	56
	043	104	SANTUR	15	58
	044	105	SHANAI	111	56
	045	106	KANUN	15	59
	046	107	ODD	105	59
	047	108	NEY	72	57
<b>GM TONES</b>					
	001	109	GM PIANO 1	0	0
	002	110	GM PIANO 2	1	0
	003	111	GM PIANO 3	2	0
	004	112	GM HONKY-TONK	3	0
	005	113	GM E.PIANO 1	4	0
	006	114	GM E.PIANO 2	5	0
	007	115	GM HARPSICHORD	6	0
	008	116	GM CLAVI	7	0
	009	117	GM CELESTA	8	0
	010	118	GM GLOCKENSPIEL	9	0
	011	119	GM MUSIC BOX	10	0
	012	120	GM VIBRAPHONE	11	0
	013	121	GM MARIMBA	12	0
	014	122	GM XYLOPHONE	13	0
	015	123	GM TUBULAR BELL	14	0
	016	124	GM DULCIMER	15	0
	017	125	GM ORGAN 1	16	0

Group Name/ Nombre del grupo	Group Number/ Número de grupo	Sequential Number/ Número secuencial	Tone Name/ Nombre del tono	Program Change/ Cambio de programa	Bank Select MSB/ MSB de selección de banco
	018	126	GM ORGAN 2	17	0
	019	127	GM ORGAN 3	18	0
	020	128	GM PIPE ORGAN	19	0
	021	129	GM REED ORGAN	20	0
	022	130	GM ACCORDION	21	0
	023	131	GM HARMONICA	22	0
	024	132	GM BANDONEON	23	0
	025	133	GM NYLON STR.GUITAR	24	0
	026	134	GM STEEL STR.GUITAR	25	0
	027	135	GM JAZZ GUITAR	26	0
	028	136	GM CLEAN GUITAR	27	0
	029	137	GM MUTE GUITAR	28	0
	030	138	GM OVERDRIVE GT	29	0
	031	139	GM DISTORTION GT	30	0
	032	140	GM GT HARMONICS	31	0
	033	141	GM ACOUSTIC BASS	32	0
	034	142	GM FINGERED BASS	33	0
	035	143	GM PICKED BASS	34	0
	036	144	GM FRETLESS BASS	35	0
	037	145	GM SLAP BASS 1	36	0
	038	146	GM SLAP BASS 2	37	0
	039	147	GM SYNTH-BASS 1	38	0
	040	148	GM SYNTH-BASS 2	39	0
	041	149	GM VIOLIN	40	0
	042	150	GM VIOLA	41	0
	043	151	GM CELLO	42	0
	044	152	GM CONTRABASS	43	0
	045	153	GM TREMOLO STRINGS	44	0
	046	154	GM PIZZICATO	45	0
	047	155	GM HARP	46	0
	048	156	GM TIMPANI	47	0
	049	157	GM STRINGS 1	48	0
	050	158	GM STRINGS 2	49	0
	051	159	GM SYNTH-STRINGS 1	50	0
	052	160	GM SYNTH-STRINGS 2	51	0
	053	161	GM CHOIR AAHS	52	0
	054	162	GM VOICE DOO	53	0
	055	163	GM SYNTH-VOICE	54	0
	056	164	GM ORCHESTRA HIT	55	0
	057	165	GM TRUMPET	56	0
	058	166	GM TROMBONE	57	0
	059	167	GM TUBA	58	0
	060	168	GM MUTE TRUMPET	59	0
	061	169	GM FRENCH HORN	60	0
	062	170	GM BRASS	61	0
	063	171	GM SYNTH-BRASS 1	62	0
	064	172	GM SYNTH-BRASS 2	63	0
	065	173	GM SOPRANO SAX	64	0
	066	174	GM ALTO SAX	65	0
	067	175	GM TENOR SAX	66	0
	068	176	GM BARITONE SAX	67	0
	069	177	GM OBOE	68	0
	070	178	GM ENGLISH HORN	69	0
	071	179	GM BASSOON	70	0
	072	180	GM CLARINET	71	0
	073	181	GM PICCOLO	72	0
	074	182	GM FLUTE	73	0
	075	183	GM RECORDER	74	0
	076	184	GM PAN FLUTE	75	0
	077	185	GM BOTTLE BLOW	76	0
	078	186	GM SHAKUHACHI	77	0
	079	187	GM WHISTLE	78	0
	080	188	GM OCARINA	79	0
	081	189	GM SQUARE LEAD	80	0
	082	190	GM SAW LEAD	81	0
	083	191	GM CALLIOPE	82	0
	084	192	GM CHIFF LEAD	83	0
	085	193	GM CHARANG	84	0
	086	194	GM VOICE LEAD	85	0
	087	195	GM FIFTH LEAD	86	0
	088	196	GM BASS+LEAD	87	0
	089	197	GM FANTASY	88	0

Group Name/ Nombre del grupo	Group Number/ Número de grupo	Sequential Number/ Número secuencial	Tone Name/ Nombre del tono	Program Change/ Cambio de programa	Bank Select MSB/ MSB de selección de banco
	090	198	GM WARM PAD	89	0
	091	199	GM POLYSYNTH	90	0
	092	200	GM SPACE CHOIR	91	0
	093	201	GM BOWED GLASS	92	0
	094	202	GM METAL PAD	93	0
	095	203	GM HALO PAD	94	0
	096	204	GM SWEEP PAD	95	0
	097	205	GM RAIN DROP	96	0
	098	206	GM SOUND TRACK	97	0
	099	207	GM CRYSTAL	98	0
	100	208	GM ATMOSPHERE	99	0
	101	209	GM BRIGHTNESS	100	0
	102	210	GM GOBLINS	101	0
	103	211	GM ECHOES	102	0
	104	212	GM SF	103	0
	105	213	GM SITAR	104	0
	106	214	GM BANJO	105	0
	107	215	GM SHAMISEN	106	0
	108	216	GM KOTO	107	0
	109	217	GM THUMB PIANO	108	0
	110	218	GM BAGPIPE	109	0
	111	219	GM FIDDLE	110	0
	112	220	GM SHANAI	111	0
	113	221	GM TINKLE BELL	112	0
	114	222	GM AGOGO	113	0
	115	223	GM STEEL DRUMS	114	0
	116	224	GM WOOD BLOCK	115	0
	117	225	GM TAIKO	116	0
	118	226	GM MELODIC TOM	117	0
	119	227	GM SYNTH-DRUM	118	0
	120	228	GM REVERSE CYMBAL	119	0
	121	229	GM GT FRET NOISE	120	0
	122	230	GM BREATH NOISE	121	0
	123	231	GM SEASHORE	122	0
	124	232	GM BIRD	123	0
	125	233	GM TELEPHONE	124	0
	126	234	GM HELICOPTER	125	0
	127	235	GM APPLAUSE	126	0
	128	236	GM GUNSHOT	127	0
	129	237	STANDARD SET 1	0	120
	130	238	STANDARD SET 2	1	120
	131	239	STANDARD SET 3	2	120
	132	240	STANDARD SET 4	3	120
	133	241	ROOM SET	8	120
	134	242	HIP-HOP SET	9	120
	135	243	POWER SET	16	120
	136	244	ELECTRONIC SET	24	120
	137	245	SYNTH SET 1	25	120
	138	246	SYNTH SET 2	30	120
	139	247	TRANCE SET	31	120
	140	248	JAZZ SET	32	120
	141	249	BRUSH SET	40	120
	142	250	ORCHESTRA SET	48	120

 **NOTE**

- While sequential numbered tone 071 (STEEL STR.GUITAR 2) or 072 (STEEL STR.GUITAR 3) is selected, pressing multiple keys on the far left side of the keyboard will produce a guitar strumming sound. It does not indicate malfunction.
- See the "Drum Assignment List" (page A-4) for the percussion instrument assigned to each keyboard key when a drum set (Sequential Number 237 to 250) is selected.

 **NOTA**

- Si presiona múltiples teclas en el extremo izquierdo del teclado mientras están seleccionados los tonos secuenciales número 071 (STEEL STR. GUITAR 2) o 072 (STEEL STR. GUITAR 3), producirá un sonido de rasgueo de guitarra. Esto no es ningún signo de anomalía.
- Consulte la "Lista de asignación de batería" (página A-4) para saber cuáles son los instrumentos de percusión asignados a cada tecla cuando se selecciona un ajuste de batería (números secuenciales 237 a 250).

## Drum Assignment List/Lista de asignación de batería

Key/Note Number Número de clave/nota	STANDARD SET 1	STANDARD SET 2	STANDARD SET 3	STANDARD SET 4	ROOM SET	HIP-HOP SET	POWER SET	ELECTRONIC SET	SYNTH SET 1	SYNTH SET 2	TRANCE SET	JAZZ SET	BRUSH SET	ORCHESTRA SET
E1 28	High Q	←	←	←	←	←	←	←	←	←	←	←	←	Closed Hi-Hat
F1 29	Slap	←	←	←	←	←	←	←	←	←	←	←	←	Pedal Hi-Hat
F1 29	Scratch Push	←	←	←	←	←	←	←	←	←	←	←	←	Open Hi-Hat
G1 31	Scratch Pull	←	←	←	←	←	←	←	←	←	←	←	←	Ride Cymbal 1
A1 33	Sticks	←	←	←	←	←	←	←	←	←	←	←	←	←
A1 33	Square Click	←	←	←	←	←	←	←	←	←	←	←	←	←
B1 35	Metronome Click	←	←	←	←	←	←	←	←	←	←	←	←	←
B1 35	Metronome Bell	←	←	←	←	←	←	←	←	←	←	←	←	←
C2 36	Standard1 Kick 1	Standard2 Kick 2	Standard3 Kick 2	Standard4 Kick 2	Room Kick 2	Hip-Hop Kick 2	Power Kick 2	Elec. Kick 2	Synth1 Kick 2	Synth2 Kick 2	Trance Kick 2	Jazz Kick 2	Brush Kick 2	Jazz Kick 1
C2 37	Standard1 Kick 1	Standard2 Kick 1	Standard3 Kick 1	Standard4 Kick 1	Room Kick 1	Hip-Hop Kick 1	Power Kick 1	Elec. Kick 1	Synth1 Kick 1	Synth2 Kick 1	Trance Kick 1	Jazz Kick 1	Brush Kick 1	Concert BD
D2 38	Standard1 Snare 1	Standard2 Snare 1	Standard3 Snare 1	Standard4 Snare 1	Room Snare 1	Hip-Hop Snare 1	Power Snare 1	Elec. Snare 1	Synth1 Snare 1	Synth2 Snare 1	Trance Snare 1	Jazz Snare 1	Brush Snare 1	Concert SD
E2 40	Hand Clap	←	Standard3 Hand Clap	←	←	Hip-Hop Hand Clap	←	←	Synth1 Hand Clap	←	Trance Hand Clap	←	Brush Slap	Castanets
F2 41	Standard1 Snare 2	Standard2 Snare 2	Standard3 Snare 2	Standard4 Snare 2	Room Snare 2	Hip-Hop Snare 2	Power Snare 2	Elec. Snare 2	Synth1 Snare 2	Synth2 Snare 2	Trance Snare 2	Jazz Snare 2	Brush Snare 2	Concert SD
F2 42	Closed Hi-Hat	Standard2 Closed Hi-Hat	Standard3 Closed Hi-Hat	Standard4 Closed Hi-Hat	Room Low Tom 1	Hip-Hop Closed Hi-Hat	Room Low Tom 2	Elec. Low Tom 2	Synth1 Low Tom 2	Synth2 Low Tom 2	Trance Closed Hi-Hat	←	←	Timpani F
G2 43	Pedal Hi-Hat	Standard2 Pedal Hi-Hat	Standard3 Pedal Hi-Hat	Standard4 Pedal Hi-Hat	Room Low Tom 1	←	←	←	Synth1 Low Tom 1	Synth2 Low Tom 1	←	←	←	Timpani G
A2 45	Mid Tom 2	Standard2 Mid Tom 2	Standard3 Mid Tom 2	Standard4 Mid Tom 2	Room Mid Tom 2	←	←	←	Synth1 Mid Tom 2	Synth2 Mid Tom 2	←	←	←	Timpani G
B2 46	Open Hi-Hat	Standard2 Open Hi-Hat	Standard3 Open Hi-Hat	Standard4 Open Hi-Hat	Room Mid Tom 1	Hip-Hop Open Hi-Hat	Room Mid Tom 1	Elec. Mid Tom 1	Synth1 Mid Tom 1	Synth2 Mid Tom 1	←	←	←	Timpani A
C3 48	High Tom 2	Standard2 High Tom 2	Standard3 High Tom 2	Standard4 High Tom 2	Room High Tom 2	←	←	←	Synth1 High Tom 2	Synth2 High Tom 2	←	←	←	Timpani A
C3 48	Crash Cymbal 1	←	←	←	Room High Tom 1	←	←	←	Synth1 High Tom 1	Synth2 High Tom 1	←	←	←	Timpani B
D3 50	High Tom 1	←	←	←	←	←	←	←	Synth1 High Tom 1	←	←	←	←	Timpani c
E3 52	Ride Cymbal 1	←	←	←	←	←	←	Reverse Cymbal	Synth1 Ride Cymbal	←	←	←	Brush Crash Cymbal 1	Timpani c
F3 53	Chinese Cymbal	←	←	←	←	←	←	←	←	←	←	←	Brush Ride Cymbal 1	Timpani d
F3 53	Ride Bell	←	←	←	←	←	←	←	←	←	←	←	Brush Ride Bell	Timpani e
G3 55	Tambourine	←	←	←	←	←	←	←	Synth1 Tambourine	←	Trance Tambourine	←	Brush Tambourine	Timpani f
G3 55	Splash Cymbal	←	←	←	←	←	←	←	←	←	←	←	Brush Splash Cymbal	←
A3 57	Cowbell	←	←	←	←	←	←	←	Synth1 Cowbell	Synth1 Cowbell	←	←	←	←
A3 57	Crash Cymbal 2	←	←	←	←	←	←	←	←	←	←	←	←	←
B3 58	Vibraslap	←	←	←	←	←	←	←	←	←	←	←	←	←
B3 59	Ride Cymbal 2	←	←	←	←	←	←	←	←	←	←	←	←	←
C4 60	High Bongo	←	←	←	←	←	←	←	←	←	←	←	←	←
C4 61	Low Bongo	←	←	←	←	←	←	←	←	←	←	←	←	←
D4 62	Mute High Conga	←	←	←	←	←	←	←	Synth1 High Bongo	←	←	←	←	←
E4 64	Open High Conga	←	←	←	←	←	←	←	Synth1 Low Bongo	←	←	←	←	←
F4 65	Open Low Conga	←	←	←	←	←	←	←	Synth1 Mute Hi Conga	←	←	←	←	←
F4 65	High Timbale	←	←	←	←	←	←	←	Synth1 Open Hi Conga	←	←	←	←	←
G4 67	Low Timbale	←	←	←	←	←	←	←	Synth1 Open Low Conga	←	←	←	←	←
A4 69	High Agogo	←	←	←	←	←	←	←	←	←	←	←	←	←
A4 69	Low Agogo	←	←	←	←	←	←	←	←	←	←	←	←	←
B4 70	Cabasa	←	←	←	←	←	←	←	←	←	←	←	←	←
B4 71	Maracas	←	←	←	←	←	←	←	Synth1 Maracas	Synth1 Maracas	←	←	←	←
C5 72	Short High Whistle	←	←	←	←	←	←	←	←	←	←	←	←	←
C5 72	Long Low Whistle	←	←	←	←	←	←	←	←	←	←	←	←	←
D5 74	Short Guiro	←	←	←	←	←	←	←	←	←	←	←	←	←
E5 75	Long Guiro	←	←	←	←	←	←	←	←	←	←	←	←	←
E5 76	Claves	←	←	←	←	←	←	←	←	←	←	←	←	←
F5 77	High Wood Block	←	←	←	←	←	←	←	←	←	←	←	←	←
F5 77	Low Wood Block	←	←	←	←	←	←	←	←	←	←	←	←	←
G5 79	Mute Cuica	←	←	←	←	←	←	←	←	←	←	←	←	←
A5 81	Open Cuica	←	←	←	←	←	←	←	←	←	←	←	←	←
A5 81	Mute Triangle	←	←	←	←	←	←	←	←	←	←	←	←	←
B5 83	Open Triangle	←	←	←	←	←	←	←	Synth1 Claves	Synth1 Claves	←	←	←	←
B5 83	Shaker	←	←	←	←	←	←	←	←	←	←	←	←	←
C6 84	Jingle Bell	←	←	←	←	←	←	←	←	←	←	←	←	←
C6 84	Bell Tree	←	←	←	←	←	←	←	←	←	←	←	←	←
C6 85	Castanets	←	←	←	←	←	←	←	←	←	←	←	←	←
D6 86	Mute Surdo	←	←	←	←	←	←	←	←	←	←	←	←	←
E6 88	Open Surdo	←	←	←	←	←	←	←	←	←	←	←	←	←
F6 89	Applause 1	←	←	←	←	←	←	←	←	←	←	←	←	←
F6 89	Applause 2	←	←	←	←	←	←	←	←	←	←	←	←	←

• “←” indicates a key is assigned the same tones as it is for STANDARD SET 1.

• “←” indica una clave asignada a los mismos tonos que para STANDARD SET 1.

## Rhythm List/Lista de ritmos

Group Name/ Nombre del grupo	Group Number/ Número de grupo	Sequential Number/ Número secuencial	Rhythm name/ Nombre del ritmo
<b>POPS/DANCE/ROCK</b>			
POPS			
001	001	POP	
002	002	ACOUSTIC GUITAR POP	
003	003	FAST POP	
004	004	FUNK POP	
005	005	POP ROCK	
006	006	6/8 POP	
007	007	FAST SOUL	
008	008	SLOW SOUL	
009	009	60's SOUL	
010	010	POP SHUFFLE	
8 BEAT/16 BEAT			
011	011	STRAIGHT 8 BEAT 1	
012	012	STRAIGHT 8 BEAT 2	
013	013	FUNK 8 BEAT	
014	014	MELLOW 8 BEAT	
015	015	GUITAR 8 BEAT	
016	016	8 BEAT	
017	017	8 BEAT POP	
018	018	OLDIES 8 BEAT	
019	019	60's 8 BEAT	
020	020	16 BEAT	
021	021	16 BEAT SHUFFLE	
DANCE			
022	022	HIP-HOP	
023	023	DANCE POP	
024	024	DISCO POP	
025	025	TECHNO POP	
026	026	TRANCE	
027	027	MODERN R&B	
028	028	MODERN DANCE	
029	029	DISCO SOUL	
ROCK			
030	030	STRAIGHT ROCK	
031	031	SHUFFLE ROCK	
032	032	SHUFFLE BLUES	
033	033	ROCK BLUES	
034	034	EP BLUES	
035	035	SLOW BLUES	
036	036	SOFT ROCK	
037	037	LATIN ROCK	
038	038	SLOW ROCK	
039	039	50's ROCK	
040	040	50's PIANO ROCK	
041	041	NEW ORLNS R&R	
042	042	60's ROCK	
043	043	ROCK	
044	044	70's PIANO ROCK	
045	045	ROCK WALTZ	
<b>JAZZ/EUROPEAN</b>			
JAZZ			
001	046	SLOW BIG BAND	
002	047	MIDDLE BIG BAND	
003	048	FAST BIG BAND	
004	049	ORCHESTRA SWING	
005	050	SWING	
006	051	SLOW SWING	
007	052	JAZZ WALTZ	
008	053	FOX TROT	
009	054	QUICKSTEP	
010	055	JAZZ COMBO 1	
EUROPEAN			
011	056	SCHLAGER	
012	057	POLKA	

Group Name/ Nombre del grupo	Group Number/ Número de grupo	Sequential Number/ Número secuencial	Rhythm name/ Nombre del ritmo
	013	058	WALTZ 1
	014	059	WALTZ 2
	015	060	SLOW WALTZ
	016	061	VIENNESE WALTZ
	017	062	FRENCH WALTZ
	018	063	SERENADE
	019	064	TANGO
	020	065	MARCH 1
	021	066	MARCH 2
<b>LATIN</b>			
LATIN I			
	001	067	BOSSA NOVA
	002	068	SLOW BOSSA NOVA
	003	069	BEGUINE
	004	070	SAMBA 1
	005	071	SAMBA 2
	006	072	MAMBO
	007	073	RHUMBA
	008	074	CHA-CHA-CHA
	009	075	MERENGUE
	010	076	BOLERO
	011	077	SALSA 1
	012	078	SALSA 2
	013	079	REGGAE
	014	080	POP REGGAE
	015	081	SKA
LATIN II			
	016	082	REGGAETON 1
	017	083	REGGAETON 2
	018	084	CUMBIA
	019	085	CALYPSO
	020	086	FORRO
	021	087	PAGODE
	022	088	BANDA
	023	089	PASILLO
	024	090	ARGENTINE CUMBIA
	025	091	PUNTA
	026	092	BACHATA
<b>WORLD</b>			
WORLD I			
AMERICAN			
	001	093	DIXIE
	002	094	TEX-MEX
	003	095	FAST GOSPEL
	004	096	SLOW GOSPEL
	005	097	HAWAIIAN
SPANISH/EASTERN EUROPEAN			
	006	098	PASODOBLE
	007	099	CAUCASIAN
	008	100	RUSSIAN CHANSON 1
	009	101	RUSSIAN CHANSON 2
	010	102	POLISH WALTZ
ARABIC/ORIENTAL			
	011	103	SIRTAKI
	012	104	MUS
	013	105	ADANI
	014	106	BALADI
	015	107	KHALIJI
	016	108	MALFOUF
WORLD II			
INDIAN			
	017	109	BHANGRA
	018	110	DADRA
	019	111	GARBA
	020	112	KEHARWA

Group Name/ Nombre del grupo	Group Number/ Número de grupo	Sequential Number/ Número secuencial	Rhythm name/ Nombre del ritmo
	021	113	DANDIYA
	022	114	TEEN TAAL
	023	115	BHAJAN
CHINESE			
	024	116	GUANGDONG
	025	117	JIANGNAN
	026	118	BEIJING
	027	119	DONGBEIYANGGE
	028	120	JINGJU
	029	121	HUANGMEIXI
	030	122	QINQIANG
	031	123	YUJU
	032	124	YAOZU
	033	125	DAIZU
	034	126	MIAOZU
	035	127	MENGGU
	036	128	XINJIANG
	037	129	ZANGZU
SOUTHEAST ASIAN			
	038	130	KRONCONG
	039	131	DANGDUT
JAPANESE			
	040	132	ENKA
COUNTRY/VARIOUS			
COUNTRY			
	001	133	MODERN COUNTRY
	002	134	COUNTRY 8 BEAT
	003	135	COUNTRY BALLAD
	004	136	COUNTRY SHUFFLE
	005	137	FINGER PICKING COUNTRY
	006	138	COUNTRY WALTZ
	007	139	BLUEGRASS
VARIOUS			
	008	140	CHRISTMAS SONG
	009	141	CHRISTMAS WALTZ
	010	142	SCREEN SWING
	011	143	SYMPHONY
	012	144	STR QUARTET
BALLAD			
BALLAD			
	001	145	PIANO ROCK BALLAD
	002	146	90's BALLAD
	003	147	MODERN BALLAD
	004	148	ELECTRIC BALLAD
	005	149	SLOW BALLAD 1
	006	150	SLOW BALLAD 2
	007	151	R&B BALLAD
	008	152	16 BEAT BALLAD
	009	153	SOUL BALLAD
	010	154	POP BALLAD 1
	011	155	POP BALLAD 2
	012	156	PIANO WALTZ BALLAD
	013	157	90's 6/8 BALLAD
	014	158	6/8 BALLAD 1
	015	159	6/8 BALLAD 2
	016	160	ROCK BALLAD
PIANO RHYTHMS			
PIANO RHYTHMS			
	001	161	PIANO 8 BEAT
	002	162	PIANO BALLAD 1
	003	163	PIANO BALLAD 2
	004	164	EP BALLAD 1
	005	165	EP BALLAD 2
	006	166	BLUES BALLAD
	007	167	JAZZ COMBO 2
	008	168	JAZZ COMBO 3
	009	169	RAGTIME
	010	170	BOOGIE-WOOGIE

Group Name/ Nombre del grupo	Group Number/ Número de grupo	Sequential Number/ Número secuencial	Rhythm name/ Nombre del ritmo
	011	171	PIANO ROCK & ROLL
	012	172	ARPEGGIO 1
	013	173	ARPEGGIO 2
	014	174	ARPEGGIO 3
	015	175	PIANO MARCH 1
	016	176	PIANO MARCH 2
	017	177	STRIDE PIANO
	018	178	WALTZ 3
	019	179	WALTZ 4
	020	180	WALTZ 5

 NOTE

- Sequential number rhythms 171 through 180 do not sound unless a chord is being played.

 NOTA

- Los ritmos secuenciales números 171 al 180 no suenan a menos que se ejecute un acorde.

## Music Preset List/Lista de preajustes musicales

Group Name/ Nombre del grupo	Group Number/ Número de grupo	Sequential Number/ Número secuencial	Preset Name/ Nombre de preajuste
<b>1</b>			
POPS			
1	1	1	Soft Pop
2	2	2	Winter Pop
3	3	3	Oldies Pop
4	4	4	Alpine Flora
5	5	5	Gypsy
6	6	6	Rain Pop
7	7	7	Movie Waltz
8	8	8	Funky Pop
9	9	9	Love Pop
10	10	10	60's Pop
11	11	11	Rising Sun
12	12	12	Pop Ska
13	13	13	Weep Blues
14	14	14	Cartoon
15	15	15	Carol
16	16	16	My Life
17	17	17	Blue Love
18	18	18	Xmas Pop
19	19	19	Shuffle Pop1
20	20	20	Shuffle Pop2
21	21	21	70's Soul
22	22	22	70's Pop
23	23	23	West Coast
24	24	24	Bossa Pop
25	25	25	Radio Pop
26	26	26	Crazy Roll
27	27	27	80's Pop 1
28	28	28	80's Pop 2
29	29	29	UK Pop 1
30	30	30	UK Pop 2
31	31	31	A Feeling
32	32	32	Calling
33	33	33	80's EuroPop
34	34	34	The World
35	35	35	Mexican Pop
36	36	36	Guitar Pop
37	37	37	90's Pop
38	38	38	Wonder
39	39	39	Modern Pop 1
40	40	40	Modern Pop 2
41	41	41	MdrnPopRock
DANCE			
42	42	42	Funky Disco
43	43	43	Funky Clavi
44	44	44	Disco Soul
45	45	45	70's Disco
46	46	46	Disco Lady
47	47	47	Staying
48	48	48	Up&Down
49	49	49	80's Disco
50	50	50	80'sDancePop
51	51	51	Bb Girl
52	52	52	Blv Disco
53	53	53	Lady Jam
54	54	54	Into Your H
55	55	55	Euro Pop
56	56	56	Modern Dance
57	57	57	Trance
58	58	58	ShuffleDance
ROCK			
59	59	59	50's Rock 1
60	60	60	50's Rock 2
61	61	61	Heartache
62	62	62	EP R&R
63	63	63	Pop R&B
64	64	64	60's Rock 1
65	65	65	60's Rock 2
66	66	66	60's Rock 3
67	67	67	60's Rock 4
68	68	68	60's Rock 5
69	69	69	Get Rock
70	70	70	Honky Rock
71	71	71	Wild Rock
72	72	72	Alligator
73	73	73	Movie Rock
74	74	74	Pop Rock

Group Name/ Nombre del grupo	Group Number/ Número de grupo	Sequential Number/ Número secuencial	Preset Name/ Nombre de preajuste
	75	75	16Bt Shuffle
	76	76	Heat Up
	77	77	Hard Rock
	78	78	Grunge Rock
	79	79	Modern Rock
	80	80	R&R
	81	81	Piano R&R
	82	82	Blues
	83	83	8 Bars Blues
	84	84	Riff Rock 1
	85	85	Riff Rock 2
	86	86	Riff Rock 3
<b>2</b>			
CLASSIC			
	1	87	Canon
	2	88	Air G String
	3	89	Je Te Veux
	4	90	Adagio
	5	91	Spring
	6	92	Ave Maria
	7	93	JesusBleibet
	8	94	Symphony 25
	9	95	Symphony 40
	10	96	HungriaDance
	11	97	Eine Kleine
	12	98	Pathetique
	13	99	Moonlight
	14	100	PstlSymphony
	15	101	Ode To Joy
	16	102	Le Cygne
	17	103	Swan Lake
	18	104	Valse Fleurs
	19	105	Habanera
	20	106	Nocturne
	21	107	Etude
	22	108	FrenchCancan
	23	109	Fantaisielmp
	24	110	Humoresque
	25	111	Pavane
	26	112	Hope & Glory
	27	113	Moldau
	28	114	FromNewWorld
	29	115	Reverie
	30	116	Nutcracker
	31	117	Liebesträume
	32	118	Gymnopedies
	33	119	Jupiter
	34	120	Entertainer
	35	121	MapleLeafRag
TRAD			
	36	122	Michael Row
	37	123	GrndpasClock
	38	124	Troika
	39	125	AuldLangSyne
	40	126	Aloha Oe
	41	127	O Sole Mio
	42	128	Furusato
	43	129	SzlaDziweczka
	44	130	Battle Hymn
	45	131	Condor
	46	132	ScarboroFair
	47	133	Danny Boy
	48	134	Greensleeves
	49	135	Annie Laurie
	50	136	AmazingGrace
	51	137	WeWishU Xmas
	52	138	Silent Night
	53	139	Joy To World
	54	140	YankeeDoodle
	55	141	Clarnt Polka
	56	142	TaRaRaBoom
	57	143	Double Eagle
	58	144	Blauen Donau
	59	145	Yellow Rose
	60	146	BeautDreamer
LATIN			
	61	147	Satellite
	62	148	Rio



















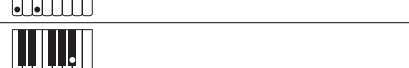

Group Name/ Nombre del grupo	Group Number/ Número de grupo	Sequential Number/ Número secuencial	Preset Name/ Nombre de preajuste
	63	149	Aqua
	64	150	Single
	65	151	Sea Shore
	66	152	Poor Pitch
	67	153	Mountain
	68	154	Heartless
	69	155	Carnival
	70	156	Mythology
	71	157	Tico-Tico
	72	158	Beguine
	73	159	Amapola
	74	160	La Paloma
	75	161	Banana Boat
	76	162	Peanut
	77	163	A Cup Of
	78	164	Jamaica
	79	165	60's Movie 1
	80	166	60's Movie 2
	81	167	The No.5
	82	168	Everyday
	83	169	Kiss Me
	84	170	El Tango
	85	171	El Choclo
	86	172	Reggae 1
	87	173	Reggae 2
	88	174	Pop Reggae 1
	89	175	Pop Reggae 2
	90	176	Latin Rock 1
	91	177	Latin Rock 2
	92	178	Modern Latin
<b>COUNTRY</b>			
	93	179	US Folk 1
	94	180	US Folk 2
	95	181	50's Country
	96	182	70's Country
	97	183	60's Folk
	98	184	Tree
	99	185	A Friend
	100	186	Cowboy
	101	187	Country Bld1
	102	188	Country Bld2
	103	189	Country Bld3
	104	190	CountryWaltz
	105	191	Mdrn Country
<b>3</b>			
<b>BALLAD</b>			
	1	192	Love Ballad
	2	193	R&B Ballad
	3	194	Soul Ballad
	4	195	Blues Ballad
	5	196	MovieBallad1
	6	197	MovieBallad2
	7	198	MovieBallad3
	8	199	Xmas Ballad
	9	200	Love Me
	10	201	Oldies Bld 1
	11	202	Oldies Bld 2
	12	203	Oldies Bld 3
	13	204	Oldies Bld 4
	14	205	E World
	15	206	Guitar Bld 1
	16	207	Guitar Bld 2
	17	208	Moon Waltz
	18	209	Theme
	19	210	Paradise
	20	211	60's Ballad1
	21	212	60's Ballad2
	22	213	Baroque Bld
	23	214	FrenchBallad
	24	215	Everywhere
	25	216	Wonderful
	26	217	70's Ballad1
	27	218	70's Ballad2
	28	219	70's Ballad3
	29	220	My Song
	30	221	Peace
	31	222	Without
	32	223	Soundtrack
	33	224	Soft Ballad
	34	225	Memories
	35	226	Minor Ballad
	36	227	Pop Ballad 1

Group Name/ Nombre del grupo	Group Number/ Número de grupo	Sequential Number/ Número secuencial	Preset Name/ Nombre de preajuste
	37	228	Pop Ballad 2
	38	229	PianoBallad1
	39	230	PianoBallad2
	40	231	Musical Bld
	41	232	R Ballad
	42	233	Love Song
	43	234	80's Ballad1
	44	235	80's Ballad2
	45	236	80's Ballad3
	46	237	80's Ballad4
	47	238	Friends
	48	239	Rock Ballad1
	49	240	Rock Ballad2
	50	241	Two Flames
	51	242	90's Ballad1
	52	243	90's Ballad2
	53	244	90's Ballad3
	54	245	90's SoulBld
	55	246	I Always
	56	247	6/8 Ballad
	57	248	Wind Ballad
	58	249	90's 6/8 Bld
	59	250	My Ballad
	60	251	MdrnSoulBld1
	61	252	MdrnSoulBld2
	62	253	Mdrn Pf Bld
	63	254	Rap Ballad
	64	255	Dance Ballad
	65	256	MdrnRock Bld
	66	257	Slow Ballad
	67	258	90's R&B Bld
<b>JAZZ</b>			
	68	259	My Swing
	69	260	Your Things
	70	261	Angel
	71	262	Time Passes
	72	263	Piano Trio
	73	264	Goodbye
	74	265	Marine Dance
	75	266	Vine Days
	76	267	TraneChanges
	77	268	RhythmChange
	78	269	Swing Mood
	79	270	The Big Mood
	80	271	Brown Jug
	81	272	Jazz Club
	82	273	All Day Long
	83	274	Avenue
	84	275	Big Band 1
	85	276	Big Band 2
	86	277	Jazz Waltz 1
	87	278	Jazz Waltz 2
	88	279	Jazz Waltz 3
	89	280	Mode Jazz
	90	281	Tea Time
	91	282	Welcome Home
	92	283	Jazz Opera
	93	284	NY City
	94	285	Soul & Jazz
	95	286	Loneliness
	96	287	Foggy
	97	288	Moon Swing
	98	289	Jazz Ballad1
	99	290	Jazz Ballad2
	100	291	Jazz Ballad3
	101	292	PatheticTrip
	102	293	Night Sky
	103	294	Twilight
	104	295	Blues in F
	105	296	Blues in Bb
	106	297	Blues in C
	107	298	II-V
	108	299	II-V-I
	109	300	Minor Blues

## Fingering Guide/ Guía de digitación

### Fingered 1, Fingered 2 Chords/ Acordes Fingered 1, Fingered 2

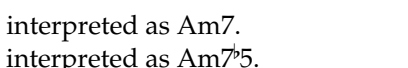
<b>C</b>	
<b>Cm</b>	
<b>Cdim</b>	
<b>Caug</b> *3	
<b>Csus4</b> *3	
<b>Csus2</b> *3	
<b>C7</b>	
<b>Cm7</b> *3	
<b>CM7</b>	
<b>Cm7<sup>b</sup>5</b> *3	
<b>C7<sup>b</sup>5</b> *3	
<b>C7sus4</b>	
<b>Cadd9</b>	
<b>Cmadd9</b>	
<b>CmM7</b>	
<b>Cdim7</b> *3	
<b>C69</b> *3	
<b>C6</b> *1 *3	
<b>Cm6</b> *2 *3	

\*1 With Fingered 2, interpreted as Am7.

\*2 With Fingered 2, interpreted as Am7<sup>b</sup>5.

\*3 Inverted form not supported in some cases.

\*1 Con Fingered 2, se interpreta como Am7.

\*2 Con Fingered 2, se interpreta como Am7<sup>b</sup>5.

\*3 En algunos casos no se puede usar de forma invertida.

### Fingered 3, Full Range Chords/ Acordes Fingered 3, Full Range

In addition to the chords that can be fingered with Fingered 1 and Fingered 2, the following chords also are recognized.

Además de los acordes que se pueden digitar con Fingered 1 y Fingered 2, también se pueden reconocer los siguientes acordes.

$\frac{C^\#}{C}$	$\frac{D}{C}$	$\frac{E}{C}$	$\frac{F}{C}$	$\frac{G}{C}$	$\frac{A^b}{C}$	$\frac{B^b}{C}$	$\frac{B}{C}$	$\frac{C^\#m}{C}$	$\frac{Dm}{C}$	$\frac{Fm}{C}$
$\frac{Gm}{C}$	$\frac{Am}{C}$	$\frac{B^bm}{C}$	$\frac{Ddim}{C}$	$\frac{A^b7}{C}$	$\frac{F7}{C}$	$\frac{Fm7}{C}$	$\frac{Gm7}{C}$	$\frac{A^badd9}{C}$		

#### NOTE

- With Fingered 3, the lowest note fingered is interpreted as the base note. Inverted forms are not supported.
- With Full Range Chord, when the lowest fingered is a certain distance from the neighboring note, the chord is interpreted as a fraction chord.
- Unlike Fingered 1, 2, and 3, Full Range Chord requires pressing of at least three keys to form a chord.

#### NOTA

- Con Fingered 3, la nota más baja digitada se interpreta como nota base. No se pueden usar formas invertidas.
- Con Full Range Chord, cuando la nota digitada más baja se encuentre a cierta distancia de la nota adyacente, el acorde se interpreta como un acorde bitonal.
- A diferencia de Fingered 1, 2, y 3, Full Range Chord requiere la pulsación de tres teclas como mínimo para formar un acorde.

# Chord Example List/Lista de ejemplos de acordes

Root Chord Type	C	C#(D-)	D	(D#)/E+	E	F	F#(G-)	G	(G#)/A+	A	(A#)/B+	B
M												
m												
dim												
aug												
sus4												
sus2												
7												
m7												
M7												
m7 <sup>b5</sup>												
7 <sup>b5</sup>												
7sus4												
add9												
madd9												
mM7												
dim7												
69												
6												
m6												

- Since the chord input range is limited, this model may not support some of the chords shown above.
- Debido a que el rango de entrada de acordes es limitado, es posible que este modelo no admita algunos de los acordes mostrados arriba.

- Cut this page along the dashed line so you can have it on hand as you read the contents of the manual.
- Recorte esta página por la línea de puntos para tenerla a mano mientras continúa leyendo este manual.

# PX-350M

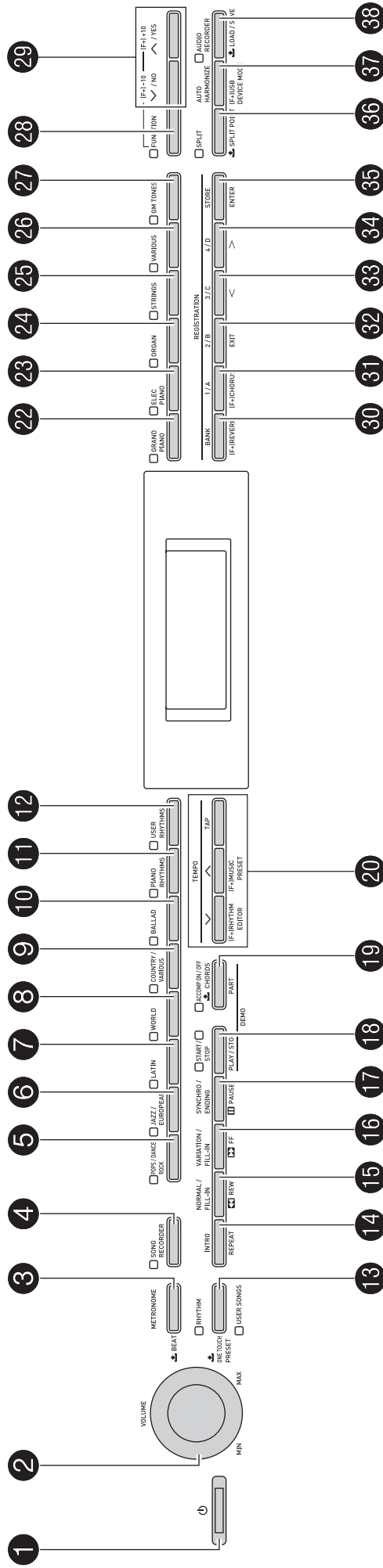

# MIDI Implementation Chart

Function	Transmitted	Recognized	Remarks
<b>Basic Channel</b> Default Changed	1 - 16 1 - 16	1 - 16 1 - 16	
<b>Mode</b> Default Messages Altered	Mode 3 X * * * * * * * * * *	Mode 3 X * * * * * * * * * *	
<b>Note Number</b> True voice	0 - 127 * * * * * * * * * *	0 - 127 0 - 127*1	
<b>Velocity</b> Note ON Note OFF	0 9nH v = 1 - 127 X 8nH v = 64	0 9nH v = 1 - 127 X 9nH v = 0, 8nH v = **	** : no relation ** : sin relación
<b>After Touch</b> Key's Ch's	X X	X O	
<b>Pitch Bender</b>	O	O	
<b>Control Change</b>	0,32 1 5 6,38 7 10 11 16 17 18 19 64 65 66	O X X O O X X X X X X X X X O X O	Bank select Modulation Portamento Time Data entry LSB, MSB*2 Volume Pan Expression DSP Parameter0*2 DSP Parameter1*2 DSP Parameter2*2 DSP Parameter3*2 Damper Portamento Switch Sostenuto

67 76 77 78 80 81 82 83 84 88 91 93 100, 101	<input type="checkbox"/> X <input type="checkbox"/> X <input type="checkbox"/> X <input type="checkbox"/> X <input type="checkbox"/> X <input type="checkbox"/> X <input type="checkbox"/> X <input type="checkbox"/> X <input type="checkbox"/> X <input type="checkbox"/> O <input type="checkbox"/> O <input type="checkbox"/> O	<input type="checkbox"/> O <input type="checkbox"/> O <input type="checkbox"/> O <input type="checkbox"/> O <input type="checkbox"/> O <input type="checkbox"/> O <input type="checkbox"/> O <input type="checkbox"/> O <input type="checkbox"/> O <input type="checkbox"/> O <input type="checkbox"/> O <input type="checkbox"/> O	Soft pedal Vibrato rate Vibrato depth Vibrato delay DSP Parameter4*2 DSP Parameter5*2 DSP Parameter6*2 DSP Parameter7*2 Portamento Control High resolution velocity prefix*3 Reverb send Chorus send RPN LSB, MSB*2
<b>Program Change</b> : True #	<input type="checkbox"/> O	<input type="checkbox"/> O	0 - 127
<b>System Exclusive</b>	<input type="checkbox"/> O	<input type="checkbox"/> O	*2
<b>System Common</b> : Song Pos : Song Sel : Tune	<input checked="" type="checkbox"/> X <input checked="" type="checkbox"/> X <input checked="" type="checkbox"/> X	<input checked="" type="checkbox"/> X <input checked="" type="checkbox"/> X <input checked="" type="checkbox"/> X	
<b>System Real Time</b> : Clock : Commands	<input type="checkbox"/> O <input type="checkbox"/> O	<input checked="" type="checkbox"/> X <input checked="" type="checkbox"/> X	
<b>Aux Messages</b> : All sound off : Reset all controller : Local ON/OFF : All notes OFF : Active Sense : Reset	<input type="checkbox"/> O <input type="checkbox"/> O <input checked="" type="checkbox"/> X <input type="checkbox"/> O <input checked="" type="checkbox"/> X <input checked="" type="checkbox"/> X	<input type="checkbox"/> O <input type="checkbox"/> O <input checked="" type="checkbox"/> X <input type="checkbox"/> O <input type="checkbox"/> O <input checked="" type="checkbox"/> X	
<b>Remarks</b>	*1 : Depends on tone *2 : For details, see MIDI Implementation at <a href="http://world.casio.com/">http://world.casio.com/</a> . *3 : Note on only *1 : Depende del tono *2 : Si desea más información, vea Implementación MIDI en <a href="http://world.casio.com/">http://world.casio.com/</a> . *3 : Nota activada solamente		

Mode 1 : OMNI ON, POLY  
Mode 3 : OMNI OFF, POLY

Mode 2 : OMNI ON, MONO  
Mode 4 : OMNI OFF, MONO

O : Yes  
X : No



This recycle mark indicates that the packaging conforms to the environmental protection legislation in Germany.

Esta marca de reciclaje indica que el empaquetado se ajusta a la legislación de protección ambiental en Alemania.

**CASIO®**

