

Handy Audio Interface **U-22**

Operation Manual

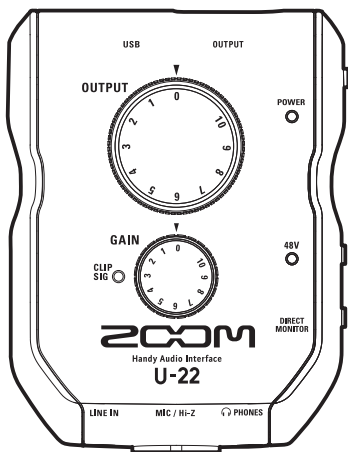

Contents

Introduction	2	Recording	10
Safety and Usage Precautions	2	Playback	12
Part Names	4	Troubleshooting	14
Connecting with a Computer/iPad	6	Specifications	15

Introduction

Thank you for choosing the ZOOM **U-22** Handy Audio Interface.

To achieve the best results—and to protect your investment—please read this manual carefully and retain it for future reference.

Use this product only as directed.

2-in/2-out Mobile Audio Interface

The **U-22** is a high-quality mobile audio interface that supports recording and playback at resolutions up to 24-bit/96 kHz.

Since the **U-22** can run on batteries as well as bus power, you can make music with it anywhere.

The **U-22** is compatible with Mac, PC and iPad.

Attention to Audio Performance

Featuring an asynchronous transfer system, the **U-22** is not impacted by computer jitter, and reproduces audio with complete accuracy.

High-Performance Mic Preamp

The **U-22** is equipped with a high-performance mic preamp based on those found in our acclaimed H-Series recorders.

The input features +48V phantom power, and a designated MIC/Hi-Z jack supports high impedance input.

Safety and Usage Precautions

Safety Precautions

In this operation manual, symbols are used to highlight warnings and cautions that you must read to prevent accidents. The meanings of these symbols are as follows.



Warning

Something that could cause serious injury or death



Caution

Something that could cause injury or damage to the equipment

Other symbols used



An action that is mandatory



An action that is prohibited

Warning

Alterations

- ⊘ Do not open the case or modify the product.

Operation using an AC adapter

- ⚠ Never use any AC adapter other than a ZOOM AD-17.
- ⚠ Always hold the AC adapter itself when disconnecting it from an outlet.

Operation with external DC power supply

- ⚠ Use a 5V external DC power supply.
- ⚠ Carefully study the warning indications of the external DC power supply before use.

Operation using batteries

- ⚠ Use 2 ordinary 1.5-volt AA batteries (alkaline or nickel-metal hydride).
- ⚠ Read battery warning labels carefully.
- ⚠ Always close the battery compartment cover when using the unit.

Safety and Usage Precautions (continued)

Caution

Product handling

- ❗ Do not drop, bump or apply excessive force to the unit.
- ❗ Be careful not to allow foreign objects or liquids to enter the unit.

Battery handling

- ❗ Install the batteries with the correct +/- orientation.
- ❗ Use a specified battery type.
Do not mix new and old batteries or different brands or types at the same time.
- ❗ When not using the unit for an extended period of time, remove the batteries.

If a battery leak should occur, wipe the battery compartment and the battery terminals carefully to remove all residue.

Operating environment

- ⊘ Do not use in extremely high or low temperatures.
- ⊘ Do not use near heaters, stoves and other heat sources.
- ⊘ Do not use in very high humidity or where it could be splashed by water.
- ⊘ Do not use in places with frequent vibrations.
- ⊘ Do not use in places with much dust or sand.

Connection cables and input/output jacks

- ❗ Always turn the power OFF for all equipment before connecting any cables.
- ❗ Always disconnect all connection cables and the AC adapter before moving the unit.

Volume

- ⊘ Do not use at a loud volume for a long time.

Usage Precautions

Interference with other electrical equipment

For safety considerations, **U-22** is designed to minimize the emission of electromagnetic waves and suppress interference from external electromagnetic waves. However, interference could still occur if **U-22** is placed next to equipment that is very susceptible to interference or that emits powerful electromagnetic waves. If this occurs, place the **U-22** and the other device farther apart.

With any type of digital control device—including the **U-22**—electromagnetic interference can cause malfunction, corrupt or destroy data, or cause other unexpected issues. Always exercise caution.

Cleaning

Use a soft cloth to clean the exterior of the unit if it becomes dirty.
If necessary, use a damp cloth that has been wrung out well to wipe it.
Never use abrasive cleansers, wax or solvents such as alcohol, benzene or paint thinner.

Temperature considerations

The **U-22** may become warm after long periods of continuous use. This is normal, as long as the unit does not become too hot to touch.

Breakdown and malfunction

If the **U-22** malfunctions or operates abnormally, disconnect it immediately. Contact the store where you purchased the unit, or contact ZOOM customer service with the following information: product model, serial number, and the specific symptoms of the breakdown or malfunction—along with your name, address, and telephone number.

Copyrights

- Windows® is a registered trademark of Microsoft® Corporation.
- Mac®, iPad® and Lightning™ are trademarks or registered trademarks of Apple Inc.
- MIDI is a registered trademark of Association of Musical Electronics Industry (AMEI).
- Other product names, registered trademarks and company names in this document are the property of their respective companies.

Note: All trademarks and registered trademarks in this document are for identification purposes only and are not intended to infringe on the copyrights of their respective owners.

Recording for any purpose other than personal use from copyrighted sources, including CDs, records, tapes, live performances, video works and broadcasts, without permission of the copyright holder is prohibited by law. ZOOM Corporation will not assume any responsibility related to infringements of copyrights.

FCC regulation warning (for U.S.A.)

This equipment has been tested and found to comply with the limits for a Class B digital device, pursuant to Part 15 of the FCC Rules. These limits are designed to provide reasonable protection against harmful interference in a residential installation. This equipment generates, uses, and can radiate radio frequency energy and, if not installed and used in accordance with the instructions, may cause harmful interference to radio or television reception, which can be determined by turning the equipment off and on, the user is encouraged to try to correct the interference by one or more of the following measures:

- Reorient or relocate the receiving antenna.
- Increase the separation between the equipment and receiver.
- Connect the equipment to an outlet on a circuit different from that to which the receiver is connected.
- Consult the dealer or an experienced radio/TV technician for help.

For EU Countries



Declaration of Conformity

Part Names

■ Top

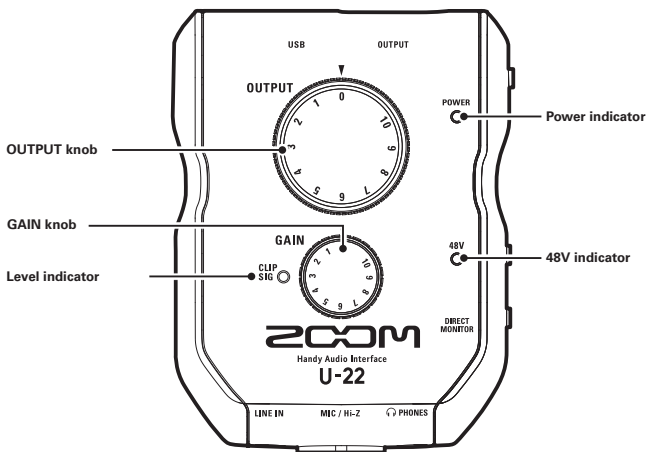

■ Back

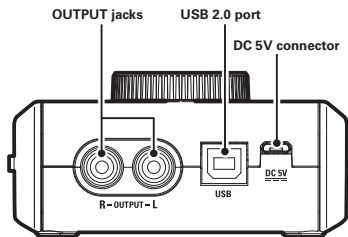

■ Right side

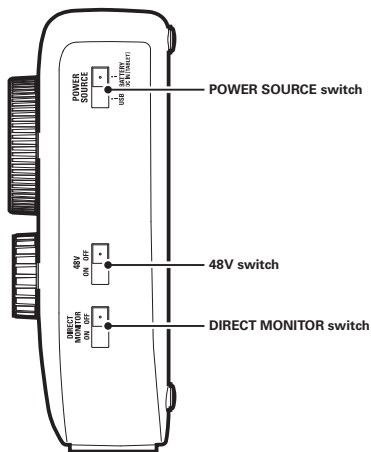

■ Front

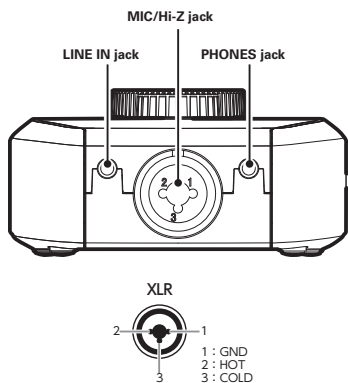

Installing the Driver

Do not connect the **U-22** until installation completes.

■ Windows

1. Download the ZOOM U-22 Driver from <http://www.zoom.co.jp/> to your computer.

NOTE

- You can download the latest ZOOM U-22 driver from the above website.
- Download the appropriate driver for your operating system.

-
2. Launch the installer and install the driver.

Follow the on-screen instructions to install the ZOOM U-22 driver.

NOTE

- See the Installation Guide included in the driver package for detailed installation procedures.

■ Mac

Driver installation is not necessary when using a Mac.

Choosing a Power Source

■ Using bus power

Use a USB cable to connect the **U-22** to the computer.

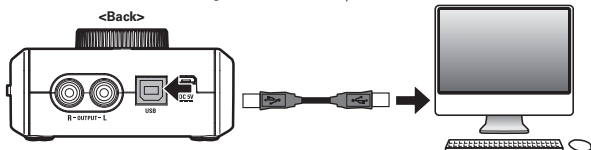

■ Using batteries

1. Open the battery cover on the underside of the **U-22**.

2. Install the batteries.

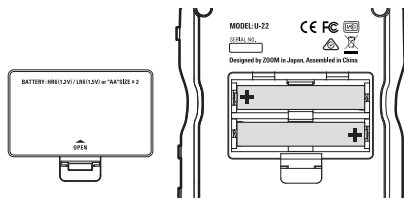

3. Replace the battery cover.

NOTE

- Use only alkaline batteries or rechargeable NiMH batteries.
- The power indicator will blink when the battery charge becomes low. Turn the power off immediately and install new batteries.

■ Using an external power supply

Connect either the optional AD-17 adapter, a commercially available USB power adapter, or a mobile USB battery to the DC 5V connector.

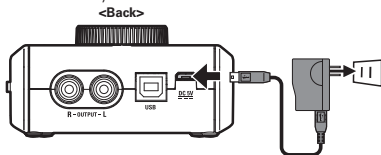

Connecting with a Computer

1. Minimize the volume of any output devices connected to the **U-22**.
2. Use a USB cable to connect the **U-22** to the computer.

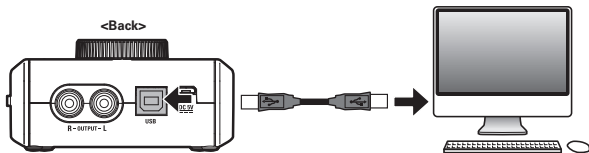

3. Set  to USB or BATTERY/DC IN [TABLET] to turn the power on.

NOTE

- When using batteries or an external power supply, set  to BATTERY/DC IN [TABLET].

4. Confirm that the power indicator is lit.

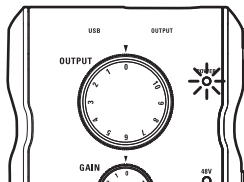

iPad Connection

You can connect the **U-22** to an iPad when using either the optional AD-17 power adapter, an external DC power supply, or AA batteries.

1. Minimize the volume of any output devices connected to the **U-22**.
2. Install batteries or connect an external power supply. (→ P. 7)
3. Connect the **U-22** to the iPad using an Apple iPad Camera Connection Kit or Lightning to USB Camera Adapter.

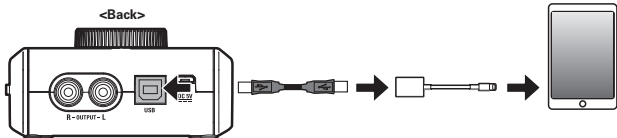

4. Set **POWER SOURCE** to BATTERY/DC IN [TABLET].



After the **U-22** turns on, it will connect to the iPad.

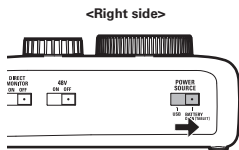

NOTE

- **U-22** cannot accept bus power from an iPad.

5. Confirm that the power indicator is lit.

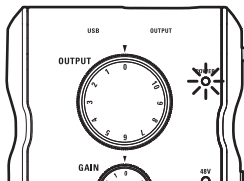

Connecting Instruments and Mics

Use a mono instrument/XLR cable to connect an instrument or mic to the MIC/Hi-Z jack.

Use a stereo mini cable to connect an iPad or other device to the LINE IN jack.

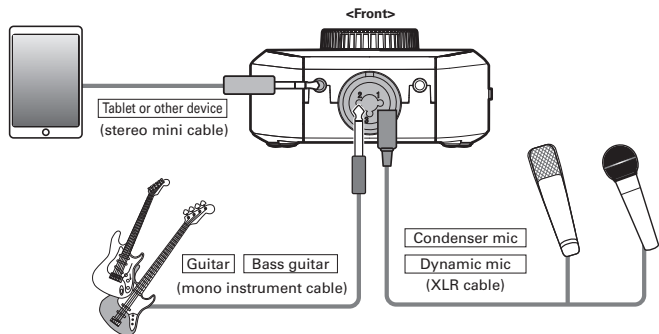

NOTE

- The MIC/Hi-Z jack is disabled when a cable is connected to the LINE IN jack.
- The Hi-Z function will turn ON automatically when a mono instrument cable is connected.

■ Using Phantom Power

Supply phantom power when using a condenser mic.

1. Connect a condenser mic.
-
2. Set  to ON.
-
3. Confirm that the 48V indicator is lit.

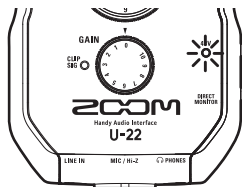

Connecting Instruments and Mics (continued)

■ Adjusting Input Gain

You can adjust the MIC/Hi-Z jack gain.

1. Use the level indicator to check the input signal status.

Green light: Input signal is present.

Red light: Input signal is clipping.

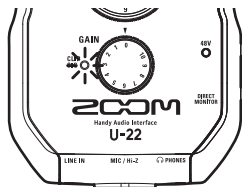

2. Adjust the input gain.

Turn the 

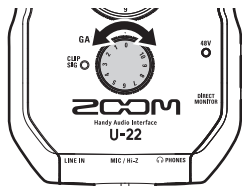

HINT

- To avoid distorted recordings, adjust the input gain so the level indicator doesn't light up red.

NOTE

- The gain is fixed for the LINE IN jack.

Connecting Headphones and Speakers

Connect headphones to the PHONES jack, speakers to the OUTPUT jacks, and adjust the volume levels accordingly.

1. Connect headphones or speakers.

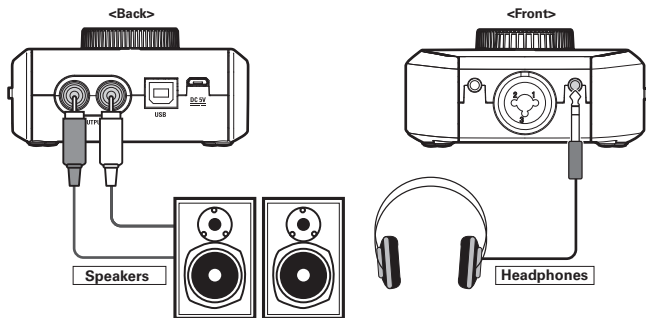

2. Adjust the headphones/speakers volume.

Turn the 

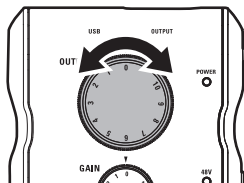

Using Direct Monitoring

Direct monitoring enables you to listen to input signals before they pass through the computer.

This allows you to hear the sound coming into the **U-22** without latency.

1. Set  to ON.

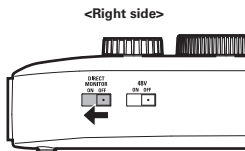

Troubleshooting

Cannot select or use the U-22 device

- Confirm that the **U-22** is connected to the computer correctly.
- Quit all the software that is using the **U-22**, then disconnect and reconnect the USB cable connected to **U-22**.
- Reinstall the driver.
- Connect the **U-22** directly to a USB port on the computer. Do not connect it to a USB hub.

Playback sound cannot be heard or is quiet

- Check the headphone or speaker connections.
- If no sound can be heard or the volume is low from the PHONES or OUTPUT connectors, adjust the OUTPUT knob.
- Confirm that the Sound setting of the computer that you are using is set to "ZOOM U-22".

Recorded audio is too loud, too quiet or silent

- Adjust the input gain of the **U-22**.
- When using a condenser mic, set the 48V switch to ON.
- Confirm that the Sound setting of the computer that you are using is set to "ZOOM U-22".

The sound of the device connected to the input jack is distorted

- Confirm that the level indicator is not lighting red. If it is, lower the input level.
- If the sound of the device connected to the LINE IN jack distorts, reduce the output volume of that device.

Sound skips during playback or recording

- If you can adjust the audio buffer size of the software that you are using, increase the buffer size.
- Turn the automatic sleep function and other computer power saving settings OFF.
- Connect the **U-22** directly to a USB port on the computer. Do not connect it to a USB hub.

Cannot play or record

- Confirm that the Sound setting of the computer that you are using is set to "ZOOM U-22".
- Confirm that **U-22** is set for input and output in the software you are using.
- Confirm that **U-22** is connected to the computer correctly.
- Quit all the software that is using the **U-22**, then disconnect and reconnect the USB cable connected to **U-22**.

Cannot use with an iPad

- Confirm that the batteries are loaded or the external power supply is connected correctly. (→ P. 7)
- Set the POWER SOURCE switch to BATTERY/DC IN [TABLET] to turn the power on.

Specifications

ANALOG IN	MIC/Hi-Z	Specifications	TRS/XLR combo jacks (XLR: 2 hot, TRS: TIP hot)	
		Input gain	0 – 43 dB	
		Input impedance	2.6 k Ω (MIC) 484 k Ω (Hi-Z)	
		Maximum input level	-0.8 dBu (MIC) / +8.7 dBu (Hi-Z)	
		Phantom power	+48 V	
		LINE IN	Connector	Stereo mini jack
		Input impedance	22 k Ω	
		Maximum input level	+1.0 dBu	
ANALOG OUT	OUTPUT L/R	Connector	RCA (coaxial)	
		Maximum output level	-0.8 dBu (@0 dBFS) (into 10 k Ω load)	
		Output impedance	1 k Ω	
		PNONES	Connector	Stereo mini jack 10 mW x 2 (into 32 Ω load)
			Output impedance	10 Ω
Frequency characteristics		44.1 kHz: \pm 1.5 dB (20 Hz - 20 kHz) 96 kHz: \pm 2 dB (20 Hz - 40 kHz)		
Input conversion noise		Measured EIN: -120 dB or less (IHF-A) (with 43 dB, 150 Ω input)		
Number of audio recording and playback channels		Recording: 2 channels Playback: 2 channels		
Sampling frequencies		96 kHz, 88.2 kHz, 48 kHz, 44.1 kHz		
Bit depth		24-bit		
Interface		USB2.0		
Power Source		USB bus power (Type B) DC 5 V power supply (Micro-B) 2 AA batteries (about 5 hours continuous operation with phantom power off)		
Power consumption		5 W maximum		
Dimensions		119.2 mm (D) x 91.8 mm (W) x 44.6 mm (H)		
Weight (main unit only)		151 g		

* 0 dBu = 0.775 V_{rms}

Note: The continuous operation time with batteries is just an estimate. This result is from in-house testing methods. The actual time will vary greatly according to operating conditions.



ZOOM CORPORATION

4-4-3 Kandasurugadai, Chiyoda-ku, Tokyo 101-0062 Japan

<http://www.zoom.co.jp>