

# KC-150

## 4-CH MIXING KEYBOARD AMPLIFIER

# Owner's Manual

Thank you, and congratulations on your choice of the Roland Keyboard Amplifier KC-150.

These sections provide important information concerning the proper operation of the unit. Additionally, in order to feel assured that you have gained a good grasp of every feature provided by your new unit, Owner's manual should be read in its entirety. The manual should be saved and kept on hand as a convenient reference.

**Before using this unit, carefully read the sections entitled**

- **IMPORTANT SAFETY INSTRUCTIONS (p. 2)**
- **USING THE UNIT SAFELY (p. 3–p. 4)**
- **IMPORTANT NOTES (p. 5).**
- **Using a Speaker Stand (p. 10)**

This unit is equipped with a protection circuit.

The protection circuit helps ensure safety by operating when excessive input continues for a long time while the device is at a location with a high ambient temperature. Sound drop-out may occur when the protection circuit is actuated during use.

Please read through the documentation carefully to ensure correct use.

## Features



---

- This monitor-speaker amplifier is designed to provide high-quality sound for a variety of sources, including digital keyboards and sound modules.
- The two-way monitor features a 30-cm (12-inch) speaker and tweeter, and delivers a full 65 watts of high-power output.
- The input section features a four-channel mixer. Channel 1 is provided with an XLR connector in addition to supporting mic input. Channel 4 features a convenient monitor function that can be used for stage monitoring.
- Features a SUBWOOFER OUT jack, allowing connection of a subwoofer for playback of even more impressive bass.
- Provided with an RCA phono type AUX IN jack, making it easy to connect devices such as CD and MD players.
- Master section includes a handy two-band equalizer for adjusting sound quality.
- Provided with a convenient headphones jack for use of the monitor at night.

Copyright © 2003 ROLAND CORPORATION

All rights reserved. No part of this publication may be reproduced in any form without the written permission of ROLAND CORPORATION.

**WARNING:** To reduce the risk of fire or electric shock, do not expose this apparatus to rain or moisture.

  
<b>ATTENTION:</b> RISQUE DE CHOC ELECTRIQUE NE PAS OUVRIR
<b>CAUTION:</b> TO REDUCE THE RISK OF ELECTRIC SHOCK, DO NOT REMOVE COVER (OR BACK). NO USER-SERVICEABLE PARTS INSIDE. REFER SERVICING TO QUALIFIED SERVICE PERSONNEL.



The lightning flash with arrowhead symbol, within an equilateral triangle, is intended to alert the user to the presence of uninsulated "dangerous voltage" within the product's enclosure that may be of sufficient magnitude to constitute a risk of electric shock to persons.



The exclamation point within an equilateral triangle is intended to alert the user to the presence of important operating and maintenance (servicing) instructions in the literature accompanying the product.

INSTRUCTIONS PERTAINING TO A RISK OF FIRE, ELECTRIC SHOCK, OR INJURY TO PERSONS.

## IMPORTANT SAFETY INSTRUCTIONS SAVE THESE INSTRUCTIONS

**WARNING** - When using electric products, basic precautions should always be followed, including the following:

1. Read these instructions.
2. Keep these instructions.
3. Heed all warnings.
4. Follow all instructions.
5. Do not use this apparatus near water.
6. Clean only with a dry cloth.
7. Do not block any of the ventilation openings. Install in accordance with the manufacturers instructions.
8. Do not install near any heat sources such as radiators, heat registers, stoves, or other apparatus (including amplifiers) that produce heat.
9. Do not defeat the safety purpose of the polarized or grounding-type plug. A polarized plug has two blades with one wider than the other. A grounding type plug has two blades and a third grounding prong. The wide blade or the third prong are provided for your safety. If the provided plug does not fit into your outlet, consult an electrician for replacement of the obsolete outlet.
10. Protect the power cord from being walked on or pinched particularly at plugs, convenience receptacles, and the point where they exit from the apparatus.
11. Only use attachments/accessories specified by the manufacturer.
12. Unplug this apparatus during lightning storms or when unused for long periods of time.
13. Refer all servicing to qualified service personnel. Servicing is required when the apparatus has been damaged in any way, such as power-supply cord or plug is damaged, liquid has been spilled or objects have fallen into the apparatus, the apparatus has been exposed to rain or moisture, does not operate normally, or has been dropped.

For the U.K.

**WARNING:** THIS APPARATUS MUST BE EARTHED

**IMPORTANT:** THE WIRES IN THIS MAINS LEAD ARE COLOURED IN ACCORDANCE WITH THE FOLLOWING CODE.  
GREEN-AND-YELLOW: EARTH, BLUE: NEUTRAL, BROWN: LIVE

As the colours of the wires in the mains lead of this apparatus may not correspond with the coloured markings identifying the terminals in your plug, proceed as follows:

The wire which is coloured GREEN-AND-YELLOW must be connected to the terminal in the plug which is marked by the letter E or by the safety earth symbol  or coloured GREEN or GREEN-AND-YELLOW.

The wire which is coloured BLUE must be connected to the terminal which is marked with the letter N or coloured BLACK.

The wire which is coloured BROWN must be connected to the terminal which is marked with the letter L or coloured RED.

For EU Countries



This product complies with the requirements of European Directives EMC 89/336/EEC and LVD 73/23/EEC.



# USING THE UNIT SAFELY

## INSTRUCTIONS FOR THE PREVENTION OF FIRE, ELECTRIC SHOCK, OR INJURY TO PERSONS

### About ⚠ WARNING and ⚠ CAUTION Notices

<b>⚠ WARNING</b>	Used for instructions intended to alert the user to the risk of death or severe injury should the unit be used improperly.
<b>⚠ CAUTION</b>	Used for instructions intended to alert the user to the risk of injury or material damage should the unit be used improperly. * Material damage refers to damage or other adverse effects caused with respect to the home and all its furnishings, as well to domestic animals or pets.

### About the Symbols

	The ⚠ symbol alerts the user to important instructions or warnings. The specific meaning of the symbol is determined by the design contained within the triangle. In the case of the symbol at left, it is used for general cautions, warnings, or alerts to danger.
	The ⓧ symbol alerts the user to items that must never be carried out (are forbidden). The specific thing that must not be done is indicated by the design contained within the circle. In the case of the symbol at left, it means that the unit must never be disassembled.
	The Ⓢ symbol alerts the user to things that must be carried out. The specific thing that must be done is indicated by the design contained within the circle. In the case of the symbol at left, it means that the power-cord plug must be unplugged from the outlet.

### ALWAYS OBSERVE THE FOLLOWING

#### ⚠ WARNING

- Before using this unit, make sure to read the instructions below, and the Owner's Manual. 



---

- Connect mains plug of this model to a mains socket outlet with a protective earthing connection. 

---

- Do not attempt to repair the unit, or replace parts within it (except when this manual provides specific instructions directing you to do so). Refer all servicing to your retailer, the nearest Roland Service Center, or an authorized Roland distributor, as listed on the "Information" page. 

---

- Never use or store the unit in places that are:
  - Subject to temperature extremes (e.g., direct sunlight in an enclosed vehicle, near a heating duct, on top of heat-generating equipment); or are 
  - Damp (e.g., baths, washrooms, on wet floors); or are 
  - Humid; or are
  - Exposed to rain; or are
  - Dusty; or are
  - Subject to high levels of vibration.

---

- The unit should be connected to a power supply only of the type described in the operating instructions, or as marked on the unit. 



---

- Do not excessively twist or bend the power cord, nor place heavy objects on it. Doing so can damage the cord, producing severed elements and short circuits. Damaged cords are fire and shock hazards! 

#### ⚠ WARNING

- This unit, either alone or in combination with an amplifier and headphones or speakers, may be capable of producing sound levels that could cause permanent hearing loss. Do not operate for a long period of time at a high volume level, or at a level that is uncomfortable. If you experience any hearing loss or ringing in the ears, you should immediately stop using the unit, and consult an audiologist. 





---

- Do not allow any objects (e.g., flammable material, coins, pins); or liquids of any kind (water, soft drinks, etc.) to penetrate the unit.   











---

- Immediately turn the power off, remove the power cord from the outlet, and request servicing by your retailer, the nearest Roland Service Center, or an authorized Roland distributor, as listed on the "Information" page when:
  - The power-supply cord, or the plug has been damaged; or
  - If smoke or unusual odor occurs
  - Objects have fallen into, or liquid has been spilled onto the unit; or
  - The unit has been exposed to rain (or otherwise has become wet); or
  - The unit does not appear to operate normally or exhibits a marked change in performance.

## ⚠ WARNING

- In households with small children, an adult should provide supervision until the child is capable of following all the rules essential for the safe operation of the unit. 
- Protect the unit from strong impact. (Do not drop it!) 
- Do not force the unit's power-supply cord to share an outlet with an unreasonable number of other devices. Be especially careful when using extension cords—the total power used by all devices you have connected to the extension cord's outlet must never exceed the power rating (watts/amperes) for the extension cord. Excessive loads can cause the insulation on the cord to heat up and eventually melt through. 
- Before using the unit in a foreign country, consult with your retailer, the nearest Roland Service Center, or an authorized Roland distributor, as listed on the "Information" page. 
- Do not put anything that contains water (e.g., flower vases) on this unit. Also, avoid the use of insecticides, perfumes, alcohol, nail polish, spray cans, etc., near the unit. Swiftly wipe away any liquid that spills on the unit using a dry, soft cloth. 

## ⚠ CAUTION

- The unit should be located so that its location or position does not interfere with its proper ventilation. 
- Always grasp only the plug on the power-supply cord when plugging into, or unplugging from an outlet. 
- At regular intervals, you should unplug the power plug and clean it by using a dry cloth to wipe all dust and other accumulations away from its prongs. Also, disconnect the power plug from the power outlet whenever the unit is to remain unused for an extended period of time. Any accumulation of dust between the power plug and the power outlet can result in poor insulation and lead to fire. 
- Try to prevent cords and cables from becoming entangled. Also, all cords and cables should be placed so they are out of the reach of children. 
- Never climb on top of, nor place heavy objects on the unit. 
- Never handle the power cord or its plug with wet hands when plugging into, or unplugging from, an outlet. 
- Before moving the unit, disconnect the power plug from the outlet, and pull out all cords from external devices. 
- Before cleaning the unit, turn off the power and unplug the power cord from the outlet. 
- Whenever you suspect the possibility of lightning in your area, pull the plug on the power cord out of the outlet. 
- Do not remove the speaker grille and speaker by any means. Speaker not user replaceable. Shock hazardous voltages and currents are present inside the enclosure. 

# IMPORTANT NOTES

In addition to the items listed under “IMPORTANT SAFETY INSTRUCTIONS” and “USING THE UNIT SAFELY” on pages 2, 3 and 4, please read and observe the following:

## Power Supply

- Do not connect this unit to same electrical outlet that is being used by an electrical appliance that is controlled by an inverter (such as a refrigerator, washing machine, microwave oven, or air conditioner), or that contains a motor. Depending on the way in which the electrical appliance is used, power supply noise may cause this unit to malfunction or may produce audible noise. If it is not practical to use a separate electrical outlet, connect a power supply noise filter between this unit and the electrical outlet.
- Before connecting this unit to other devices, turn off the power to all units. This will help prevent malfunctions and/or damage to speakers or other devices.
- Although the LEDs are switched off when the POWER switch is switched off, this does not mean that the unit has been completely disconnected from the source of power. If you need to turn off the power completely, first turn off the POWER switch, then unplug the power cord from the power outlet. For this reason, the outlet into which you choose to connect the power cord's plug should be one that is within easy reach and readily accessible.

## Placement

- Using the unit near power amplifiers (or other equipment containing large power transformers) may induce hum. To alleviate the problem, change the orientation of this unit; or move it farther away from the source of interference.
- This device may interfere with radio and television reception. Do not use this device in the vicinity of such receivers.
- Noise may be produced if wireless communications devices, such as cell phones, are operated in the vicinity of this unit. Such noise could occur when receiving or initiating a call, or while conversing. Should you experience such problems, you should relocate such wireless devices so they are at a greater distance from this unit, or switch them off.
- Do not expose the unit to direct sunlight, place it near devices that radiate heat, leave it inside an enclosed vehicle, or otherwise subject it to temperature extremes. Also, do not allow lighting devices that normally are used while their light source is very close to the unit (such as a piano light), or powerful spotlights to shine upon the same area of the unit for extended periods of time. Excessive heat can deform or discolor the unit.
- When moved from one location to another where the temperature and/or humidity is very different, water droplets (condensation) may form inside the unit. Damage or malfunction may result if you attempt to use the unit in this condition. Therefore, before using the unit, you must allow it to stand for several hours, until the condensation has completely evaporated.
- Do not allow rubber, vinyl, or similar materials to remain on the unit for long periods of time. Such objects can discolor or otherwise harmfully affect the finish.
- Do not paste stickers, decals, or the like to this instrument. Peeling such matter off the instrument may damage the exterior finish.
- Do not allow objects to remain on top of the unit while it is in operation.

## Maintenance

- For everyday cleaning wipe the unit with a soft, dry cloth or one that has been slightly dampened with water. To remove stubborn dirt, use a cloth impregnated with a mild, non-abrasive detergent. Afterwards, be sure to wipe the unit thoroughly with a soft, dry cloth.
- Never use benzine, thinners, alcohol or solvents of any kind, to avoid the possibility of discoloration and/or deformation.
- For routine care of the carpeted surfaces, use a brush with stiff bristles.

## Additional Precautions

- Use a reasonable amount of care when using the unit's buttons, sliders, or other controls; and when using its jacks and connectors. Rough handling can lead to malfunctions.
- When connecting / disconnecting all cables, grasp the connector itself—never pull on the cable. This way you will avoid causing shorts, or damage to the cable's internal elements.
- A small amount of heat will radiate from the unit during normal operation.
- To avoid disturbing your neighbors, try to keep the unit's volume at reasonable levels. You may prefer to use headphones, so you do not need to be concerned about those around you (especially when it is late at night).
- When you need to transport the unit, package it in the box (including padding) that it came in, if possible. Otherwise, you will need to use equivalent packaging materials.
- Use a cable from Roland to make the connection. If using some other make of connection cable, please note the following precautions.
  - Some connection cables contain resistors. Do not use cables that incorporate resistors for connecting to this unit. The use of such cables can cause the sound level to be extremely low, or impossible to hear. For information on cable specifications, contact the manufacturer of the cable.
- When transporting and storing the KC-150, be sure to secure the AC cord to the cord hook on the rear of the main unit.

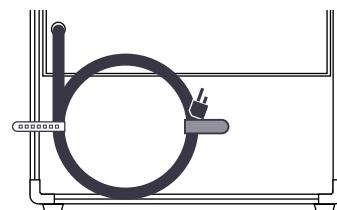

# Panel Descriptions

## Control Panel

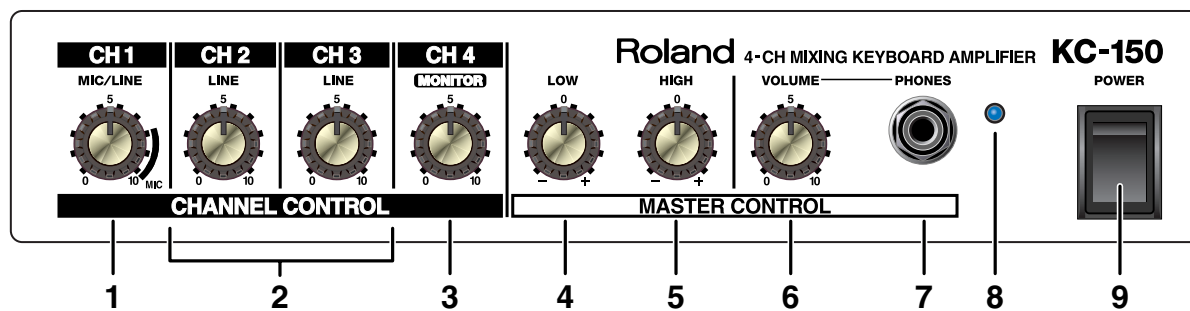

## Jack Panel

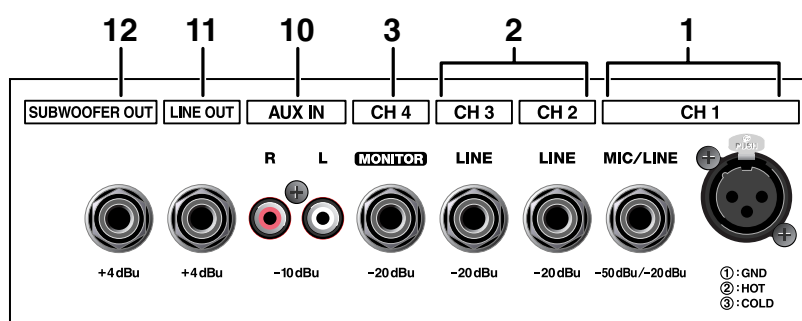

### CHANNEL CONTROL

#### 1. CH 1 knob / CH 1 Input Jacks

In addition to a 1/4" phone jack, this channel is equipped with a balanced XLR connector, useful for connecting microphones. This accepts input levels ranging from mic input (-50 dBu) to line level from sound modules and other equipment (-20 dBu).

#### 2. CH 2 and CH 3 knobs / CH 2 and CH 3 Input Jacks

Use these for connecting keyboards, sound modules, and other devices. They accept line level input (-20 dBu).

#### 3. CH 4 knob / CH 4 Input Jack

CH 4 is dedicated to monitoring channel. The signal that is input to CH 4 will not be output from the line out jack, but will be output only from the internal speaker and from the headphones. You can use the KC-150 for talkback from the main PA or as a monitor for live performances on stage or in other locations; this is an easy and convenient way to allow only the performer or performers to monitor the guide sounds from drum machines. Use this for connecting keyboards, sound modules, and other devices. This accepts line level input (-20 dBu).

\* If your setup does not use line output, CH4 can be used in the same way as the other channels.

### MASTER CONTROL

These adjust the tone and volume level for the built-in speakers or for headphones.

#### 4. LOW Knob

This adjusts the level of the bass range.

#### 5. HIGH Knob

This adjusts the level of the treble range.

#### 6. VOLUME Knob

This adjusts the total volume level of the unit's internal speaker. The SUBWOOFER OUT output is also changed. When connecting headphones, adjust the headphone volume level.

\* The VOLUME knob do not affect the line outs.

#### 7. PHONES Jack

This is for connecting headphones. The unit's speakers are deactivated when headphones are plugged in.

Also, no signals are output from SUBWOOFER OUT (p. 7).

\* Always be sure to lower the VOLUME knob to 0 whenever connecting and disconnecting headphones.

\* Although the PHONES jack accepts stereo plugs, the audio output is mono.

---

## 8. Power Indicator

This indicator illuminates when the power is on.

## 9. POWER Switch

This switches the power on and off.

- \* *If you need to turn off the power completely, first turn off the POWER switch, then unplug the power cord from the power outlet. Refer to "Power Supply" (p. 5).*
- \* *Always be sure to lower the volume on the KC-150 and any connected equipment to 0 whenever turning the power on or off.*
- \* *This unit is equipped with a protection circuit. A brief interval (a few seconds) after power up is required before the unit will operate normally.  
Slight pop noise may come from the speakers when the power is switched on, but this does not indicate a problem.*
- \* *Refer to p. 9 for the order in which to turn the power to connected devices on and off.*

## 10.AUX IN Jacks

These are RCA phono type input jacks.

You use these to connect equipment such as CD and MD players, and have them sound along with the equipment connected to channel 1 through channel 4.

They accept level input of -10 dBu.

- \* *To adjust the volume level of equipment connected to the AUX IN jacks, use the controls on such equipment.*
- \* *Even though the input signal may be in stereo, the signal is mixed internally to a mono signal.*

## 11.LINE OUT Jack

Connect mixers, recorders, and other such equipment here.

This output jack provides +4 dBu line level output.

- \* *The MASTER CONTROL knobs (the LOW, HIGH, and VOLUME controls) do not affect the output from LINE OUT.  
The signal that is input to CH 4 will not be output.*

## 12.SUBWOOFER OUT Jack

This lets you play even more powerful bass by connecting a powered subwoofer.

Provides full-range output, at an output level of +4 dBu.

You can use the MASTER CONTROL knobs (LOW, HIGH, and VOLUME) to adjust the tone and volume level of the signals output from SUBWOOFER OUT.

- \* *No signals are output from SUBWOOFER OUT when headphones are connected.*

# Making the Connections

Refer to the figure shown below to connect the KC-150 and the other equipment.

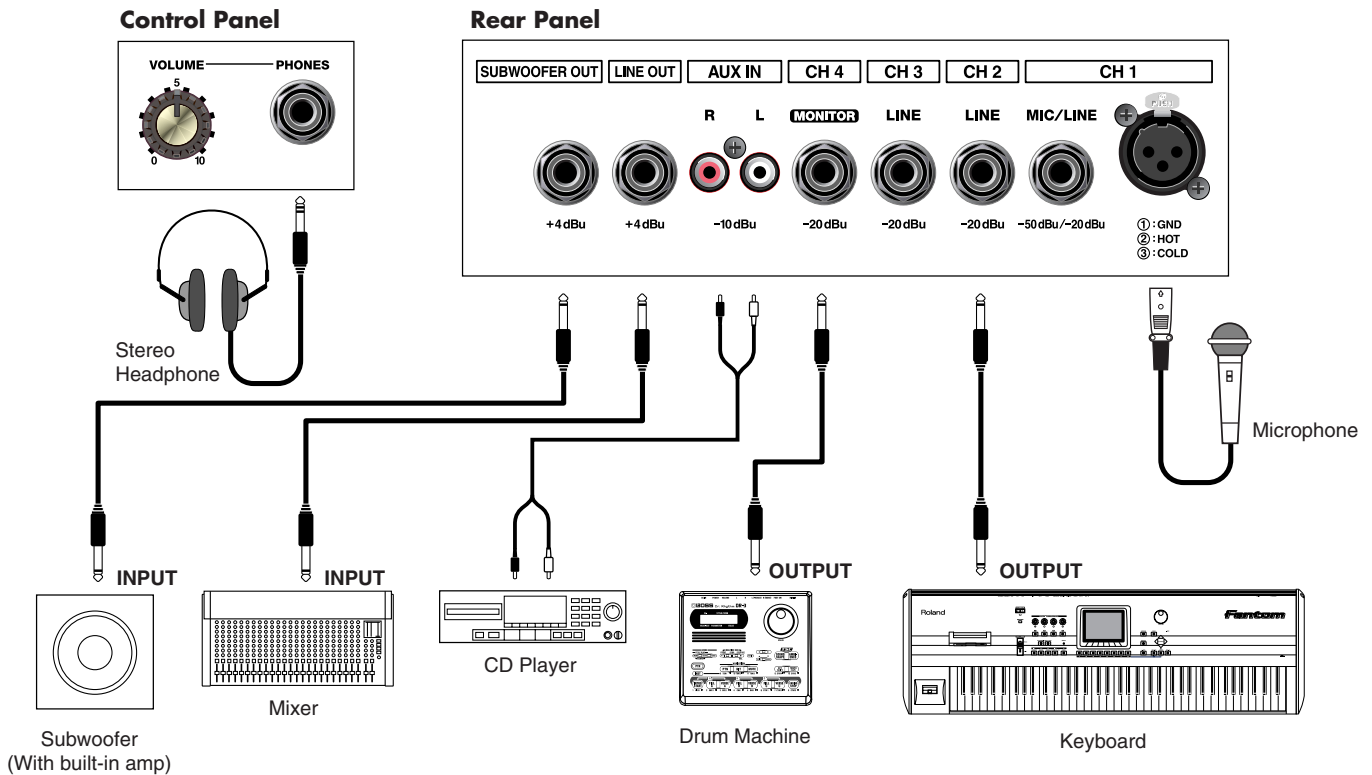

Here is an example of a setup that makes full use of the KC-150's mixer and monitor functions.

A microphone is input to CH 1, which accepts mic level input. Connect a keyboard, recorder, or other sound-generating device to the CH 2, CH 3 and CH 4 inputs.

- \* The signal that is input to CH 4 will not be output from the line out jack.
- \* To prevent malfunction and/or damage to speakers or other devices, always turn down the volume, and turn off the power on all devices before making any connections. Set all of the KC-150's channel volume knobs as well as the VOLUME knob to zero.
- \* The pin assignment for the XLR type connectors is as shown below. Before making any connections, make sure that this pin assignment is compatible with that of all your other devices.

- \* Howling could be produced depending on the location of microphone relative to speakers. This can be remedied by:
  1. Changing the orientation of the microphone.
  2. Relocating microphone at a greater distance from the speaker.
  3. Lowering volume levels.
- \* When connection cables with resistors are used, the volume level of equipment connected to the inputs (CH 1 through CH 4 and AUX IN) may be low. If this happens, use connection cables that do not contain resistors, such as those from the Roland PCS series.

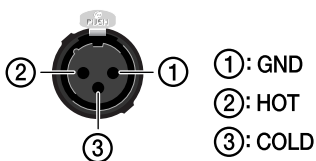



## Switching the Power On and Off

Once the connections have been completed, turn on power to your various devices in the order specified. By turning on devices in the wrong order, you risk causing malfunction and/or damage to speakers and other devices.

1. Make sure that all volume controls on the KC-150 and connected devices are set to 0.
2. Turn on all the devices connected to the KC-150's input jacks (CH 1 through CH 4 and AUX IN).
3. Turn on the KC-150.
4. Switch on any equipment connected to the KC-150's LINE OUT or SUBWOOFER OUT jacks.
5. Adjust the volume levels for the devices.
6. Before switching off the power, lower the volume on each of the devices in your system and then TURN OFF the devices in the reverse order to which they were switched on.

\* This unit is equipped with a protection circuit. A brief interval (a few seconds) after power up is required before the unit will operate normally. For protection from sudden big sound, always make sure to have the volume level turned down before switching on power. Even with the volume all the way down, you may still hear some sound when the power is switched on, but this is normal, and does not indicate a malfunction.

\* If you need to turn off the power completely, first turn off the POWER switch, then unplug the power cord from the power outlet. Refer to **Power Supply** (p. 5).

## About the Volume-level Settings

In order to get optimum sound from the KC-150 when performing, set the volume as described below.

1. Operate the CH 1 through CH 4 volume knobs to adjust the volume level for channels 1 through 4.

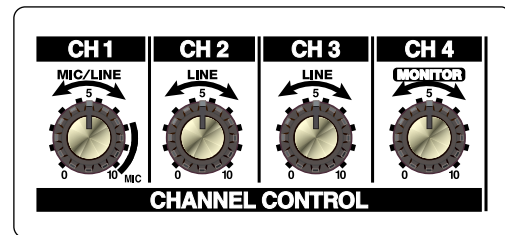

Adjust the volume balance for channels 1 through 4 at this time.

- \* To adjust the volume level of equipment connected to the AUX IN jacks, use the controls on such equipment.
2. Adjust the LOW and HIGH knobs to obtain the tone you want.
  3. Use the VOLUME knob to adjust the overall volume level.

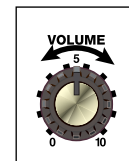

- \* If the sound is distorted, lower the CH 1 through CH 4 volume knobs, VOLUME knob and/or the volume knobs for devices connected to the input jacks (CH 1 through CH 4 and AUX IN).

# Using a Speaker Stand

By using a speaker stand, you can mount the KC-150 at the optimal height for use as a monitor speaker or simple PA device.

## WARNING

- The KC-150 is designed to be used only with speaker stands whose dimensions meet the specifications described below.  
Do not use it with a speaker stand that does not meet the following specifications.

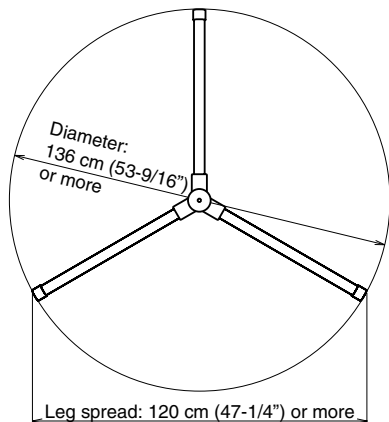
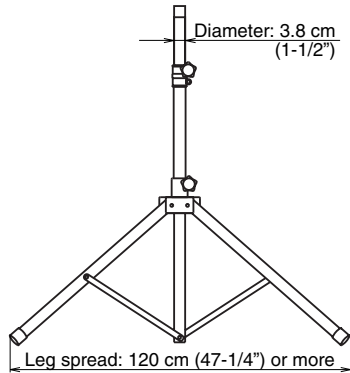

- When deciding on a stand to use with the KC-150, make sure to pick one that is capable of supporting its weight.

- Before use, adjust the speaker stand to a height of 140 cm (55-1/8") or less and a leg spread of 120 cm (47-1/4") or more, as shown in the figure below.

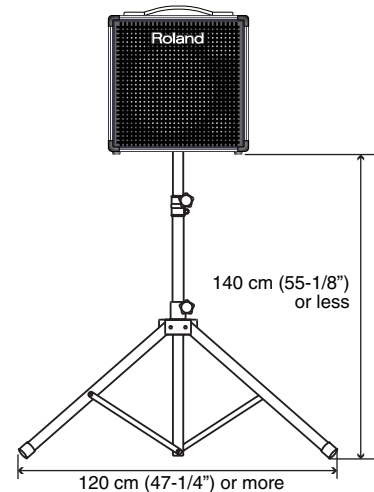

- Using a speaker stand that does not meet the specifications at left or that is adjusted to a height over 140 cm (55-1/8"), or a leg spread of less than 120 cm (47-1/4") may result in damage to equipment or injury due to the stand tipping over.
- When using KC-150 with a speaker stand, the speaker stand must be carefully placed so it is level and sure to remain stable.
- Cables connected to KC-150 should be given enough slack to prevent accidents that might result from someone tripping over them.
- To prevent accidents due to falls, do not place any object on the KC-150 when it's mounted on a speaker stand.
- Always have at least one other person assist you when mounting the KC-150 on a speaker stand, or when adjusting the height of the stand while the KC-150 remains mounted on it.

## Block Diagram

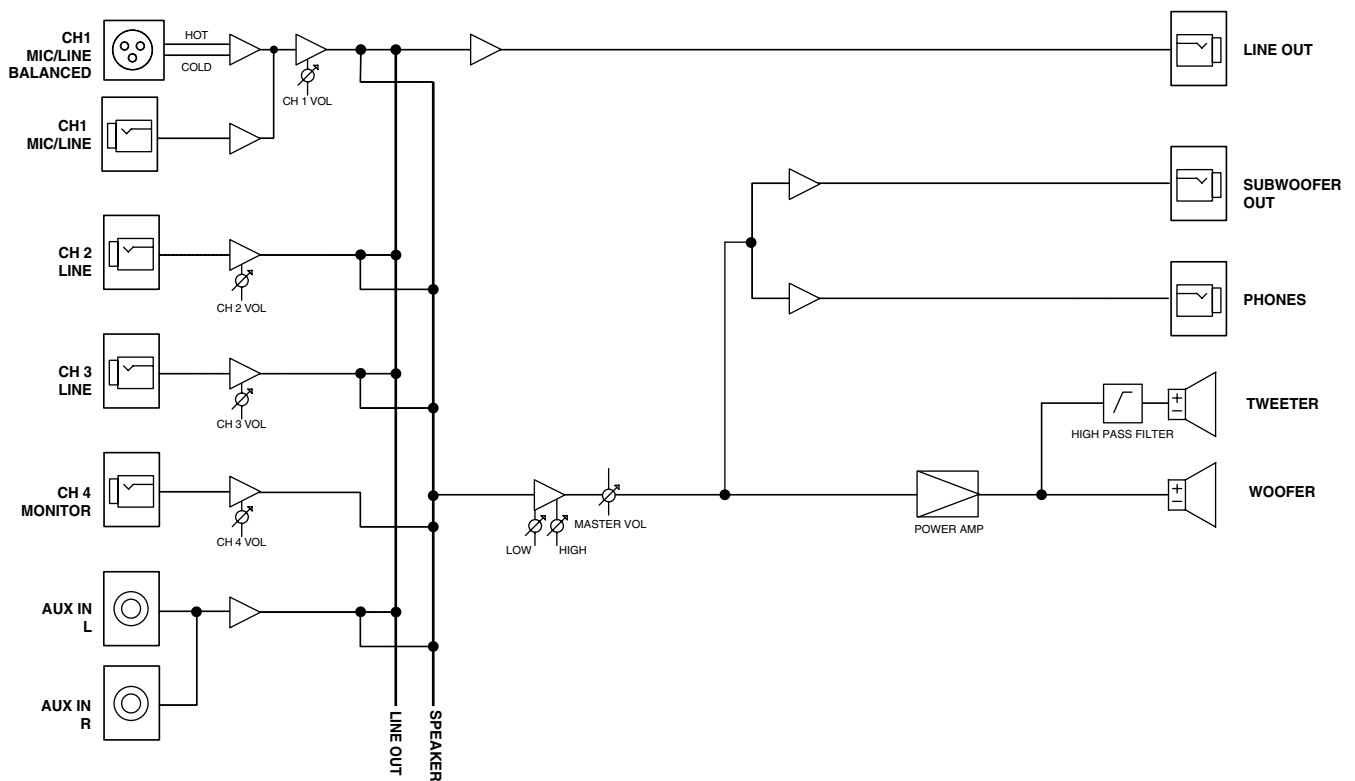

## Main Specifications

### Rated Power Output

65 W

### Nominal Input Level (1 kHz)

Input

Channel 1 (MIC/LINE): -50 – -20 dBu

Channel 2, 3 and 4 (LINE): -20 dBu

AUX IN: -10 dBu

### Nominal Output Level

LINE OUT: +4 dBu

SUBWOOFER OUT: +4 dBu

\* 0 dBu = 0.775 Vrms

### Speakers

30 cm (12 inches) x 1

Tweeter x 1

### Controls

Channel 1 (MIC/LINE) Volume Knob

Channel 2 (LINE) Volume Knob

Channel 3 (LINE) Volume Knob

Channel 4 (MONITOR) Volume Knob

Equalizer: LOW Knob, HIGH Knob

VOLUME Knob

POWER Switch

### Indicator

POWER

### Connectors

Channel 1 Input Jack (XLR type, 1/4" phone type)

Channel 2 Input Jack (1/4" phone type)

Channel 3 Input Jack (1/4" phone type)

Channel 4 Input Jack (1/4" phone type)

AUX IN Jack (RCA phono type)

LINE OUT Jack (1/4" phone type)

SUBWOOFER OUT Jack (1/4" phone type)

PHONES Jack (1/4" TRS phone type, mono signal output)

### Power Supply

AC 117 V, AC 230 V, AC 240 V: 50/60 Hz

AC 220 V: 60 Hz

### Power Consumption

55 W

### Dimensions

480 (W) x 295 (D) x 435 (H) mm

18-15/16 (W) x 11-5/8 (D) x 17-1/8 (H) inches

### Weight

15.5 kg

34 lbs 3 oz

### Accessory

Owner's Manual

\* In the interest of product improvement, the specifications and/or appearance of this unit are subject to change without prior notice.

Roland Corporation

