







evolution wireless 

# SKM 100



Instruction manual

Tastensymbole / Button icons / Icônes de touches /  
 Simboli dei tasti / Símbolos de las teclas / Símbolos dos botões /  
 СИМВОЛЫ КНОПОК / 按键图标

	Taste ON/OFF / ON/OFF button / Touche ON/OFF / Tasto ON/OFF / Botón ON/OFF / Botão ON/OFF / Кнопка ON/OFF / 开关键 ON/OFF
	ON/OFF drücken / Press the ON/OFF button / Appuyer sur la touche ON/OFF / Premere ON/OFF / Pulsar ON/OFF / Premir ON/OFF / Нажать ON/OFF / 按 ON/OFF 键
	Multifunktionsschalter / Multi-function switch / Commutateur multifonctions / Interruttore multifunzione / Interruptor multifunción / Interruptor multifunções / Многофункциональный переключатель / 多功能开关
	Multifunktionsschalter drücken / Press the multi-function switch / Appuyer sur le commutateur multifonctions / Premere l'interruttore multifunzione / Pulsar interruptor multifunción / Premir o interruptor multifunções / Нажать многофункциональный переключатель / 按多功能开关
	Multifunktionsschalter nach oben/unten bewegen / Move the multi-function switch upwards/downward / Déplacer le commutateur multifonctions vers le haut/bas / Spostare l'interruttore multifunzione verso l'alto/verso il basso / Mover hacia arriba/abajo el interruptor multifunción / Mover o interruptor multifunções para cima/baixo / Переместить многофункциональный переключатель вверх/вниз / 向上 / 向下拨动多功能开关
	Multifunktionsschalter nach oben/unten bewegen, dann drücken / Move the multi-function switch upwards/ downward, then press it / Déplacer le commutateur multifonctions vers le haut/bas, puis appuyer sur le commutateur / Spostare l'interruttore multifunzione verso l'alto/verso il basso, quindi premere / Mover hacia arriba/ abajo el interruptor multifunción y pulsar entonces / Mover o interruptor multifunções para cima/baixo, depois premir / Переместить многофункциональный переключатель вверх/вниз, затем нажать / 向上 / 向下拨动, 然后按下多功能开关

# Contents

<b>Important safety instructions</b> .....	2
<b>The SKM 100 G3 radio microphone family</b> .....	3
The frequency bank system .....	3
Areas of application .....	4
<b>Delivery includes</b> .....	5
<b>Product overview</b> .....	6
Overview of the SKM 100 radio microphone .....	6
Overview of the displays .....	7
<b>Putting the radio microphone into operation</b> .....	8
Inserting the batteries/accupack .....	8
Charging the accupack .....	9
Changing the microphone head .....	9
Changing the color-coded protection ring .....	10
<b>Using the radio microphone</b> .....	11
Switching the radio microphone on/off .....	11
Deactivating the lock mode temporarily .....	12
Deactivating the RF signal .....	12
Selecting a standard display .....	12
<b>Using the operating menu</b> .....	13
The buttons .....	13
Overview of the operating menu .....	13
Working with the operating menu .....	14
<b>Adjusting settings via the operating menu</b> .....	16
The main menu "Menu" .....	16
The extended menu "Advanced Menu" .....	18
<b>Adjustment tips</b> .....	20
Synchronizing the radio microphone with a receiver	20
<b>Cleaning the radio microphone</b> .....	21
<b>If a problem occurs ...</b> .....	22
<b>Specifications</b> .....	23
Polar diagrams and frequency response curves of the microphone heads .....	24
<b>Manufacturer Declarations</b> .....	26



For more detailed information on the individual sections of this instruction manual, visit the SKM 100 G3 product page on our website at [www.sennheiser.com](http://www.sennheiser.com).



There you can also view an animated instruction manual.

# Important safety instructions

- Read this instruction manual.
- Keep this instruction manual. Always include this instruction manual when passing the device on to third parties.
- Heed all warnings and follow all instructions.
- Clean the device only with a slightly damp cloth.
- Do not place the device near any heat sources such as radiators, stoves, or other devices (including amplifiers) that produce heat.
- Only use attachments/accessories specified by Sennheiser.
- When replacement parts are required, only use replacement parts specified by Sennheiser or those having the same characteristics as the original part. Unauthorized substitutions may result in fire, electric shock, or other hazards.
- Refer all servicing to qualified service personnel.  
Servicing is required if the device has been damaged in any way, liquid has been spilled, objects have fallen inside, the device has been exposed to rain or moisture, does not operate properly or has been dropped.
- **WARNING:** To reduce the risk of short circuits, do not use the device near water and do not expose it to rain or moisture.

### Intended use

Intended use of the ew 100 G3 series devices includes:

- having read these instructions especially the chapter “Important safety instructions”,
- using the devices within the operating conditions and limitations described in this instruction manual.

“Improper use” means using the devices other than as described in these instructions, or under operating conditions which differ from those described herein.

## The SKM 100 G3 radio microphone family

The SKM 100 G3 radio microphone is part of the evolution wireless series generation 3 (ew G3). With this series, Sennheiser offers high-quality state-of-the-art RF transmission systems with a high level of operational reliability and ease of use. Transmitters and receivers permit wireless transmission with studio-quality sound.

Features of the evolution wireless 100 G3 series:

- Optimized PLL synthesizer and microprocessor technology
- HDX noise reduction system
- Pilot tone squelch control
- True diversity technology
- Switching bandwidth of 42 MHz
- Increased immunity to intermodulation and interferences in multi-channel operation
- Interchangeable microphone heads, allowing the use of different pick-up patterns and sensitivities

### The frequency bank system

Please note: Frequency usage is different for each country. Your Sennheiser partner will have all the necessary details on the available legal frequencies for your area.

The radio microphone is available in 6 UHF frequency ranges with 1,680 transmission frequencies per frequency range:

Range A:	516 – 558 MHz	Range C:	734 – 776 MHz
Range G:	566 – 608 MHz	Range D:	780 – 822 MHz
Range GB:	608 – 648 MHz	Range E:	823 – 865 MHz
Range B:	626 – 668 MHz		

Each frequency range (A–E, G, GB) offers 21 frequency banks with up to 12 channels each:

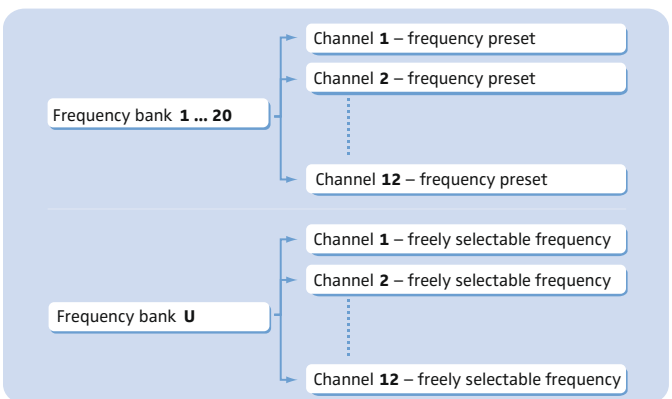

Each of the channels in the frequency banks “1” to “20” has been factory-preset to a fixed transmission frequency (frequency preset). The factory-preset frequencies within one frequency bank are intermodulation-free. These frequencies cannot be changed.

For an overview of the frequency presets, please refer to the supplied frequency information sheet. Updated versions of the frequency information sheet can be downloaded from the SKM 100 G3 product page on our website at [www.sennheiser.com](http://www.sennheiser.com).

The frequency bank “U” allows you to freely select and store transmission frequencies. It might be that these transmission frequencies are **not** intermodulation-free.

## Areas of application

The radio microphone family can be combined with the EM 100 G3 stationary receiver.

The EM 100 G3 stationary receiver is available in the same UHF frequency ranges and is equipped with the same frequency bank system with factory-preset frequencies. This has the advantage that

- a transmission system is ready for immediate use after switch-on,
- several transmission systems can be operated simultaneously on the preset frequencies without causing intermodulation interference.



Radio microphone	Receiver	Interchangeable microphone heads
SKM 100-835 G3 <sup>*)</sup>	EM 100 G3	MMD 835-1
SKM 100-845 G3 <sup>*)</sup>		MMD 845-1
SKM 100-865 G3 <sup>*)</sup>		MME 865-1

\* The name of the radio microphone is a combination of the name of the transmitter and the name of the microphone head:

Transmitter + Microphone head = Name of the radio microphone  
 SKM 100 G3 + MMD 835-1 = SKM 100-835 G3

The name and pick-up pattern of the microphone head are printed on the sound inlet basket of the radio microphone.

Overview of the microphone heads:

Microphone head	Type	Pick-up pattern
MMD 835-1	dynamic	 cardioid
MMD 845-1	dynamic	 super-cardioid
MME 865-1	condenser	 super-cardioid

## Delivery includes

The packaging contains the following items:

- 1 SKM 100 G3 radio microphone incl. microphone head
- 2 AA size batteries, 1.5 V
- 1 microphone clamp
- 1 instruction manual
- 1 frequency information sheet

## Product overview

### Overview of the SKM 100 radio microphone

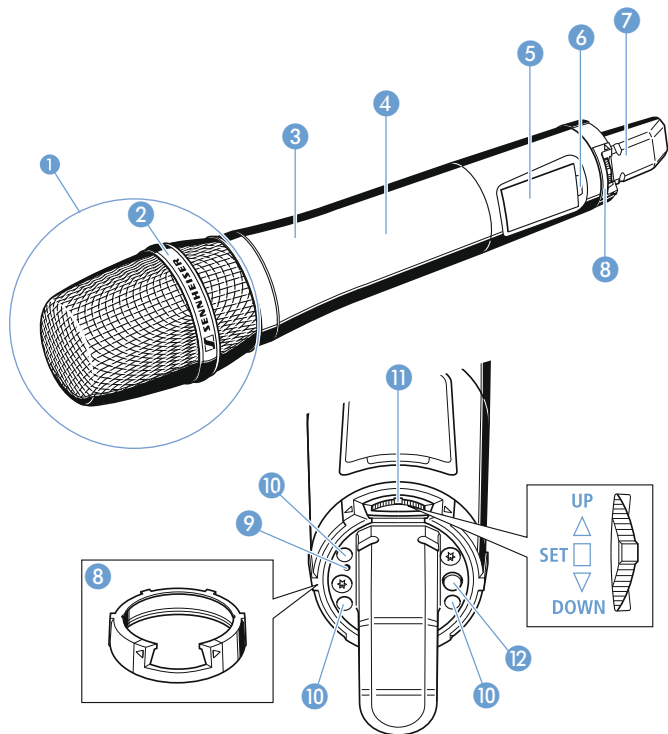

- 1 Microphone head (interchangeable)
- 2 Name and pick-up pattern of the microphone head (siehe Seite 4)
- 3 Body of radio microphone
- 4 Battery compartment (not visible from outside)
- 5 Display panel, backlit in orange
- 6 Infra-red interface
- 7 Antenna
- 8 Color-coded protection ring; available in different colors
- 9 Operation and battery status indicator, red LED (lit = ON/flashing = LOW BAT)
- 10 Charging contacts
- 11 Multi-function switch:  
▼ (DOWN), ▲ (UP) and ■ (SET)
- 12 ON/OFF button (serves as the ESC (cancel) key in the operating menu)





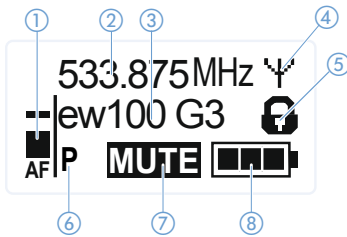

## Overview of the displays

After switch-on, the radio microphone displays the standard display "Frequency/Name". For further illustrations and examples of the different standard displays, refer to Seite 12.

The display backlighting is automatically reduced after approx. 20 seconds.

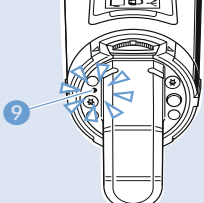

Display	Meaning
① Audio level "AF"	Modulation of the radio microphone with peak hold function
② Frequency	Current transmission frequency
③ Name	User selectable name
④ Transmission icon	RF signal is being transmitted
⑤ Lock mode icon	Lock mode is activated
⑥ "P" (Pilot)	Pilot tone transmission is activated
⑦ "MUTE"	Audio signal is muted
⑧ Battery status	Charge status: <ul style="list-style-type: none"> <li> approx. 100%</li> <li> approx. 70%</li> <li> approx. 30%</li> <li> charge status is critical, the red <b>LOW BATT LED</b> ⑨ is flashing:</li> </ul> 

## Putting the radio microphone into operation

### Inserting the batteries/accupack

For powering the radio microphone, you can either use two 1.5 V AA size batteries or the rechargeable Sennheiser BA 2015 accupack.

- ▶ Unscrew the lower part of the radio microphone from the radio microphone's body ③ by turning it counterclockwise.

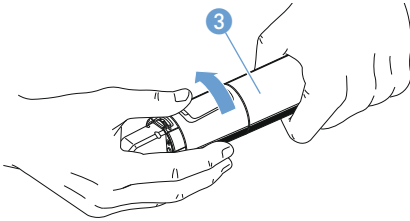

When unscrewing the radio microphone during operation, the muting function is automatically activated. "MUTE" appears on the display panel.

When screwing the lower part of the radio microphone back to the radio microphone's body, the muting is canceled.

- ▶ Slide back the lower part of the radio microphone as far as it will go.

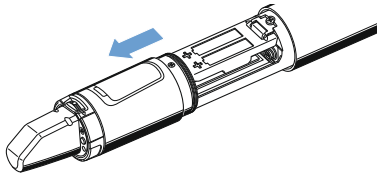

- ▶ Open the battery compartment cover ⑬.

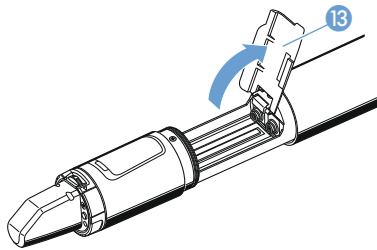

- ▶ Insert the batteries or the BA 2015 accupack as shown on the battery compartment cover. Observe correct polarity when inserting the batteries/accupack.

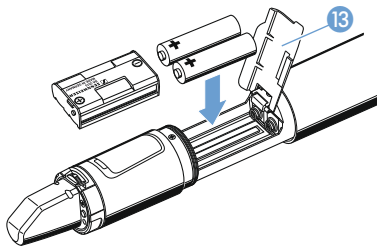

- ▶ Close the battery compartment cover ⑬.
- ▶ Push the battery compartment into the radio microphone's body.
- ▶ Screw the lower part of the radio microphone back to the radio microphone's body ③.

## Charging the accupack

To charge the radio microphone with the inserted BA 2015 accupack (optional accessory):

- ▶ Use the LA 2 charging adapter to insert the radio microphone into the L 2015 charger (both the charger and the charging adapter are available as optional accessories – information on accessories can be found on our web site at [www.sennheiser.com](http://www.sennheiser.com)).

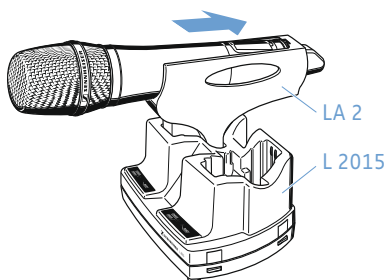

The L 2015 charger can only charge individual BA 2015 accupacks or – when used in conjunction with the LA 2 charging adapter – the radio microphone with the BA 2015 accupack inserted. Standard batteries (primary cells) or individual rechargeable battery cells cannot be charged.

## Changing the microphone head

The microphone head ① is easy to change.

- ▶ Unscrew the microphone head ①.

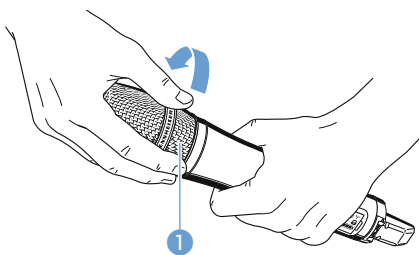

Do not touch the contacts of the radio microphone nor the contacts of the microphone head ①. The contacts can become dirty or damaged if touched.

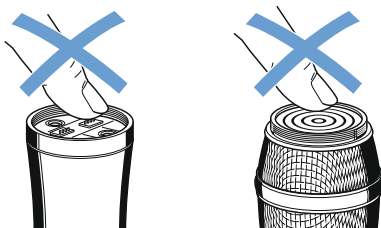

When unscrewing the microphone head ① during operation, the muting function is automatically activated. "MUTE" appears on the display panel.

When screwing the microphone head ① back to the radio microphone, the muting is canceled.

- ▶ Screw the desired microphone head to the radio microphone.

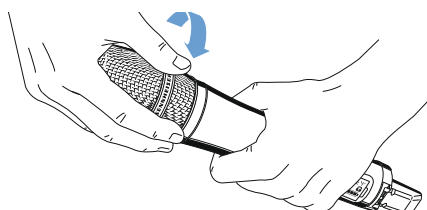

- ▶ Put the radio microphone back into operation.

## Changing the color-coded protection ring

The color-coded protection ring 8 prevents the multi-function switch 11 from accidental operation. Protection rings 8 in different colors are available as accessories (information on accessories can be found on our web site at [www.sennheiser.com](http://www.sennheiser.com)). The protection rings allow you to clearly identify each radio microphone.

- ▶ Remove the color-coded protection ring 8 as shown.

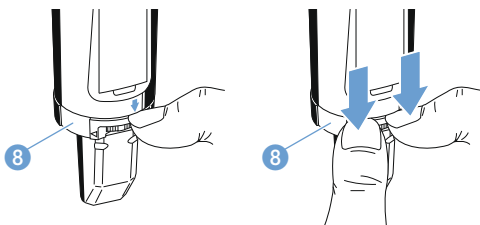

- ▶ Put on a new protection ring 8 as shown.

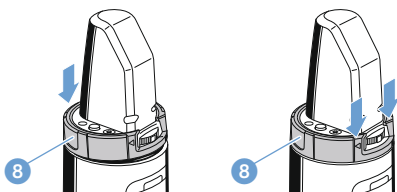

## Using the radio microphone

To establish a transmission link, proceed as follows:

1. Switch the receiver on (see the instruction manual of the receiver).
2. Switch the radio microphone on (see below).  
The transmission link is established and the receiver's RF level display "RF" reacts.

### Switching the radio microphone on/off

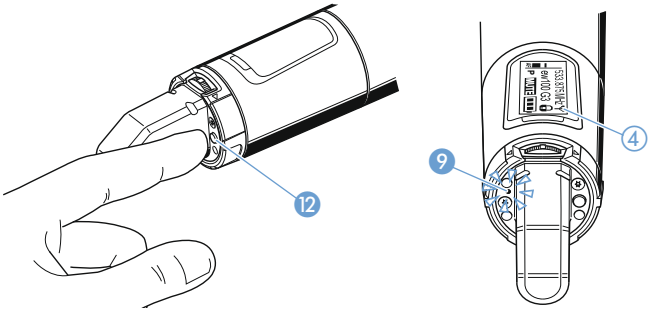



To switch the radio microphone **on** (online operation):

- ON/OFF**  Briefly press the **ON/OFF** button **12**.  
The radio microphone transmits an RF signal. The transmission icon **4** is displayed.  
The red **ON LED** **9** lights up and the standard display "Frequency/Name" appears on the display panel.



You can switch the radio microphone on and **deactivate the RF signal on switch-on**. For more information, see below.



To switch the radio microphone **off**:

-  If necessary, deactivate the lock mode (siehe Seite 12).
- ON/OFF**  Press the **ON/OFF** button **12** until "OFF" appears on the display panel. The red **ON LED** **9** goes off and the display panel turns off.



When in the operating menu, pressing the **ON/OFF** button **12** will cancel your entry (ESC function) and return you to the current standard display.

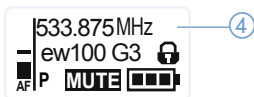

To switch the radio microphone **on** and to **deactivate the RF signal on switch-on** (offline operation):

- ON/OFF**  Press the **ON/OFF** button **12** until "RF Mute On?" appears on the display panel.
-  Press the multi-function switch **11**.  
The transmission frequency is displayed but the radio microphone does not transmit an RF signal. The transmission icon **4** is not displayed.



Use this function to save battery power or to prepare a radio microphone for use during live operation without causing interference to existing transmission links.

To activate the RF signal:

- ON/OFF**  Briefly press the **ON/OFF** button **12**.  
"RF Mute Off" appears on the display panel.
-  Press the multi-function switch **11**.  
The transmission icon **4** is displayed again.

## Deactivating the lock mode temporarily

You can activate or deactivate the automatic lock mode via the “Auto Lock” menu item (siehe Seite 17). If the lock mode is activated, you have to temporarily deactivate it in order to be able to operate the radio microphone:

 ▶ Move the multi-function switch upwards/downwards.  
“Unlock?” appears on the display panel.

 ▶ Press the multi-function switch.  
The lock mode is temporarily deactivated:

How you are using the radio microphone determines how long the lock mode remains deactivated:

### When you are in the operating menu

The lock mode is deactivated as long as you are in the operating menu.

### When one of the standard displays is shown

The lock mode is automatically activated after 10 seconds.

Prior to this, the lock mode icon  flashes, indicating that the lock mode is being activated.



## Deactivating the RF signal

### Deactivating the RF signal on switch-on

For information on deactivating the RF signal on switch-on, refer to the chapter „Switching the radio microphone on/off“ auf Seite 11.

### Deactivating the RF signal during operation

-  ▶ When one of the standard displays is shown on the display panel, briefly press the **ON/OFF** button.  
“RX Mute On?” appears on the display panel.
- ▶ Proceed as described on Seite 11.

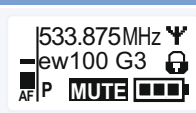
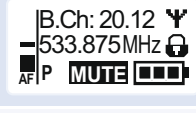
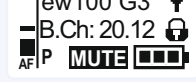

## Selecting a standard display

 ▶ Move the multi-function switch to select a standard display:

Contents of the display	Selectable standard display
	“Frequency/Name”
	“Channel/Frequency”
	“Channel/Name”

## Using the operating menu

### The buttons

Button	Function of the button
Press the ON/OFF button 	<ul style="list-style-type: none"> <li>Switches the radio microphone on and off</li> <li> Cancels the entry and returns to the current standard display (ESC function)</li> <li> Deactivates the RF signal (special function, siehe Seite 12)</li> </ul>
Press the multi-function switch 	<ul style="list-style-type: none"> <li>Changes from the current standard display to the operating menu</li> <li> Calls up a menu item</li> <li> Enters a submenu</li> <li> Stores the settings and returns to the operating menu</li> </ul>
Move the multi-function switch 	<ul style="list-style-type: none"> <li>Selects a standard display</li> <li> Changes to the next/previous menu item</li> <li> Changes the setting of a menu item</li> </ul>

### Overview of the operating menu

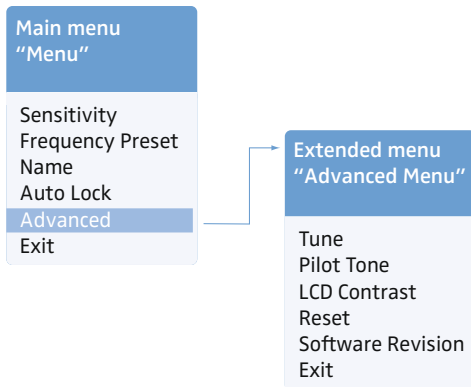

Display	Function of the menu item
Main menu "Menu"	
Sensitivity	Adjusts the sensitivity "AF" (siehe Seite 16)
Frequency Preset	Changes the frequency bank and the channel (siehe Seite 16)
Name	Enters the transmitter name (siehe Seite 17)
Auto Lock	Activates/deactivates the automatic lock mode (siehe Seite 17)
Advanced	Calls up the extended menu "Advanced Menu" (siehe Seite 18)
Exit	Exits the operating menu and returns to the current standard display
Extended menu "Advanced Menu"	
Tune	Sets the transmission frequencies for the frequency bank "U" (siehe Seite 18) Special function: Sets a channel and a transmission frequency for the frequency bank "U" (siehe Seite 18)
Pilot Tone	Activates/deactivates the pilot tone transmission (siehe Seite 19)

## Using the operating menu

Display	Function of the menu item
LCD Contrast	Adjusts the contrast of the display panel (siehe Seite 19)
Reset	Resets the radio microphone (siehe Seite 19)
Software Revision	Displays the current software revision (siehe Seite 19)
Exit	Exits the extended menu "Advanced Menu" and returns to the main menu

## Working with the operating menu



If the lock mode is activated, you have to deactivate it in order to be able to work with the operating menu (siehe Seite 12).

By way of example of the "Sensitivity" menu, this section describes how to use the operating menu.

### Changing from the current standard display to the operating menu



- ▶ Press the multi-function switch. The current standard display is replaced by the main menu. The last selected menu item is displayed.

### Selecting a menu item



- ▶ Move the multi-function switch to change to the "Sensitivity" menu item. The current setting of the selected menu item is displayed:

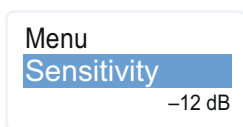

### Changing and storing settings

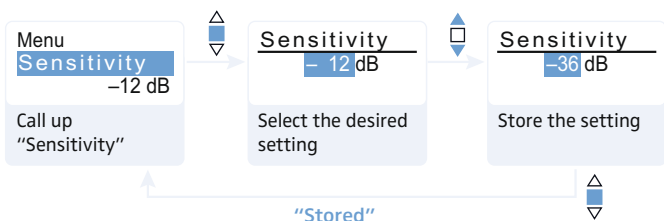

- ▶ Press the multi-function switch to call up the menu item.



- ▶ Move the multi-function switch to adjust the input sensitivity.



- ▶ Press the multi-function switch to store the setting.

The multi-function switch features a "fast search" function:

Multi-function switch	Display
Move upwards (▲)	jumps to the previous menu item/setting
Move downwards (▼)	jumps to the next menu item/setting
Move upwards/downwards (▲/▼) and hold in this position	cycles continuously



### Canceling an entry

-  Press the **ON/OFF** button to cancel the entry.  
The current standard display appears on the display panel.

To return to the last edited menu item:

-  Press the multi-function switch so many times until the last edited menu item appears.

### Exiting a menu item

-  Change to the “Exit” menu item.

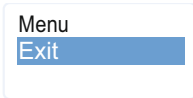

-  Confirm your selection.  
You return to the next higher menu level.

To directly return to the current standard display:

-  Press the **ON/OFF** button.

## Adjusting settings via the operating menu



Make use of the possibility to adjust settings via the operating menu of your receiver and to transfer these settings to the radio microphone. For more information, refer to the instruction manual of the receiver. The relevant information is marked with the sync icon.



For more detailed information on the operating menu, visit the SKM 100 G3 product page at [www.sennheiser.com](http://www.sennheiser.com).

### The main menu "Menu"

#### Adjusting the input sensitivity – "Sensitivity"

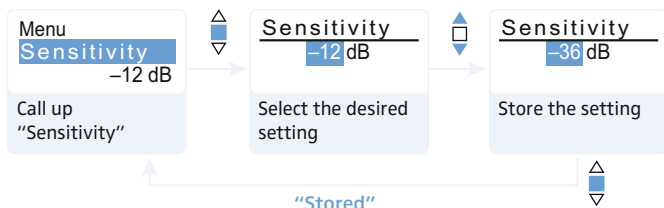

Adjustment range: 0 to -48 dB, adjustable in steps of 6 dB

The transmitter's audio level display "AF" always indicates the audio level, even if the radio microphone is muted, e.g. allowing you to check the adjusted sensitivity before live operation.

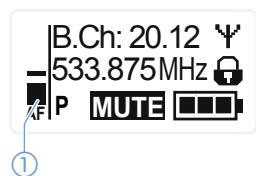

Input sensitivity adjusted ...	Effect/display
... too high	Close talking distances, speakers with loud voices or loud music passages cause overmodulation in the transmission link. The audio level display "AF" ① shows full deflection for the duration of the overmodulation.
... correctly	The audio level display "AF" ① shows full deflection only during the loudest passages.
... too low	The transmission link is undermodulated. This results in a signal with high background noise.

The following figures are a guide to the best settings:

Transmission situation	Sensitivity setting
Loud music/vocals	-48 to -18 dB
Presentations	-18 to -12 dB
Interviews	-12 to 0 dB

#### Selecting the frequency bank and the channel manually – "Frequency Preset"

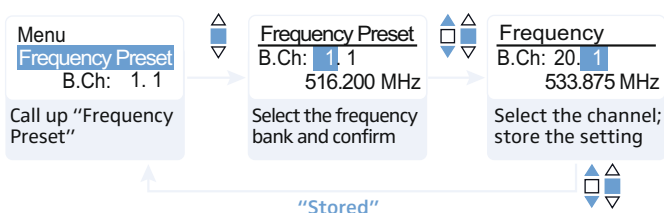

When you are in the "Frequency Preset" menu item, the RF signal is deactivated.

Overview of the frequency banks and channels:

Frequency bank	Channels	Type
"1" to "20"	up to 12 per frequency bank	System bank: frequencies are factor-preset
"U"	up to 12	User bank: frequencies are freely selectable

When setting up multi-channel systems, please observe the following:

Only the factory-preset frequencies within one frequency bank are intermodulation-free (siehe Seite 20). Radio microphone and receiver of a transmission link have to be set to the same frequency. It is vital to observe the notes on frequency selection on Seite 20.

## Entering a name – "Name"

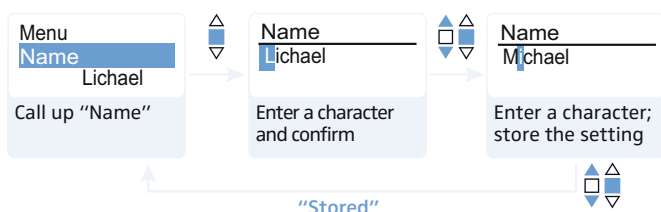

Via the "Name" menu, you can enter a freely selectable name (e.g. the name of the performer) for the radio microphone.

The name can be displayed on the standard displays "Frequency/Name" and "Channel/Name". The name can consist of up to 8 characters such as:

- letters (without pronunciation marks),
- numbers from 0 to 9,
- special characters and spaces.

To enter a name, proceed as follows:





- ▶ Move the multi-function switch to select a character.

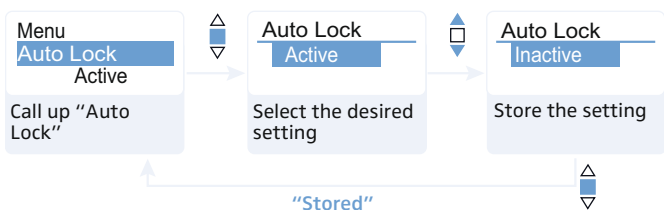

- ▶ Press the multi-function switch to change to the next segment/character or to store the complete entry.

## Activating/deactivating the automatic lock mode – "Auto Lock"



The lock mode prevents that the radio microphone is accidentally switched off or programmed during operation. The lock mode icon ⑤  on the current standard display indicates that the lock mode is activated.



- ▶ Move the multi-function switch to select the desired setting.

For information on how to use the lock mode, refer to Seite 12.

## The extended menu "Advanced Menu"



### Setting transmission frequencies and the frequency bank "U" – "Tune"

When you have selected one of the system banks and then select the "Tune" menu, the radio microphone automatically switches to channel 1 of the frequency bank "U". In this case, "U.1" briefly appears on the display panel. Upon delivery, the channels of the frequency bank "U" are not assigned a transmission frequency.

When you are in the "Tune" menu item, the RF signal is deactivated.

Via the "Tune" menu item, you can set a transmission frequency to be stored in the current channel or you can select a different channel and assign it a transmission frequency. It is vital to observe the notes on frequency selection on Seite 20.

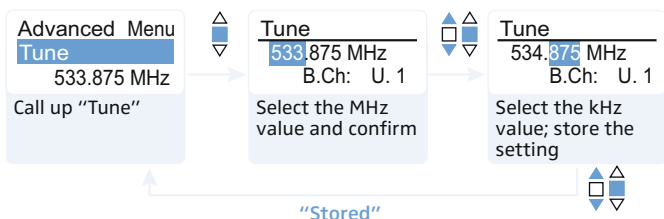

### Setting a transmission frequency for the current channel

-  ▶ Move the multi-function switch until the "Tune" menu item appears.
-  ▶ Press the multi-function switch. The frequency selection appears.



- ▶ Set the desired frequency.
-  ▶ Press the multi-function switch. Your settings are stored. You are back to the operating menu.

### Selecting a channel and assigning this channel a frequency

-  ▶ Move the multi-function switch until the "Tune" menu item appears.
-  ▶ Press the multi-function switch until the frequency bank selection appears.

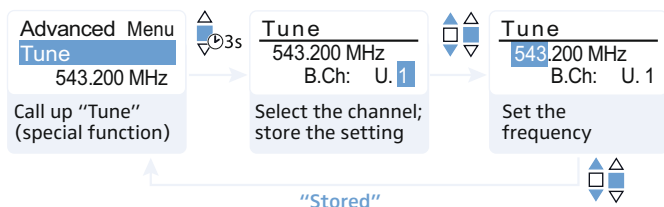

- ▶ Set the desired channel.
-  ▶ Press the multi-function switch. The frequency selection appears.
- ▶ Set the desired frequency.

## Activating/deactivating the pilot tone transmission – “Pilot Tone”

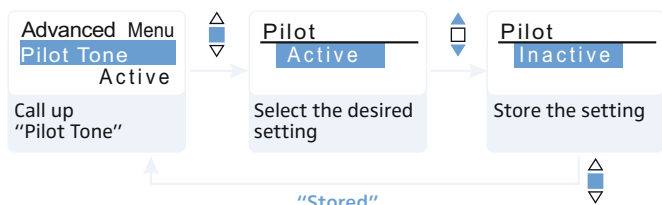

The radio microphone adds an inaudible pilot tone to the audio signal. The receiver detects and evaluates the pilot tone, and is thus able to identify the signal of the matching transmitter and mute all others. The pilot tone supports the receiver’s squelch function.

Devices of the ew 100 G1 series (generation 1) do not support the pilot tone function. Therefore, please observe the following when combining a radio microphone or receiver of the ew 100 G3 series (generation 3) with devices from an earlier evolution wireless generation:

Radio microphone	Receiver	Make sure to ...
ew G3/ew G2	ew G3/ew G2	... activate the pilot tone function on both radio microphone and receiver.
ew G3	ew G1	... deactivate the pilot tone function on the ew 100 G3 radio microphone.
ew G1	ew G3	... deactivate the pilot tone function on the ew 100 G3 receiver.

## Adjusting the contrast of the display panel – “LCD Contrast”

You can adjust the contrast of the display panel in 16 steps.

## Loading the factory-preset default settings – “Reset”

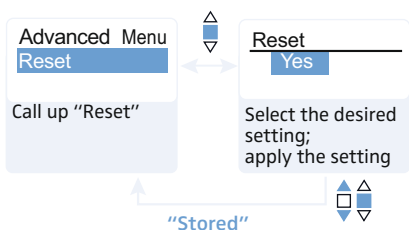

When resetting the radio microphone, only the selected settings for the pilot tone and for the frequency bank “U” remain unchanged.

## Displaying the software revision – “Software Revision”

You can display the current software revision of the radio microphone.

## Adjustment tips

### Synchronizing the radio microphone with a receiver

When synchronizing the radio microphone with a receiver, please observe the following:

- ▶ Only use a radio microphone and a receiver from the same frequency range (see the type plate on the radio microphone and the receiver).
- ▶ Make sure that the desired frequencies are listed in the enclosed frequency information sheet.
- ▶ Make sure that the desired frequencies are approved and legal in your country and, if necessary, apply for an operating license.

### Synchronizing the radio microphone with the receiver – individual operation

Upon delivery, the radio microphone and the receiver are synchronized with each other. However, if you cannot establish a transmission link between radio microphone and receiver, you have to synchronize the channels of the devices.

For information on automatic synchronization of the radio microphone with the receiver (individual operation), refer to the instruction manual of the receiver. This information is marked with the  icon.

Alternatively, you can set the channel on the radio microphone manually:

- ▶ Make sure that you set the radio microphone to the same frequency bank and the same channel as the receiver (siehe Seite 16).

If you still cannot establish a transmission link, refer to the chapter „If a problem occurs ...“ auf Seite 22.

### Synchronizing radio microphones with receivers – multi-channel operation

Combined with ew 100 G3 receivers, ew 100 G3 radio microphones can form transmission links that can be used in multi-channel systems. In order to ensure an intermodulation-free transmission, use the same frequency bank for all transmission links.

For information on automatic synchronization of radio microphones with receivers (multi-channel operation), refer to the instruction manual of your receiver.

## Cleaning the radio microphone

**CAUTION!** Liquids can damage the electronics of the radio microphone!

Liquids entering the housing of the device can cause a short-circuit and damage the electronics.

- ▶ Keep all liquids away from the radio microphone.

- ▶ Use a slightly damp cloth to clean the radio microphone from time to time. Do not use any solvents or cleansing agents.

To clean the sound inlet basket:

- ▶ Unscrew the upper sound inlet basket from the microphone head by turning it counterclockwise (see diagram).

**CAUTION!** Liquids will damage the microphone module!

Liquids will damage the microphone module.

- ▶ Only clean the upper sound inlet basket.

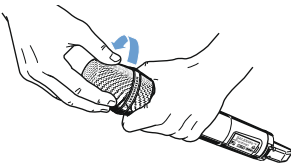

- ▶ Remove the foam insert.
- ▶ To clean the sound inlet basket:
  - Use a slightly damp cloth to clean the upper sound inlet basket from the inside and outside.
  - OR
  - Scrub with a brush and rinse with clear water.
- ▶ If necessary, clean the foam insert with a mild detergent or replace the foam insert.
- ▶ Dry the upper sound inlet basket.
- ▶ Dry the foam insert.
- ▶ Reinsert the foam insert.
- ▶ Replace the sound inlet basket on the microphone head and screw it tight.

You should also clean the contact rings of the microphone head from time to time:

- ▶ Wipe the contact rings of the microphone head with a dry cloth.

## If a problem occurs ...

Problem	Possible cause	Possible solution
Radio microphone cannot be operated, "Locked" appears on the display panel	Lock mode is activated	Deactivate the lock mode (siehe Seite 12).
No operation indication	Batteries are flat or accupack is flat	Replace the batteries or recharge the accupack (siehe Seite 9).
No RF signal at the receiver	Radio microphone and receiver are not on the same channel	Synchronize the radio microphone with the receiver.  Set the radio microphone to the same channel as the receiver.
	Radio microphone is out of range	Check the squelch threshold setting on the receiver.  Reduce the distance between radio microphone and receiving antenna.
	RF signal is deactivated ("RF Mute")	Activate the RF signal (siehe Seite 12).
RF signal available, no audio signal, "MUTE" appears on the display panel	Receiver's squelch threshold is adjusted too high	Reduce the squelch threshold setting on the receiver.
	Radio microphone doesn't transmit a pilot tone	Activate or deactivate the pilot tone transmission (siehe Seite 19).
Audio signal has a high level of background noise / audio signal is distorted	Radio microphone's sensitivity is adjusted too low/too high	Adjust the input sensitivity (siehe Seite 16).

If a problem occurs that is not listed in the above table or if the problem cannot be solved with the proposed solutions, please contact your local Sennheiser partner for assistance.

To find a Sennheiser partner in your country, search at [www.sennheiser.com](http://www.sennheiser.com) under "Service & Support".



# Specifications

## RF characteristics

Modulation	wideband FM
Frequency ranges	516–558, 566–608, 608–648, 626–668, 734–776, 780–822, 823–865 MHz (A to E, G, GB, siehe Seite 3)
Transmission frequencies	1,680 frequencies, tuneable in steps of 25 kHz
	20 frequency banks, each with up to 12 factory-preset channels
	1 frequency bank with up to 12 user programmable channels
Switching bandwidth	42 MHz
Nominal/peak deviation	± 24 kHz/± 48 kHz
Frequency stability	≤ ± 15 ppm
RF output power at 50 Ω	typ. 30 mW
Pilot tone squelch	can be switched off

## AF characteristics

Companion system	Sennheiser HDX
AF frequency response	80–18,000 Hz
Signal-to-noise ratio (1 mV, peak deviation)	≥ 110 dBA
THD	≤ 0.9 %
Adjustment range of input sensitivity	48 dB, adjustable in 6-dB steps

## Overall device

Temperature range	–10°C to +55°C
Power supply	2 AA size batteries, 1.5 V or BA 2015 accupack
Nominal voltage	2.4 V $\text{---}$
Power consumption	
at nominal voltage	typ. 180 mA (30 mW)
with switched-off radio microphone	≤ 25 µA
Operating time	typ. 8 hrs
Dimensions	approx. Ø 50 mm x 265 mm
Weight (incl. batteries)	approx. 450 g

## In compliance with

Europe



EMC	EN 301489-1/-9
Radio	EN 300422-1/-2
Safety	EN 60065, EN 62311 (SAR)

# Specifications

## Approved by

Canada

Industry Canada RSS 210  
IC: 2099A-G3SKMEM  
limited to 806 MHz

USA

FCC-Part 74  
FCC-ID: DMO G3SKMEM  
limited to 698 MHz

## Microphone heads

	MMD 835-1	MMD 845-1	MME 865-1
Microphone type	dynamic	dynamic	condenser
Sensitivity	2.1 mV/Pa	1.6 mV/Pa	1.6 mV/Pa
Pick-up pattern	cardioid	cardioid	super-cardioid
Max. SPL	154 dB SPL	154 dB SPL	152 dB SPL

## Polar diagrams and frequency response curves of the microphone heads

Polar diagram MMD 835-1

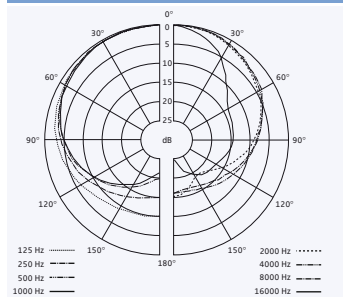

Polar diagram MMD 845-1

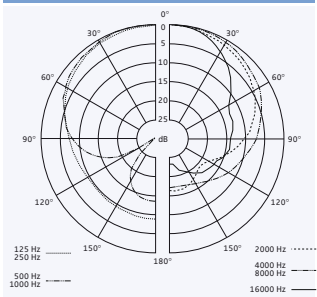

Polar diagram MME 865-1

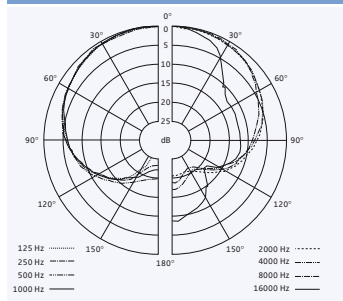

Frequency response curve MMD 835-1

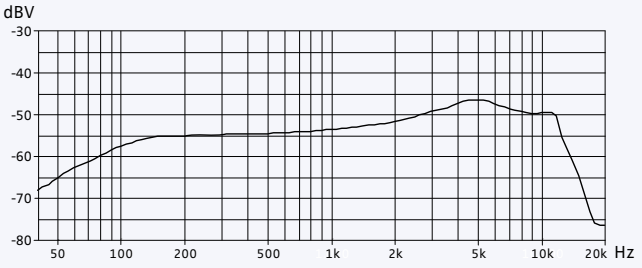

Frequency response curve MMD 845-1

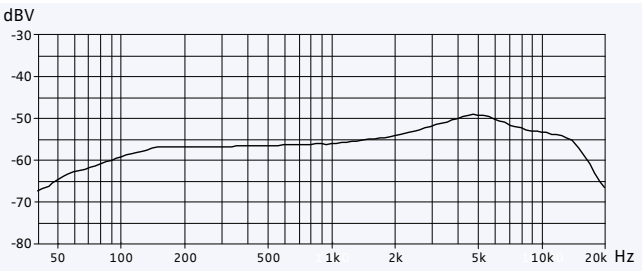

Frequency response curve MME 865-1

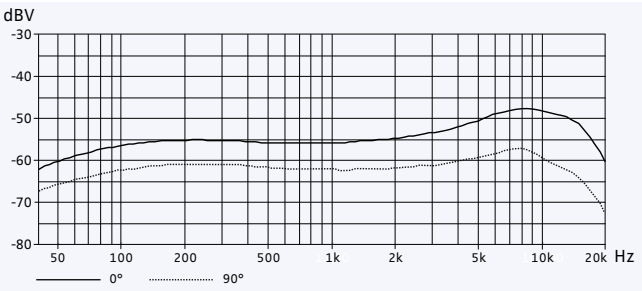

## Manufacturer Declarations

### Warranty

Sennheiser electronic GmbH & Co. KG gives a warranty of 24 months on this product.

For the current warranty conditions, please visit our web site at [www.sennheiser.com](http://www.sennheiser.com) or contact your Sennheiser partner.

### In compliance with the following requirements

- WEEE Directive (2012/19/EU)



Please dispose of the radio microphone at the end of its operational lifetime by taking it to your local collection point or recycling center for such equipment.

- Battery Directive (2006/66/EU)



The supplied batteries or rechargeable batteries of the radio microphone can be recycled. Please dispose of them as special waste or return them to your specialist dealer. In order to protect the environment, only dispose of exhausted batteries.

### CE Declaration of Conformity

- RoHS Directive (2011/65/EU)

• **CE 0682** 

- R&TTE Directive (1999/5/EU)
- EMC Directive (2014/30/EU)
- Low Voltage Directive (2014/35/EU)

The declarations are available at [www.sennheiser.com](http://www.sennheiser.com).

Before putting the device into operation, please observe the respective country-specific regulations.

### Statements regarding FCC and Industry Canada

This device complies with Part 15 of the FCC Rules and with RSS-210 of Industry Canada. Operation is subject to the following two conditions: (1) this device may not cause harmful interference, and (2) this device must accept any interference received, including interference that may cause undesired operation.

This equipment has been tested and found to comply with the limits for a Class B digital device, pursuant to Part 15 of the FCC Rules. These limits are designed to provide reasonable protection against harmful interference in a residential installation. This equipment generates, uses and can radiate radio frequency energy and, if not installed and used in accordance with the instructions, may cause harmful interference to radio communications. However, there is no guarantee that interference will not occur in a particular installation. If this equipment does cause harmful interference to radio or television reception, which can be determined by turning the equipment off and on, the user is encouraged to try to correct the interference by one or more of the following measures:

- Reorient or relocate the receiving antenna.
- Increase the separation between the equipment and receiver.
- Connect the equipment into an outlet on a circuit different from that to which the receiver is connected.
- Consult the dealer or an experienced radio/TV technician for help.

This class B digital device complies with the Canadian ICES-003.

Changes or modifications made to this equipment not expressly approved by Sennheiser electronic Corp. may void the FCC authorization to operate this equipment.

Before putting the device into operation, please observe the respective country-specific regulations!

### FOR AUSTRALIA ONLY

Sennheiser goods come with guarantees that cannot be excluded under the Australian Consumer Law. You are entitled to a replacement or refund for a major failure and compensation for any other reasonably foreseeable loss or damage. You are also entitled to have the goods repaired or replaced if the goods fail to be of acceptable quality and the failure does not amount to a major failure.

This warranty is in addition to other rights or remedies under law. Nothing in this warranty excludes, limits or modifies any liability of Sennheiser which is imposed by law, or limits or modifies any remedy available to the consumer which is granted by law.

To make a claim under this warranty, contact

Sennheiser Australia Pty Ltd, Unit 3, 31 Gibbes Street Chatswood NSW 2067, AUSTRALIA.

Phone: (02) 9910 6700, email: [service@sennheiser.com.au](mailto:service@sennheiser.com.au).

All expenses of claiming the warranty will be borne by the person making the claim.

The Sennheiser International Warranty is provided by Sennheiser Australia Pty Ltd (ABN 68 165 388 312), Unit 3, 31 Gibbes Street Chatswood NSW 2067 Australia.

Sennheiser electronic GmbH & Co. KG  
Am Labor 1, 30900 Wedemark, Germany  
[www.sennheiser.com](http://www.sennheiser.com)

Publ. 04/16  
529671/A03