









AVX

System Manual



Contents

	Important safety information	2
	AVX – perfect sound you can rely on	5
	Package contents	6
	Product overviews	7
	EKP AVX receiver	7
	SKM AVX, SKM AVX-S and SK AVX transmitters	9
	USB power supply/charger	12
	ME 2 clip-on microphone	12
	MKE 2 clip-on microphone	12
	Putting the products into operation	13
	Putting the receiver into operation	14
	Putting the bodypack transmitter into operation	15
	Putting the clip-on microphones into operation	16
	Putting the handheld transmitter into operation	20
	Recharging the accupack	21
	Using the products	23
	Switching the devices on or off	23
	Checking the charge status of the accupacks	24
	Checking the RF signal level	25
	Muting the bodypack transmitter or the SKM AVX-S handheld transmitter	25
	Pairing a receiver with a transmitter	26
	Identifying paired devices	26
	Displaying or adjusting the receiver's audio output level	27
	Cleaning and maintaining the products	28
	If a problem occurs	29
	Specifications	30
	Licenses	34
	Accessories	36
	Manufacturer Declarations	37



Important safety information



1. Read these safety instructions and the instruction manuals of the products.
2. Keep these safety instructions and the instruction manuals of the products. Always include these safety instructions and the instruction manuals when passing the products on to third parties.
3. Heed all warnings.
4. Follow all instructions.
5. Do not use the products near water.
6. Do not operate near any heat sources such as radiators, stoves, or other apparatus (including amplifiers) that produce heat.
7. Only operate the products from the types of power source specified in the chapter "Specifications" on page 30 and indicated on the power supply unit.
8. Unplug the power supply units from the wall socket,
 - to completely disconnect the products from the power supply system,
 - during lightning storms or
 - when not using the products for long periods of time.
9. Always ensure that the power supply units are
 - in a safe operating condition and easily accessible,
 - properly plugged into the wall socket,
 - only operated within the permissible temperature range,
 - not covered or exposed to direct sunlight for longer periods of time in order to prevent heat accumulation.
10. Protect the power cords from being walked on or pinched, particularly at the points where they exit from wall sockets, power supply units and products.
11. Only use attachments, accessories or spare parts specified by Sennheiser
12. Refer all servicing to qualified service personnel. Servicing is required when the products have been damaged in any way, liquid has been spilled or objects have fallen into the products, when the products has been exposed to rain or moisture, do not operate normally, or have been dropped.
13. **WARNING:** To reduce the risk of fire or electric shock, do not expose the products to rain or moisture.
14. Do not expose the products to dripping or splashing. Ensure that no objects filled with liquids, such as vases, are placed on the products.





Safety instructions for lithium-ion rechargeable batteries



If abused or misused, the rechargeable batteries may leak. In extreme cases, they may even present a risk of

- explosion,
- fire development,
- heat generation,
- smoke or gas development.

Sennheiser does not accept any liability for damage arising from abuse or misuse.



▶ Keep away from children.



▶ Only charge rechargeable batteries with chargers recommended by Sennheiser.



▶ Observe correct polarity.



▶ Pack/store charged rechargeable batteries so that the terminals cannot contact each other – danger of shorting out/fire hazard.



▶ Do not expose to moisture.



▶ Switch rechargeable battery-powered products off after use.



▶ Only charge rechargeable batteries at ambient temperatures between 10 °C/50 °F and 40 °C/104 °F.



▶ When not using rechargeable batteries for extended periods of time, charge them regularly (about every three months).



▶ Do not mutilate or dismantle.



▶ Do not heat above 60 °C/140 °F, e.g. do not expose to sunlight or throw into a fire.



▶ Immediately remove rechargeable batteries from obviously defective products.



▶ Do not continue to use defective rechargeable batteries.



▶ Only use rechargeable batteries specified by Sennheiser.



▶ Dispose of rechargeable batteries at special collection points or return them to your specialist dealer.



▶ Store the products in a cool and dry place at room temperature (approx. 20 °C/68 °F).



▶ Remove the rechargeable batteries if the products will not be used for extended periods of time.



Intended use

The microphones, the transmitters, the receiver and the accessories of the Sennheiser AVX system can be combined with each other and have been designed for use in video recordings in dry environments.

In order that speech, music and vocals are transmitted in the best possible quality, the receiver has to be connected, as described in this instruction manual, to a video camera or a DSLR camera with video recording function.

The products can be used for commercial purposes.

Intended use includes:

- having read and understood these safety instructions and the instruction manuals of the products
- using the products within the operating conditions and limitations described in these safety instructions and in the instruction manuals of the products.

It is considered improper use when the products are used for any application not named in the instruction manuals of the products.

Sennheiser does not accept liability for damage arising from abuse or misuse of the products and their accessories.



AVX – perfect sound you can rely on

AVX is the wireless digital microphone system for your film projects and is ideal for use with both video and DSLR cameras.

AVX features self-configuring digital transmission which eliminates time-consuming frequency setup. The ultra compact receiver can be rotated freely around its XLR connector to avoid obstructing other devices mounted on your camera. It switches on and off automatically with your camera, thereby saving battery power. AVX matches perfectly to your camera's input sensitivity without having to adjust the audio level on the microphone. From professional wedding video to documentaries, from street interviews to corporate videos, AVX just works allowing you to concentrate on creativity.

- Very fast setup
- Receiver plugs directly into the XLR audio input of the camera
- Ultra compact receiver
- Receiver switches on and off with the camera's P48 phantom power
- Optimized dynamic range
- Automatic frequency management
- AES 256 encryption
- License-free 1.9 GHz frequency range
- DSLR accessories included
- Metal housing
- Made in Germany



Package contents

Package contents	Lavalier Set	Lavalier Set Pro	Handheld Set	Combo Set ¹
	AVX-ME 2	AVX-MKE 2	AVX-835	AVX-MMD 42-1
EKP AVX receiver	1	1	1	1
SK AVX bodypack transmitter	1	1	–	1
ME 2 clip-on microphone	1	–	–	1
MKE 2 clip-on microphone	–	1	–	–
SKM AVX-S handheld transmitter with mute switch incl. MMD 835-1 microphone head (cardioid)	–	–	1	–
SKM AVX handheld transmitter without mute switch incl. MMD 42-1 microphone head (omni-directional)	–	–	–	1
BA 10 accupack	–	–	1	1
BA 20 accupack	1	1	1	1
BA 30 accupack	1	1	–	1
EKP AVX adapter	1	1	1	1
NT 5-10U power supply unit	1	1	1	1
CI 400 adapter cable	1	1	1	1
Microphone stand clamp for handheld transmitter	–	–	1	1
Bag	1	1	1	1

¹ only available in the USA



Product overviews

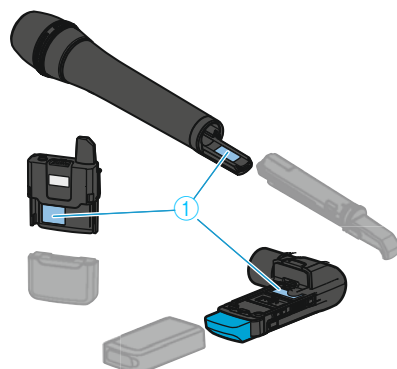

The transmitters and the receiver are available in different country variants:

- Country variant -3 for Europe, the Mid East and Australia
- Country variant -4 for North, Central and South America (except Brazil)
- Country variant -5 for Japan
- Country variant -6 for Taiwan
- Country variant -7 for Brazil

The country variant can be found on the packaging and on the type plate ① as shown on the left.

- ▶ Only use the country variant permitted for use at the venue.
- ▶ Do not combine devices of different country variants.

EKP AVX receiver

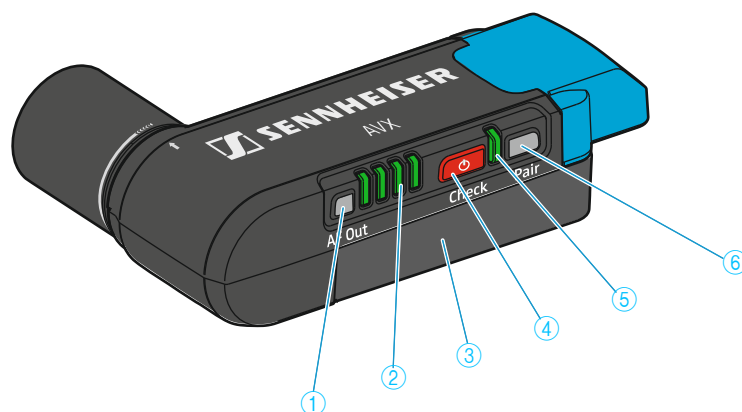

- ① AF Out button
- ② 4-step LED display



- ③ BA 20 accupack
- ④ On/Off/Check button

for displaying and adjusting the audio output level (see page 27)



When the **On/Off/Check** button has been pressed, the LED display lights up green to indicate the remaining battery life of the receiver's BA 20 accupack (see page 24); when the **AF Out** button has been pressed, the LED display lights up red to indicate the audio output level (see page 27).

When the right LED flashes red, the capacity of the receiver's BA 20 accupack is only sufficient for a maximum of 15 minutes of operation.

For details, see page 8.

Short-press to switch the receiver on (see page 23) or to display the charge status of the accupack (see page 24);
Long-press to switch the receiver off (see page 23).



- ⑤ Status LED
 - * lights up green: A radio link to the transmitter is established. The accupack of the received transmitter is sufficiently charged.
 -  flashes green: The **Pair** button has been short-pressed. The paired transmitter is being identified.
 -  flashes alternately green and red: The **Pair** button has been long-pressed. The receiver establishes a radio link to a transmitter whose **Pair** button has also been long-pressed.
 - * lights up yellow: The received transmitter has been muted with its **MUTE** switch.
 -  flashes red: The accupack capacity of the received transmitter is only sufficient for approx. 15 minutes of operation.
 - * lights up red: No radio link to a transmitter.

⑥ **Pair** button
 Short-press to identify the paired transmitter (see page 26).
 Long-press to change the pairing (see page 26).

⑦ Rotatable XLR-3 connector
 for connection to the video camera or the DSLR camera
 The receiver can be rotated by a maximum angle of 320°.



⑧ EKP AVX adapter
 The EKP AVX adapter consists of a hot shoe adapter and a belt clip. The belt clip allows the attachment of the receiver to a belt or a pocket (see page 15). The hot shoe adapter allows the attachment of the receiver to the hot shoe of a DSLR camera. The receiver can then be connected to the DSLR camera using the CI 400 adapter cable (see page 14).

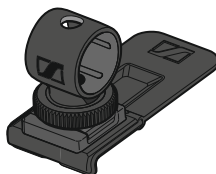

BA 20 accupack for the EKP AVX receiver

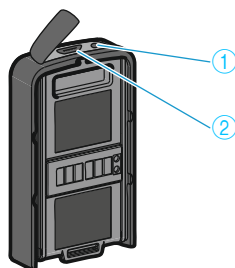

- ① Charge status LED
 - * lights up green: The accupack is fully charged.
 - * lights up red: The accupack is being charged.
- ② Micro USB socket for charging the accupack (see page 21)



SKM AVX, SKM AVX-S and SK AVX transmitters

SKM AVX and SKM AVX-S handheld transmitters

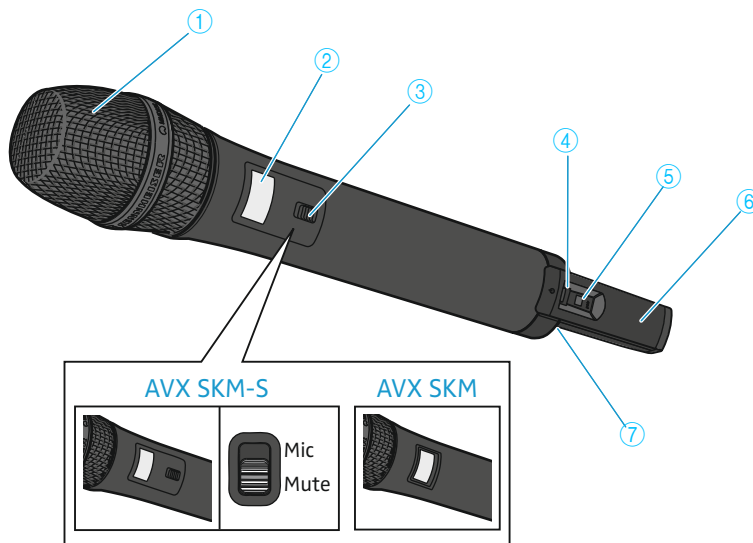

① Unscrewable microphone head

For details, see page 21.

② Display panel

For details, see page 11.

③ MUTE switch

for muting the SKM AVX-S handheld transmitter (for details, see page 25)

④ ON/OFF button with status LED

Slide briefly to switch the handheld transmitter on.
Slide and hold to switch the handheld transmitter off (for details, see page 24).

* lights up green: A radio link to the receiver is established. The accupack of the handheld transmitter is sufficiently charged.

* * * * |... flashes green: The Pair button has been short-pressed. Paired devices are being identified.

* * * * |... flashes alternately green and red: The Pair button has been long-pressed. The handheld transmitter establishes a radio link to a receiver whose Pair button has also been long-pressed.

* lights up yellow: The SKM AVX-S handheld transmitter has been muted with the MUTE switch. In addition, **Muted** is displayed on the display panel.

* * * * |... flashes red: The accupack capacity of the received transmitter is only sufficient for approx. 15 minutes of operation.

* lights up red: No radio link to a receiver. In addition, **No Link** is displayed on the display panel.

⑤ Pair button

Short-press to identify the paired receiver (see page 26).
Long-press to change the pairing (see page 26).

⑥ Antenna

i Do not cover the antenna during transmission to avoid a reduction in the transmission range.

⑦ BA 10 accupack

For details, see page 10.



BA 10 accupack for the SKM AVX or SKM AVX-S handheld transmitter

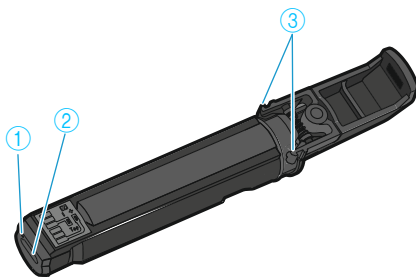

- ① Charge status LED
 - * lights up green: The accupack is fully charged.
 - * lights up red: The accupack is being charged.
- ② Micro USB socket for charging the accupack (see page 21)
- ③ Catches Press simultaneously to release the accupack from the handheld transmitter.

Microphone stand clamp for the handheld transmitters

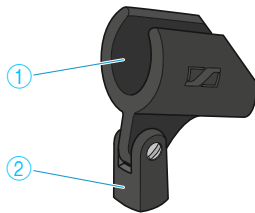

- ① Microphone clamp for attachment of the handheld transmitter
- ② Thread for screwing the microphone clamp onto a stand

SK AVX bodypack transmitter

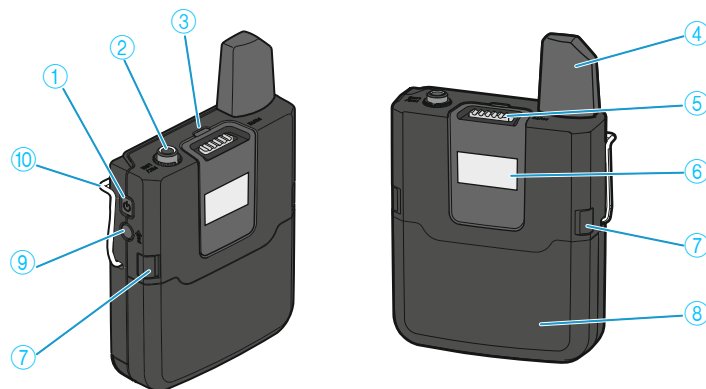

- ① On/Off button Short-press to switch the bodypack transmitter on. Long-press to switch the bodypack transmitter off (for details, see page 24).
- ② Mic/Line 3.5 mm jack socket for connecting the clip-on microphone
- ③ Status LED
 - * lights up green: A radio link to the receiver is established. The accupack of the bodypack transmitter is sufficiently charged.
 - * lights up green: The Pair button has been short-pressed. Paired devices are being identified (for details, see page 26).
 - * lights up red: The Pair button has been long-pressed. The bodypack transmitter establishes a radio link to a receiver whose Pair button has also been long-pressed (for details, see page 26).
 - * lights up yellow: The bodypack transmitter has been muted with its MUTE switch. In addition, Muted is displayed on the display panel (for details, see page 25).
 - * lights up red: The accupack capacity of the bodypack transmitter is only sufficient for approx. 15 minutes of operation.
 - * lights up red: No radio link to a receiver. In addition, No Link is displayed on the display panel.
- ④ Antenna
 - Do not cover the antenna during transmission to avoid a reduction in the transmission range.



- ⑤ MUTE switch
- ⑥ Display panel
- ⑦ Catches
- ⑧ BA 30 accupack
- ⑨ Pair button
- ⑩ Belt clip

for muting the bodypack transmitter (for details, see page 25)

For details, see page 11.

Press simultaneously to release the accupack from the bodypack transmitter.

For details, see page 11.

Short-press to identify the paired receiver (see page 26).

Long-press to change the pairing (see page 26).

For details, see page 15.

BA 30 accupack for the SK AVX bodypack transmitter

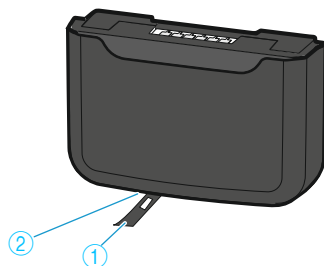

① USB cover flap Covers the micro USB socket for charging the accupack (see page 21).

② Charge status LED ✱ lights up green: The accupack is fully charged.

✱ lights up red: The accupack is being charged.

Displays of the transmitters

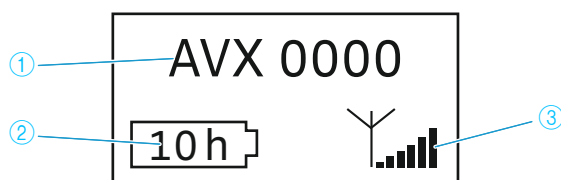

① Name of the radio link

The name of the radio link always consists of "AVX" and the last four digits of the serial number of the paired receiver. The receiver's serial number can be found on the type plate under the accupack.

You cannot change this name.

② Expected battery life of the accupack

For details, see page 24.

③ 6-segment RF signal level display

Displays the field strength of the transmitted signal at the receiver.



USB power supply/charger

The NT 5-10U power supply/charger is suitable for recharging the BA 10 accu-pack (handheld transmitter), the BA 20 accupack (receiver) or the BA 30 accupack (bodypack transmitter).

i You can recharge the BA 10, BA 20 and BA 30 accupacks as follows:

- using the Sennheiser NT 5-10U USB power supply/charger
- using any USB power supply/charger
- via the USB port of a computer
- via a USB hub with its own power supply
- via a mobile USB power supply (power bank)

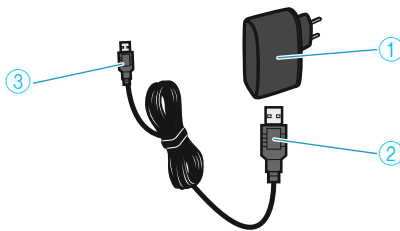

- | | |
|--------------------------|--|
| ① NT 5-10U | USB power supply/charger (country-specific) for charging the accupacks |
| ② USB connector (type A) | for connection to the USB power supply/charger |
| ③ Micro USB connector | for connection to an accupack |

ME 2 clip-on microphone

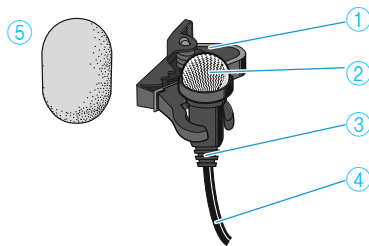

- | | |
|----------------------------|---|
| ① Microphone clip | for attaching the clip-on microphone to clothing |
| ② Microphone capsule | with omni-directional pick-up pattern |
| ③ Anti-kink protection | to prevent cable damage |
| ④ Connection cable (1.6 m) | with lockable 3.5 mm jack plug for connection to the bodypack transmitter |
| ⑤ Foam windshield | for attenuating wind noise by 10 dB |

MKE 2 clip-on microphone

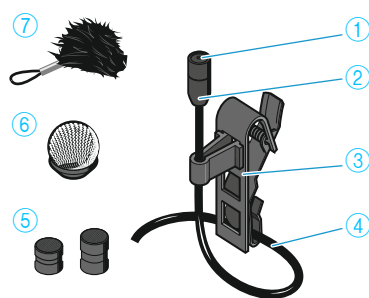

- | | |
|----------------------------|---|
| ① Microphone capsule | with omni-directional pick-up pattern |
| ② Anti-kink protection | to prevent cable damage |
| ③ Microphone clip | for attaching the clip-on microphone to clothing |
| ④ Connection cable (1.6 m) | with lockable 3.5 mm jack plug for connection to the bodypack transmitter |
| ⑤ Frequency response caps | for sound optimization |
| ⑥ Metal windshield | for attenuating wind noise by 20 dB |
| ⑦ Fur windshield | for attenuating wind noise by additional 10 dB; with retaining loop for secure attachment to the clip-on microphone |



Putting the products into operation

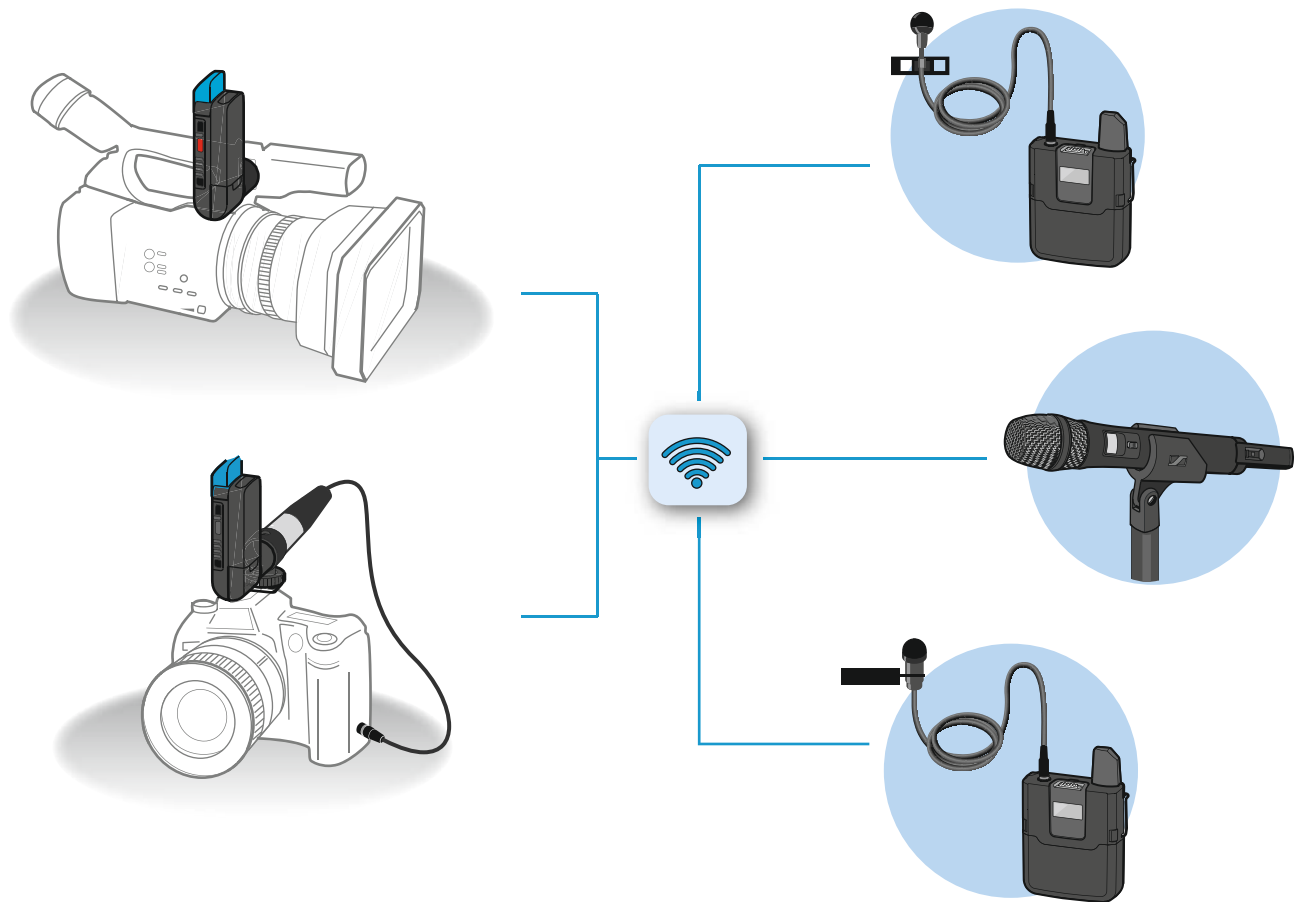

Avoiding sources of interference

Featuring automatic interference management, the devices are capable of avoiding interfering signals at any time by automatically moving together to unused frequencies in the 1.9 GHz frequency band, without any audio interruption. However, the number of usable radio links is reduced if there are active sources of interference in the vicinity of the devices.

- ▶ Maintain a distance to sources of interference in the 1.9 GHz frequency band.

Possible sources of interference are e.g. base stations of DECT telephones.

WiFi, Bluetooth, Sennheiser ew D1, infrared remote controls and headphones as well as UHF radio links such as Sennheiser evolution wireless G3 **do not represent sources of interference**. You do not have to maintain a distance to such equipment.

Direct line of sight

Walls and other obstacles will reduce the range. Therefore, there should always be a direct line of sight between the transmitting antenna and the receiving antenna of a radio link.



Putting the receiver into operation

The receiver can be rotated by a maximum angle of 320° around its XLR-3 connector.

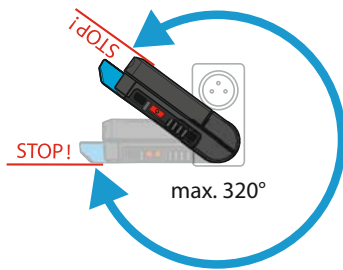

Mounting the receiver to a video camera

To mount the receiver to a video camera, proceed as follows:

- ▶ Plug the receiver's rotatable XLR connector into the camera's XLR-3 audio input.

If the video camera has an XLR-3 audio input with P48 phantom power, the receiver is automatically switched on and off together with the video camera – provided that the phantom power is automatically switched on and off together with the camera.
- ▶ Rotate the receiver into position, making sure that it does not disturb during filming and that there is – preferably – a direct line of sight to the transmitter.

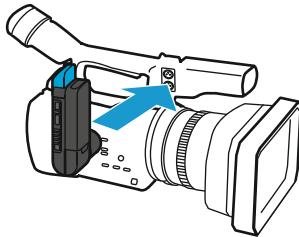

Mounting the receiver to a digital single-lens reflex camera

To mount the receiver to a DSLR camera, use the supplied EKP AVX adapter. The adapter consists of a hot shoe adapter and a belt clip.

- ▶ Loosen the locking screw.
- ▶ Remove the hot shoe adapter from the belt clip.
- ▶ Slide the hot shoe adapter onto the hot shoe of the DSLR camera as shown on the left.
- ▶ Fasten the hot shoe adapter using the locking screw .

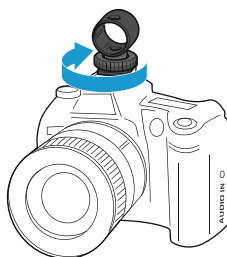
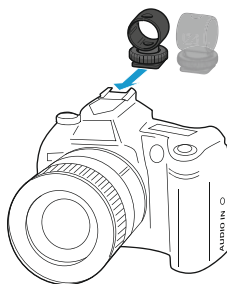
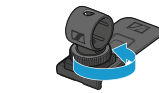

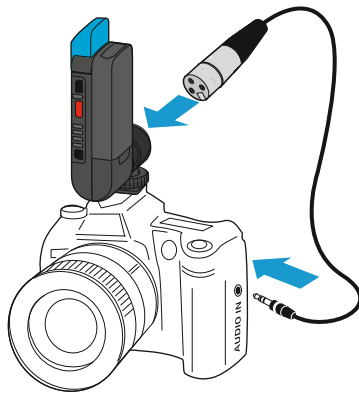

- ▶ Plug the receiver's rotatable XLR connector into the hot shoe adapter.
- ▶ Connect the XLR-3 socket of the supplied CI 400 adapter cable to the XLR-3 connector of the receiver.
- ▶ Connect the 3.5 mm jack plug of the CI 400 adapter cable to the 3.5 mm audio input of the DSLR camera.

Attaching the receiver using the belt clip

You can use the belt clip to attach the receiver to e.g. a belt or to the camera bag.

Proceed as follows:

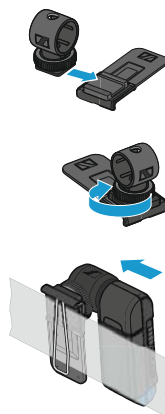

- ▶ Slide the hot shoe adapter onto the belt clip.
- ▶ Fasten the hot shoe adapter to the belt clip using the locking screw.
- ▶ Plug the receiver's rotatable XLR-3 connector into the hot shoe adapter as shown on the left.
- ▶ Use the belt clip to attach the receiver to a camera bag or a belt.

Putting the bodypack transmitter into operation

Removing/inserting the accupack

You can power the bodypack transmitter with the supplied BA 30 accupack. The accupack must be charged before first time use. The accupack can remain in the bodypack transmitter for charging.

i Before using the bodypack transmitter for the first time, remove the protective foil from its accupack.

To remove the accupack from the bodypack transmitter:

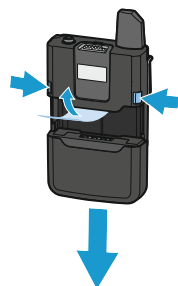

- ▶ Simultaneously press the two catches and pull the accupack away from the bodypack transmitter.
- ▶ Remove the protective foil.

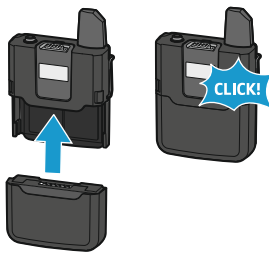

To insert the accupack into the bodypack transmitter:

- ▶ Slide the accupack onto the bodypack transmitter as shown. The accupack locks into place with an audible click.

Attaching the bodypack transmitter to clothing

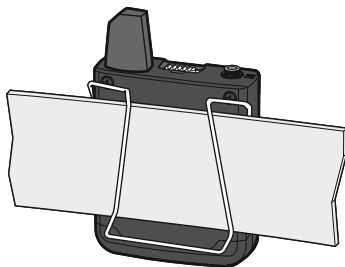

- ▶ Use the belt clip to attach the bodypack transmitter to clothing.
 - The antenna of the bodypack transmitter should not be touched or covered during transmission as this would reduce the transmission range.
 - There should be a free line of sight between the antenna of the bodypack transmitter and the receiving antenna.

Connecting a clip-on microphone to the bodypack transmitter

Only connect one of the clip-on microphones recommended by Sennheiser. These microphones are optimized for the bodypack transmitter.

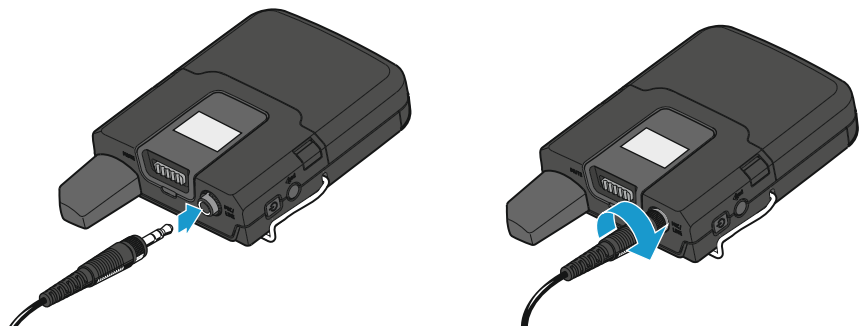

- ▶ Connect the jack plug of the clip-on microphone to the 3.5 mm jack socket (Mic/Line) of the bodypack transmitter.
- ▶ Lock the jack plug by screwing down the coupling ring.

Putting the clip-on microphones into operation

Putting the MKE 2 into operation

The MKE 2 clip-on microphone is supplied with the Lavalier Set Pro and meets the highest demands on sound quality and ruggedness.

Using the frequency response caps

You can use the supplied frequency response caps to boost the frequency response of the MKE 2 (e.g. if the sound is too muffled) and to optimize your recordings by improving the speech intelligibility.

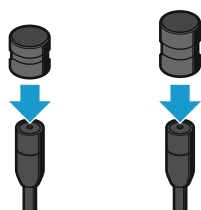

- ▶ Slip the frequency response cap of your choice onto the microphone capsule until it locks into place.
 - The (small) MZC 2-1 frequency response cap slightly increases the treble response of the microphone.
 - The (large) MZC 2-2 frequency response cap allows you to increase the treble frequencies to a greater extent.



Using the windshield

In order to avoid annoying wind noise during recording, we recommend using a suitable windshield.

The MKE 2 is supplied with a metal windshield and a fur windshield. To begin with, use the metal windshield which reduces wind noise by up to 20 dB. With the additional fur windshield, you can reduce wind noise by a further 10 dB.

The fur windshield can only be used together with the metal windshield.

To use the metal windshield:

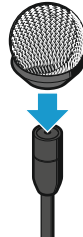

- ▶ Slip the metal windshield onto the microphone capsule of the MKE 2. The microphone is ready for operation and can be attached to clothing by means of the supplied microphone clip (see page 18).

To use the fur windshield:

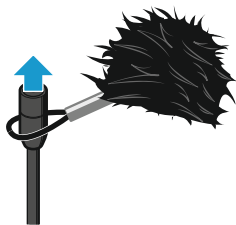

- ▶ If you are already using the metal windshield or one of the frequency response caps, remove them from the microphone capsule.
- ▶ Stretch open the retaining loop of the fur windshield by moving the sleeve towards the fur.

Make sure you do not accidentally remove the sleeve from the retaining loop.



- ▶ Pass the microphone through the retaining loop of the fur windshield. The retaining loop now fits loosely around the connection cable of the MKE 2.

- ▶ Slip the metal windshield onto the microphone capsule.



- ▶ Carefully stretch the opening of the fur windshield and slide it over the metal windshield. Make sure that the fur windshield completely covers the metal windshield.



- ▶ Use the sleeve to tighten the retaining loop around the connection cable. The retaining loop ensures that the fur windshield is securely attached to the clip-on microphones.



Attaching the clip-on microphone to clothing

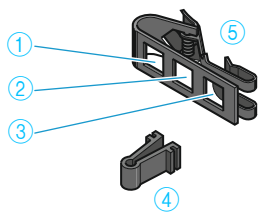

The MKE 2 is supplied with a microphone clip that consists of two parts:

- a microphone holder ④
- a clip ⑤ for attaching the microphone to clothing

The clip has three holes. Inserting the microphone holder into one of the holes influences the clip's contact pressure and thus ensures secure attachment of the clip to clothing made of different materials:

- Hole ①: for attaching the microphone clip to clothing made of very heavy and tightly-woven materials
- Hole ②: for attaching the microphone clip to clothing made of medium-heavy materials
- Hole ③: for attaching the microphone clip to clothing made of very thin materials

▶ Snap the connection cable of the MKE 2 into the microphone holder.

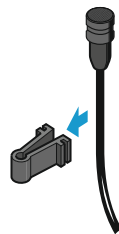

▶ Insert the microphone holder into the desired hole of the microphone clip. To do so, press the two ends of the microphone holder together and hook it into the hole.

The microphone clip can be attached to clothing either vertically or horizontally. Make sure to insert the microphone holder into the hole according to the desired orientation of the microphone clip.

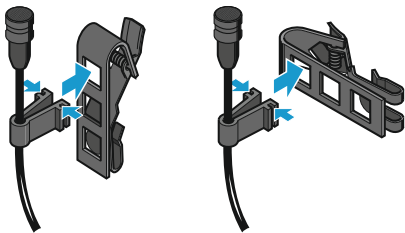

To vertically attach the microphone clip to clothing:

▶ Guide the connection cable through the cable grip of the clip.

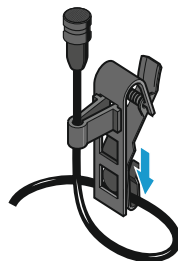

▶ Use the microphone clip to attach the clip-on microphone to clothing (e.g. lapel, collar, tie).

▶ Conduct the connection cable so that noise due to friction is avoided and that the connection cable and the antenna do not cross.

▶ Attach the microphone at a distance of approx. 25 cm to the mouth.

The MKE 2 clip-on microphone has an omni-directional pick-up pattern. It is therefore not necessary to position it precisely.

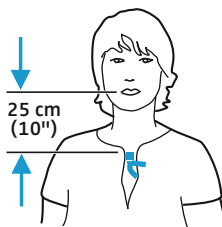



Putting the ME 2 into operation

The ME 2 clip-on microphone is supplied with the Lavalier Set and provides professional recordings with a high degree of speech intelligibility.

Using the windshield

In order to avoid annoying wind noise during recording, we recommend using a suitable windshield.

The ME 2 is supplied with a foam windshield which reduces wind noise by up to 10 dB.

To use the foam windshield:

- ▶ Slip the foam windshield onto the metal windshield of the ME 2.

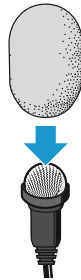

Attaching the ME 2 to clothing

The ME 2 clip-on microphone is supplied with a microphone clip.

- ▶ Snap the microphone into the holder of the microphone clip. The microphone clip can be attached to clothing either vertically or horizontally. To do so, turn the holder so that the microphone is correctly positioned.

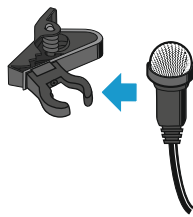

- ▶ Use the microphone clip to attach the clip-on microphone to clothing (e.g. lapel, collar, tie).
- ▶ Conduct the connection cable so that noise due to friction is avoided and that the connection cable and the antenna do not cross.
- ▶ Attach the microphone at a distance of approx. 25 cm to the mouth.

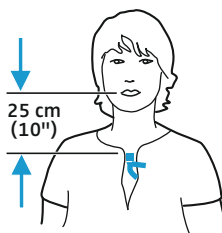

The ME 2 clip-on microphone has an omni-directional pick-up pattern. It is therefore not necessary to position it precisely.



Putting the handheld transmitter into operation

The handheld transmitter is available both with and without **Mute** switch and comes with different microphone heads.

i Before using the handheld transmitter for the first time, remove the protective foil from its accupack.

Removing/inserting the accupack

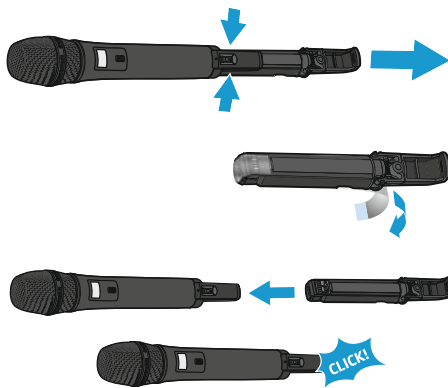

To remove the accupack:

- ▶ Simultaneously press the two catches and pull the accupack away from the handheld transmitter.
- ▶ Remove the protective foil.

To insert the accupack:

- ▶ Slide the accupack onto the handheld transmitter as shown. The accupack locks into place with an audible click.

Holding the handheld transmitter

If you cover the antenna of the handheld transmitter during transmission, the transmission range will be considerably reduced. If you cover the microphone head during transmission, this will change the pick-up pattern of the microphone and consequently the sound.

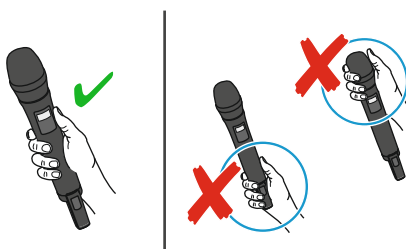

- ▶ Only hold the handheld transmitter by its body.
- ▶ Hold the handheld transmitter approx. 5 to 10 cm in front of your mouth.

The MMD 835-1 microphone head has a cardioid pick-up pattern:

- ▶ You can speak into the sound inlet basket from directly above or from slightly off-axis.

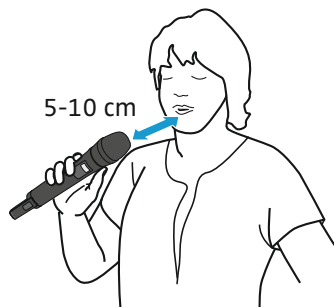

The MMD 42-1 microphone head has an omni-directional pick-up pattern:

- ▶ It is not necessary to orient the microphone directly towards the mouth. The microphone can also be used by several people simultaneously.



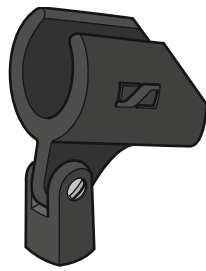

Attaching the handheld transmitter to the microphone stand clamp

- ▶ Screw the thread to the stand and tighten the screw.
- ▶ Place the handheld transmitter into the microphone clamp.
- ▶ Tilt the handheld transmitter so that it is oriented towards the mouth.

Changing the microphone head

The handheld transmitter comes in different sets, including either the MMD 835-1 or the MMD 42-1 microphone head. You can unscrew the microphone head and replace it by another one, e.g. one with a different pick-up pattern.

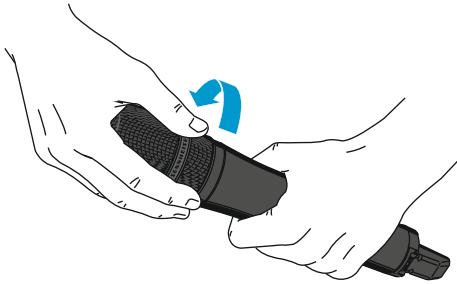

Recharging the accupack

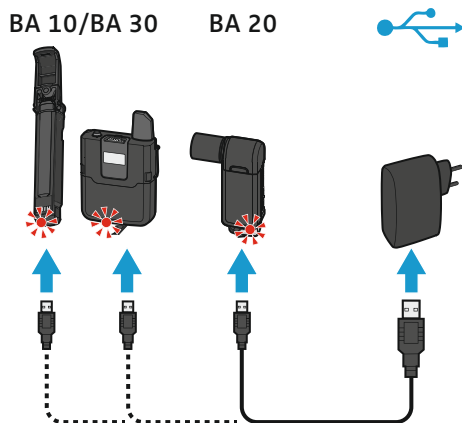

i You can recharge the supplied BA 10, BA 20 and BA 30 accupacks as follows:

- using the Sennheiser NT 5-10U USB power supply/charger
- using a standard USB power supply/charger
- via the USB port of a computer
- via a USB hub with its own power supply
- via a mobile USB power supply (power bank)

Charging the accupacks using the NT 5-10U power supply/charger

The BA 20 accupack of the receiver and the BA 30 accupack of the bodypack transmitter can remain in their respective devices for charging. To charge the BA 10 accupack of the handheld transmitter:

- ▶ Remove the accupack from the handheld transmitter (see page 15).
- ▶ If the accupack's micro USB socket has a cover flap: Open the cover flap of the micro USB socket of the accupack and connect the micro USB connector of the USB cable to the micro USB socket of the accupack.

To charge the accupack via the USB port of a computer or a mobile USB power supply (power bank):

- ▶ Connect the USB connector of the USB cable to a USB socket of the computer or the mobile USB power supply.
- ▶ Switch the computer or the mobile USB power supply on.



To charge the accupack using any USB power supply/charger or a USB hub with external power supply:

- ▶ Connect the USB connector of the USB cable to the USB socket of the USB power supply/charger or to the USB hub.
- ▶ Plug the USB power supply/charger or the power supply unit of the USB hub into the wall socket.

The charge status LED of the accupack lights up red when the accupack is being charged. The charge status LED of the accupack lights up green when the accupack is fully charged.

Accupack	Charging time required for a capacity of ...			
	... 30 %	... 60 %	... 75 %	... 100 %
BA 10 (handheld transmitter)	1:00 h	2:00 h	3:00 h	4:30 h
BA 20 (receiver)	0:15 h	0:30 h	0:40 h	1:15 h
BA 30 (bodypack transmitter)	1:00 h	2:00 h	3:00 h	4:30 h



Using the products

AVX offers true ease of use:

- The devices of a set are factory pre-paired and ready for immediate use.
- The system features automatic frequency management and automatically searches for free transmission frequencies.
- AVX also features automatic interference management and inaudibly shifts to a new frequency if interference occurs.
- The system also sets the correct microphone sensitivity automatically.
- Sound that is too loud or, even worse, too quiet is now a thing of the past.

Switching the devices on or off

i After switch-on, the receiver and the transmitter will take approx. 10 seconds to establish the radio link. The more sources of interference there are and the more AVX devices you switch on, the longer it takes to establish the radio links.

Switching the receiver on

i If the receiver is connected to an XLR-3 audio input with P48 phantom power, the receiver is automatically switched on together with the video camera – provided that the phantom power is automatically switched on together with the camera.

To manually switch the receiver on:

- ▶ Short-press the **On/Off/Check** button.
The status LED indicates the current status of the receiver (see page 7). The radio link to the last paired transmitter is established automatically as soon as the paired transmitter is switched on.

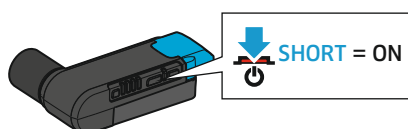

Switching the receiver off

i If the receiver is connected to an XLR-3 audio input with P48 phantom power, the receiver is automatically switched off together with the video camera – provided that the phantom power is automatically switched off together with the camera. If, after switch-off of the video camera, the phantom power drops only slowly, the receiver can take up to one minute to switch off.

To manually switch the receiver off:

- ▶ Long-press the **On/Off/Check** button.
The status LED goes off.

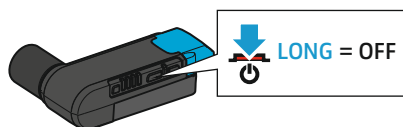

Switching the bodypack transmitter on

- ▶ Short-press the **On/Off** button.
The display panel and the status LED indicate the current status of the bodypack transmitter (see page 10 and page 11). The radio link to the last paired receiver is automatically established as soon as the paired receiver is switched on.

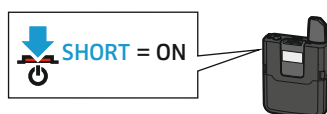



Switching the bodypack transmitter off

- ▶ Long-press the **On/Off** button.
The display panel and the status LED go off.

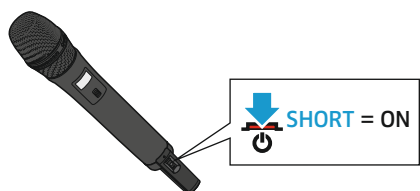

Switching the handheld transmitter on

- ▶ Briefly slide the **On/Off** button in the direction of the transmitter body.

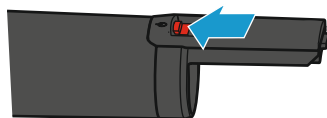

The display panel and the status LED indicate the current status of the handheld transmitter (see page 9 and page 11). The radio link to the last paired receiver is automatically established as soon as the paired receiver is switched on.

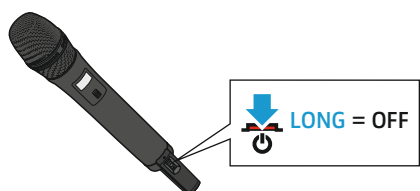

Switching the handheld transmitter off

- ▶ Slide and hold the **On/Off** button in the direction of the transmitter body.

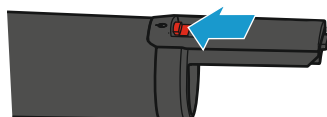

The display panel and the status LED go off.

Checking the charge status of the accupacks

Checking the charge status of the BA 20 accupack in the receiver

To display the expected remaining battery life of the BA 20 accupack in the receiver:

- ▶ Short-press the **On/Off/Check** button.
The 4-step LED display lights up green to indicate the expected remaining battery life.

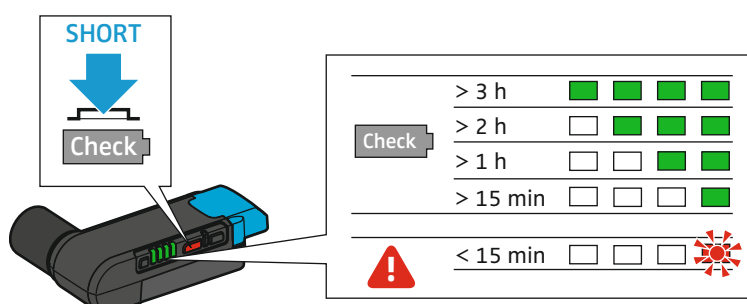

When the right LED of the 4-step LED display flashes red – regardless of whether the **On/Off/Check** button has been pressed –, the capacity of the BA 20 accupack is only sufficient for less than 15 minutes of operation.



Checking the charge status of the BA 10 accupack in the handheld transmitter or of the BA 30 accupack in the bodypack transmitter

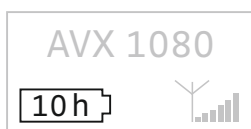

The expected remaining battery life of the accupack is indicated by a battery icon on the transmitter display panel.

When the capacity of the accupack is so low that the remaining battery life is less than 30 minutes, the status LED on both the transmitter and the receiver flashes red.

In addition, the empty battery icon flashes on the display panel of the transmitter.

Checking the RF signal level



The quality of the RF signal is shown on the display panel of the transmitter

If no RF signal is being transmitted, e.g. because the receiver is switched off or out of range, all segments of the RF signal level display are grayed out. In addition, **No Link** △ is displayed on the display panel.

Muting the bodypack transmitter or the SKM AVX-S handheld transmitter

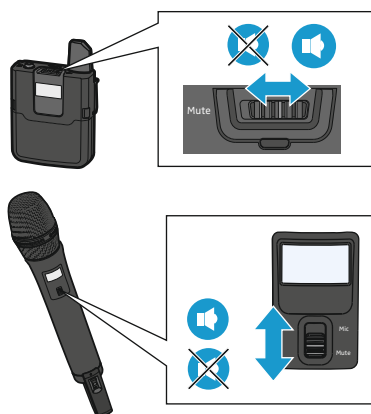

Both the bodypack transmitter and the SKM AVX-S handheld transmitter have a **Mute** switch that mutes the audio signal without switching the transmitter off.

i The SKM AVX handheld transmitter has no **Mute** switch and can therefore not be muted.

- ▶ Slide the **Mute** switch to the position Mute. **Muted** ✗ appears on the display panel of the transmitter. The status LED on both the transmitter and the paired receiver lights up yellow 🌟.
- ▶ Slide the **Mute** switch to the position Mic to unmute the audio signal.



Pairing a receiver with a transmitter

i The receiver and the transmitter of a set are factory pre-paired and therefore ready for immediate use. The radio link is automatically established as soon as both devices are switched on. You can disconnect the existing radio link and establish new radio links to two other devices.

To establish a new radio link between a receiver and a transmitter, proceed as follows:

▶ Switch on the receiver and the transmitter that you want to pair (see page 23).

The status LED on both the receiver and the transmitter indicates the current device status (see page 9).



▶ Long-press, one after the other, the **Pair** buttons of the receiver and the transmitter to be paired until their status LEDs flash alternately green and red. You have 120 seconds between pressing the first button and the second button.

Press pair on receiver appears on the transmitter display panel. Existing radio links to other devices are now disconnected.

▶ Wait for approx. 10 seconds until the radio link is established.

 - Once the radio link is successfully established, **Paired** ✓ appears on the transmitter display panel and the status LED on both the transmitter and the receiver lights up green.

 - If no radio link can be established, **Pairing failed** △ briefly appears on the transmitter display panel, followed by the message **No Link** △. The status LED of the transmitter and/or the receiver lights up red.

For more information on potential problems when establishing a radio link, refer to page 29.

Identifying paired devices

You can perform a pairing identification to see which transmitter is paired with which receiver.

▶ Switch on all devices whose pairing you want to identify (see page 23).

▶ Short-press the **Pair** button of the receiver or of the transmitter.

The transmitter display panel displays the message **This is AVX** and the last four digits of the serial number of the paired receiver. The status LEDs of the paired devices flash green for 10 seconds.

If the receiver or the transmitter is not paired or if the paired device is not switched on or out of range, the status LED does not flash green.





Displaying or adjusting the receiver's audio output level

To display and correctly adjust the receiver's output level:

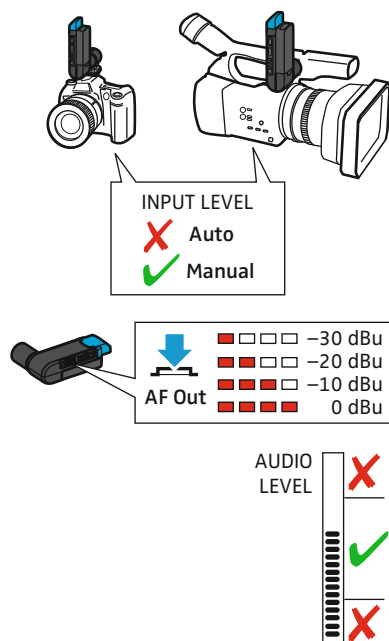

- ▶ Make sure that the radio link is established.
- ▶ If your video or DSLR camera has an automatic level control, the automatic level control must be deactivated. The receiver also has an automatic level control which cannot be deactivated. If both the automatic level control of the video camera and the automatic level control of the receiver are active, they will interfere with one another.

- ▶ Short-press the **AF Out** button on the receiver. The 4-step LED display indicates the current output level. This display automatically goes off after a while.
- ▶ Check the output level display on the video or DSLR camera while using the microphone as usual. The output level is adjusted correctly when the output level display shows full deflection only during the loudest passages. If your video or DSLR camera has a clipping display, this must never light up.

If the output level is adjusted to low or too high:

- ▶ Short-press the **AF Out** button on the receiver while the 4-step LED display is active. The audio output level is reduced by one step each time the **AF Out** button is pressed. When the lowest output level has been reached, you can press the **AF Out** button again to reset the receiver to the highest output level.
- ▶ Alternatively, you can also adjust the input sensitivity of the video camera.



Cleaning and maintaining the products

Important safety information

ATTENTION

Liquids can damage the electronics of the devices

Liquids entering the housing of the devices can cause a short-circuit and damage the electronics.

- ▶ Only clean the devices with a soft, dry cloth.

ATTENTION

Damage to the surfaces of the devices

Solvents or cleansing agents can damage the surfaces of the devices.

- ▶ Do not use any solvents or cleansing agents.
- ▶ Use devices that are frequently worn on the body so that direct skin contact and contact with sweat is avoided.
- ▶ Use a dry cloth to clean all devices that are frequently worn on the body from time to time.

Cleaning the sound inlet basket of the handheld transmitter

- ▶ Unscrew the sound inlet basket from the handheld transmitter.

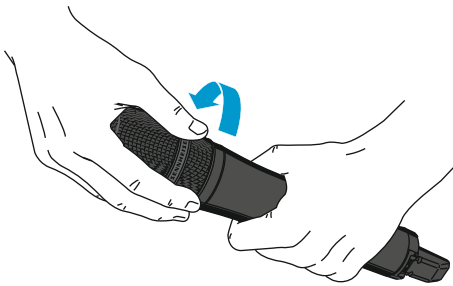

- ▶ Unscrew the upper part of the sound inlet basket from the lower part.

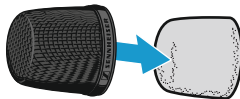
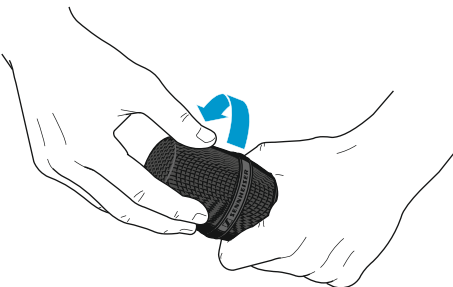

- ▶ Remove the foam insert from the upper part of the sound inlet basket.
- ▶ Use a dry cloth to clean the upper part of the sound inlet basket from the inside and outside.
- ▶ Reinsert the foam insert into the upper part of the sound inlet basket.
- ▶ Screw the upper part of the sound inlet basket back to the lower part.
- ▶ Replace the sound inlet basket on the handheld transmitter and screw it tight.



If a problem occurs ...

Problem	Possible cause	Possible solution	Page
No sound	The receiver is not connected properly.	<ul style="list-style-type: none"> Connect the receiver properly. 	14
	The bodypack transmitter or the SKM AVX-S handheld transmitter is muted. Muted  appears on the transmitter display panel and the status LED on both the receiver and the transmitter lights up yellow.	<ul style="list-style-type: none"> Set the Mute switch of the bodypack transmitter or the SKM AVX-S handheld transmitter to the position Mic. 	25
	The transmitter and the receiver are not paired, the status LED lights up red.	<ul style="list-style-type: none"> Pair the devices properly. 	26
Sound distorted	The automatic level control of the video camera or the DSLR camera is active.	Deactivate the automatic level control of the video camera or the DSLR camera.	–
Sound too low	The output level of the receiver and/or the input sensitivity of the video camera is adjusted too low.	<ul style="list-style-type: none"> Either increase the receiver's output level or increase the video camera's input sensitivity. 	27
Bad reception	The distance between the transmitter and the receiver is too high.	<ul style="list-style-type: none"> Reduce the distance between the transmitter and the receiver. Make sure that there is a direct line of sight between the transmitter and the receiver. Check the RF signal quality on the transmitter. 	13
Devices take a very long time to establish a radio link	The devices need more time to establish the radio links because the distance between the transmitter and the receiver is too large or because there are many active interfering sources in the vicinity of the devices.	<ul style="list-style-type: none"> Move the paired transmitter closer to the receiver. 	13
Devices cannot be paired	No radio link	<ul style="list-style-type: none"> Reduce the distance between the transmitter and the receiver. Make sure that there is a direct line of sight between the transmitter and the receiver. 	13
	Different country variants	Transmitters and receivers of different country variants cannot be paired with each other.	

For more tips and answers to your questions, visit www.sennheiser.com/AVX-support

If a problem occurs that is not listed in the above table or if the problem cannot be solved with the proposed solutions, please contact your local Sennheiser partner for assistance. To find a Sennheiser partner in your country, search at www.sennheiser.com under "Service & Support".



Specifications

System

AF frequency response	20 to 20,000 Hz
Dynamic range	> 120 dB (A)
THD (1 kHz)	typ. 0,1 %
Audio sampling	24 bit/48 kHz
Signal-to-noise ratio	> 90 dB (A)
RF frequency ranges	1,880 to 1,930 MHz (country-specific)
Modulation	GFSK with back channel
Transmission method	TDMA
	fast switching antenna diversity
Latency	19 ms
Relative air humidity	max. 95 %
Temperature range	
Operation:	-10 °C to +55 °C
Storage:	-20 °C to +70 °C

EKP AVX

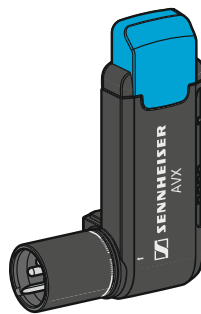

RF sensitivity	< -90 dBm
RF output power of back channel	typ. 15 dBm e.i.r.p.
Audio output	adjustable
XLR, balanced	-30 dBu to 0 dBu in 4 steps
Power supply	BA 20 accupack (Li-Ion, 3.7 V DC)
Operating time	> 4 h
AF connection socket	XLR, male
Weight (incl. accupack)	approx. 87 g

CI 400



AF connector	3.5 mm jack plug, unbalanced
	Connector assignment:

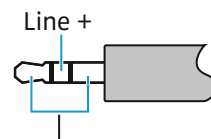

AF connection socket	XLR, female
	Pin assignment:

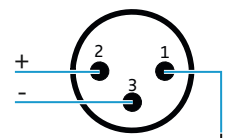

SKM AVX

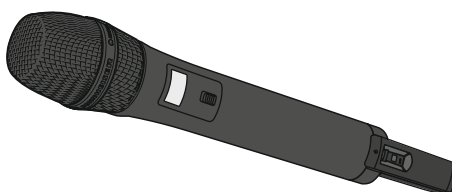

RF output power	adaptive, up to 250 mW (country-specific)
AF frequency response	50 to 20,000 Hz
Input sensitivity	automatic sensitivity adjustment
Power supply	BA 10 accupack (Li-Ion, 3.6 V DC)
Operating time with accupack	typ. 15 h
Display	LCD
Weight (without accupack)	approx. 282 g incl. microphone head

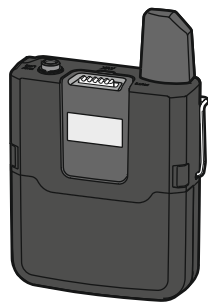

SK AVX

RF output power	adaptive, up to 250 mW (country-specific)
AF frequency response	
Mic:	50 to 20,000 Hz
Line:	20 to 20,000 Hz
Max. input level	
Mic:	2.2 V RMS
Line:	3.3 V RMS
Line input impedance	1 MΩ
Input sensitivity	automatic sensitivity adjustment
Power supply	BA 30 accupack (Li-Ion, 3.7 V DC)
Operating time with accupack	typ. 15 h
AF connection socket	3 5 mm jack socket, lockable
	Connector assignment:

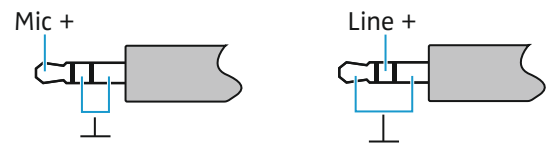

Weight (without accupack) approx. 87 g

Microphones



MMD 835-1	Microphone type	dynamic
	Sensitivity	2.1 mV/Pa
	Pick-up pattern	cardioid
	Max. SPL	154 dB SPL

MMD 42-1	Microphone type	dynamic
	Sensitivity	1.8 mV/Pa
	Pick-up pattern	omni-directional
	Max. SPL	154 dB SPL



ME 2	Microphone type	pre-polarized condenser microphone
	Sensitivity	20 mV/Pa
	Pick-up pattern	omni-directional
	Max. SPL	130 dB SPL



MKE 2	Microphone type	pre-polarized condenser microphone
	Sensitivity	5 mV/Pa
	Pick-up pattern	omni-directional
	Max. SPL	142 dB SPL

In compliance with:	Europe		Radio	EN 301406
			EMC	EN 301489-1/-6
			Safety	EN 60950-1, EN 62311 (SAR)
			RoHS	EN 50581
	USA		FCC 47 CFR 15	
	Canada		Industry Canada RSS 210 CAN ICES-3(B)/NMB-3(B)	



Approved by: USA
 SKM
 SK
 EKP
 Canada
 SKM
 SK
 EKP

Australia/New Zealand
 Japan

FCC ID: DMOSKM1G49WE
 FCC ID: DMOSK1G9WE
 FCC ID: DMOEKP1G9WE

IC: 2099A-SKM1G9WE
 IC: 2099A-SK1G9WE
 IC: 2099A-EKP1G9WE



SKM R 202-SMC049
 SK R 202-SMC050
 EKP R 202-SMC051

USB power supply/charger

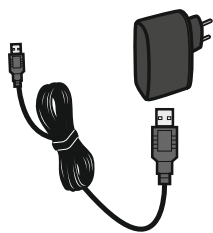

NT 5-10U

Nominal input voltage
 Power frequency
 Nominal output voltage
 Output current
 Standby power consumption
 Energy efficiency level
 Operating temperature
 Storage temperature
 Relative air humidity
 Weight

100 to 240 V~
 50 or 60 Hz
 5 V = = =
 1 A
 ≤ 0.1 W
 V
 0 °C to +40 °C
 -20 °C to +70 °C
 max. 90 %
 approx. 55 g

In compliance with: Europe



EMC EN 55022, EN 55024, EN 60950-1
 Safety EN 50581

RoHs

Commission Regulation (EC) No. 1275/2008

USA/Canada

EMC FCC 47 CFR 15 B
 ICES 003
 CAN ICES-3(B)/NMB-3(B)
 Safety UL 60950-1
 CAN/CSA-C22.2 No. 60950-1

Australia

EMC AS/NZ CISPR 22
 Safety AS/NZL 60950.1

Certified by: Europe

ENEC 22 SIQ

USA/Canada



Australia/New Zealand



Japan



ゼンハイザージャパン(株)

Accupacks

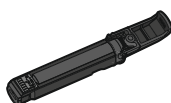

BA 10 Charging capacity
 Output voltage

2,200 mAh
 3.6 V



BA 20 Charging capacity
 Output voltage

430 mAh
 3.7 V



BA 30

Charging capacity
Output voltage

2,030 mAh
3.7 V

In compliance with:

Europe
USA/Canada
Japan
Korea
UN transportation test



EMC EN 301489-1/-6/-17
Safety IEC/EN 62133

Rechargeable
battery cells UL 1642

Accupack UL 2054

DENAN Ordinance Article 1;
Appendix 9 Lithium Ion

Safety K 62133

according to UN Manual of Tests and Criteria,
Part III, section 38.3 Lithium-Ion batteries

Certified by:

USA/Canada



Japan



ゼンハイザージャパン(株)

Korea



Dimensions

Receiver

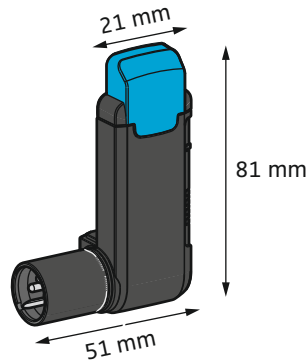

Handheld transmitter

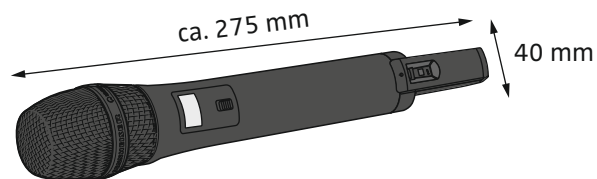

Bodypack transmitter

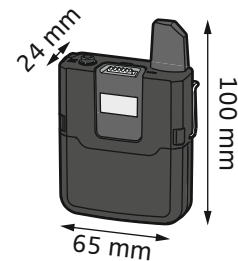



Licenses

CELT Codec

Copyright (c) 2014 IETF Trust and the persons identified as authors of the code. All rights reserved.

Redistribution and use in source and binary forms, with or without modification, are permitted provided that the following conditions are met:

- Redistributions of source code must retain the above copyright notice, this list of conditions and the following disclaimer.
- Redistributions in binary form must reproduce the above copyright notice, this list of conditions and the following disclaimer in the documentation and/or other materials provided with the distribution.
- Neither the name of Internet Society, IETF or IETF Trust, nor the names of specific contributors, may be used to endorse or promote products derived from this software without specific prior written permission.

THIS SOFTWARE IS PROVIDED BY THE COPYRIGHT HOLDERS AND CONTRIBUTORS "AS IS" AND ANY EXPRESS OR IMPLIED WARRANTIES, INCLUDING, BUT NOT LIMITED TO, THE IMPLIED WARRANTIES OF MERCHANTABILITY AND FITNESS FOR A PARTICULAR PURPOSE ARE DISCLAIMED. IN NO EVENT SHALL THE COPYRIGHT HOLDER OR CONTRIBUTORS BE LIABLE FOR ANY DIRECT, INDIRECT, INCIDENTAL, SPECIAL, EXEMPLARY, OR CONSEQUENTIAL DAMAGES (INCLUDING, BUT NOT LIMITED TO, PROCUREMENT OF SUBSTITUTE GOODS OR SERVICES; LOSS OF USE, DATA, OR PROFITS; OR BUSINESS INTERRUPTION) HOWEVER CAUSED AND ON ANY THEORY OF LIABILITY, WHETHER IN CONTRACT, STRICT LIABILITY, OR TORT (INCLUDING NEGLIGENCE OR OTHERWISE) ARISING IN ANY WAY OUT OF THE USE OF THIS SOFTWARE, EVEN IF ADVISED OF THE POSSIBILITY OF SUCH DAMAGE.

Ubuntu Font License

Version 1.0

Preamble

This license allows the licensed fonts to be used, studied, modified and redistributed freely. The fonts, including any derivative works, can be bundled, embedded, and redistributed provided the terms of this license are met. The fonts and derivatives, however, cannot be released under any other license. The requirement for fonts to remain under this license does not require any document created using the fonts or their derivatives to be published under this license, as long as the primary purpose of the document is not to be a vehicle for the distribution of the fonts.

Permission & Conditions

This license does not grant any rights under trademark law and all such rights are reserved.

Permission is hereby granted, free of charge, to any person obtaining a copy of the Font Software, to propagate the Font Software, subject to the below conditions:

1. Each copy of the Font Software must contain the above copyright notice and this license. These can be included either as stand-alone text files, human-readable headers or in the appropriate machine-readable metadata fields within text or binary files as long as those fields can be easily viewed by the user.



2. The font name complies with the following:
 1. The Original Version must retain its name, unmodified.
 2. Modified Versions which are Substantially Changed must be renamed to avoid use of the name of the Original Version or similar names entirely.
 3. Modified Versions which are not Substantially Changed must be renamed to both
 1. retain the name of the Original Version and
 2. add additional naming elements to distinguish the Modified Version from the Original Version. The name of such Modified Versions must be the name of the Original Version, with "derivative X" where X represents the name of the new work, appended to that name.
3. The name(s) of the Copyright Holder(s) and any contributor to the Font Software shall not be used to promote, endorse or advertise any Modified Version, except
 1. as required by this license,
 2. to acknowledge the contribution(s) of the Copyright Holder(s) or
 3. with their explicit written permission.
4. The Font Software, modified or unmodified, in part or in whole, must be distributed entirely under this license, and must not be distributed under any other license. The requirement for fonts to remain under this license does not affect any document created using the Font Software, except any version of the Font Software extracted from a document created using the Font Software may only be distributed under this license.

Termination

This license becomes null and void if any of the above conditions are not met.

Disclaimer

THE FONT SOFTWARE IS PROVIDED "AS IS", WITHOUT WARRANTY OF ANY KIND, EXPRESS OR IMPLIED, INCLUDING BUT NOT LIMITED TO ANY WARRANTIES OF MERCHANTABILITY, FITNESS FOR A PARTICULAR PURPOSE AND NONINFRINGEMENT OF COPYRIGHT, PATENT, TRADEMARK, OR OTHER RIGHT. IN NO EVENT SHALL THE COPYRIGHT HOLDER BE LIABLE FOR ANY CLAIM, DAMAGES OR OTHER LIABILITY, INCLUDING ANY GENERAL, SPECIAL, INDIRECT, INCIDENTAL, OR CONSEQUENTIAL DAMAGES, WHETHER IN AN ACTION OF CONTRACT, TORT OR OTHERWISE, ARISING FROM, OUT OF THE USE OR INABILITY TO USE THE FONT SOFTWARE OR FROM OTHER DEALINGS IN THE FONT SOFTWARE.

Accessories

Receiver

- EKP AVX receiver
incl. NT 5-10U power supply unit

Antenna and connection cables

- CI 400 adapter cable

Transmitters

- SK AVX bodypack transmitter
incl. BA 30 accupack
- SKM AVX handheld transmitter without mute switch
without microphone head
incl. BA 10 accupack
- SKM AVX-S handheld transmitter with mute switch
without microphone head
incl. BA 10 accupack

Microphones for the bodypack transmitter

- ME 2 clip-on microphone incl. accessories
- MKE 2 clip-on microphone incl. accessories

Microphone heads for the handheld transmitter

- MMD 42-1, dynamic, omni-directional
- MMD 835, dynamic, cardioid

Windshields

- MZW 1 windshield for the handheld transmitter

Power supply units

- NT 5-10U USB power supply/charger

Accupacks

- BA 10 accupack for the handheld transmitter
- BA 20 accupack for the receiver
- BA 30 accupack for the bodypack transmitter

Protective case

- Bag for the handheld or bodypack transmitter

Manufacturer Declarations

Warranty

- Sennheiser electronic GmbH & Co. KG gives a warranty of 24 months on this product.
- For the current warranty conditions, please visit our website at www.sennheiser.com or contact your Sennheiser partner.

FOR AUSTRALIA ONLY

Sennheiser goods come with guarantees that cannot be excluded under the Australian Consumer Law. You are entitled to a replacement or refund for a major failure and compensation for any other reasonably foreseeable loss or damage. You are also entitled to have the goods repaired or replaced if the goods fail to be of acceptable quality and the failure does not amount to a major failure.

This warranty is in addition to other rights or remedies under law. Nothing in this warranty excludes, limits or modifies any liability of Sennheiser which is imposed by law, or limits or modifies any remedy available to the consumer which is granted by law.

To make a claim under this warranty, contact Sennheiser Australia Pty Ltd, Unit 3, 31 Gibbes Street Chatswood NSW 2067, Australia; Phone: (02) 9910 6700, email: service@sennheiser.com.au

All expenses of claiming the warranty will be borne by the person making the claim.

The Sennheiser International Warranty is provided by Sennheiser Australia Pty Ltd (ABN 68 165 388 312), Unit 3, 31 Gibbes Street Chatswood NSW 2067, Australia.

In compliance with the following requirements



- WEEE Directive (2012/19/EC)
Please dispose of the products at the end of their operational lifetime by taking them to your local collection point or recycling center for such equipment.
- Battery Directive (2006/66/EC)
The supplied rechargeable batteries or batteries must be recycled. Please dispose of them as special waste or return them to your specialist dealer. In order to protect the environment, only dispose of exhausted batteries or rechargeable batteries.

CE Conformity

- **CE 0682**
- R&TTE Directive (1999/5/EC)
- RoHS Directive (2011/65/EU)
- EMC Directive (2004/108/EC)
- Low Voltage Directive (2006/95/EU)

The declarations are available at www.sennheiser.com. Before putting into operation, please observe the respective country-specific regulations.



Sennheiser electronic GmbH & Co. KG

Am Labor 1, 30900 Wedemark, Germany
www.sennheiser.com

Publ. 06/15, 560094/A01