



**MB 500
OWNER'S MANUAL**

Congratulations!

Your purchase of a new Gallien-Krueger MB Series amplifier is surely the result of much careful consideration on your part. For our part, we at Gallien-Krueger are pleased that you chose us, and are determined that you will be a satisfied customer. In choosing a MB Series amplifier, you now own an amplifier with many unique features which will allow you to create your own distinct sound.

To get the most out of your new purchase, please take a few minutes to read through this manual. If you are in a hurry, we suggest you at least read through the Quick Start section before setting up your new rig. This will help get you started and give you a few quick tips, but is not a substitute for reading the rest of the manual.

Your amplifier should have come with the following items, please check the contents of the box to ensure that you have everything.

Included with your MB 500 Amplifier:

Power cord	1
Owner's manual	1
Warranty card (US only)	1
Safety instructions sheet	1
One button foot switch	1

If your MB Series amplifier did not come with all the items listed, or if you encounter problems while setting up your new equipment, please contact your local dealer or GK as soon as possible.

Gallien-Krueger, Inc.
 2234 Industrial Drive
 Stockton, CA 95206
 phone: (209) 234-7300
 fax: (209) 234-8420
 Internet: www.gallien-krueger.com
 Email: info@gallien.com

We wish you a lifetime of good playing and remember to always have fun!



GK Philosophy

I have never seen the point in doing things the way others have done them. I also have not been very interested in following the latest fad. I'm a Stanford educated engineer who worked my way through school as a musician. Like all musicians, I have lugged amplifiers up stairways and into car trunks, always wondering why these things had to be so heavy, bulky, and hard to handle.

As the principal innovator at GK, our products reflect my attitudes and life experiences. I don't model my designs after other manufacturers' products. Instead, I believe new and old problems are best solved with new solutions. Having taken our own path, GK products enjoy a unique, unmatched sound, allowing you every opportunity to make an original statement.

Having supported my products for over thirty years, I have learned from the story they tell. Gallien-Krueger is a reflection of that story, and has a commitment to support that legacy. Just as the products I created over thirty five years ago are still telling their story, the products we create today will be talking to us tomorrow.

We'll be listening,

Robert Gallien
 Founder and President

MB 500

Table Of Contents

Safety Information _____	4
Quick Start _____	5
Front Panel Controls _____	6
Rear Panel Features _____	7
Sample Settings _____	8
Sound Tips _____	9
Installation and Maintenance _____	10
Tech Talk _____	11
Specifications _____	12

*All Features and specifications are subject to change without notice





Please read the Safety Information section on page 4 and installation instructions on page 12 before continuing.

Gallien-Krueger
2234 Industrial Drive
Stockton, CA 95206
phone: 209.234.7300
fax: 209.234.8420

email: info@gallien-krueger.com
internet: www.gallien-krueger.com

Warning!

This amplifier is capable of producing high sound pressure levels. Continued exposure to high SPL's can cause damage to your hearing. Always set the volume at a safe listening level or use hearing protection if the unit is operated at higher levels.

	CAUTION RISK OF ELECTRIC SHOCK DO NOT OPEN	
CAUTION: TO REDUCE THE RISK OF ELECTRIC SHOCK, DO NOT REMOVE TOP COVER. NO USER-SERVICEABLE PARTS INSIDE. REFER SERVICING TO QUALIFIED SERVICE PERSONNEL.		
	The lightning flash with arrow head symbol, within the equilateral triangle, is intended to alert the user to the presence of uninsulated "dangerous voltage" within the product inclosure that may be of sufficient magnitude to constitute a risk of electric shock to persons	
The exclamation point within an equilateral triangle, is intended to alert the user to the presence of important operating and maintenance (servicing) instructions in the literature accompanying the appliance.		
WARNING: TO REDUCE THE RISK OF FIRE OR ELECTRIC SHOCK, DO NOT EXPOSE THIS APPLIANCE TO RAIN OR MOISTURE		
CAUTION: TO PREVENT ELECTRIC SHOCK, MATCH WIDE BLADE OF PLUG TO WIDE SLOT, FULLY INSERTED.		
ATTENTION: POUR EVITER LES CHOCS ELECTRIQUES, INTRODUIRE LA LAME LA PLUS LARGE DE LA FICHE DANS LA BORNE CORRESPONDANTE DE LA PRISE ET POUSSER JUSQU'AU FOND.		

Safety Information

Please read all enclosed safety precautions before connecting or operating this product.

Verify Line Voltage and Amperage

Your amplifier has been factory configured for use with the specific line voltage for your location only. For example, units set to operate within countries that supply 100-120 volt electrical service are not compatible with 230-240 volt systems used in other countries.

**120 Volt/60Hz 15 amp circuit for the USA and Canada.
 230 Volt/(50/60Hz) 10 amp circuit for the UK and Australia.
 230 Volt/(50/60Hz) 10 amp circuit for Europe.
 100 Volt/50Hz 15 amp circuit for Japan.
 220 Volt/50Hz 10 amp circuit for Korea.
 Proper AC circuit for all other countries.**

Connecting the amplifier to a line with specifications other than indicated above can create safety and fire hazard, and may damage the amplifier. If you have any questions about the voltage requirements for your specific model, or about the line voltage in your area, contact your dealer before plugging the unit into a wall outlet.

Verify AC Circuit Capacity Before Use:

The high power output of your amplifier may require heavy current draw under full-load conditions. To insure proper performance and avoid potential safety hazards, we recommend connection to line circuits with amperage specified "as above". Connecting to the same circuit used by other heavy-power devices, such as high-wattage lights, may cause circuit breakers to trip. It is always a good idea to avoid using any audio equipment on the same AC circuit as equipment with motors, such as air conditioners or refrigerators. This will lessen the possibility of power variation and electrical start-up noise affecting your sound.

Please refer to page 10 for more instructions concerning installation.

AC Power Cord:

To avoid safety hazards, use only the power cord supplied with your unit. If a replacement cord is needed, make certain to use a standard IEC compliant cord. Damaged power cords should be replaced immediately. When setting up, make certain that the AC plug is easily accessible. If you do not intend to use the amplifier for a considerable length of time, disconnect the plug from the AC Mains Socket. Do not use an extension cord.

Earth Grounding Connection:

To prevent electric shock, do not remove the grounding plug on the power cord, or use any plug or extension cord that does not have a grounding plug provided. Make certain that the AC outlet is properly grounded as well. Do not use an adapter plug with this product.

Do Not Open the Amplifier Enclosure:

There are no user serviceable parts inside this product. Opening the amplifier enclosure may present a shock hazard. Modification to the product will void your warranty. If liquid enters the unit, or any metal object such as a paper clip accidentally falls inside the enclosure, disconnect the unit from the AC power source immediately and consult an authorized service station.

Setup:

To insure proper operation and to avoid potential safety hazards, place the unit on a firm, level surface. Do not plug or unplug the instrument or speaker cable while the amplifier power is on.

Heat & Ventilation:

Make sure there is space provided for proper ventilation. Avoid using in extremely hot or cold locations and areas that are exposed to direct sunlight or near heating equipment. Avoid using in moist or high humidity areas. **NEVER BLOCK THE FAN VENT HOLES ON THE SIDES OF THE UNIT.**

Quick Start

The MB 500 amplifier is designed to be simple to operate. All controls have a well defined purpose. These directions will take you through the basics and give you a good start for setting up your sound.

1. Plug it in:

Set the power switch to Off and connect the supplied power cord, from the amplifier AC receptacle, to an AC power outlet of proper voltage and power rating (see safety information on page 5 for details).

2. Connect your cabinets:

Connect your speaker cabinets to the amplifier outputs marked Speaker. Use a two conductor or the GK 4 conductor Speakon cable only.

Maximum Recommended Speaker Loads:

One 4 Ohm, or two 8 Ohm cabinets.

3. Initial front panel control settings:

Set all EQ controls and contour knob to 12 o'clock. Set the Input Volume, Master and Master B controls at 0. The Boost knob should be set to 12 o'clock and the boost button (between Boost and Master B knobs) in the out position.

4. Plug in your bass:

Using an instrument (shielded) cable, connect your bass to the Input jack and press the power switch on. If you have active tone controls on your bass, turn all of the controls to the middle or flat position and turn the volume all the way up. If you have conventional, passive tone controls, turn all tone and volume controls all the way up.

5. Level and Master Volume settings:

Set the Master Volume to 3 o'clock. Turn the Input Volume knob up as you play to the desired output level. If the clip light (pad button) flashes more than occasionally, press the -10db pad button in and turn the Input Volume knob up. If it is still lighting often, try turning the volume down on your bass.

6. Boost/Master B:

Engage the button located between the Boost and Master B knobs. This will activate the Boost section of the pre amp. This can also be done with the included foot switch. Turn up the Master B knob to the desired volume level.*

You should be hearing your bass quite well through the Master and Master B channels. At this point you can experiment with different EQ, Contour and Boost settings. Various sample settings can also be found on page 8.

* It is recommended that the limiter is used for during high volume applications.

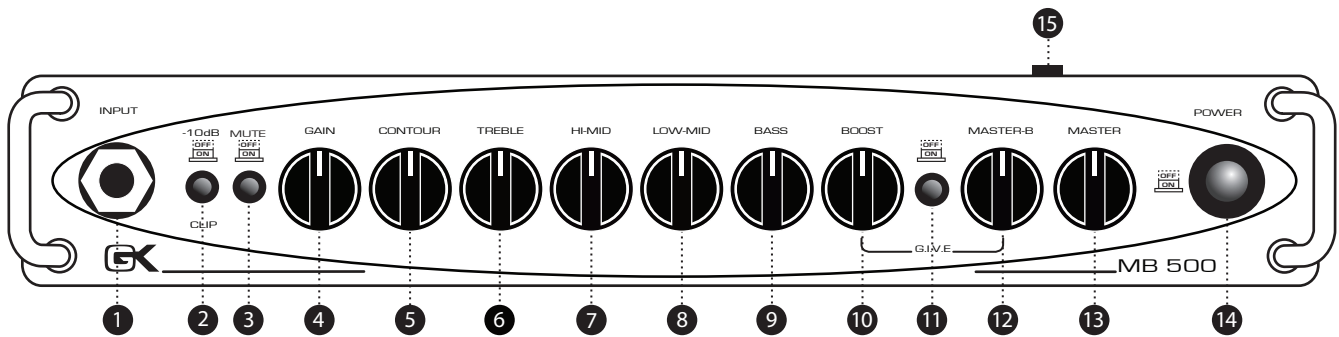

Front Panel Features

- ① **Input:** A standard ¼” input jack to connect active or passive basses using a shielded cord.
- ② **-10 dB Pad/Clip indicator:** Input attenuator button. This button is generally set to the out position except in cases where the clip LED flashes more than occasionally. It may be necessary to “pad” the input if you are using a bass with active electronics or very high output. The pad button light flashes red when the input is being overdriven. If the -10dB is pressed and the clip indicator still flashes frequently, reduce the volume on your bass.
- ③ **Mute:** Set this switch to “on” when tuning or unplugging your bass. No signal will be sent to the speakers or the P.A. system. When muted this button turns red.
- ④ **Gain:** Sets the preamp gain after the input stage. It is used in conjunction with the input pad to optimize the amplifier’s headroom.
- ⑤ **Contour:** As part of the amps active equalization the contour control decreases the mid-range frequencies while boosting low and high frequencies.
- ⑥ **Treble:** Boost and cut at 7 kHz +14 dB shelving type. Use this control to add or remove edge and definition.
- ⑦ **Hi-Mid:** Boost and cut at 1 kHz +6 dB. A “Q Optimized,” band pass type, this works on lower string harmonics and effects the punch of your sound.
- ⑧ **Low-Mid:** Boost and cut at 250Hz +6dB/-10 dB. A “Q optimized” band pass type, this works for main body of your sound.
- ⑨ **Bass:** Boost and cut a 60Hz +10 dB, shelving type. This is used to control the low end push.
- ⑩ **Boost:** This is a post E.Q. gain stage using G.I.V.E. technology which adds “growl” as it is turned up.
- ⑪ **GIVE:** This button activates the Boost and Master B volume control. This can also be activated using the foot switch (included).
- ⑫ **Master B:** This is the master volume control when boost is activated.
- ⑬ **Master:** This is the master volume control when the boost is inactive.
- ⑭ **Power Switch:** Turns the amplifier on and off. In the on position, the ring surrounding the button will light red during power up then changes to blue, indicating the amp is ready for normal operation. Should the amp experience a fault (over heat or over current) the amp will mute and the ring will light red until the condition is corrected. This LED turns off when the power is switched off. This turns the amp off but it does not completely disconnect the power from the AC mains.
- ⑮ **Limiter:** When this button is engaged it prevents the power amp from distorting. It is recommended that this feature is used for during high volume applications.

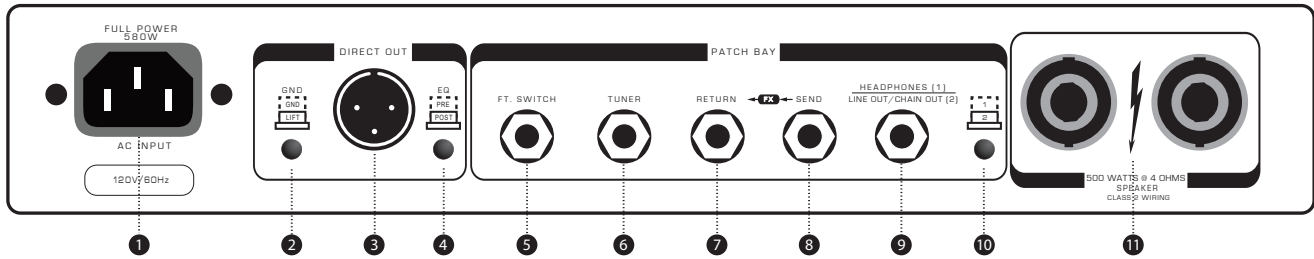

Rear Panel Features

- ❶ **AC Receptacle:** The detachable power cord plugs in here.
- ❷ **Ground Lift:** This switch disconnects the ground of the balanced, XLR output to eliminate hum and buzz when connecting to equipment that is running on a different ground system.
- ❸ **Balanced Direct Out:** This electronically balanced output allows a direct connection to a P.A. system.
- ❹ **Pre/Post EQ Button:** This button switches the direct out signal to be before or after the EQ.
- ❺ **Foot switch Input:** A foot switch is provided to engage Boost and Master B modes.
- ❻ **Tuner Output:** This output comes directly off of the input stage and can be patched to a tuner using a shielded patch cord. This output is unaffected by the Tuning Mute Feature.
- ❼ **Return:** This input allows the signal from outboard effects devices to be inserted before the boost section.
- ❽ **Send:** This output allows signal from the preamp to be fed to outboard effects devices from a point after the EQ section.
- ❾ **Headphone/Line out/Chain out:** When switched, this output allows the user to send a direct (unbalanced) line out to devices with unbalanced inputs such as personal multitrack recorders. This connection requires a shielded patch cord. The Chain out allows the user to connect directly to a GK MBP powered extension cabinet. This connection is made with a balanced, tip, ring, sleeve to male XLR cable.
- ❿ **Headphone/Line out/Chain Out switch:** This switch toggles the output from headphone to line out.
- ⓫ **Speaker:** Power amp output to speaker cabinet. Delivers 500w into 4 Ohm loads. Lower impedances such as 8 Ohms or 16 Ohms and no load are acceptable. One 4 Ohm speaker and one 8 Ohm speaker is not recommended. Use a two conductor or the GK 4 conductor Speakon cable only.

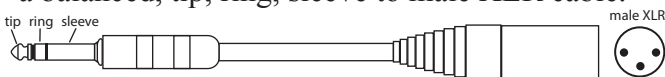

Unswitched, this headphone jack can be used to

MB 500

Settings & Sounds:

The MB 500 is versatile in its sound and tone. Below are a few suggested amp settings that can be used as starting points to define your own sound.

*Volume settings should be adjusted to appropriate level. It is recommended that the limiter is used for during high volume applications.

Note: At higher playing levels the contour should be set lower for mid-range clarity. To get 800RB voicing, the contour should be set to 0 or 10 only.

Slap:

Both pickups recommended.

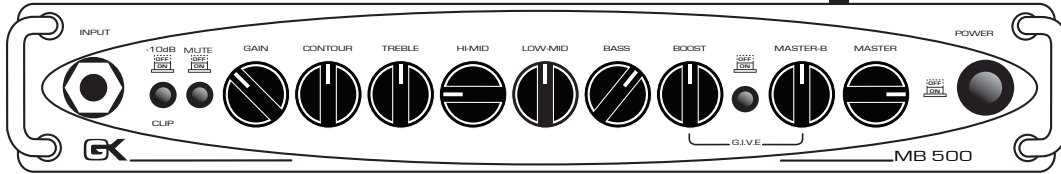

Rock:

Both pickups recommended.

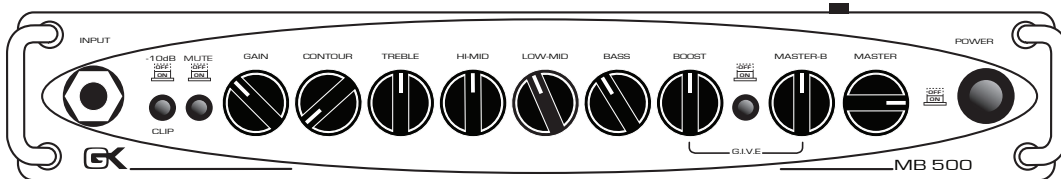

Reggae:

Front pickup recommended.

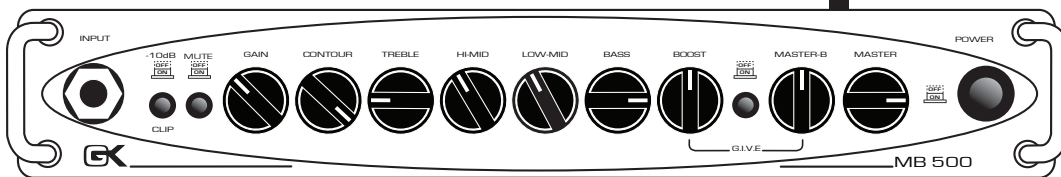

Jazz/Fusion:

Both pickups recommended.

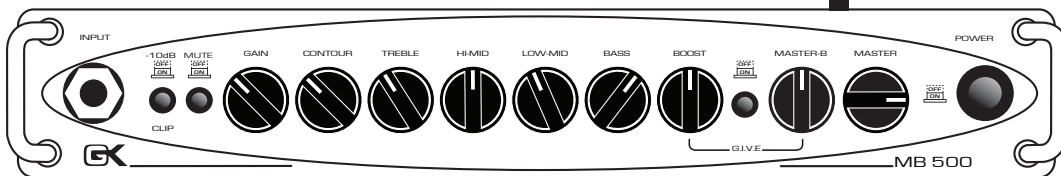

Sound Tips

The MB 500 has several unique features which, if used properly, will obtain the sound you have been searching for.

The Equalizer:

The Equalizer is used to fine tune your sound. When adjusting making adjustments, do it just a little at a time. These are active circuits and small changes can make a big difference in your sound. With a little experimentation you will find that this equalizer is very easy to use and provides you with a large variety of great sounds unique to GK.

Contour:

Increasing the Contour level will scoop out midrange frequencies while boosting the highs and lows. The sound, once again, is unique to GK and available on any other Bass amp. Lower contour settings are recommended for midrange clarity at higher playing levels.

Boost/Master B:

Turning up the Boost control will add a little growl to your tone by adding a small amount of even order harmonic distortion. This is an unmistakable GK trade mark sound that you will surely grow to appreciate. Raising the Boost while lowering Master B will add more growl while keeping the sound level the same. You can use Master B to increase or lower the overall output volume when switching the Boost on via the front panel or from the included foot switch. In either normal or boost mode, the cleanest sound is obtained with Master Volume settings at 3 o'clock.

Direct Out:

The MB Series provides a low noise, high quality balanced direct output for connection to PA and recording consoles. A Ground Lift switch is

included to remove hum and buzz when connecting to equipment powered by a different ground system.

With the Pre/Post EQ switch set to "Pre" (Out), the direct output signal is fed directly from the input stage providing a low noise output superior to external direct boxes and impedance transformers. In the "Pre" position, the direct output signal is only effected by the Input Volume, -10db Pad and Mute. This allows you to adjust your tone and volume on stage without changing the Direct Output signal level and confusing your sound man.

Changing the Pre/Post EQ switch to "Post" (In), sends the "GK Sound" (EQ settings etc.) and preamp response to the Direct Out jack. This gives you complete control over the Direct Out's tone and volume.

Limiter:

When this button is engaged it prevents the power amp from distorting. It is recommended that this feature is used for during high volume applications.

Installation:

To insure proper operation and to avoid potential safety hazards, place the unit on a firm, level surface.

Ventilation:

Make certain that proper space is provided for ventilation. Never block the fan vent holes located on the sides of the amplifier. If the amplifier will be installed in a rack or other enclosed area, make sure that there is sufficient air movement within the enclosure to allow proper cooling. Consult your dealer for more information. Avoid installation in extremely hot or cold locations and areas that are exposed to direct sunlight or near heating equipment. Avoid moist or humid locations.

Remember, power amplifiers generate heat. The ventilation slots on the enclosure are specifically designed to remove this heat. Blocking or placing other electronic equipment near the heat dissipation system may possibly affect the long term reliability of both your amplifier and the other equipment.

Moving the Unit:

Before moving the unit, be certain to disconnect any interconnection cords with other components and make sure that you disconnect the unit from the AC outlet.

Cleaning:

When the unit gets dirty, clean only with a dry cloth. Never use benzene, thinner, alcohol or other volatile cleaning agents. Do not use abrasive cleaners, as they may damage the finish of metal parts. Avoid spraying insecticides near the unit.

Maintenance:

Your new amplifier is rugged. It was built to give you a lifetime of trouble free operation if it is operated in accordance with the instructions contained in this manual. The only maintenance required is cleaning. If you are going to move your amplifier around frequently, we recommend a road case to protect it from scratches and road wear.

Packaging:

The carton and packing materials used in shipping your new amplifier were specifically designed to cushion it from the shocks and vibration that occur during transport. We suggest that you save the carton and packing materials for use in shipping in the event you move or the amplifier needs repair.

Tech Talk

Characteristics of the MB 500:

The MB 500 is a flexible, state-of-the-art amplifier designed to deliver maximum performance while remaining small, lightweight and simple to operate. This is accomplished through a few, very important features:

- **Class D power supply and power amp.**
- **Four, Bass specific bands of active equalization for precise tone control.**
- **Balanced direct output eliminates the need for a direct box.**
- **Continuously variable fan cooling.**

Equalization:

Standard tone controls and graphic equalizers give you plenty of variation, but they don't provide what the instrument really needs. The fact is, graphic equalizers are intended for room equalization. The equalization in Gallien-Krueger amplifiers reflects 40 years of continuous development and refinement.

The GK equalizer is unique to the industry, it's not just a normal four band equalizer. Each section is a special circuit optimized to perform a Bass specific job in its range of operation.

These sections are wired in series, so they add to one another creating a tremendously flexible equalizer that sounds natural at any setting. Now it is possible to obtain the sound you desire.

Contour:

The Contour is used to completely revoice the amplifier. The Contour control tunes between two different shaping circuits with greatly different responses. With the control all the way up, the low end is slightly boosted, the mids are dropped and the high end is pushed up. This is only found in GK amplifiers.

“G.I.V.E.” Technology:

As in all GK pre-amps, the MB Series pre-amp incorporates what we call G.I.V.E (Gate Induced Valve Effect) technology. We use field effect devices with the gate biased in a way that emphasizes the optimum harmonic content of the signal. Working in concert with our unique Four Band Active Equalizer and three stage Voicing Filter Section, G.I.V.E. technology produces a consistently pleasing bass tone.

Cool Running = Reliability:

To cool the amp when its being driven hard, we've designed a temperature sensitive fan cooling system. When the amp is under a light load, the fan is off or running at a low speed, reducing fan noise. As the amp works harder, the fan speed increases to keep everything cool.

Smart Protection Circuitry:

The MB Series protection circuitry constantly monitors for unsafe operating conditions such as short circuits, miss wired speaker cables, blown speakers, improper ventilation, and incorrect speaker configurations. In addition, protection is provided during power up/down. If the MB Series senses any unsafe operating conditions, the output signal is immediately muted and the power light changes from blue to red. The amplifier will remain muted until the fault is removed. If the protection circuit activates while playing, turn the amplifier off and check the amplifier speaker output connections. Be sure that you are not exceeding the maximum recommend load described in this manual. If the problem persists, contact GK directly for technical advice.

In Closing:

You should now have a thorough understanding of how your new MB Series amplifier works and what advantages it can offer you in getting “your” sound. We thank you for reading the Owner's Manual and wish you the best of times! Please send us your comments via www.gallien-krueger.com or email us at sales@gallien.com.

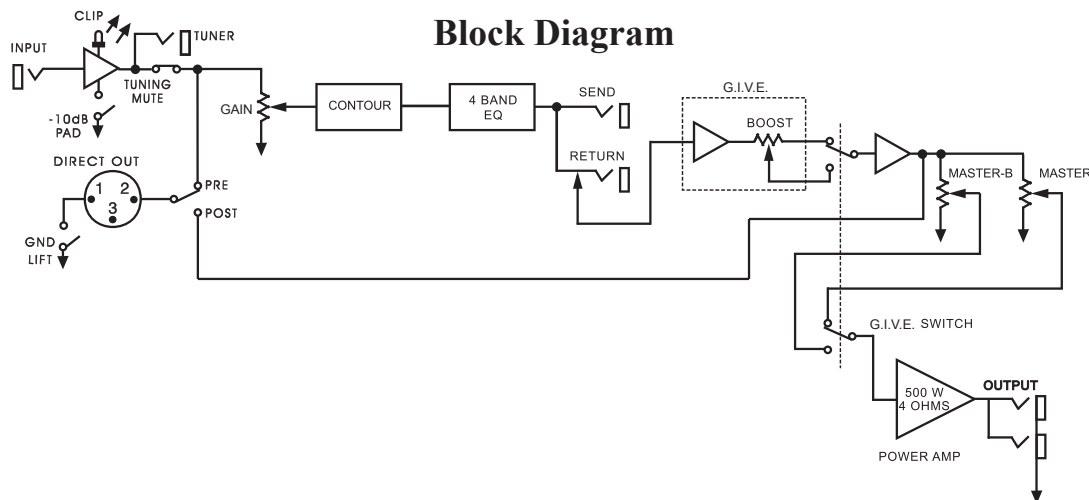

MB 500 SPECS

Output Power: 350W @ 8 Ohms
500W @ 4 Ohms

Input Section:

Maximum Input Level 0.6V Rms
With -10dB pad 1.6V Rms
Input Impedance 1M Ohms
Send Output Impedance 220 Ohms
Return Input Impedance 50K Ohms
Tuner Output Impedance 10K Ohms
Direct Output Impedance 500 Ohms

Equalizer:

Bass +/-10dB @ 60Hz
Lo-Mid +6dB/-10dB @ 250Hz
Hi-Mid +6dB/-10dB @ 1KHz
Treble +/-14dB @ 7KHz

Voicing Filters:

Contour +2dB @ 50Hz/
-10dB @ 500Hz/
+3dB @ 7 KHz

Noise: -90 dB reference to 500W/350W, "A" Weighted

Cooling: Variable Speed Fan

Amplifier Protection:

Full short circuit, thermal and RF protection.
Stable into reactive and mismatch loads.
Five second muted warm-up.

Dimensions (HxWxD):

1.75"[44.45mm] x 11"[279.4mm] x 9"[228.67mm].
1 Rack spaces.

Weight:

3 lbs. 12 oz. 1.7 Kg.

Power requirements:

U.S.A./Canada 120V/60Hz.
580W(full power), 75.6W(average power)
Europe 230V/50Hz/60Hz
580W(full power), 75.6W(average power)
Japan 100V/50Hz
580W(full power), 75.6(average power)

GK GALLIEN-KRUEGER

MB 500
Owner's Manual
Part # 160-0510-A