

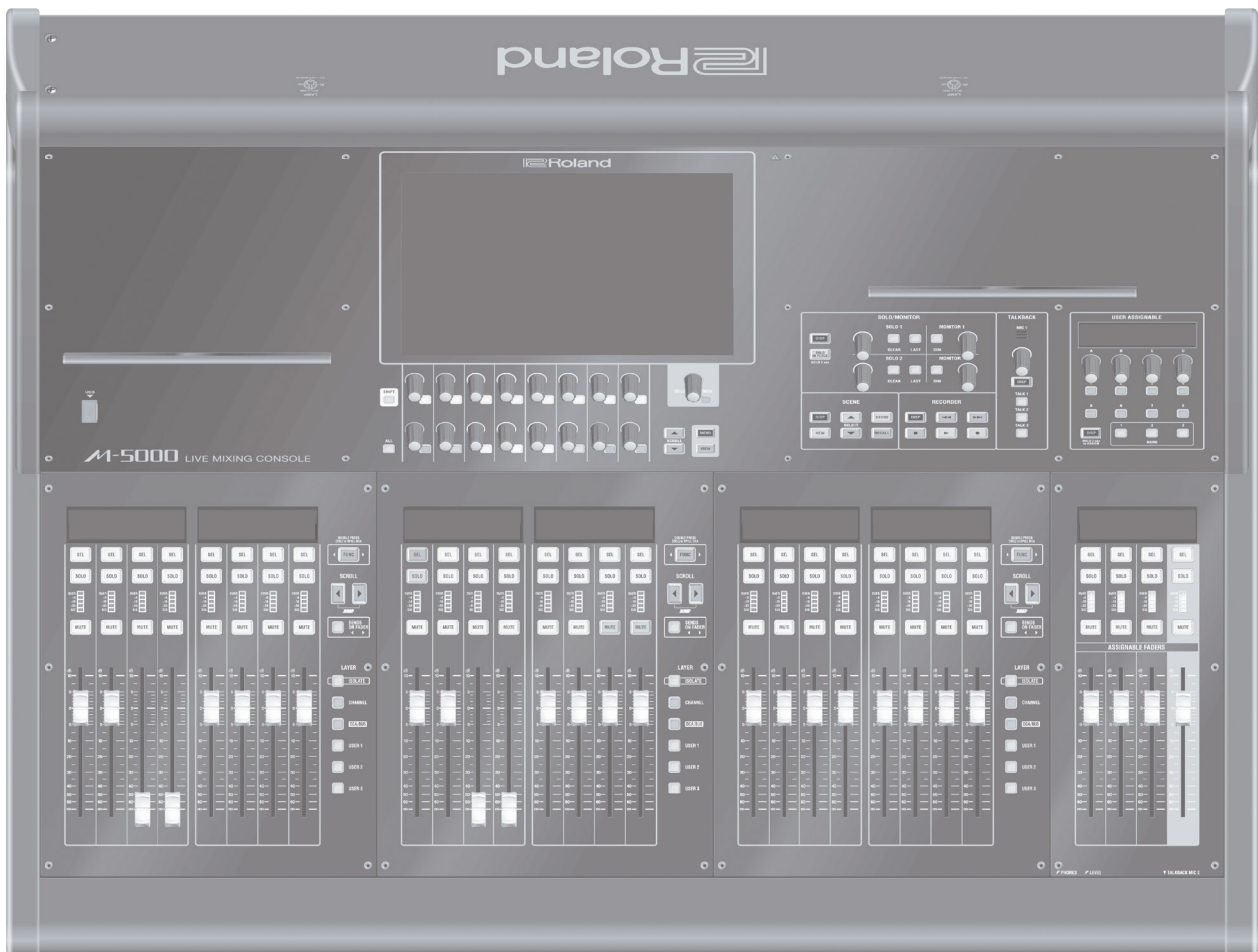



LIVE MIXING CONSOLE M-5000 / M-5000C

Quick Start



Before using the M-5000 / M-5000C, ensure that its system program is at the most recent version. For information on available upgrades for the system program, see the Roland website.

WARNING: To reduce the risk of fire or electric shock, do not expose this apparatus to rain or moisture.

	CAUTION RISK OF ELECTRIC SHOCK DO NOT OPEN	
ATTENTION: RISQUE DE CHOC ELECTRIQUE NE PAS OUVRIIR		
CAUTION: TO REDUCE THE RISK OF ELECTRIC SHOCK, DO NOT REMOVE COVER (OR BACK). NO USER-SERVICEABLE PARTS INSIDE. REFER SERVICING TO QUALIFIED SERVICE PERSONNEL.		



The lightning flash with arrowhead symbol, within an equilateral triangle, is intended to alert the user to the presence of uninsulated "dangerous voltage" within the product's enclosure that may be of sufficient magnitude to constitute a risk of electric shock to persons.



The exclamation point within an equilateral triangle is intended to alert the user to the presence of important operating and maintenance (servicing) instructions in the literature accompanying the product.

INSTRUCTIONS PERTAINING TO A RISK OF FIRE, ELECTRIC SHOCK, OR INJURY TO PERSONS.

IMPORTANT SAFETY INSTRUCTIONS SAVE THESE INSTRUCTIONS

WARNING - When using electric products, basic precautions should always be followed, including the following:

1. Read these instructions.
2. Keep these instructions.
3. Heed all warnings.
4. Follow all instructions.
5. Do not use this apparatus near water.
6. Clean only with a dry cloth.
7. Do not block any of the ventilation openings. Install in accordance with the manufacturers instructions.
8. Do not install near any heat sources such as radiators, heat registers, stoves, or other apparatus (including amplifiers) that produce heat.
9. Do not defeat the safety purpose of the polarized or grounding-type plug. A polarized plug has two blades with one wider than the other. A grounding type plug has two blades and a third grounding prong. The wide blade or the third prong are provided for your safety. If the provided plug does not fit into your outlet, consult an electrician for replacement of the obsolete outlet.
10. Protect the power cord from being walked on or pinched particularly at plugs, convenience receptacles, and the point where they exit from the apparatus.
11. Only use attachments/accessories specified by the manufacturer.
12. Unplug this apparatus during lightning storms or when unused for long periods of time.
13. Refer all servicing to qualified service personnel. Servicing is required when the apparatus has been damaged in any way, such as power-supply cord or plug is damaged, liquid has been spilled or objects have fallen into the apparatus, the apparatus has been exposed to rain or moisture, does not operate normally, or has been dropped.

For the U.K.

WARNING: THIS APPARATUS MUST BE EARTHED

IMPORTANT: THE WIRES IN THIS MAINS LEAD ARE COLOURED IN ACCORDANCE WITH THE FOLLOWING CODE.
GREEN-AND-YELLOW: EARTH, BLUE: NEUTRAL, BROWN: LIVE

As the colours of the wires in the mains lead of this apparatus may not correspond with the coloured markings identifying the terminals in your plug, proceed as follows:

The wire which is coloured GREEN-AND-YELLOW must be connected to the terminal in the plug which is marked by the letter E or by the safety earth symbol  or coloured GREEN or GREEN-AND-YELLOW.

The wire which is coloured BLUE must be connected to the terminal which is marked with the letter N or coloured BLACK.

The wire which is coloured BROWN must be connected to the terminal which is marked with the letter L or coloured RED.



WARNING



DO NOT INGEST BATTERY, CHEMICAL BURN HAZARD

This product contains a coin/button cell battery. If the coin/button cell battery is swallowed, it can cause severe internal burns in just 2 hours and can lead to death.

Keep new and used batteries away from children. If the battery compartment does not close securely, stop using the product and keep it away from children. If you think batteries might have been swallowed or placed inside any part of the body, seek immediate medical attention.

CAUTION: Danger of explosion if battery is incorrectly replaced.
Replace only with same or equivalent type.

AVERTISSEMENT: Pour éviter les risques d'incendie ou de choc électrique, ne pas exposer cet appareil à la pluie ou à l'humidité.

	ATTENTION RISQUE DE CHOC ÉLECTRIQUE NE PAS OUVRIR	
ATTENTION: RISQUE DE CHOC ÉLECTRIQUE NE PAS OUVRIR		
ATTENTION: POUR ÉVITER LES RISQUES DE CHOC ÉLECTRIQUE, NE PAS OUVRIR LE COUVERCLE (OU L'ARRIÈRE). AUCUN DES ÉLÉMENTS INTERNES NE DOIT ÊTRE RÉPARÉ PAR L'UTILISATEUR. NE CONFIER L'ENTRETIEN QU'À UN PERSONNEL QUALIFIÉ.		



L'éclair fléché dans un triangle équilatéral est destiné à avertir l'utilisateur de la présence, dans l'appareil, d'une zone non-isolée soumise à une « haute-tension » dont l'intensité est suffisante pour constituer un risque d'électrocution.



Le point d'exclamation dans un triangle équilatéral est destiné à attirer l'attention de l'utilisateur sur la présence d'informations de fonctionnement et maintenance (entretien) importantes dans la brochure accompagnant l'appareil.

INSTRUCTIONS RELATIVES AUX RISQUES D'INCENDIE, DE CHOC ÉLECTRIQUE OU DE BLESSURES.

INSTRUCTIONS IMPORTANTES DE SÉCURITÉ CONSERVER CES INSTRUCTIONS

AVERTISSEMENT - Lors de l'utilisation d'appareils électriques, des précautions de base doivent toujours être respectées, y compris ce qui suit :

1. Bien lire ces instructions.
2. Conserver ces instructions.
3. Tenir compte de tous les avertissements.
4. Suivre toutes ces instructions.
5. Ne pas utiliser pas l'appareil près de l'eau.
6. Nettoyer uniquement avec un chiffon sec.
7. Ne pas obstruer les ouïes de ventilation. Installer conformément aux instructions du fabricant.
8. Ne pas installer à proximité d'une source de chaleur telle qu'un radiateur, une bouche de chaleur, un poêle ou d'autres appareils (dont les amplificateurs) produisant de la chaleur.
9. Ne pas détériorer la sécurité de la fiche polarisée ou de la fiche de terre. Une fiche polarisée comporte deux lames dont l'une est plus large que l'autre. Une fiche de terre comporte deux lames et une troisième broche de mise à la terre. La lame la plus large ou la troisième broche assure la sécurité de l'utilisateur. Si la fiche fournie ne s'adapte pas à la prise électrique, demander à un électricien de remplacer la prise hors normes.
10. Protéger le cordon d'alimentation afin que personne ne marche dessus et que rien ne le pince, en particulier au niveau des fiches, des prises de courant et du point de sortie de l'appareil.
11. Utiliser uniquement les pièces / accessoires spécifiés par le fabricant.
12. Débrancher l'appareil pendant les orages ou quand il ne sera pas utilisé pendant longtemps.
13. Confier toute réparation à du personnel qualifié. Des réparations sont nécessaires si l'appareil est endommagé d'une façon quelconque, par exemple : cordon ou prise d'alimentation endommagé, liquide renversé ou objet tombé à l'intérieur de l'appareil, exposition de l'appareil à la pluie ou à l'humidité, appareil qui ne marche pas normalement ou que l'on a fait tomber.



AVERTISSEMENT

NE PAS INGÉRER LA PILE, RISQUE DE BRÛLURE CHIMIQUE

Ce produit contient une pile de la taille d'une pièce de monnaie/bouton. Si cette pile est ingérée, elle est susceptible de causer des brûlures internes graves en seulement 2 heures et peut entraîner la mort. Garder les piles neuves et usées hors de portée des enfants. Si le compartiment de la pile ne se ferme pas de manière sécuritaire, cesser d'utiliser le produit et le garder hors de portée des enfants. Si vous pensez que des piles ont été ingérées ou insérées dans toute partie du corps, consulter immédiatement un médecin.

ATTENTION: Danger d'explosion si la pile n'est pas remplacée correctement.
Remplacez la pile uniquement par une pile de type identique ou équivalent.

USING THE UNIT SAFELY

INSTRUCTIONS FOR THE PREVENTION OF FIRE, ELECTRIC SHOCK, OR INJURY TO PERSONS

About ⚠ WARNING and ⚠ CAUTION Notices

⚠ WARNING	Used for instructions intended to alert the user to the risk of death or severe injury should the unit be used improperly.
⚠ CAUTION	Used for instructions intended to alert the user to the risk of injury or material damage should the unit be used improperly. * Material damage refers to damage or other adverse effects caused with respect to the home and all its furnishings, as well to domestic animals or pets.

About the Symbols

	The ⚠ symbol alerts the user to important instructions or warnings. The specific meaning of the symbol is determined by the design contained within the triangle. In the case of the symbol at left, it is used for general cautions, warnings, or alerts to danger.
	The ⓧ symbol alerts the user to items that must never be carried out (are forbidden). The specific thing that must not be done is indicated by the design contained within the circle. In the case of the symbol at left, it means that the unit must never be disassembled.
	The ● symbol alerts the user to things that must be carried out. The specific thing that must be done is indicated by the design contained within the circle. In the case of the symbol at left, it means that the power-cord plug must be unplugged from the outlet.

ALWAYS OBSERVE THE FOLLOWING

⚠ WARNING

Make sure that the power cord is grounded

Connect mains plug of this model to a mains socket outlet with a protective earthing connection.



To completely turn off power to the unit, pull out the plug from the outlet

Turning off the power switch does not completely cut off the main power to the M-5000. When it is necessary to switch off the power completely, turn off the power switch on the M-5000 and the power switch on any backup power unit connected to the EXT.POWERDCINPUT connector; then unplug the M-5000 from the power outlet. To make this possible, plug the power cord into a power outlet that is as close to the M-5000 as possible and can be reached immediately.



Secure a sufficient amount of space at the setup location

Since this unit normally emits a slight amount of heat, make sure to secure sufficient space around it, as shown below.

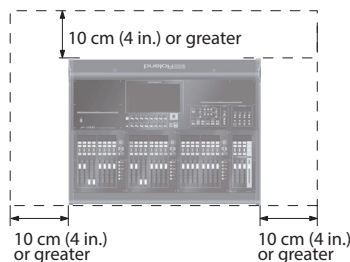

Do not disassemble or modify by yourself

Do not carry out anything unless you are instructed to do so in the owner's manual. Otherwise, you risk causing malfunction.



Do not repair or replace parts by yourself

Refer all servicing to your retailer, the nearest Roland Service Center, or an authorized Roland distributor, as listed on the "Information."



⚠ WARNING

Do not use or store in the following types of locations

- Subject to temperature extremes (e.g., direct sunlight in an enclosed vehicle, near a heating duct, on top of heat-generating equipment); or are
- Damp (e.g., baths, washrooms, on wet floors); or are
- Exposed to steam or smoke; or are
- Subject to salt exposure; or are
- Exposed to rain; or are
- Dusty or sandy; or are
- Subject to high levels of vibration and shakiness.

Do not place in an unstable location

Otherwise, you risk injury as the result of the unit toppling over or dropping down.



Connect the power cord to an outlet of the correct voltage

The unit should be connected to a power supply only of the type described as marked on the rear side of unit.



Connect only specified devices to LAMP connector

Connect only compatible lamps to the LAMP connectors.



Use only the supplied power cord

Use only the attached power cord. Also, the supplied power cord must not be used with any other device.



Do not bend the power cord or place heavy objects on it

Otherwise, fire or electric shock may result.



⚠ WARNING

Avoid extended use at high volume

Use of the unit at high volume for extended periods of time may cause hearing loss. If you ever experience any hearing loss or ringing in the ears, you should immediately stop using the unit and consult a specialized physician.



Do not allow foreign objects or liquids to enter unit; never place containers with liquid on unit

Do not place containers containing liquid (e.g., flower vases) on this product. Never allow foreign objects (e.g., flammable objects, coins, wires) or liquids (e.g., water or juice) to enter this product. Doing so may cause short circuits, faulty operation, or other malfunctions.



Turn off the unit if an abnormality or malfunction occurs

Immediately turn the unit off, remove the power cord from the outlet, and request servicing by your retailer, the nearest Roland Service Center, or an authorized Roland distributor, as listed on the "Information" when:



- The power cord has been damaged; or
- If smoke or unusual odor occurs; or
- Objects have fallen into, or liquid has been spilled onto the unit; or
- The unit has been exposed to rain (or otherwise has become wet); or
- The unit does not appear to operate normally or exhibits a marked change in performance.

Be cautious to protect children from injury

Always make sure that an adult is on hand to provide supervision and guidance when using the unit in places where children are present, or when a child will be using the unit.



Do not drop or subject to strong impact

Otherwise, you risk causing damage or malfunction.



WARNING

Do not share an outlet with an unreasonable number of other devices

Otherwise, you risk overheating or fire.



Do not use overseas

Before using the unit in overseas, consult with your retailer, the nearest Roland Service Center, or an authorized Roland distributor, as listed on the "Information."



Handle lithium batteries carefully

- Lithium batteries must never be recharged, heated, taken apart, or thrown into a fire or water.
- Keep lithium batteries out of reach of small children. If a child has accidentally swallowed a battery, see a doctor immediately.
- Never expose lithium batteries to excessive heat such as sunshine, fire or the like.



Turn the unit off before installing expansion interface

Before installing the expansion interface (option), you must first always turn off the unit and unplug its power cord.



CAUTION

When disconnecting the power cord, grasp it by the plug

To prevent conductor damage, always grasp the power cord by its plug when disconnecting it from this unit or from a power outlet.



Periodically clean the power plug

An accumulation of dust or foreign objects between the power plug and the power outlet can lead to fire or electric shock.



At regular intervals, be sure to pull out the power plug, and using a dry cloth, wipe away any dust or foreign objects that may have accumulated.

Disconnect the power plug whenever the unit will not be used for an extended period of time

Fire may result in the unlikely event that a breakdown occurs.



Route all power cords and cables in such a way as to prevent them from getting entangled

Injury could result if someone were to trip on a cable and cause the unit to fall or topple.



Avoid climbing on top of the unit, or placing heavy objects on it

Otherwise, you risk injury as the result of the unit toppling over or dropping down.



Never connect/disconnect a power plug if your hands are wet

Otherwise, you could receive an electric shock.



Cautions when moving this unit

Since this product is very heavy, you must make sure that a sufficient number of people are on hand to help, so you can lift and move it safely, without causing strain. Make sure to have a firm grip, to protect yourself from injury and the instrument from damage. If you need to move the instrument, take note of the precautions listed below.



- Disconnect the power cord.
- Disconnect all cords coming from external devices.

Before cleaning the unit, disconnect the power plug from the outlet

If the power plug is not removed from the outlet, you risk receiving an electric shock.



Whenever there is a threat of lightning, disconnect the power plug from the outlet

If the power plug is not removed from the outlet, you risk receiving an electric shock.



CAUTION

Handle lithium batteries carefully

- Use only the specified type (model no. CR2032) of lithium batteries (p. 22). Be sure to insert it as directed (to ensure correct polarity).
- Used lithium batteries must be disposed of in compliance with whatever regulations for their safe disposal that may be observed in the region in which you live.



Install only specified expansion interface

Install only the specified expansion interface. Remove only the specified screws (p. 24).



Keep small items out of the reach of children

To prevent accidental ingestion of the parts listed below, always keep them out of the reach of small children.



- Included Parts
 - Ferrite core (p. 15)
 - REAC connector cover (p. 16)
- Removable Parts
 - REAC cap (p. 16)
 - USB cover (p. 15)
 - Screws

Handle the ground terminal carefully

If you remove the screw from the ground terminal, be sure to replace it; don't leave it lying around where it could accidentally be swallowed by small children. When refastening the screw, make that it is firmly fastened, so it won't come loose.





Precautions concerning use of phantom power supply

Always turn the phantom power off when connecting any device other than condenser microphones that require phantom power. You risk causing damage if you mistakenly supply phantom power to dynamic microphones, audio playback devices, or other devices that don't require such power. Be sure to check the specifications of any microphone you intend to use by referring to the manual that came with it. (This instrument's phantom power: DC+48 V, 14 mA Max)





INSTRUCTIONS POUR LA PRÉVENTION DES INCENDIES, CHOCS ÉLECTRIQUES OU BLESSURES

À propos des mentions ⚠ AVERTISSEMENT
et ⚡ ATTENTION

 AVERTISSEMENT	Utilisé pour avertir l'utilisateur d'un risque de décès ou de blessure grave en cas de mauvaise utilisation de l'appareil.
 ATTENTION	Utilisé pour avertir l'utilisateur d'un risque de blessure ou de dommage matériel en cas de mauvaise utilisation de l'appareil. * Par dommage matériel, il est entendu les dommages ou tout autre effet indésirable sur la maison et tous ses meubles ainsi que les animaux domestiques ou familiers.

À propos des symboles

	Le symbole ⚠ alerte l'utilisateur d'instructions importantes ou de mise en garde. La signification du symbole est déterminée par ce que contient le triangle. Dans le cas du symbole de gauche, il sert pour des précautions générales, des mises en garde ou alertes vis-à-vis d'un danger.
	Le symbole ⚡ prévient l'utilisateur des choses à ne pas faire (des interdits). Ce qui ne doit spécifiquement pas être fait est indiqué dans le cercle. Dans le cas du symbole de gauche, cela signifie que l'appareil ne doit jamais être démonté.
	Le symbole ● alerte l'utilisateur des choses à faire. Ce qui doit être fait est indiqué par l'icône contenue dans le cercle. Dans le cas du symbole de gauche, cela signifie que le cordon d'alimentation doit être débranché de la prise murale.

PROCÉDEZ TOUJOURS COMME SUIV

AVERTISSEMENT

S'assurer que le cordon d'alimentation est bien mis à la terre

Connectez la fiche secteur de ce modèle à une prise de courant dotée d'une protection par mise à la terre.



Pour éteindre complètement l'alimentation de l'appareil, retirer la fiche de la prise

Même avec son interrupteur d'alimentation hors tension, le M-5000 n'est pas complètement isolé de sa source principale d'alimentation. Lorsque l'alimentation doit être complètement coupée, éteignez l'interrupteur d'alimentation du M-5000 ainsi que de toute autre unité d'alimentation de secours reliée au connecteur EXT. POWER DC INPUT, puis retirez la fiche du M-5000 de la prise. Pour ce faire, branchez le cordon d'alimentation à une prise de courant aussi proche que possible du M-5000 et immédiatement accessible.



Ménager un espace suffisant à l'emplacement d'installation

Comme l'appareil émet normalement une faible quantité de chaleur, assurez-vous de ménager suffisamment d'espace autour de lui, comme indiqué ci-dessous.

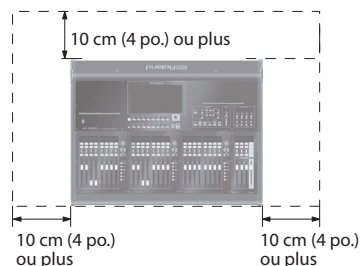

Ne jamais démonter ou modifier vous-même

Ne jamais effectuer une quelconque opération, sauf si vous êtes invité à le faire dans le mode d'emploi. Sinon, vous risquez de provoquer des dysfonctionnements.



Ne pas réparer ou remplacer de pièces par vous-même

Confiez toute réparation à votre revendeur, le centre Roland le plus proche ou un distributeur Roland agréé, comme indiqué dans les "Informations".



AVERTISSEMENT

Ne jamais ranger ou utiliser dans des endroits :

- Soumis à des températures extrêmes (ex : en plein soleil dans un véhicule fermé, à proximité d'une conduite de chauffage, au-dessus de matériel générateur de chaleur),
- humides (ex : salles de bain, toilettes, sur des sols mouillés), ou
- exposés à de la vapeur ou de la fumée, ou
- exposés au sel, ou
- exposés aux précipitations, ou
- poussiéreux ou sableux, ou
- soumis à de fortes vibrations et secousses.



Ne pas placer à un endroit instable

Sinon, vous risquez des blessures si l'appareil se renverse ou tombe.



Brancher le cordon d'alimentation à une prise d'une tension correcte

L'appareil doit être connecté uniquement à une source d'alimentation du type indiqué sur la face arrière de l'appareil.



Connecter uniquement des périphériques spécifiés au connecteur LAMP

Connectez uniquement des lampes compatibles aux connecteurs LAMP.



Utiliser uniquement le cordon d'alimentation fourni

Utilisez uniquement le cordon d'alimentation fourni. En outre, le cordon d'alimentation fourni ne doit pas être utilisé avec un tout autre appareil.



Ne pas plier le cordon d'alimentation ou déposer d'objets lourds sur celui-ci

Sinon, cela risque de provoquer un incendie ou un choc électrique.



AVERTISSEMENT

Éviter l'utilisation prolongée à un volume élevé

L'utilisation de l'appareil à un volume élevé pendant des périodes prolongées peut entraîner une perte auditive. Si jamais vous ressentez une perte auditive ou des bourdonnements dans les oreilles, veuillez immédiatement cesser d'utiliser l'appareil et consultez un médecin spécialisé.



Ne jamais laisser de corps étrangers ou de liquides pénétrer dans l'appareil et ne jamais placer de récipients contenant un liquide sur l'appareil

Ne jamais placer de récipients contenant du liquide (ex : vases de fleurs) sur ce produit. Ne jamais laisser des corps étrangers (ex : objets inflammables, pièces, fils) ou des liquides (ex : eau, jus de fruit) pénétrer à l'intérieur du produit. Vous risqueriez de provoquer des courts-circuits, pannes ou autres dysfonctionnements.



Eteindre l'appareil en cas d'anomalie ou de dysfonctionnement

Mettez immédiatement l'appareil hors tension, débranchez le cordon d'alimentation de la prise et contactez votre revendeur, le centre Roland le plus proche ou un distributeur Roland agréé, comme indiqué dans les "Informations" lorsque :



- Le cordon d'alimentation a été endommagé, ou
- en présence de fumée ou odeur inhabituelle, ou
- des objets sont tombés dans ou du liquide a été renversé dans l'appareil, ou
- l'appareil a été exposé à la pluie (ou a été mouillé), ou
- l'appareil ne semble pas fonctionner normalement ou présente un changement notable de ses performances.

Veiller à ce que les enfants ne se blessent pas

Veillez à ce qu'un adulte assure toujours une surveillance et un accompagnement lorsque l'unité est utilisée en présence d'enfants ou par un enfant.



Ne pas faire tomber ou soumettre à des chocs violents

Sinon, vous risquez de provoquer des dommages ou des dysfonctionnements.



AVERTISSEMENT

Ne pas partager une prise murale avec un nombre excessif d'autres appareils

Sinon, vous risquez une surchauffe ou un incendie.



Ne pas utiliser à l'étranger

Avant d'utiliser l'appareil à l'étranger, consultez votre revendeur, un centre Roland ou un distributeur Roland agréé, comme indiqué dans les "informations".



Manipulez les piles au lithium avec précaution

- Les piles au lithium ne doivent jamais être rechargées, chauffées, démontées ou jetées au feu ou à l'eau.
- Maintenez les piles au lithium hors de portée des enfants en bas âge. Si un enfant a accidentellement avalé une pile, consultez immédiatement un médecin.
- N'exposez jamais les piles à une forte chaleur (ensoleillement direct ou feu, par exemple).



Eteindre l'appareil avant d'installer l'interface d'extension

Avant d'installer l'interface d'extension (en option), vous devez d'abord toujours éteindre l'appareil et débrancher le cordon d'alimentation.



ATTENTION

Lorsque vous débranchez le cordon d'alimentation, saisissez-le par la fiche

Pour éviter d'endommager le conducteur, toujours saisir le cordon d'alimentation par sa fiche lorsque vous le débranchez de l'appareil ou d'une prise de courant.



Nettoyer régulièrement le cordon d'alimentation

Une accumulation de poussière ou de corps étrangers entre la fiche d'alimentation et la prise de courant peut provoquer un incendie ou un choc électrique.



A intervalles réguliers, assurez-vous de débrancher la prise d'alimentation, et à l'aide d'un chiffon sec, essuyez la poussière ou les corps étrangers qui ont pu s'y accumuler.

Débrancher le cordon d'alimentation lorsque l'appareil n'est pas utilisé pendant une longue période

Un incendie peut se produire dans le cas fortuit où une panne survient.



Acheminer tous les cordons d'alimentation et câbles de façon à ce qu'ils ne puissent pas s'emmêler

Des blessures peuvent survenir si quelqu'un vient à trébucher sur un câble et provoque la chute ou le basculement de l'appareil.



Ne pas grimper sur l'appareil ou y poser des objets lourds

Sinon, vous risquez des blessures suite à la chute ou au basculement de l'appareil.



Ne jamais brancher/débrancher un cordon d'alimentation lorsque vous avez les mains mouillées

Sinon, vous pourriez subir un choc électrique.



Précautions à prendre si vous déplacez l'appareil

Comme ce produit est très lourd, vous devez vous assurer qu'un nombre suffisant de personnes sont là pour vous aider afin de le soulever et de le déplacer en toute sécurité, sans causer de surcharge. Assurez-vous d'avoir une bonne prise afin d'éviter de vous blesser ou d'endommager l'instrument. Si vous devez déplacer l'instrument, veuillez respecter les précautions énumérées ci-dessous.



- Débranchez le cordon d'alimentation.
- Débranchez tous les cordons provenant de dispositifs externes.

Avant de nettoyer l'appareil, débrancher le cordon d'alimentation de la prise

Si la fiche d'alimentation n'est pas débranchée de la prise, vous risquez de subir un choc électrique.



Chaque fois qu'il y a un risque de foudre, débrancher le cordon d'alimentation de la prise

Si la fiche d'alimentation n'est pas débranchée de la prise, vous risquez de subir un choc électrique.



ATTENTION

Manipulez les piles au lithium avec précaution

- N'utilisez que le type de piles au lithium spécifié (modèle n°CR2032) (p. 23). Assurez-vous de les insérer en respectant les instructions (pour que la polarité soit correcte).
- Les piles au lithium usagées doivent être mises au rebut conformément à la réglementation en vigueur dans la région où vous résidez.



Installer uniquement l'interface d'extension indiquée

Installez uniquement l'interface d'extension indiquée.

Retirer seulement les vis indiquées (p. 25).



Tenez les pièces de petite taille hors de portée des enfants en bas âge

Pour éviter toute ingestion accidentelle des pièces indiquées ci-dessous, tenez-les toujours hors de portée des enfants en bas âge.



- Composants inclus
 - Noyau de ferrite (p. 15)
 - Cache du connecteur REAC (p. 17)
- Pièces amovibles
 - Bouchon REAC (p. 17)
 - Cache USB (p. 15)
 - Vis

Manipulez avec précaution la prise de terre

Si vous retirez la vis de la prise de terre, assurez-vous de la remettre en place. Ne laissez traîner aucune pièce pour éviter qu'un jeune enfant ne l'ingère par accident. Lorsque vous remontez la vis, veillez à la resserrer fermement pour éviter qu'elle ne se détache.



Précautions concernant l'utilisation de l'alimentation fantôme

Toujours éteindre l'alimentation fantôme avant de brancher tout autre appareil qu'un microphone à condensateur nécessitant une alimentation fantôme. Vous risquez de provoquer des dommages si vous fournissez à tort une alimentation fantôme à des micros dynamiques, des appareils de lecture audio ou d'autres appareils qui ne nécessitent pas une telle alimentation. Assurez-vous de vérifier les spécifications de tout microphone que vous souhaitez utiliser en vous référant au manuel qui l'accompagne.
(Alimentation fantôme de cet instrument : DC+48 V, 14 mA Max)



IMPORTANT NOTES

Power Supply

- Do not connect this unit to same electrical outlet that is being used by an electrical appliance that is controlled by an inverter or a motor (such as a refrigerator, washing machine, microwave oven, or air conditioner). Depending on the way in which the electrical appliance is used, power supply noise may cause this unit to malfunction or may produce audible noise. If it is not practical to use a separate electrical outlet, connect a power supply noise filter between this unit and the electrical outlet.

Placement

- Using the unit near power amplifiers (or other equipment containing large power transformers) may induce hum. To alleviate the problem, change the orientation of this unit; or move it farther away from the source of interference.
- This unit may interfere with radio and television reception. Do not use this unit in the vicinity of such receivers.
- Noise may be produced if wireless communications devices, such as cell phones, are operated in the vicinity of this unit. Such noise could occur when receiving or initiating a call, or while conversing. Should you experience such problems, you should relocate such wireless devices so they are at a greater distance from this unit, or switch them off.
- When moved from one location to another where the temperature and/or humidity is very different, water droplets (condensation) may form inside the unit. Damage or malfunction may result if you attempt to use the unit in this condition. Therefore, before using the unit, you must allow it to stand for several hours, until the condensation has completely evaporated.
- Depending on the material and temperature of the surface on which you place the unit, its rubber feet may discolor or mar the surface. You can place a piece of felt or cloth under the rubber feet to prevent this from happening. If you do so, please make sure that the unit will not slip or move accidentally.
- Do not place containers or anything else containing liquid on top of this unit. Also, whenever any liquid has been spilled on the surface of this unit, be sure to promptly wipe it away using a soft, dry cloth.

Maintenance

- Never use benzene, thinners, alcohol or solvents of any kind, to avoid the possibility of discoloration and/or deformation.

Repairs and Data

- Before sending the unit away for repairs, be sure to make a backup of the data stored within it; or you may prefer to write down the needed information. Although we will do our utmost to preserve the data stored in your unit when we carry out repairs, in some cases, such as when the memory section is physically damaged, restoration of the stored content may be impossible. Roland assumes no liability concerning the restoration of any stored content that has been lost.

Memory Backup

- This unit contains a battery which powers the unit's memory circuits while the main power is off. When this battery becomes weak, the message shown below will appear in the display. Once you see this message, have the battery replaced with a fresh one as soon as possible to avoid the loss of all data in memory.

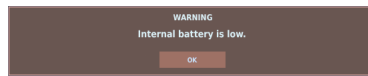

Additional Precautions

- Any data stored within the unit can be lost as the result of equipment failure, incorrect operation, etc. To protect yourself against the irretrievable loss of data, try to make a habit of creating regular backups of the data you've stored in the unit.
 - Roland assumes no liability concerning the restoration of any stored content that has been lost.
 - Use a reasonable amount of care when using the unit's buttons, sliders, or other controls; and when using its jacks and connectors. Rough handling can lead to malfunctions.
 - Never strike or apply strong pressure to the display.
 - When disconnecting all cables, grasp the connector itself—never pull on the cable. This way you will avoid causing shorts, or damage to the cable's internal elements.
 - A small amount of heat will radiate from the unit during normal operation.
 - To avoid disturbing others nearby, try to keep the unit's volume at reasonable levels.
- This product is using the open source license (GPL/LGPL) software. You have the right to acquire, modify and distribute the source code for this open source license software. You can obtain the open source license source code used in this product by downloading it from the following website: URL:<http://www.roland.com/support/gpl/>
 - This product contains eParts integrated software platform of eSOL Co.,Ltd. eParts is a trademark of eSOL Co., Ltd. in Japan.
 - "Made for iPod," means that an electronic accessory has been designed to connect specifically to iPad and has been certified by the developer to meet Apple performance standards. Apple is not responsible for the operation of this device or its compliance with safety and regulatory standards. Please note that the use of this accessory with iPad may affect wireless performance. Apple, Macintosh, Mac OS, iPad are either registered trademarks or trademarks of Apple Inc.
 - Roland, REAC are either registered trademarks or trademarks of Roland Corporation in the United States and/or other countries.
 - Company names and product names appearing in this document are registered trademarks or trademarks of their respective owners.

Using External Memories

- Please observe the following precautions when handling external memory devices. Also, make sure to carefully observe all the precautions that were supplied with the external memory device.
 - Do not remove the device while reading/writing is in progress.
 - To prevent damage from static electricity, discharge all static electricity from your person before handling the device.

Intellectual Property Right

- It is forbidden by law to make an audio recording, video recording, copy or revision of a third party's copyrighted work (musical work, video work, broadcast, live performance, or other work), whether in whole or in part, and distribute, sell, lease, perform, or broadcast it without the permission of the copyright owner.
- Do not use this product for purposes that could infringe on a copyright held by a third party. We assume no responsibility whatsoever with regard to any infringements of third-party copyrights arising through your use of this product.
- MMP (Moore Microprocessor Portfolio) refers to a patent portfolio concerned with microprocessor architecture, which was developed by Technology Properties Limited (TPL). Roland has licensed this technology from the TPL Group.
- ASIO is a trademark and software of Steinberg Media Technologies GmbH.
- This product is using the open source license (GPL/LGPL) software. You have the right to acquire, modify and distribute the source code for this open source license software. You can obtain the open source license source code used in this product by downloading it from the following website: URL:<http://www.roland.com/support/gpl/>
- This product contains eParts integrated software platform of eSOL Co.,Ltd. eParts is a trademark of eSOL Co., Ltd. in Japan.
- "Made for iPod," means that an electronic accessory has been designed to connect specifically to iPad and has been certified by the developer to meet Apple performance standards. Apple is not responsible for the operation of this device or its compliance with safety and regulatory standards. Please note that the use of this accessory with iPad may affect wireless performance. Apple, Macintosh, Mac OS, iPad are either registered trademarks or trademarks of Apple Inc.
- Roland, REAC are either registered trademarks or trademarks of Roland Corporation in the United States and/or other countries.
- Company names and product names appearing in this document are registered trademarks or trademarks of their respective owners.

About the Documentation

Before using this unit, carefully read the sections entitled "IMPORTANT SAFETY INSTRUCTIONS" (p. 2), "USING THE UNIT SAFELY" (p. 4), and "IMPORTANT NOTES" (p. 8). After reading, keep the document(s) including those sections where it will be available for immediate reference.

The explanations in this manual include illustrations that depict what should typically be shown by the display. Note, however, that your unit may incorporate a newer, enhanced version of the system (e.g., includes newer sounds), so what you actually see in the display may not always match what appears in the manual.

This manual describes the basic matters and basic operation of the M-5000 and M-5000C live mixing consoles.

In descriptions of matters and operation procedures that are common to both the M-5000 and M-5000C, the two models are referred to collectively as "the M-5000."

Matters that are specific to only one or the other model are indicated by "M-5000 only" or "M-5000C only."

When "the M-5000 is depicted" or the like is noted, the description uses the M-5000 as representative of both the M-5000 and the M-5000C.

French language

for Canadian Safety Standard

Ce manuel décrit les éléments de base et le fonctionnement de base des consoles de mixage en direct M-5000 et M-5000C.

Dans les descriptions des éléments et des procédures de fonctionnement qui sont communs à la fois au M-5000 et au M-5000C, les deux modèles sont désignés collectivement sous le terme « le M-5000. »

Les éléments qui concernent spécifiquement l'un ou l'autre modèle sont indiqués par le terme « M-5000 uniquement » ou « M-5000C seulement ».

Lorsque « le M-5000 est décrit » ou toute mention similaire apparaît, la description se réfère au M-5000 pour présenter à la fois le M-5000 et le M-5000C.

Organization of the Documentation

The documentation for this unit is organized as follows.

Quick Start (this document)

This describes the basic matters and procedures necessary for unit operation and quick startup.

Reference Manual (PDF)

This adds to the information in Quick Start by describing the operational features on the various screens and other detailed usage methods.

RCS User's Guide (PDF)

This describes how to use the M-5000 RCS dedicated remote-control software that runs under Windows or on a Macintosh computer.

Remote User's Guide (PDF)

This describes how to use the M-5000 Remote dedicated remote-control software that runs on an iPad.

Telnet Reference Manual (PDF)

This describes how to control the M-5000 over a local area network (TCP/IP protocol), using Telnet.

MIDI Implementation (PDF)

This describes the MIDI messages that the M-5000 supports.

RS-232C Reference Manual (PDF)

This describes the RS-232C interface commands that the M-5000 supports.

The PDF-format versions of documentation can be downloaded from the Roland website.

Contents

IMPORTANT SAFETY INSTRUCTIONS	2
INSTRUCTIONS IMPORTANTES DE SÉCURITÉ	3
French language for Canadian Safety Standard	
USING THE UNIT SAFELY	4
CONSIGNES DE SÉCURITÉ	6
French language for Canadian Safety Standard	
IMPORTANT NOTES	8
About the Documentation	9
Main Features	12
Placement and Setup	15
Included Items	15
Attaching the Ferrite Cores	15
Detaching the USB cover (M-5000C only)	15
Detaching the REAC Caps	16
Attaching the REAC Connector Covers	16
Connecting the Power Cord	16
Using the Power-cord Clamp	16
Using the Power-cord Hook	18
Connecting Backup Power to the M-5000	18
Disconnecting Backup Power	20
Turning the Power On and Off	20
Turning the Power On	20
Turning the Power Off	20
Replacing the Internal Lithium Battery	22
Attaching the Tablet Sheets	22
Installing an Expansion Interface (Option)	24
Using the LAN-cable Hook	24
French language for Canadian Safety Standard	
Retrait des caches REAC	17
Fixation des couvercles connecteur REAC	17
Connexion du cordon d'alimentation	17
Utilisation de l'attache du cordon d'alimentation	17
Utilisation du Crochet du cordon d'alimentation	19
Raccordement d'une alimentation de secours au M-5000	19
Déconnexion de l'alimentation de secours	21
Mise sous tension et hors tension de l'appareil	21
Mise hors tension	21
Mise sous tension	21
Remplacement de la pile au lithium interne	23
Fixation des housses de tablette	23
Installation d'une interface d'extension (en option)	25
Utilisation du crochet de câble réseau	25
Installing REAC Devices	26
Basic REAC Knowledge	26
About Cables	26
Ethernet Cable Types	26
Ethernet Connectors	26
Important Notes on Handling Ethernet Cables	26
Connecting REAC Input/Output Units	27
Important Notes on REAC Connections	27
Part Names and Functions	28
Top Panel	28
Fader Bank Section	30
Assignable Fader Section	31
USB MEMORY Connector	31
Display Section	32
Monitor Section	33
Scene Section	34
Recorder Section	34
Talkback Section	35
User-assignable Section	36
Rear Panel	38
Front Panel	44
French language for Canadian Safety Standard	
Panneau arrière	39
Panneau avant	45
Overview of Operations	46
Fader Bank Section	46
Layers	46
Scrolling	46
Basic Operations of Fader Bank Section	46
Changing Layers	46
Scrolling the Channels	46
Anchor Channels	47
Accessing an Anchor Channel (Anchor Jump)	47
Accessing Adjacent Anchor Channels	47
Isolated Banks	48
Isolating a Fader Bank	48
Unisolating a Fader Bank	48
Basic Touch Operations	49
Using Templates to Select a Mixer Configuration	49
HOME Screen	50
Access the CH EDIT window	50
Selecting the Source for an Input Channel	51
Selecting the Destination for an Output Bus	51
Turning Phantom Power On or Off	52
Adjusting the Preamp Gain	52
Applying Dynamics	53
Applying EQ	53
Using Faders to Adjust the Send Level to AUX (SENDS ON FADER)	53
Sending to SUBGROUP/MIX-MINUS	54
Using an FX with Send/Return	54
Inserting an FX	55
Inserting a GEQ	56
Linking Channels	57
Making Assignments to DCA/MUTE Groups	58
Using Talkback	58
Using the Oscillators	59

Scene memory	59
Creating New Scenes and Adding Scenes	59
Storing a Scene (by Overwriting)	59
Recalling a Scene	60
Recording/Playback to/from a USB Flash Drive	60
WAV File Formats	60
Recording to a USB Flash Drive	60
Playback from a USB Flash Drive	61
Backing Up All Data in the M-5000	61
Saving a Project File to a USB Flash Drive	61
Restoring All Data in the M-5000	62
Loading a Project File from a USB Flash Drive	62
Formatting a USB Flash Drive on the M-5000	62
Muting All Outputs	62
Setting the Date and Time	63
Factory Reset	63
Fader Calibration	63
<hr/>	
Appendix	64
Main specifications	64
Dimensions	66

Main Features

The M-5000 is Roland's next-generation flagship mixing console, featuring an ideal user interface for operating a 96-kHz mixing engine loaded with original Roland technology.

The M-5000 can flexibly transform its configuration and functions to accommodate a wide range of situations with its large complement of outstanding features.

The following key words encapsulate the novel technology built into this unit.

"O · H · R · C · A™ = Open High Resolution Configurable Architecture"

Let's take a look at each feature.

Configurable Architecture

The M-5000's mixing engine can freely change its configuration and functions to accommodate the situation. This means it's not definable the M-5000 as a mixer having a specific number of input channels and output buses. For instance, it can become an FOH mixer with 100 input channels at one time, and a monitor mixer having 60 output buses at another.

How is this incredible flexibility and functionality achieved?

The M-5000 is provided with internal processing power for 128 audio paths. These paths can freely be used as input channels, auxiliary buses, groups, matrices, etc. You, the user, can assign these any way you like. When considering the configuration, keep in mind that talkback, oscillators, monitor speakers, and other such functions also each use up audio paths, and plan accordingly.

Now let's take a look at some actual examples of the kinds of mixer configurations you can achieve with this functionality.

1 Standard

- 75 monaural input channels
- 6 stereo input channels
- Main LR/C
- 24 AUX
- 8 MATRIX
- Monitors, talkback, oscillator, headphones (6 audio paths used)

2 Monitor mix

- 48 monaural input channels
- 8 stereo input channels
- Main LR
- 54 AUX
- Monitors 1 and 2, talkback, oscillator, headphones (8 audio paths used)

3 FOH mix

- 79 monaural input channels
- 8 stereo input channels
- Main LR/C
- 10 subgroups
- 6 AUX
- 8 MATRIX
- Monitors, talkback, oscillator, headphones (6 audio paths used)

4 Broadcast

- 72 monaural input channels
- 6 stereo input channels
- Main 5.1 + stereo downmix (8 audio paths used)
- 8 subgroups
- 8 AUX
- 4 MIX-MINUS
- 8 MATRIX
- Monitors 1 and 2, talkback, oscillator, headphones (8 audio paths used)

So what do you think? It's clear that the M-5000 has an extremely powerful mixing engine.

High Resolution

All elements installed in the M-5000 operate at a sample rate of 96 kHz. Not only AD/DA but the mixing engine as well operate at 96 kHz. All effect algorithms operate at 96kHz.

The analog input and output section that has such a big impact on mixer sound quality, also incorporates Roland expertise with even further refinements. The discrete microphone preamps in the input section has been exclusively designed for 24bit/96kHz operation of the M-5000, enhancing the signal-to-noise ratio for unaffected, high-resolution sound.

Combining these examples of precise analog and digital technology achieves a clarity of sound with an easy naturalness and a sense of high resolution — just what you'd expect a flagship unit to deliver.

Open

The M-5000 is provided with two slots for installing expansion interfaces to expand input and output capability. A variety of formats are supported for installable expansion interfaces, including MADI and Dante as well as REAC, with even more types to be added. Each of these expansion slots provides an additional option of bidirectional input and output on up to 160 channels (when at 48 kHz) or 80 channels (when at 96 kHz), assuring expandability of the M-5000 on into the future.

Channel Strips

The high-functionality channel strips that can operate as either input channels or output buses as we have seen can also modify content. The EQ and dynamics algorithms deliver superb sound quality and reproduce the feel of analog effecters when manipulating parameters. It is also possible to rearrange the sequence of EQ and dynamics applied.

GEQs and Effects

The M-5000 is equipped with 32 31-band graphic equalizers that you can insert in input channels and output buses. You can also select either proportional or constant as the Q type for GEQs as well as switch a GEQ to operate as an 8-band PEQ.

Eight stereo (16 dual-mono) effects are available as well. The high-quality effects provided on Roland mixers have been redesigned to operate at 96 kHz, and operational feel is also improved.

A new "dynamic EQ" effect type has also been added.

REAC

At the core of digital transmission on the M-5000 is Roland's own originally developed REAC (Roland Ethernet Audio Communication) protocol. Roland was among the first to note the usefulness of digital transmission, and announced the first REAC device, the S-4000S Digital Snake, in 2005. Since then, the simplicity of setup and high stability of REAC devices has been acknowledged by acceptance and used around the world. One of the three REAC ports on the M-5000 supports REAC Embedded Power, making it possible to power and communicate with an M-48 personal mixer or S-0808 digital snake over a single LAN cable.

You can also install additional REAC expansion interfaces in the expansion slots described later in this manual.

Super Patchbay

Because digital communication using REAC and expansion using the optional expansion interface are both covered, the M-5000's patchbays are amply powerful on their own.

	When at 96kHz	When at 48kHz
M-5000	300 inputs/296 outputs	460 inputs/456 outputs
M-5000C	300 inputs/288 outputs	460 inputs/448 outputs

With the combinations of input and output ports, and with the ability to incoming signals to output without passing through the mixer core, it is possible to create flexible setups such as for transmission between front of house and monitors or direct out to recorders.

Remote Control

You can use the M-5000 RCS dedicated control program to operate the M-5000 remotely from a Windows or Macintosh computer. You can also remotely control the console from an iPad by using the M-5000 Remote dedicated application.

External Control

With the M-5000's four input and 12 output GP I/O connectors, you can send and receive control signals to and from external devices. The M-5000 also provides four inputs for footswitch pedals.

As with other Roland digital mixers up to now, control via MIDI or the RS-232C interface is also possible.

Live Recording

Connecting a Macintosh or Windows-based computer to the USB COMPUTER connector engages 16x16 recording and playback audio interface that can be used with most digital audio workstation (DAW) software.

Recording and playback of two-channel WAV files on USB flash drives is also available using the USB port on the console surface.

Connecting an R-1000 48-track recorder to the REAC connector lets you carry out 48-track (48 kHz) or 24-track (96 kHz) recording and playback as a standalone device.

Redundancy

Connecting an optional S-240P to the EXT. POWER DC INPUT connector achieves redundant power so if a problem occurs in the M-5000's main power source, backup power is supplied by the S-240P.

Using 2 REAC ports to a digital snake achieves redundant audio transmission.

Ideal User Interface

So far we've taken a look at many of the M-5000's outstanding functions.

A basic rule of design holds that increasing the number of functions generally can have a negative impact on ease of use.

However, the M-5000 shatters this rule by architecting a highly rational user interface using a small number of controls. Let's look at the several sections that make up the M-5000's outstanding user interface.

1 Display section

Nearly all parameters can be manipulated using the touch display with the attractive design and the 16 knobs and switches laid out beneath it. Any parameter you touch on the screen can also be immediately adjusted directly by the one "Selected Knob".

Because operations are completed using just this section, time loss due to large hand movements is minimized.

The high-reliability, pressure-sensitive 12-inch display clearly and vividly displays a variety of information with high image quality and a wide viewing angle.

2 Fader bank section and assignable fader section

The fader bank section, where 8 faders are provided, can also be used as independent sets of 8 faders or as interlinked sets of 16 or 24 faders. The decision on how to use the 24 controls can be made instantly, letting you operate the M-5000 and its huge mixing engine with optimal efficiency. You can also assign often-used input channels and output buses to the four assignable faders and display them on the top panel at all times.

Organic EL displays offering excellent brightness and visibility are provided above both the fader bank section and the assignable fader section, enabling quick checking of information.

3 User-assignable section

Assigning frequently used functions to the user-assignable section lets you display important functions on the top panel at all times. This groups together four encoders and eight switches in a compact layout, but you can assign many more functions to this section by switching between three banks.

Placement and Setup

Included Items

The items included with the M-5000 are as follows. Check to ensure that all are present.

- Power cord
- * Be sure to use only the power cord included with the M-5000.
- REAC connector covers (3)
- Ferrite cores (6)
- Quick Start (this document)
- Cover
- Dock cable
- Tablet sheets (2: M-5000 only, 1: M-5000C only)

If any included item is missing, contact the nearest Roland Service Center.

Attaching the Ferrite Cores

Before you use the M-5000, be sure to attach ferrite cores to any cables connected to the following connectors.

- REAC ports (A, B, SPLIT/BACKUP)
- LAN port
- AES/EBU OUT 1/2, AES/EBU OUT 3/4 jacks

The ferrite cores are intended to counter electromagnetic noise. Leave them attached at all times.

1. Spread open the tabs and open the ferrite core.

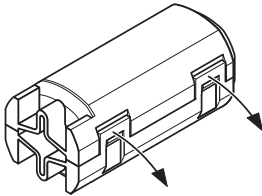

2. Attach the ferrite core at a location near the plug base.

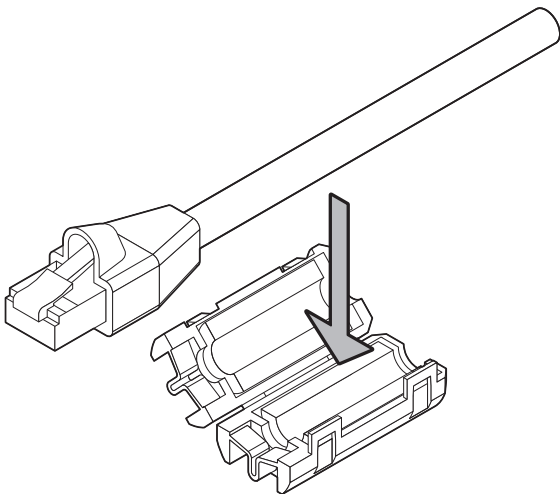

3. Close the ferrite core by pressing down until it snaps into place with an audible click.

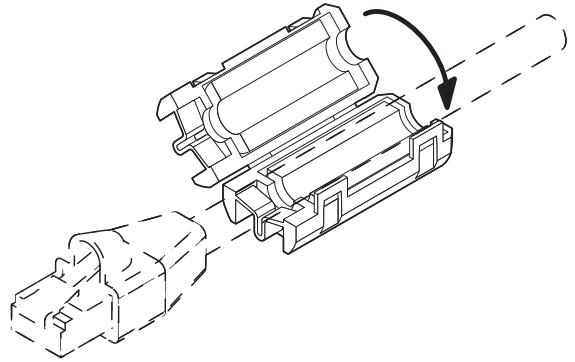

4. Connect the plug at the end where the ferrite core is attached to the unit.

Detaching the USB cover (M-5000C only)

When the M-5000C is shipped, a USB cover is attached to the USB MEMORY connector. Remove the USB cover when using USB flash drive.

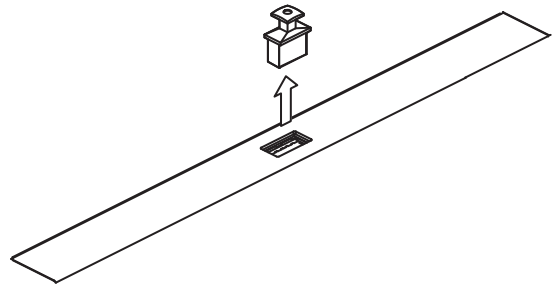

Detaching the REAC Caps

By default, the REAC ports are fitted with REAC caps. Remove these REAC caps when you use the REAC ports. Be careful not to lose the removed REAC caps so you can insert them again when transporting or when the port(s) are not in use.

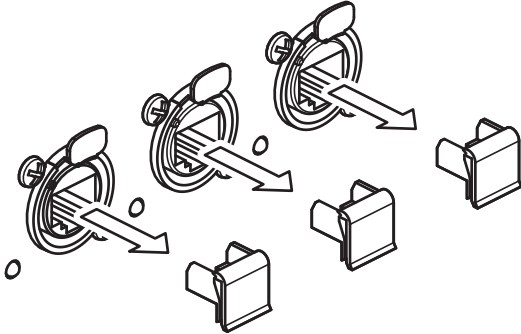

Attaching the REAC Connector Covers

When using commercially available Category 5e Ethernet cables, attach the included REAC connector covers.

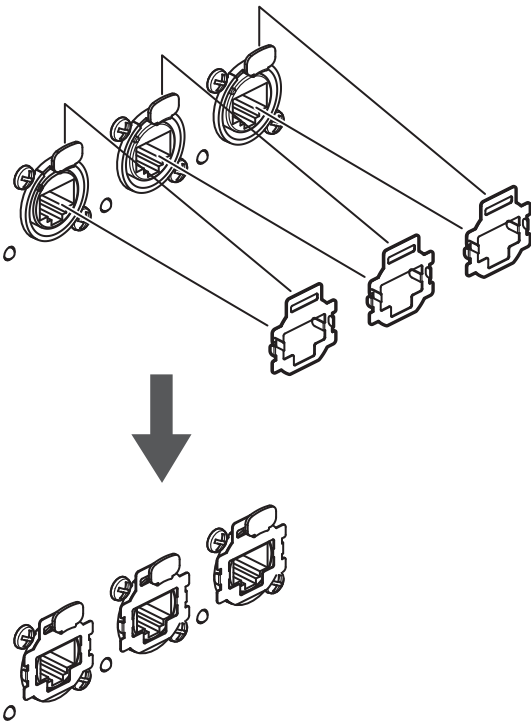

MEMO

Remove the REAC connector covers when using EtherCon type REAC cables (SC-W20F, SC-W100S, or W100S-R). Be careful to keep removed REAC connector covers from becoming lost.

Connecting the Power Cord

NOTE

Be sure to use the included power cord for connecting the power supply.

1. Connect the included power cord to the AC IN connector on the rear panel.

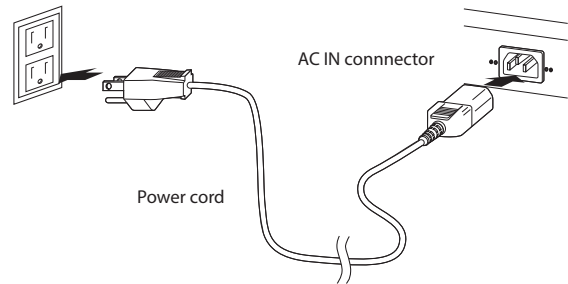

* The shape of the power cord's plug varies depending on the country.

Using the Power-cord Clamp

Lower the power-cord clamp as shown in the figure to secure the power cord's plug in place.

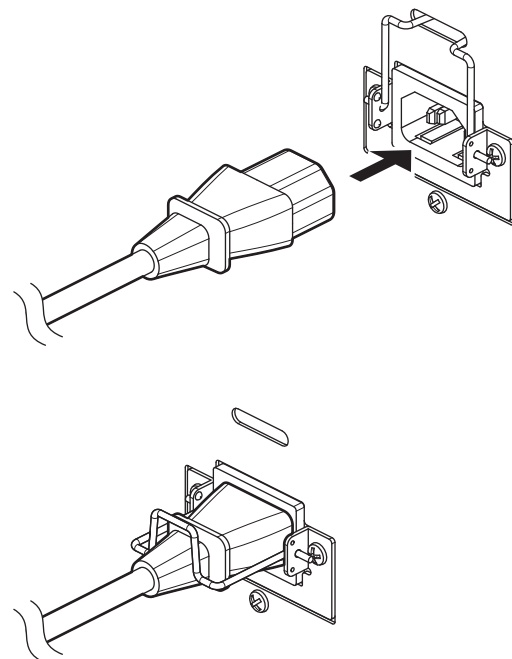

Retrait des caches REAC

Par défaut, les ports REAC sont pourvus de caches REAC. Retirez ces caches REAC lorsque vous utilisez les ports REAC. Veillez à ne pas égarer les caches REAC qui ont été retirés.

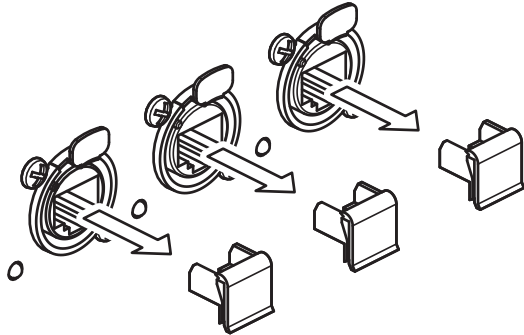

Fixation des couvercles connecteur REAC

Lors de l'utilisation de câbles Ethernet de catégorie 5e disponibles dans le commerce, fixer les couvercles connecteur REAC inclus.

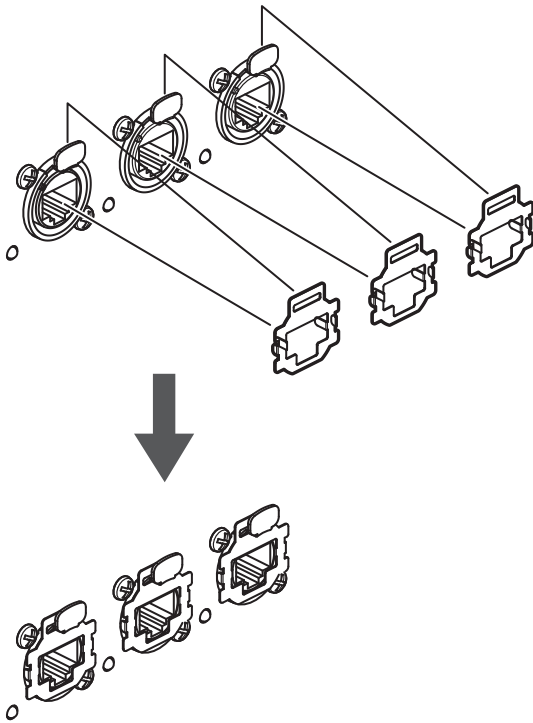

NOTE

Retirez les couvercles connecteur REAC lors de l'utilisation de câbles REAC de type EtherCon (SC-W20F, SC-W100S ou W100S-R). Veillez à ne pas égarer les couvercles connecteur REAC qui ont été retirés.

Connexion du cordon d'alimentation

NOTE

Veillez à utiliser le cordon d'alimentation fourni pour brancher l'alimentation.

1. Brancher le cordon d'alimentation fourni à la prise AC IN sur le panneau arrière.

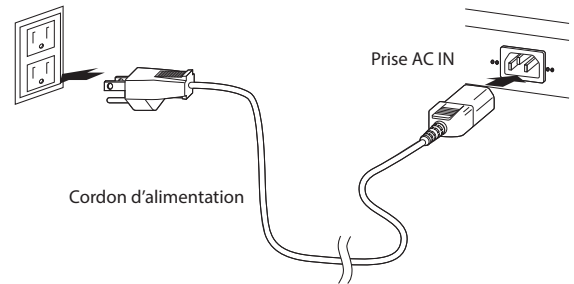

* La forme de la fiche du cordon d'alimentation varie selon les pays.

Utilisation de l'attache du cordon d'alimentation

Abaisser l'attache du cordon d'alimentation comme indiqué sur la figure pour fixer la fiche du cordon d'alimentation en place.

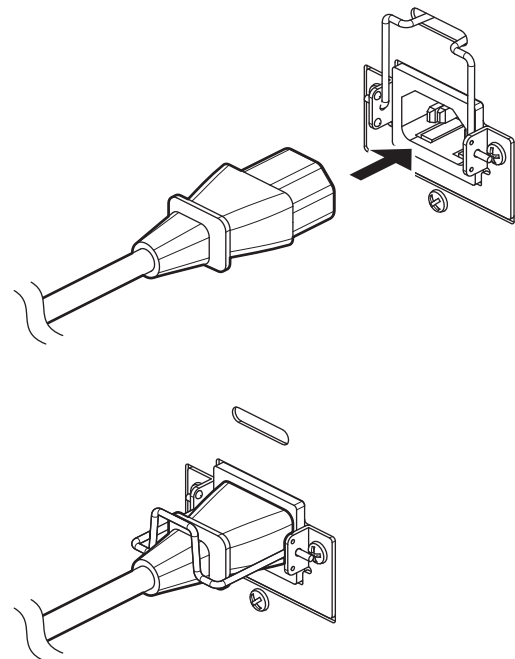

Using the Power-cord Hook

Engage the power cord on the power-cord hook as shown in the figure to secure the power cord in place.

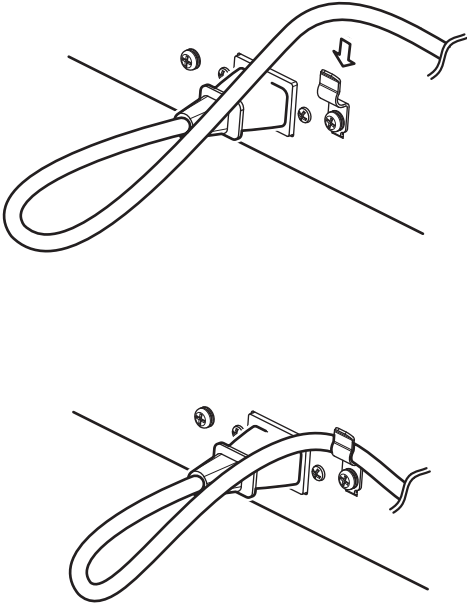

Connecting Backup Power to the M-5000

You can connect an adapter cable to the DC OUTPUT plug on an optional S-240P unit, and connect that to the EXT. POWER DC INPUT connector on the M-5000.

For information on the adapter cable used for connection to the DC OUTPUT plug, consult your Roland vendor.

1. Insert the DC OUTPUT plug on the S-240P into the adapter cable (Speakon end).

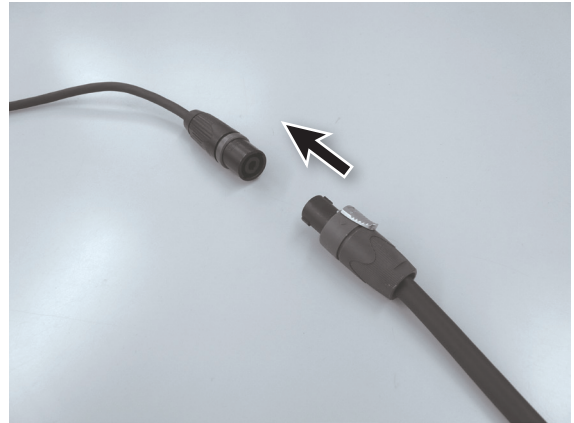

2. Twist the S-240P's DC OUTPUT plug clockwise until you hear it click.

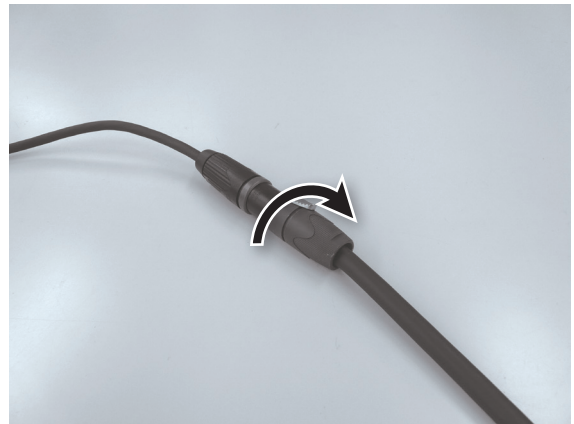

3. Insert the adapter cable (XLR4 end) into the EXT. POWER DC INPUT connector on the M-5000 until you hear it click.

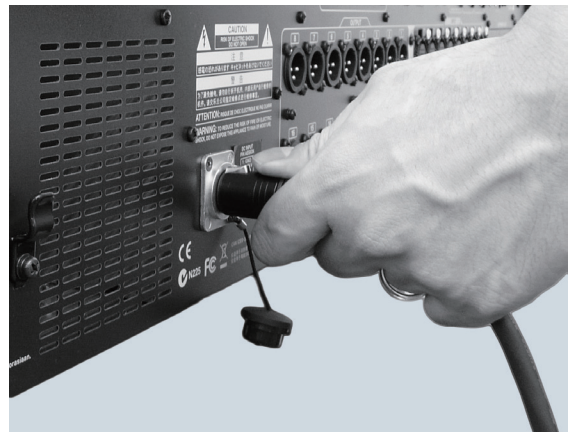

Utilisation du Crochet du cordon d'alimentation

Engager le cordon d'alimentation sur le Crochet du cordon d'alimentation comme indiqué sur la figure pour fixer le cordon d'alimentation en place.

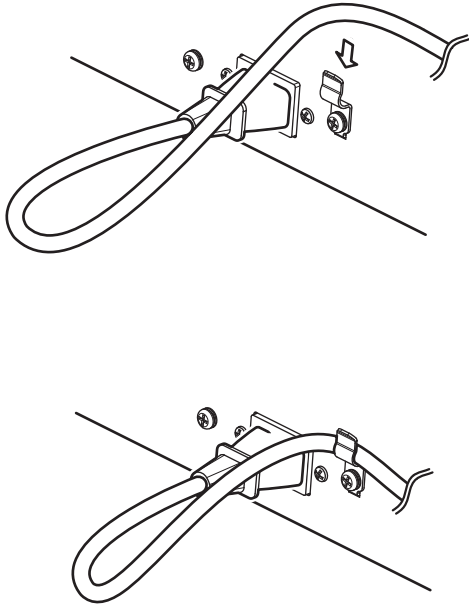

Raccordement d'une alimentation de secours au M-5000

Vous pouvez connecter un câble d'adaptateur à la prise DC OUTPUT d'une unité S-240P optionnelle et le raccorder au connecteur EXT. POWER DC INPUT du M-5000.

Pour plus d'informations sur le câble d'adaptateur utilisé pour la connexion à la prise DC OUTPUT, consultez votre fournisseur Roland.

1. Insérer la fiche DC OUTPUT sur le S-240P dans le câble de l'adaptateur (extrémité Speakon).

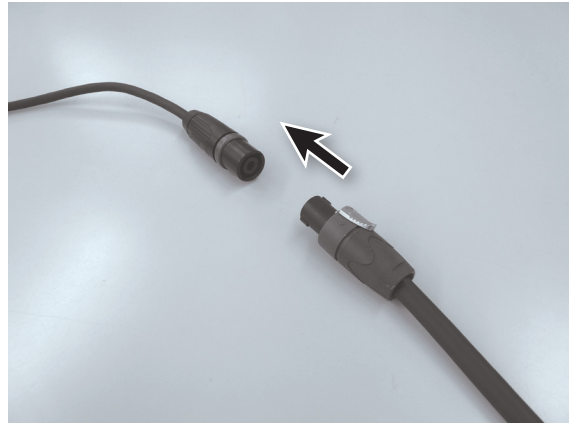

2. Tourner la fiche DC OUTPUT du S-240P dans le sens des aiguilles d'une montre jusqu'à ce que vous entendiez un déclic.

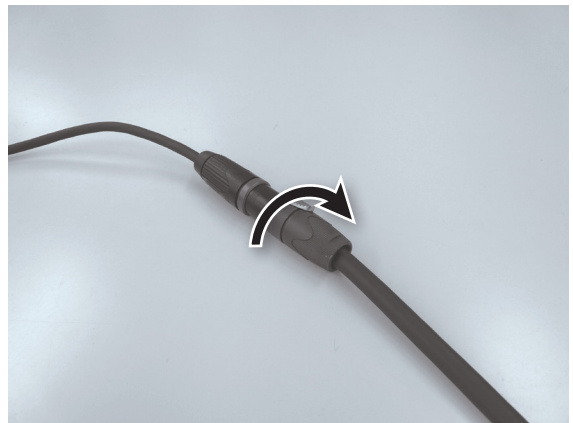

3. Insérer le câble de l'adaptateur (extrémité XLR4) dans le connecteur EXT. POWER DC INPUT du M-5000 jusqu'à ce que vous entendiez un déclic.

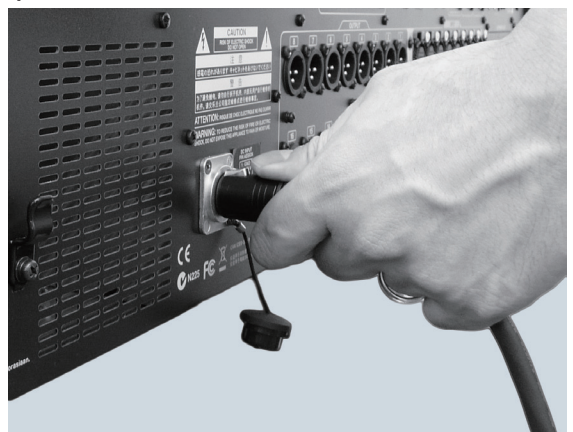

Disconnecting Backup Power

Follow the steps below to disconnect the external power unit.

1. While keeping the lock switch on the adapter cable (XLR4 end) connected to the S-240P depressed, detach the cable from the EXT. POWER DC INPUT connector.

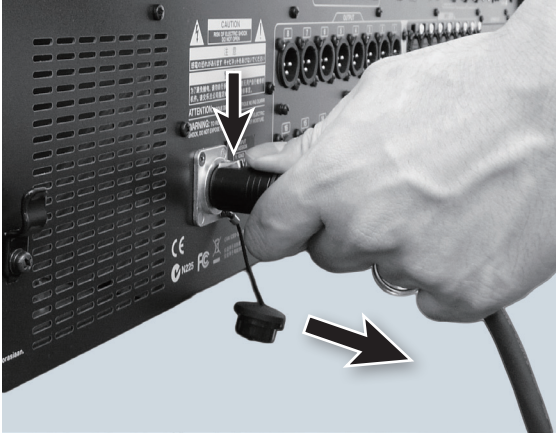

2. While holding the lock switch on the S-240P's DC OUTPUT plug pulled back, twist counterclockwise.

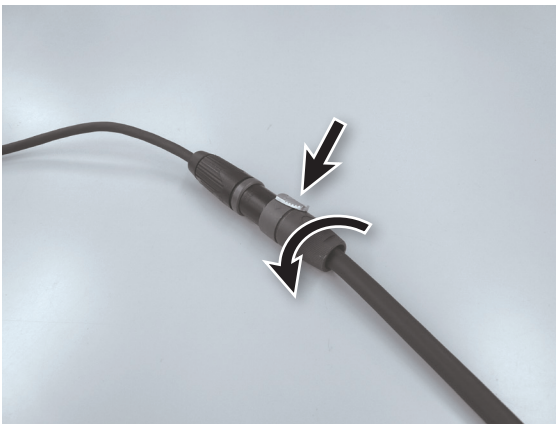

3. Detach the DC OUTPUT plug on the S-240P from the adapter cable (Speakon end).

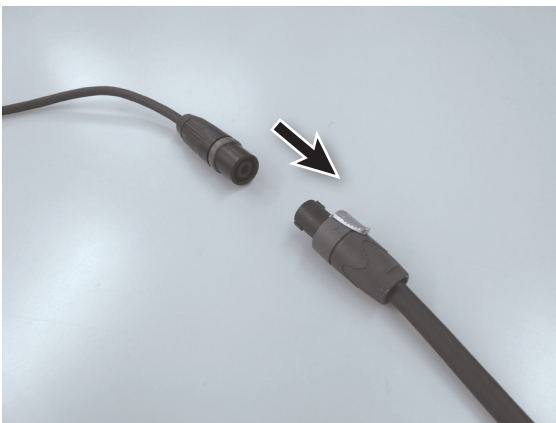

Turning the Power On and Off

- * To prevent malfunction and equipment failure, always turn down the volume, and turn off all the units before making any connections.
- * Before turning the unit on/off, always be sure to turn the volume down. Even with the volume turned down, you might hear some sound when switching the unit on/off. However, this is normal and does not indicate a malfunction.

Turning the Power On

- * Once everything is properly connecte be sure to follow the procedure below to turn on their power. If you turn on equipment in the wrong order, you risk causing malfunction or equipment failure.

1. Turn on the power to any equipment connected to audio inputs on the M-5000 or on any input/output units (S-2416, S-4000S, or the like) connected to the M-5000.
2. Turn on the [POWER] switch on the M-5000.
 - * This unit is equipped with a protection circuit. A brief interval (a few seconds) after turning the unit on is required before it will operate normally.
 - * When restarting the unit with the expansion interface installed, wait for about one second before you turn on the power.
3. Turn on the power to the external power unit connected to the EXT. POWER DC INPUT connector on the M-5000.
4. Turn on the power to the input/output units.
5. Turn on the power to any equipment connected to audio output on the M-5000 or on any input/output units.

Turning the Power Off

1. Go to the MUTE GROUP MASTER window and tap <MUTE ALL OUTPUTS> to mute audio output on the M-5000 and on any input/output units (S-2416, S-4000, or the like) connected to the M-5000.
 - "Muting All Outputs" (p. 62)
2. Turn down the output and turn off the power to any equipment connected to audio output on the M-5000 or on any input/output units.
3. Turn off the power to the external power unit connected to the EXT. POWER DC INPUT connector on the M-5000.
 - * If an external power Unit is providing power to the M-5000, the M-5000 will keep operating even if the power switch is in the OFF position.
4. Turn off the [POWER] switch on the M-5000.
5. Turn off the power to the input/output units.
6. Turn off the power to any equipment connected to audio input on the M-5000 or on any input/output units.
 - * When restarting the unit with the expansion interface installed, wait for about one second before you turn on the power.
 - * If you need to turn off the power completely, first turn off the unit, then unplug the power cord from the power outlet. Refer to "To completely turn off power to the unit, pull out the plug from the outlet" (p. 4).

Déconnexion de l'alimentation de secours

Suivre les étapes ci-dessous pour débrancher l'unité d'alimentation externe.

1. Tout en maintenant le commutateur de verrouillage du câble de l'adaptateur (extrémité XLR4) relié au S-240P non pressé, débrancher le câble du connecteur EXT. POWER DC INPUT.

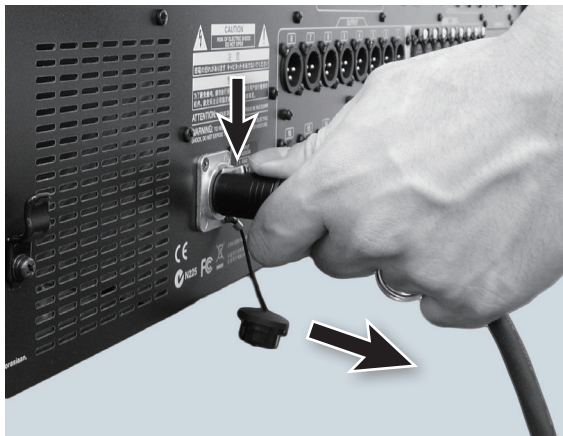

2. Tout en maintenant le commutateur de verrouillage sur la fiche DC OUTPUT du S-240P tiré vers l'arrière, tournez dans le sens inverse des aiguilles d'une montre.

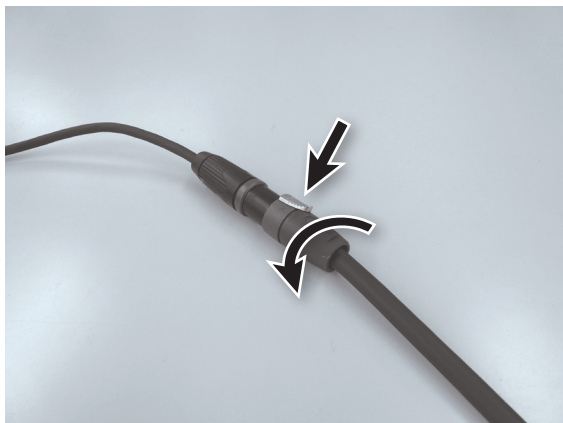

3. Détacher la fiche DC OUTPUT sur le S-240P du câble de l'adaptateur (extrémité Speakon).

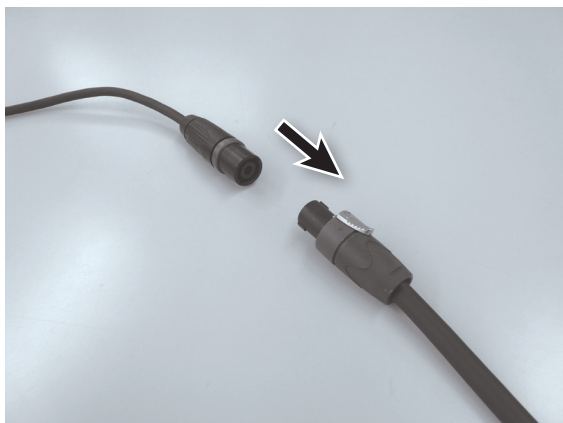

Mise sous tension et hors tension de l'appareil

- * Pour éviter tout dysfonctionnement ou panne de l'équipement, toujours baisser le volume et éteindre toutes les unités avant de faire des connexions.
- * Avant d'allumer/éteindre l'appareil, veuillez toujours baisser le volume. Même avec le volume au minimum, un son peut se faire entendre lorsque vous allumez/éteignez l'appareil. Cependant, c'est tout à fait normal et n'indique pas un dysfonctionnement.

Mise sous tension

- * Une fois que tout est correctement connecté veuillez à bien suivre la procédure ci-dessous pour la mise sous tension de l'appareil. Si vous allumez l'équipement dans le mauvais ordre, vous risquez de provoquer un dysfonctionnement ou une panne de l'équipement.

1. Allumer tout appareil raccordé aux entrées audio du M-5000 ou de toute unité d'entrée/sortie (S-2416, S-4000S, ou autres) connectée au M-5000.
2. Allumer l'interrupteur [POWER] du M-5000.
 - * Cet appareil est équipé d'un circuit de protection. Un bref laps de temps (quelques secondes) après allumage de l'appareil est nécessaire avant qu'il puisse fonctionner normalement.
 - * Lors du redémarrage de l'unité avec l'interface d'extension installée, attendre pendant environ une seconde avant la mise sous tension.
3. Allumer l'unité d'alimentation externe branchée sur le connecteur EXT. POWER DC INPUT du M-5000.
4. Allumer les unités d'entrée/sortie.
5. Allumer tout équipement connecté à la sortie audio du M-5000 ou toute unité d'entrée/sortie.

Mise hors tension

1. Aller à la fenêtre MUTE GROUP (GROUPE EN SOURDINE) puis appuyez sur <MUTE ALL OUTPUTS> (TOUTES SORTIES EN SOURDINE) pour couper la sortie audio du M-5000 et de toute unité d'entrée/sortie (S-2416, S-4000, ou autres) connectée au M-5000.
 - "Muting All Outputs" (p. 62)
2. Baisser la sortie et éteindre l'alimentation de tout appareil raccordé à la sortie audio du M-5000 ou de toute unité d'entrée/sortie.
3. Éteindre l'unité d'alimentation externe branchée sur le connecteur EXT. POWER DC INPUT du M-5000.
 - * Si une unité d'alimentation externe alimente le M-5000, le M-5000 va continuer à fonctionner même si l'interrupteur d'alimentation est en position OFF.

Replacing the Internal Lithium Battery

The M-5000 has an internal lithium battery that maintains the unit's clock function and preserves the mixer settings. If the battery runs down, the clock function and recovery of mixer settings before power-down can fail to operate correctly. If a popup message prompting battery replacement appears after turning on the power, follow the procedure below to replace the battery.

The type of the replacement lithium battery is CR2032. When purchasing a replacement, specify a "CR2032 lithium battery" at an electrical-appliance store or other such point of sale.

- * Use only the specified type (model no. CR2032) of lithium batteries. Be sure to insert it as directed (to ensure correct polarity).
- * Used lithium batteries must be disposed of in compliance with whatever regulations for their safe disposal that may be observed in the region in which you live.

1. Save the data in the M-5000.

→ "Backing Up All Data in the M-5000" (p. 61)

2. Turn off the power to the M-5000 and unplug the power cord from the power outlet.

3. Loosen the mounting screw for the BATTERY slot and detach the BATTERY panel.



4. Take out the old battery and replace it with a fresh one.

Press down on the battery to eject it. Install so that the battery's "+" (plus) symbol faces back toward the front.

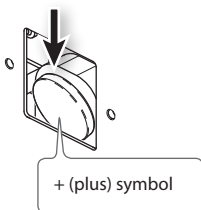

NOTE

Be careful to avoid cutting your hand on the opening.

5. Attach the BATTERY panel and secure it in place using the screw loosened in step 3.

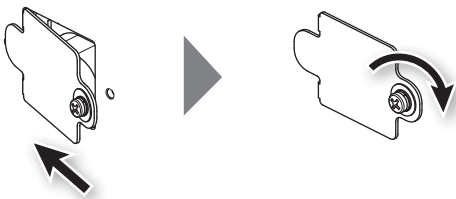

6. Turn on the power to the M-5000 and set the date and time.

→ "Setting the Date and Time" (p. 63)

7. Restoring All Data in the M-5000

→ "Restoring All Data in the M-5000" (p. 62)

Attaching the Tablet Sheets

Attach the tablet sheets at the places shown below. They will protect your tablet / smartphone / PC.

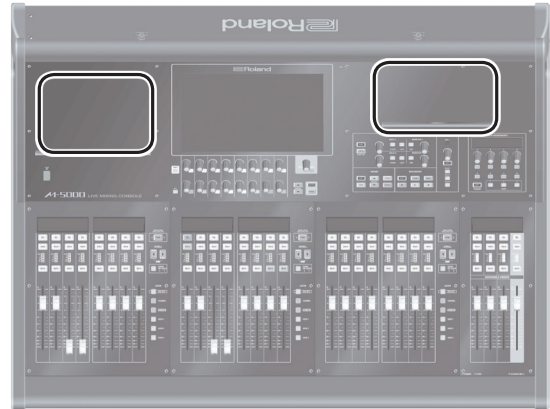

M-5000

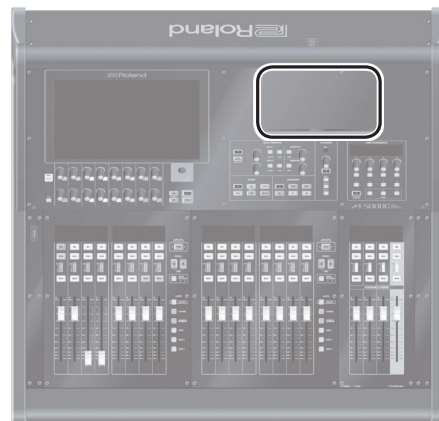

M-5000C

4. Commuter l'interrupteur [POWER] du M-5000 en position OFF.

5. Éteindre les unités d'entrée/sortie.

6. Éteindre tout équipement connecté à l'entrée audio du M-5000 ou toute unité d'entrée/sortie

- * Lors du redémarrage de l'unité avec l'interface d'extension installée, attendre pendant environ une seconde avant la mise sous tension.
- * Si vous devez éteindre complètement l'alimentation, éteignez d'abord l'appareil avant de débrancher le cordon d'alimentation de la prise de courant. Consultez **"Pour éteindre complètement l'alimentation de l'appareil, retirer la fiche de la prise" (p. 6)**.

5. Attacher le panneau de la PILE avant de le fixer à l'aide de la vis desserrée à l'étape 3.

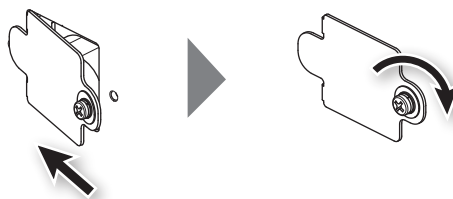

6. Allumer le M-5000 et régler la date et l'heure.

→ "Setting the Date and Time" (p. 63)

7. Restaurer toutes les données dans le M-5000

→ "Restoring All Data in the M-5000" (p. 62)

Remplacement de la pile au lithium interne

Le M-5000 est équipé d'une pile interne au lithium qui maintient la fonction d'horloge de l'unité et conserve les réglages de la console. Si la pile est déchargée, la fonction d'horloge et de récupération des réglages de la console avant la mise hors tension risque de ne pas fonctionner correctement. Si un message contextuel demandant le remplacement de la pile apparaît après la mise sous tension, veuillez suivre la procédure ci-dessous pour remplacer la pile.

Le modèle de pile au lithium de rechange est CR2032. Lors de l'achat d'une nouvelle pile, veuillez spécifier une "pile au lithium CR2032" dans un magasin d'appareils électriques ou tout autre point de vente similaire.

- * N'utilisez que le type de piles au lithium spécifié (modèle n°CR2032). Assurez-vous de les insérer en respectant les instructions (pour que la polarité soit correcte).
- * Les piles au lithium usagées doivent être mises au rebut conformément à la réglementation en vigueur dans la région où vous résidez.

1. Sauvegarder les données dans le M-5000.

→ "Backing Up All Data in the M-5000" (p. 61)

2. Éteindre l'alimentation du M-5000 et débrancher le cordon d'alimentation de la prise de courant.

3. Desserrer la vis de fixation du logement de la PILE puis détacher le panneau de la PILE.



4. Ôter la vieille pile et la remplacer par une neuve.

Appuyer sur la pile vers le bas pour l'éjecter.

L'installer afin que le symbole "+" (plus) de la pile soit tourné vers l'avant.

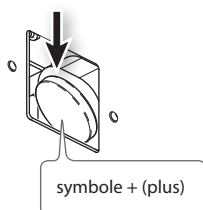

NOTE

Faites attention à ne pas vous couper la main avec l'ouverture.

Fixation des housses de tablette

Fixez les housses de tablette aux endroits indiqués ci-dessous. Ils protégeront votre tablette / smartphone / PC.

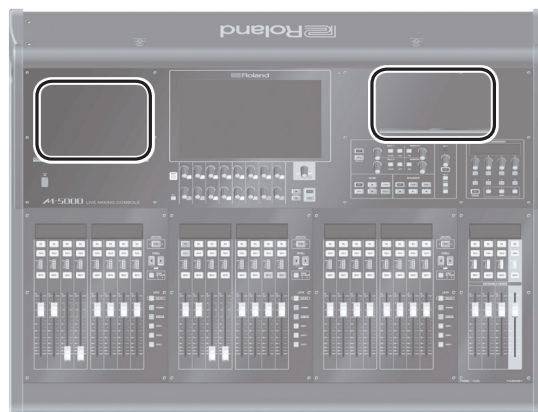

M-5000

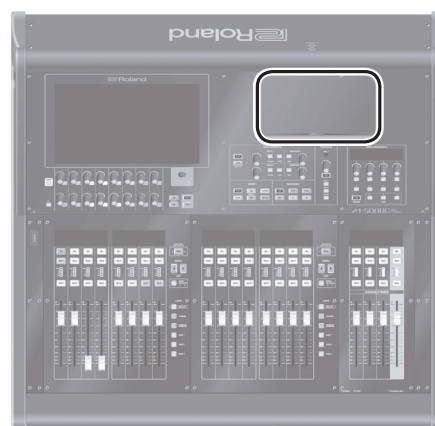

M-5000C

Installing an Expansion Interface (Option)

You can expand the M-5000's input and output capabilities by installing a separately available expansion interface into the unit's expansion slot.

For information on the expansion interfaces that can be installed in the M-5000, refer to the Roland website.

* When restarting the unit with the expansion interface installed, wait for about one second before you turn on the power.

1. Turn off the power to the M-5000 and unplug the power cord from the power outlet.
2. Loosen the mounting screws (2) for the expansion slot specified in the figure, then detach the panel.

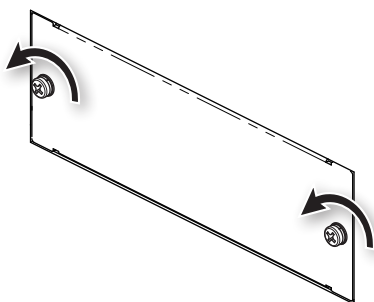

3. Insert the expansion interface.

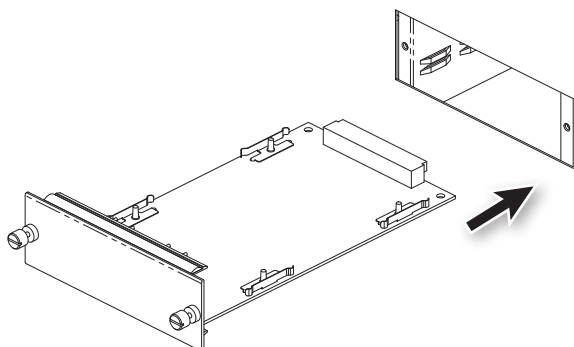

- * To avoid the risk of damage to internal components that can be caused by static electricity, please carefully observe the following whenever you handle the expansion interface.
- Before you touch the expansion interface, always first grasp a metal object (such as a water pipe), so you are sure that any static electricity you might have been carrying has been discharged.
- When handling the expansion interface, grasp it only by the panel or the expansion interface's edges. Avoid touching any of the electronic components or connectors.
- Save the bag in which the expansion interface was originally shipped, and put the expansion interface back into it whenever you need to store or transport it.

4. Secure using the screws (2) for the expansion slot specified in the figure.

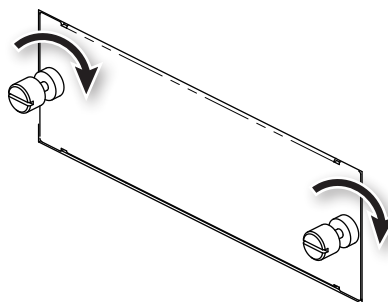

- * Install only the specified expansion interface. Remove only the specified screws.
- * Before installing the expansion interface, you must first always turn off the unit and unplug its power cord.
- * Do not touch any of the printed circuit pathways or connection terminals.
- * Never use excessive force when installing an expansion interface. If it doesn't fit properly on the first attempt, remove the expansion interface and try again.
- * When expansion interface installation is complete, double-check your work.
- * Always turn the unit off and unplug the power cord before attempting installation of the expansion interface.

Using the LAN-cable Hook

Engage the LAN cable connected to the LAN port on the LAN-cable hook as shown in the figure to secure it in place. This can help prevent inadvertent detachment of the LAN cable.

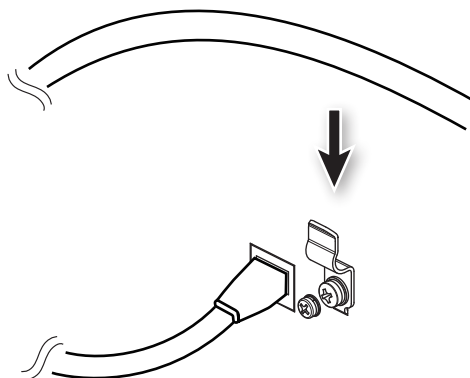

- * Never apply strong force to the LAN cable.
- * Never wind (bend) the LAN cable using a coil radius of 25 millimeters or less, or bend the cable sharply enough to kink it.

Installation d'une interface d'extension (en option)

Vous pouvez étendre les capacités d'entrée et de sortie du M-5000 en installant dans le logement d'extension de l'unité une interface d'extension vendue séparément.

Pour plus d'informations sur les interfaces d'extension qui peuvent être installées dans le M-5000, veuillez consulter le site Web Roland suivant.

- * Lors du redémarrage de l'unité avec l'interface d'extension installée, attendre pendant environ une seconde avant la mise sous tension.

1. Éteindre l'alimentation du M-5000 et débrancher le cordon d'alimentation de la prise de courant.
2. Desserrer les vis de fixation (2) du logement d'extension indiqué sur la figure, puis retirer le panneau.

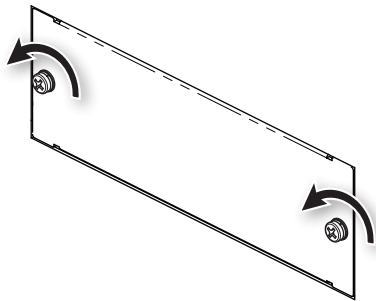

3. Insérez l'interface d'extension.

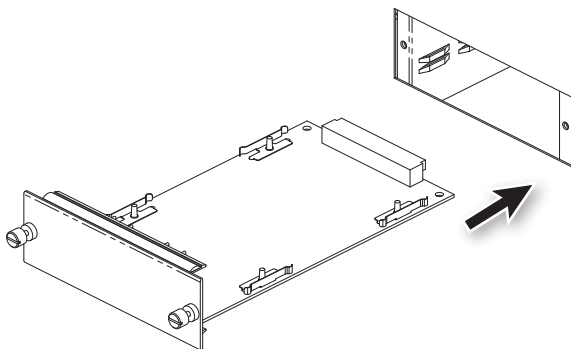

- * Pour éviter tout risque d'endommager les composants internes à cause de l'électricité statique, veuillez respecter attentivement les instructions suivantes lorsque vous manipulez l'interface d'extension.
- Avant de toucher l'interface d'extension, toujours serrer préalablement un objet métallique (comme un tuyau d'eau), afin de s'assurer que l'électricité statique dont vous pourriez être porteur a été déchargée.
- Lorsque vous manipulez l'interface d'extension, veuillez ne la tenir que par le panneau ou les bords de l'interface d'extension. Évitez de toucher les composants électroniques ou les connecteurs.
- Conservez l'emballage dans lequel l'interface d'extension a été expédiée pour y mettre l'interface d'extension lorsque vous avez besoin de la stocker ou de la transporter.

4. Fixer à l'aide des vis (2) pour l'emplacement d'extension indiqué sur l'illustration.

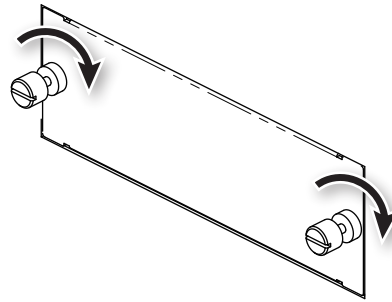

- * Installez uniquement l'interface d'extension indiquée. Retirez uniquement les vis indiquées.
- * Avant d'installer l'interface d'extension, vous devez d'abord toujours éteindre l'appareil et débrancher son cordon d'alimentation.
- * Ne pas toucher aux circuits imprimés ou aux bornes de connexion.
- * Ne jamais forcer lors de l'installation d'une interface d'extension. Si elle ne s'insère pas correctement lors de la première tentative, retirez l'interface d'extension et essayez à nouveau.
- * Lorsque l'installation de l'interface d'extension est terminée, vérifiez votre travail.
- * Toujours éteindre l'appareil et débrancher son cordon d'alimentation avant de procéder à l'installation d'une interface d'extension.

Utilisation du crochet de câble réseau

Engager le câble réseau branché au port LAN sur le crochet de câble réseau comme indiqué sur la figure pour le fixer en place. Cela peut aider à prévenir le détachement accidentel du câble réseau.

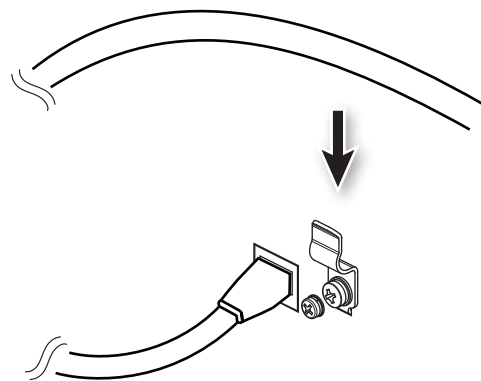

- * Ne jamais forcer sur le câble réseau.
- * Ne jamais enrouler (plier) le câble réseau avec un rayon de bobine de 25 mm ou moins, ou plier le câble au point de l'emmêler.

Installing REAC Devices

Basic REAC Knowledge

REAC (Roland Ethernet Audio Communication) is Roland's own original digital audio-transmission technology using Ethernet. Its uses protocol independently developed by Roland based on Ethernet technology, and makes possible transmission of 40 input and 40 output channels of 24-bit digital audio at 96 kHz using a single Category 5e Ethernet cable. REAC devices can also easily be interconnected.

- Capable of 40 input and 40 output of 24-bit digital audio at 96 kHz
- Allows easy device connection using just master, slave, and split settings
- Capable of transmission of up to 100 meters over a single Cat 5e cable
- Extension of cable length possible using an Ethernet switching hub
- Easy signal splitting possible using a switching hub
- Extremely short transmission latency between REAC devices (approx. 375 microseconds)

About Cables

Because Category 5e Ethernet cables are used, connecting REAC devices to one another is simple and easy. These Cat 5e Ethernet cables are ordinarily used to make computer network connections.

Ethernet Cable Types

- Crossover cable
The cable's internal wiring crosses over at each RJ45 plug. This means that the connections of the RJ45 plugs at either end of the signal cable are different.
- Straight cable
The cable's internal wiring is arranged identically at each end.

With this unit, you can use either crossover cables or straight cables. For making connections to the REAC ports, we recommend using optionally available REAC cables (SC-W20F, SC-W100S, W100S-R, etc.).

Ethernet Connectors

Ethernet cables use RJ45 plugs. REAC devices are provided with an RJ45 connector at REAC port.

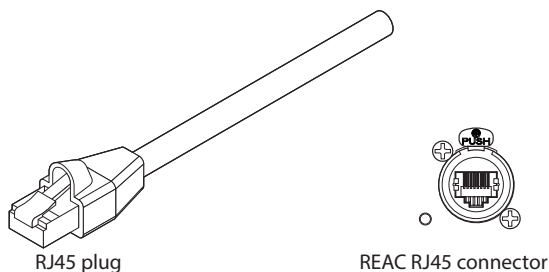

For critically important communication, protecting RJ45 plugs and connectors is vital. In such cases, rugged Neutrik EtherCon plugs are used for the REAC RJ45 plugs.

Using EtherCon RJ45 plugs makes possible the same kind of latch-locked connections as when using XLR plugs.

Neutrik provides EtherCon RJ45 plugs, as well as EtherCon plugs that you can add to or use to modify RJ45 plugs on third-party Ethernet cables.

Important Notes on Handling Ethernet Cables

- Never apply strong force to Ethernet cables.
- Never wind (bend) an Ethernet cable using a coil radius of 25 millimeters or less, or bend the cable sharply enough to kink it.
- Never bind bundled Ethernet cables too tightly.
- Never run lengths of multiple Ethernet cables in parallel over long distances.
- Keep Ethernet cables away from sources of noise (such as power cords, motors, and fluorescent lights).

Connecting REAC Input/Output Units

This describes how to connect REAC input/output units to the M-5000.

This section shows a typical example of a connection using the S-2416. For connections of greater complexity, refer to the Reference Manual (PDF).

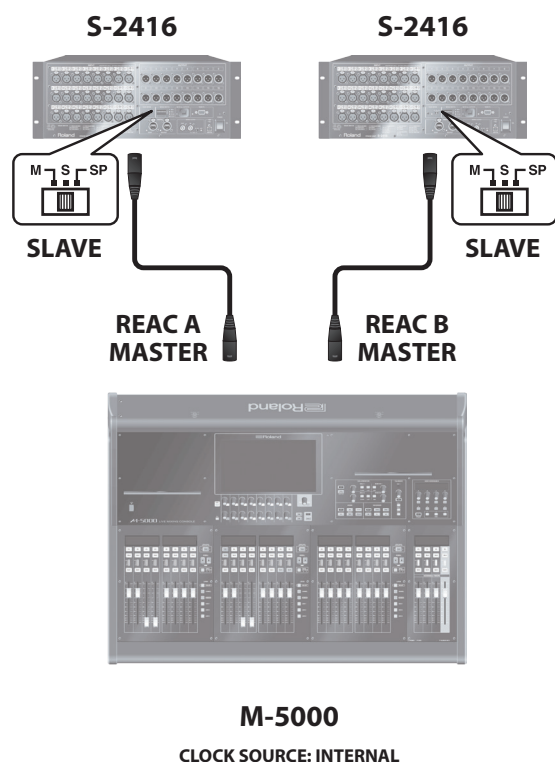

The input/output units connected to the REAC A and B ports and the default input/output patchbays on the M-5000 are as follows.

Input port	Input channel
REAC A INPUT 1–24	CH 1–24
REAC B INPUT 1–24	CH 25–48
CONSOLE INPUT 1–16	CH 49–64
FX 7 OUTPUT L/R	CH 65 (stereo)
FX 8 OUTPUT L/R	CH 66 (stereo)
DOCK L/R	CH 67 (stereo)
PLAY L/R	CH 68 (stereo)

Output port	Output bus
REAC A OUTPUT 1–16	AUX 1–16
REAC B OUTPUT 1–8	AUX 17–24
REAC B OUTPUT 9–13	MATRIX 1–5
REAC B OUTPUT 14–16	MAIN L, R, C
CONSOLE OUTPUT 15–16 (M-5000 only)	MONITOR 1 L,R

Important Notes on REAC Connections

REAC connections are designed not to produce noise when hot-swapping (inserting or detaching live lines) is performed. In rare cases, however, noise might occur in the system's audio output. The following two methods can prevent damage due to hot-swapping to speakers or other devices connected to audio outputs.

- Make the REAC connection while holding down [MUTE ALL OUTPUTS] on the input/output unit.
- Go to the MUTE GROUP MASTER window and use [MUTE ALL OUTPUTS] to mute output, then make the REAC connection.

→ "Muting All Outputs" (p. 62)

Part Names and Functions

Top Panel

M-5000

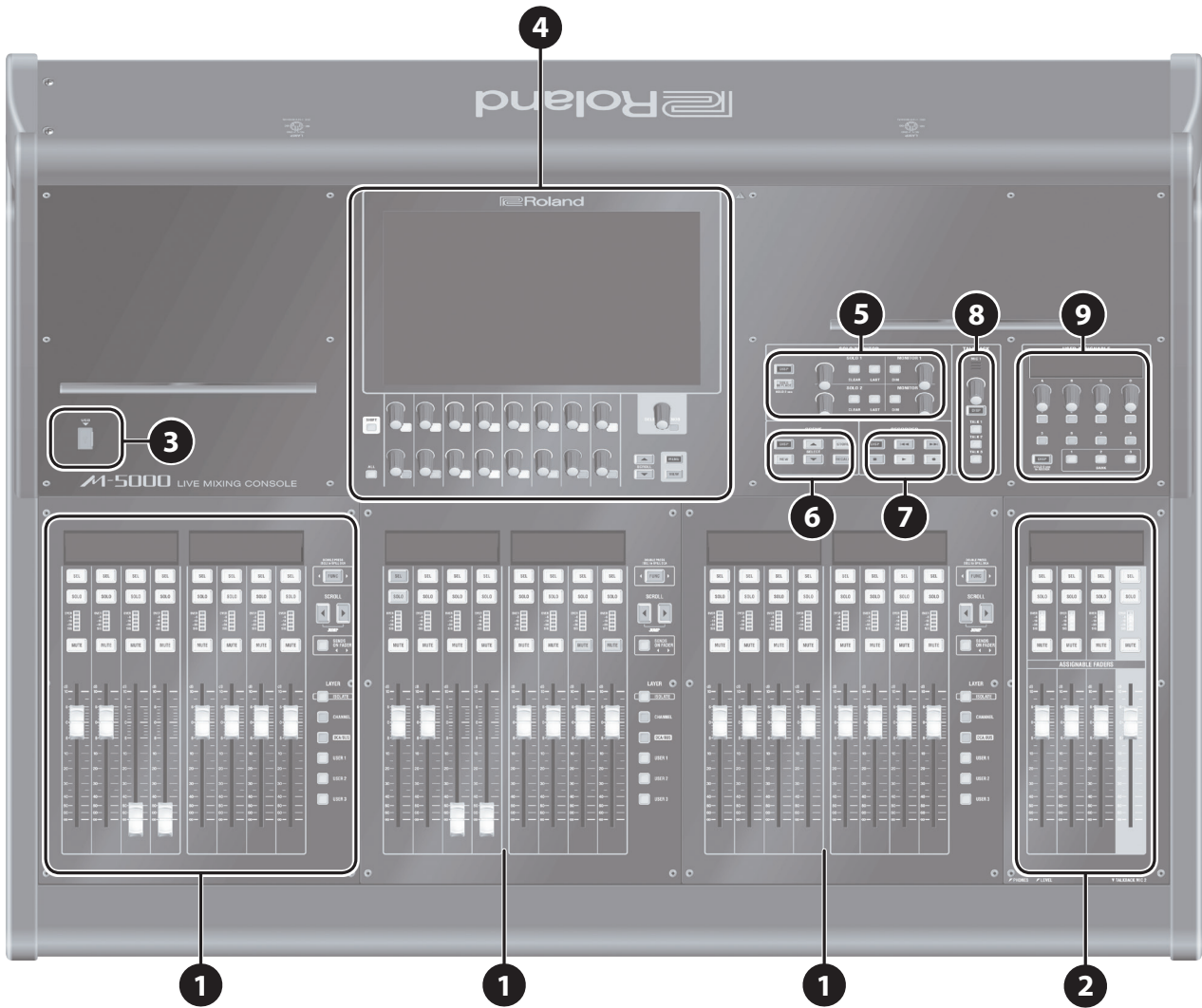

M-5000C

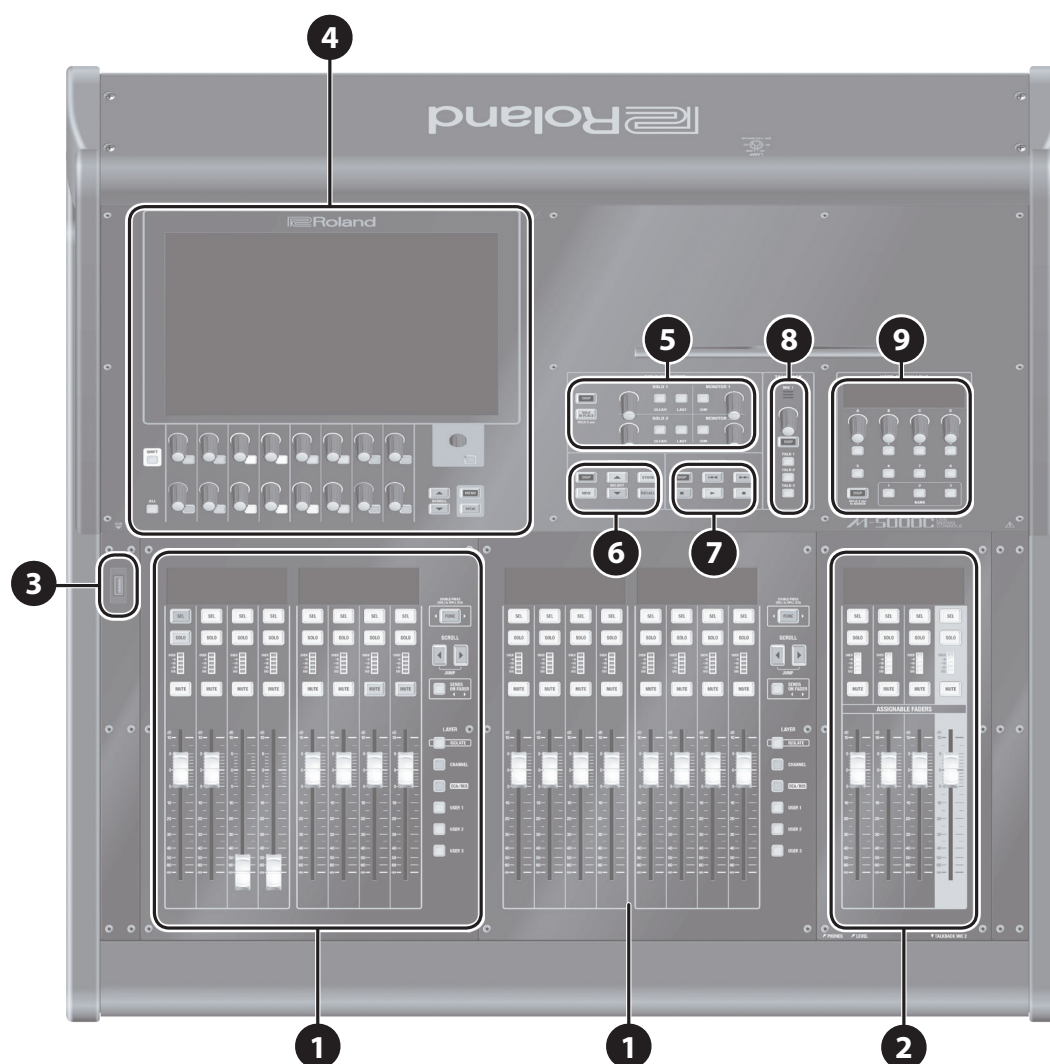

1 Fader Bank Section

This section is for working with input channels and output buses in sets of eight. You use the layer buttons and scroll buttons to access the desired input channel or output bus.

→ “Fader Bank Section” (p. 30)

2 Assignable Fader Section

This section lets you assign any four input channels or output buses select. This makes it possible to keep important input channels and output buses accessible on the top panel at all times.

→ “Assignable Fader Section” (p. 31)

3 USB MEMORY Connector

This connector is for connecting a USB flash drive.

→ “USB MEMORY Connector” (p. 31)

4 Display Section

This section is for displaying and working with mixer parameters and system settings.

→ “Display Section” (p. 32)

5 Monitor Section

This section is for working with and controlling the monitor buses.

→ “Monitor Section” (p. 33)

6 Scene Section

This section is for working with scene memories.

→ “Scene Section” (p. 34)

7 Recorder Section

This section is for working with and controlling a USB memory recorder or another external recorder such as the R-1000 48-track recorder.

→ “Recorder Section” (p. 34)

8 Talkback Section

This section is for working with and controlling talkback functions.

→ “Talkback Section” (p. 35)

9 User-assignable Section

This section is for assigning and working with parameters of your choosing.

→ “User-assignable Section” (p. 36)

Fader Bank Section

This section is for working with eight input channels or output buses or both. You use layer selection and scrolling to access the desired input channel or output bus.

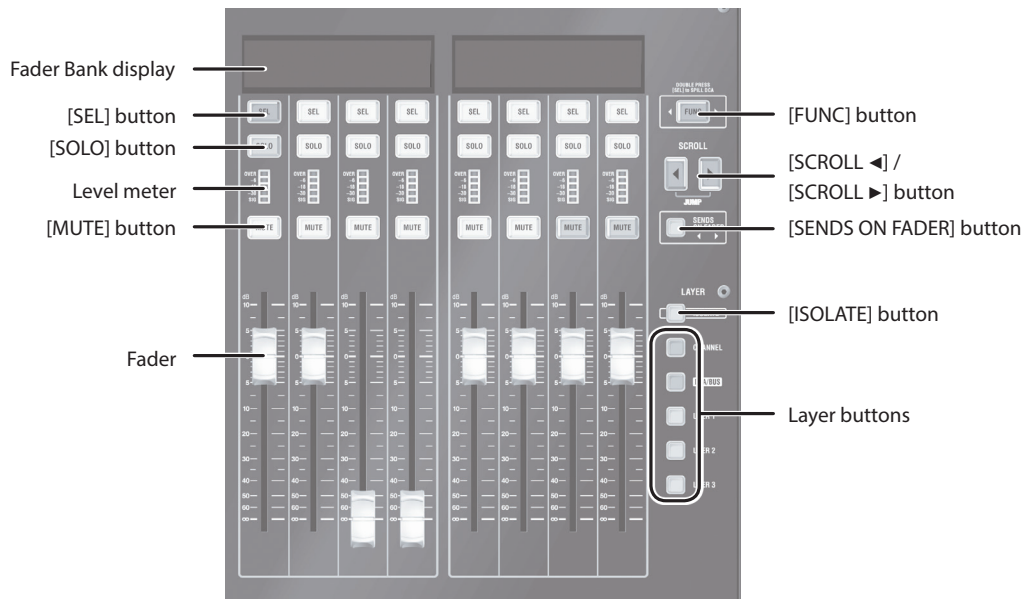

Name	Description
Fader bank display	This displays information such as the input channel/output bus name and fader value. In the Function mode, it displays menu information such as a list of functions and parameter values.
[SEL] button	This selects the input channel/output bus designating the display target. In the Function mode, it selects the function and sets parameters.
[SOLO] button	This turns solo on and off for the input channel/output bus.
Level meter	This displays the signal level of the input channel/output bus.
[MUTE] button	This turns muting on and off for the input channel/output bus.
Fader	This operates the fader for the input channel/output bus.
[FUNC] button	This turns the function mode on and off. It flashes when the function mode is on.
[SCROLL ◀] / [SCROLL ▶] button (JUMP)	This scrolls the channel left and right. Pressing [SCROLL ◀] and [SCROLL ▶] at the same time displays the anchor channel where the currently selected Layer in the fader bank display is registered (anchor jump).
[SENDS ON FADER] button	This turns SENDS ON FADER on and off. It flashes when on. → "Using Faders to Adjust the Send Level to AUX (SENDS ON FADER)" (p. 53)
[ISOLATE] button	This turns the isolation of Fader Bank on and off. → "Isolated Banks" (p. 48)
Layer buttons	This selects the layer for the Fader Bank section. The button for the selected layer lights up.

Assignable Fader Section

This section lets you assign any four channels of your choosing to the 4 assignable faders. This makes it possible to keep important channels accessible at all times.

For details, refer to the "Assignable Fader Section" in the Reference Manual (PDF).

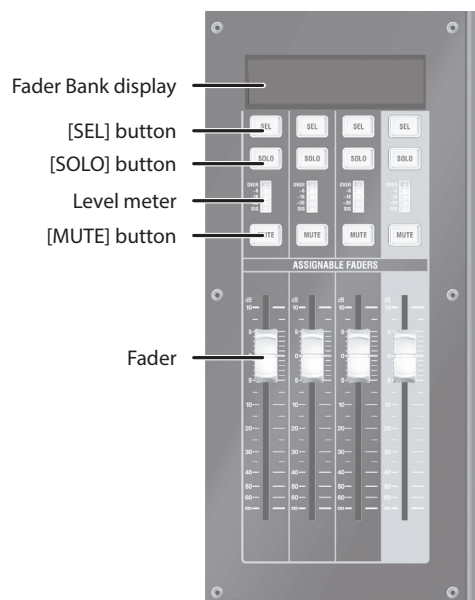

Name	Description
Fader Bank display	This displays information such as the input channel/output bus name and fader value. In the Function mode, it displays information such as a list of functions and parameter values.
[SEL] button	This selects the input channel/output bus and selects the display target. In the function mode, it selects the function and manipulates parameters.
[SOLO] button	This turns solo on and off for the input channel/output bus.
Level meter	This displays the signal level of the input channel/output bus.
[MUTE] button	This turns muting on and off for the input channel/output bus.
Fader	This operates the fader for the input channel/output bus.

USB MEMORY Connector

The M-5000 can use a USB flash drive to store and load a variety of data.

- Project files
 - "Saving a Project File to a USB Flash Drive" (p. 61)
 - "Loading a Project File from a USB Flash Drive" (p. 62)
- Recording and playback of WAV files using a USB flash drive
 - "Recording/Playback to/from a USB Flash Drive" (p. 60)

NOTE

- * Never turn off the power or disconnect the USB flash drives when the access lamp of USB flash drives are lit or blinking
- * Carefully insert the USB flash drive all the way in—until it is firmly in place.

MEMO

- Before using a USB flash drive on this unit, please format the USB flash drives using the built-in format function..
 - "Formatting a USB Flash Drive on the M-5000" (p. 62)
- Some USB flash drives might not be able to be used on this unit. If an error message appears when formatting as described in "Formatting a USB Flash Drive on the M-5000" (p. 62), it is not possible to use for this USB flash drive on the M-5000.
- The M-5000 supports only USB flash drives (USB flash Memory and USB memory). USB Hard Disk and Memory Card Readers are not supported.
- USB flash drives do not work via USB hub.

Display Section

This section lets you display and work with mixer parameters, system settings, and other values. For details, refer to the "Operation of the touch display" section in the Reference Manual (PDF).

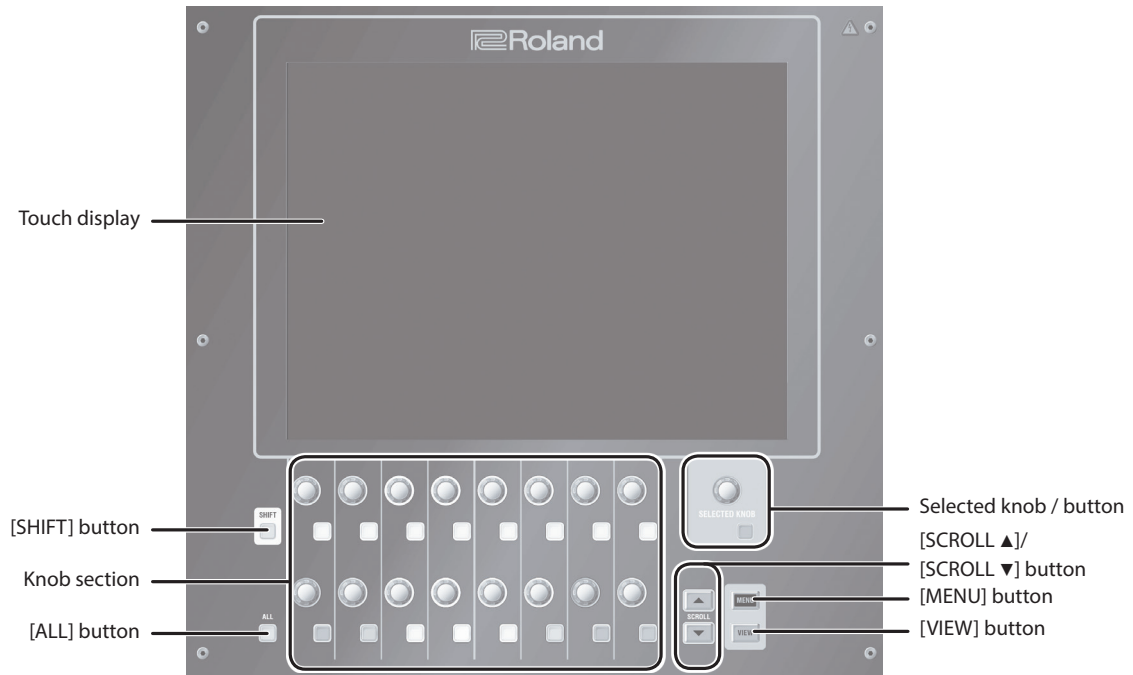

Name	Description
Touch display	This displays mixer parameters, settings, and other values. You touch this to manipulate the parameters.
[SHIFT] button	This changes the functioning of buttons while depressed.
Knob section	This manipulates the parameter area displayed at the bottom of the touch display. The color or the knob or button changes according to the parameter.
[ALL] button	When this is pressed, the action of the knob or button is applied to the eight channels shown on the touch display.
Selected knob / button	This manipulates the selected parameter on the touch display. The color of the knob or button changes according to the selected parameter.
[SCROLL ▲]/[SCROLL ▼] button	This switches the AUX value selected at the knob-assign area of the HOME screen (p. 50).
[MENU] button	This makes the MENU window appear on the touch display.
[VIEW] button	This switches the appearance of the channel strip on the HOME screen (p. 50).

- * Pressing or scraping the surface of the touch display using a pointed object can damage the touch display.
- * If the touch display surface becomes dirty, clean by wiping gently using a soft cloth moistened with neutral detergent.

Monitor Section

This section is for working with monitor functions.

This unit is provided with two monitor systems.

The available selections for MONITOR 1 are 5.1, STEREO, and NONE (no assignment), and the available selections for MONITOR 2 are STEREO and NONE (no assignment).

The unit is also provided with two solo systems. These are SOLO 1 for MONITOR 1 and SOLO 2 for MONITOR 2.

The input channel or output bus selected using [SOLO] on the top panel is sent to the monitor.

For details, refer to the "Monitor" section in the Reference Manual (PDF).

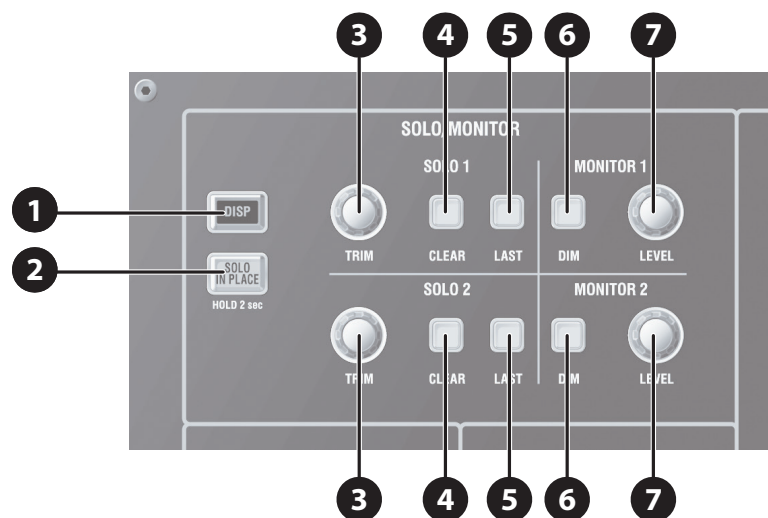

Number	Name	Description
1	[DISP] button	This displays the MONITOR window.
2	[SOLO IN PLACE] button	This turns Solo in Place on and off. To turn on Solo in Place, press and hold this button for 2 seconds. It flashes when on. * When Solo in Place is on, a solo signal is sent to the output buses. Note that input channels where solo is turned off are not output.
3	SOLO 1 / SOLO 2 [TRIM] knob	This adjusts the level of SOLO 1 or 2.
4	SOLO 1 / SOLO 2 [CLEAR] button	This clears SOLO 1 or 2. It flashes when a channel is currently soloed.
5	SOLO 1 / SOLO 2 [LAST] button	This turns the LAST mode on and off for SOLO 1 or 2.
6	MONITOR 1 / MONITOR 2 [DIM] button	This turns the dimmer on and off for MONITOR 1 or 2.
7	MONITOR 1 / MONITOR 2 [LEVEL] button	This adjusts the level of MONITOR 1 or 2.

Scene Section

This section is for working with scene memories.

Scene memory is a function that lets you store and recall mixing parameters as “scenes.”

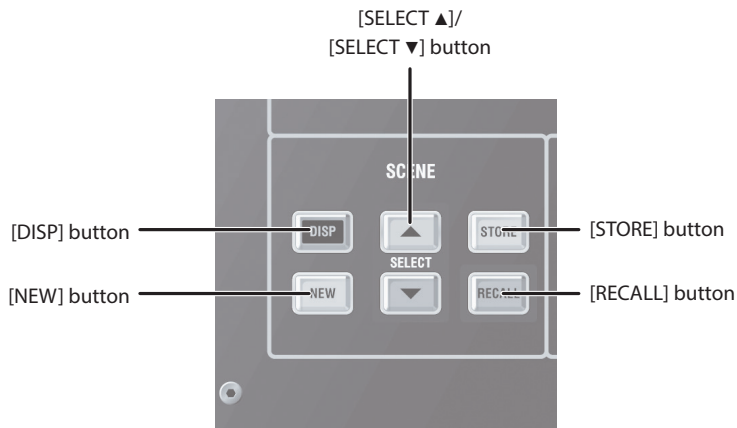

Name	Description
[DISP] button	This displays the SCENE window.
[NEW] button	This creates a new scene after the selected scene, and saves the current mixer parameters.
[SELECT ▲] button	This selects the scene just before the currently selected scene.
[SELECT ▼] button	This selects the scene just after the currently selected scene.
[STORE] button	This stores the current mixer parameters to the selected scene.
[RECALL] button	This recalls the mixer parameters from the selected scene.

Recorder Section

This section is for working with a USB memory recorder or another external recorder such as the R-1000 48-track recorder.

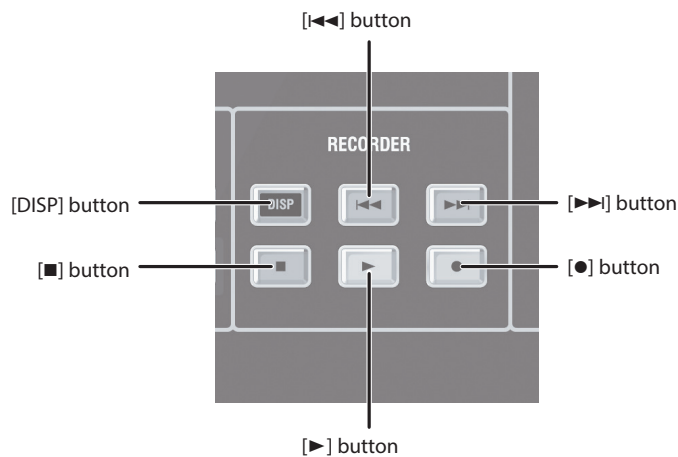

Name	Description
[DISP] button	This displays the RECORDER window.
[■] button	This stops recording/playback.
[◀] button	This selects the previous song. Holding this down during playback rewinds the song being played.
[▶] button	This selects the next song. Holding this down during playback fast-forwards the song being played.
[▶] button	This starts recording/playback.
[●] button	This puts the unit into recording standby.

Talkback Section

This section is for working with talkback functions.

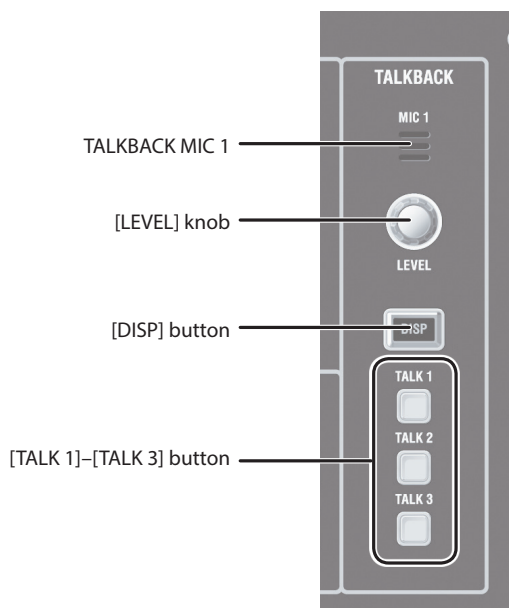

Name	Description
TALKBACK MIC 1	This is the internal microphone for talkback.
[LEVEL] knob	This adjusts the level of talkback.
[DISP] button	This displays the TALKBACK/OSC window.
[TALK 1]–[TALK 3] button	These send talkback to the output destinations assigned to TALK 1 through TALK 3.

MEMO

The way in which talkback is turned on and off differs depending on how you press the [TALK 1] through [TALK 3] buttons.

When you release the button quickly after pressing it, it operates as a toggle turning talkback on or off with each press.

When depressed for a longer interval before releasing, it operates as a momentary switch that turns on talkback only while held down.

User-assignable Section

This section is for assigning and working with parameters of your choosing.

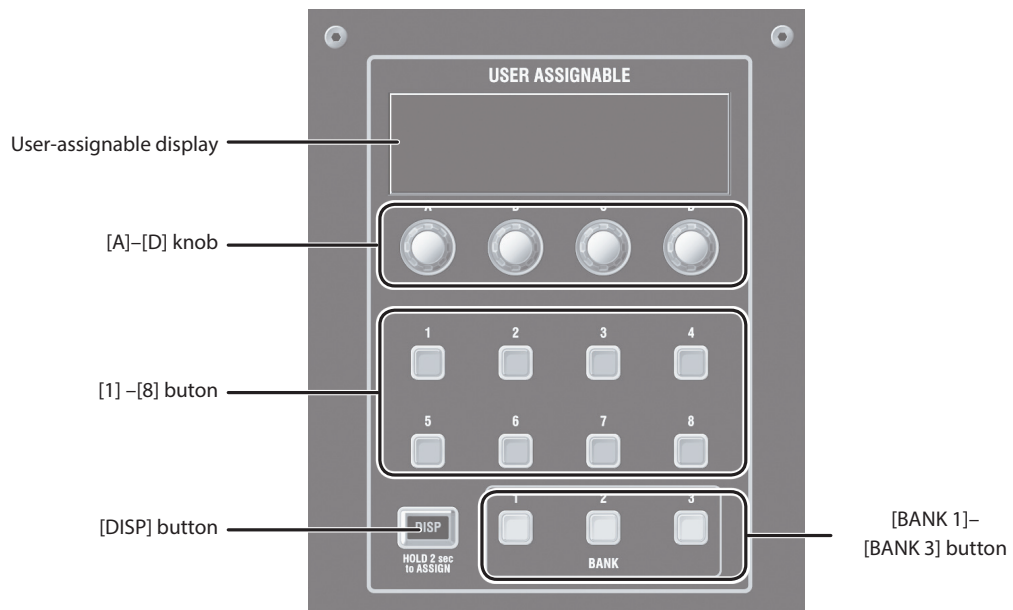

Name	Description
User-assignable display	This displays the parameters assigned to assignable knobs/buttons.
[A]–[D] knob	These manipulate the assigned parameter value.
[1]–[8] button	These turn assigned parameters on and off and access screens and windows.
[DISP] button	This displays the USER ASSIGNABLE SETUP window. Pressing and holding it for 2 seconds enters the assign mode. It flashes when in the assign mode.
[BANK 1]–[BANK 3] button	These changes banks in the user-assignable section.

Rear Panel

M-5000

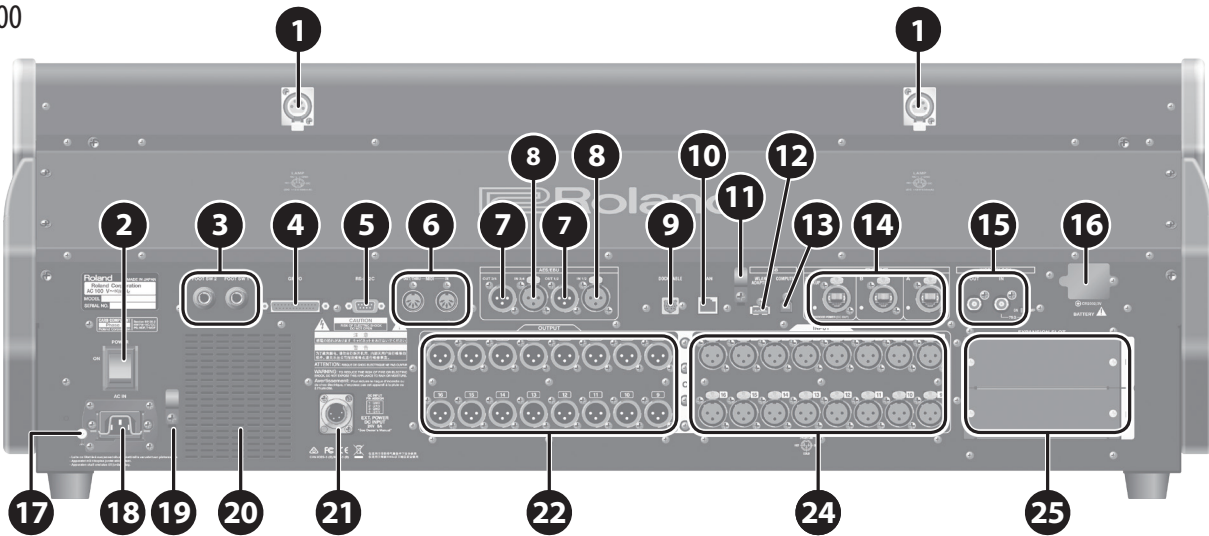

M-5000C

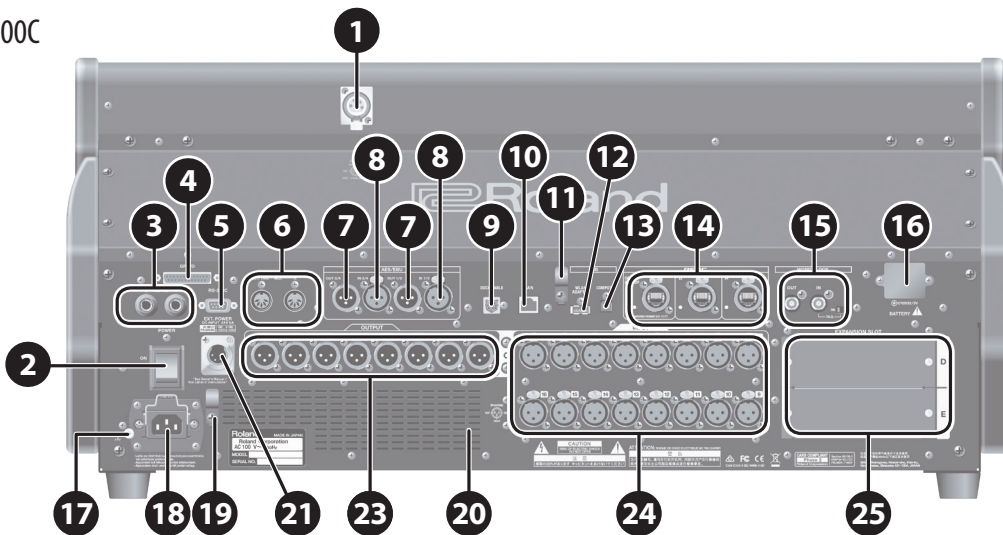

1 LAMP Connectors

These are XLR-4-31 connectors that supply power to third-party gooseneck lamps.

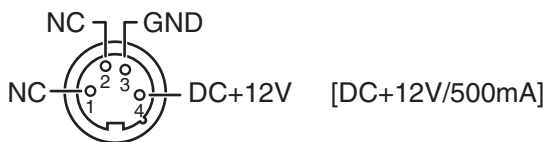

2 POWER Switch

This turns the power on and off.

→ “Turning the Power On and Off” (p. 20)

NOTE

If you need to turn off the power completely, first turn off the unit, then unplug the power cord from the power outlet. Refer to “To completely turn off power to the unit, pull out the plug from the outlet” (p. 4).

3 FOOT SW 1/2 Jacks

These are TRS standard jacks for connecting footswitch pedals.

Panneau arrière

M-5000

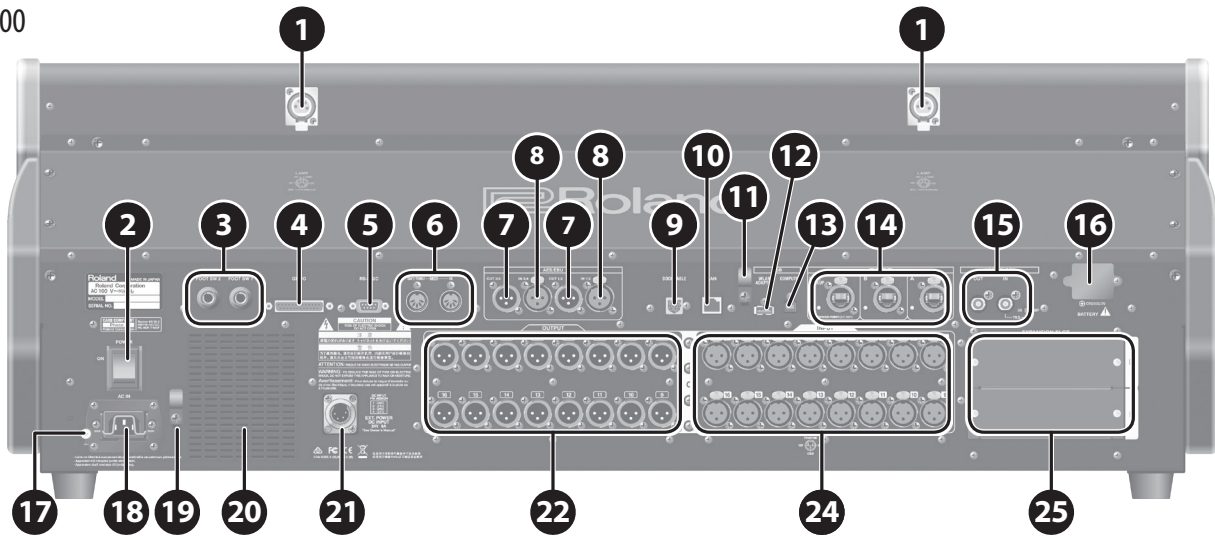

M-5000C

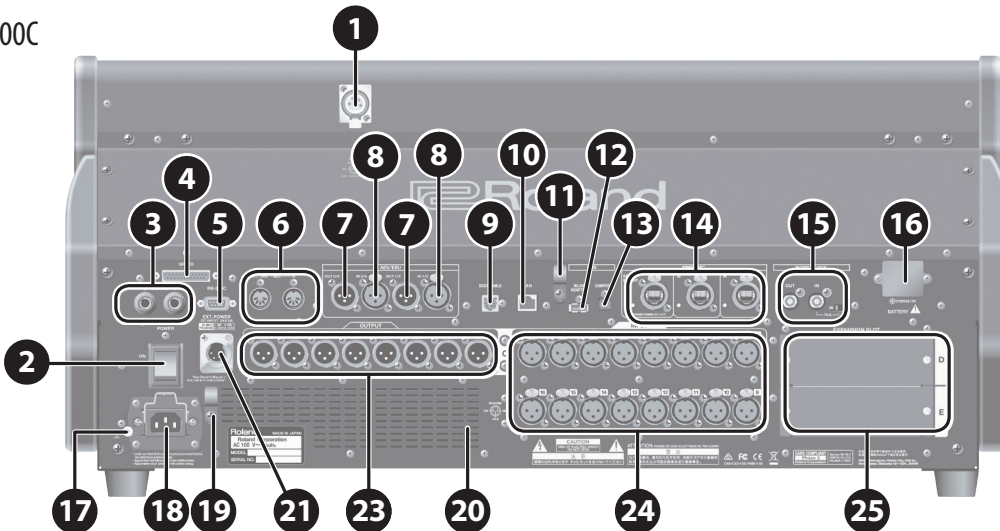

1 Connecteurs LAMP

Ce sont les connecteurs XLR-4-31 qui alimentent les lampes à col de cygne tierces.

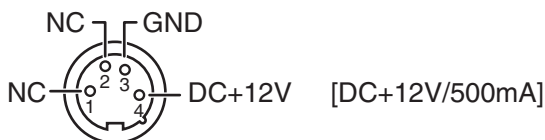

2 Commutateur d'alimentation POWER

Permet de mettre sous ou hors tension.

→ "Mise sous tension et hors tension de l'appareil" (p. 21)

NOTE

Si vous devez éteindre complètement l'alimentation, éteignez d'abord l'appareil avant de débrancher le cordon d'alimentation de la prise de courant. Consultez "Pour éteindre complètement l'alimentation de l'appareil, retirer la fiche de la prise" (p. 6).

3 Prises FOOT SW 1/2

Ce sont des prises standard TRS pour connecter les commutateurs au pied.

4 GP I/O Connector

This is a D-sub 25-pin connector (4 in/12 out) for sending and receiving control signals to and from an external device.

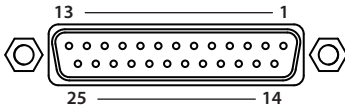

Connector No.	Type
1	GPO 1
2	GPO 3
3	GPO 5
4	GPO 7
5	GND
6	GND
7	GND
8	GND
9	+5V
10	GPI 2
11	GPI 4
12	GPO 10
13	GPO 12
14	GPO 2
15	GPO 4
16	GPO 6
17	GPO 8
18	GND
19	GND
20	GND
21	+5V
22	GPI 1
23	GPI 3
24	GPO 9
25	GPO 11

Input pin [Voltage detection range: 0-5V , Max +5V]
 Output pin [Open collector , Vmax=12V , Imax/pin=75 mA]
 DC output [DC+5V / 1000mA]

5 RS-232C Connector

You can use this RS-232C connector to control the M-5000 remotely from an external device.

Transmission method	Start-stop synchronization (asynchronous mode), full-duplex
Communication speed (baud rate)	4800, 9600, 14400, 31250, 38400, 57600, 115200 bps
Parity	None
Data length	8 bit
Stop-bit length	1 bit
Code set	ASCII

Connector No.	Signal name	Pin connections
1	NC	
2	RXD	
3	TXD	
4	DTR	
5	GND	
6	DSR	
7	RTS	
8	CTS	
9	NC	

M-5000	Computer
1: NC	1:
2: RXD	2: RXD
3: TXD	3: TXD
4: NC	4:
5: GND	5: GND
6: NC	6:
7: RTS	7:
8: CTS	8:
9: NC	9:

- * Pins 7 and 8 are connected inside the M-5000.
- * For the M-5000 to function, the three pins RXD, TXD, and GND must be connected as shown in the figure.
- * In addition to the owner's manual, RS-232C Reference Manual (PDF) is available as a reference material that covers RS-232C port control. Download the PDF file from the Roland website.
- * RS-232C Reference Manual (PDF) contains the following information.
 - Information on setup
 - Overviews, detailed explanations, and lists of commands

6 MIDI Connectors

These are connectors for attaching MIDI devices. An IN connector (for reception) and an OUT/THRU connector (for transmission and "thru") are provided.

7 AES/EBU OUT 1/2, AES/EBU OUT 3/4 Jacks

These jacks output digital audio signals in AES/EBU format (IEC60958-compliant).

8 AES/EBU IN 1/2, AES/EBU IN 3/4 Jacks

These jacks input digital audio signals in AES/EBU format (IEC60958-compliant).

NOTE

The AES/EBU IN 1/2 and AES/EBU IN 3/4 jacks are not equipped with a sampling-rate converter. Input digital audio signals synchronized to the M-5000's word clock.

9 DOCK CABLE Connector

This is for connecting an iPad using the dock cable included with the M-5000. This lets you operate the unit remotely and perform audio input and output on 2 channels using the iPad. Charging starts automatically when an iPad is connected.

10 LAN Port

This is an RJ45 connector for connecting a computer or Wi-Fi router. It lets you operate the M-5000 remotely using a computer or iPad.

11 LAN-cable Hook

This secures the LAN cable connected to the LAN port. This can help prevent inadvertent detachment of the LAN cable.
 → "Using the LAN-cable Hook" (p. 24)

12 USB WLAN ADAPTER Connector

This is a USB port for connecting a wireless USB adapter (WNA1100-RL, sold separately).
 It lets you connect an iPad, computer, or Wi-Fi router.

13 USB COMPUTER Connector

This is a USB port for connecting a computer.
 It lets you operate the M-5000 remotely and perform audio input and output on 16 channels.

14 REAC Ports (A B, SPLIT/BACKUP)

These are RJ45 connectors for attaching input/output units (such as the S-2416, S-1608, S-0816, and S-4000S) using Cat 5e Ethernet cables.

The unit has two series of REAC ports (A and B). The SPLIT/BACKUP port can split or duplicate the REAC A or B connection.

The REAC SPLIT/BACKUP port is compatible with REAC EMBEDDED POWER, and can supply power to devices compatible with REAC EMBEDDED POWER.

When a REAC device is connected, the system automatically detects whether the device is compatible with REAC EMBEDDED POWER and supplies power if compatible.

Power is not supplied if the device is not compatible with REAC EMBEDDED POWER.

4 Connecteur GP I/O

Il s'agit d'un connecteur D-sub à 25 broches (4 in/12 out) pour envoyer et recevoir des signaux de commande vers et depuis un dispositif externe.

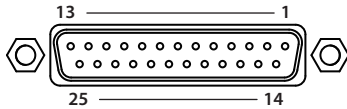

Connecteur No.	Type
1	GPO 1
2	GPO 3
3	GPO 5
4	GPO 7
5	GND
6	GND
7	GND
8	GND
9	+5V
10	GPI 2
11	GPI 4
12	GPO 10
13	GPO 12
14	GPO 2
15	GPO 4
16	GPO 6
17	GPO 8
18	GND
19	GND
20	GND
21	+5V
22	GPI 1
23	GPI 3
24	GPO 9
25	GPO 11

Broche d'entrée [Plage de détection de tension: 0-5V , Max +5V]
Broche de sortie [Collecteur ouvert, Vmax=12V , Imax/pin=75 mA]
DC sortie [DC+5V / 1000mA]

5 Connecteur RS-232C

Vous pouvez utiliser ce connecteur RS-232C pour contrôler le M-5000 à distance via un périphérique externe.

Méthode de transmission	Synchronisation Start-Stop (mode asynchrone), duplex intégral
Vitesse de communication (taux de transmission)	4800, 9600, 14400, 31250, 38400, 57600, 115200 bps
Parité	Aucune
Longueur de données	8 bits
Longueur Bit d'arrêt	1 bit
Jeu de codes	ASCII

Connecteur No.	Nom du signal	Connexions de broche
1	NC	
2	RXD	
3	TXD	
4	DTR	
5	GND	
6	DSR	
7	RTS	
8	CTS	
9	NC	

M-5000	Ordinateur
1 : NC	1 :
2 : RXD	2 : RXD
3 : TXD	3 : TXD
4 : NC	4 :
5 : GND	5 : GND
6 : NC	6 :
7 : RTS	7 :
8 : CTS	8 :
9 : NC	9 :

- * Les broches 7 et 8 sont connectées à l'intérieur du M-5000 .
- * Pour que le M-5000 fonctionne, les trois broches RXD, TXD et GND doivent être connectées comme indiqué sur la figure.
- * Outre le mode d'emploi, le Manuel de référence du V-Mixer RS-232C (PDF) est disponible en tant que document de référence concernant le port RS-232C. Téléchargez le fichier PDF sur le site Roland.
- * Le Manuel de référence du RS-232C (PDF) contient les informations suivantes.
 - Informations sur la configuration
 - Aperçus, explications détaillées et listes de commandes

6 Connecteurs MIDI

Ces connecteurs servent à la connexion des périphériques MIDI. Un connecteur IN (pour la réception) et un connecteur OUT/THRU (pour la transmission et "THRU") sont fournis.

7 Prises AES/EBU OUT 1/2, AES/EBU OUT 3/4

Ces prises assurent la sortie des signaux audio numériques au format AES/EBU (conformité IEC60958).

8 Prises AES/EBU IN 1/2, AES/EBU IN 3/4

Ces prises assurent l'entrée des signaux audio numériques au format AES/EBU (conformité IEC60958).

NOTE

Les prises AES/EBU IN 1/2 et AES/EBU IN 3/4 ne sont pas équipées d'un convertisseur de taux d'échantillonnage. Les signaux audio numériques d'entrée sont synchronisés avec l'horloge du M-5000.

9 Connecteur DOCK CABLE

Il sert à connecter un iPad via le câble dock fourni avec le M-5000. Cela vous permet d'utiliser l'appareil à distance et d'effectuer l'entrée et la sortie audio sur 2 canaux via un iPad. Le chargement démarre automatiquement quand un iPad est connecté.

10 Port LAN

Il s'agit d'un connecteur RJ45 pour le raccordement d'un ordinateur ou d'un routeur Wi-Fi. Il vous permet d'utiliser le M-5000 à distance via un ordinateur ou un iPad.

11 Crochet de câble LAN

Il immobilise le câble réseau connecté au port LAN. Il permet de prévenir le détachement accidentel du câble réseau. 0"Utilisation du crochet de câble réseau" (p. 25)

12 Connecteur USB WLAN ADAPTER

Il s'agit d'un port USB pour connecter un adaptateur USB sans fil (WNA1100-RL, vendu séparément). Il vous permet de connecter un iPad, un ordinateur ou un routeur Wi-Fi.

13 Connecteur USB COMPUTER

Il s'agit d'un port USB pour la connexion d'un ordinateur. Il vous permet d'utiliser le M-5000 à distance et d'effectuer l'entrée et la sortie audio sur 16 canaux.

15 WORD CLOCK IN/OUT Connectors

These are connectors for word-clock input and output. To terminate word-clock input at the M-5000, set the 75 ohms switch to ON.

16 BATTERY Slot

This slot contains a lithium battery that maintains the M-5000's clock function and preserves the mixer settings. If the battery runs down, you need to replace it.

→ "Replacing the Internal Lithium Battery" (p. 22)

17 Ground Terminal

This terminal is used to connect the M-5000 to an electrical ground.

* Depending on the circumstances of a particular setup, you may experience a discomforting sensation, or perceive that the surface feels gritty to the touch when you touch this device, microphones connected to it, or the metal portions of other objects, such as guitars. This is due to an infinitesimal electrical charge, which is absolutely harmless. However, if you are concerned about this, connect the ground terminal (see figure) with an external ground. When the unit is grounded, a slight hum may occur, depending on the particulars of your installation. If you are unsure of the connection method, contact the nearest Roland Service Center, or an authorized Roland distributor, as listed on the "Information" page.

Unsuitable places for connection

- Water pipes (may result in shock or electrocution)
- Gas pipes (may result in fire or explosion)
- Telephone-line ground or lightning rod (may be dangerous in the event of lightning)

18 AC INPUT Connector, Power-cord Clamp

This connector is for attaching the included power cord. To keep the power cord from being inadvertently disconnected, you use the power-cord clamp to secure the cord in place.

- "Connecting the Power Cord" (p. 16)
- "Using the Power-cord Clamp" (p. 16)
- "To completely turn off power to the unit, pull out the plug from the outlet" (p. 4)

19 Power-cord Hook

You can use this power cord hook to prevent the power cord from being accidentally disconnected.

→ "Using the Power-cord Hook" (p. 18)

20 Cooling Fan

This is the fan for cooling the M-5000. When placing the M-5000, be careful not to obstruct the ventilation holes.

21 EXT. POWER DC INPUT Connector

This connector is for attaching an optional S-240P external power-supply unit to supply backup power to the M-5000.

If an S-240P External Power Supply Unit is providing power to the M-5000, the M-5000 will keep operating even if the power switch is in the OFF position.

* DC INPUT [DC+24V / 6A]

NOTE

To avoid damage or injury, never connect anything to the EXT. POWER DC INPUT jack except the DC output of the S-240P External Power Supply Unit.

22 OUTPUT 1-16 Connectors (M-5000 only)

These are male balanced XLR-3-32 output connectors for sending analog audio signals.

* Make connections after first checking the wiring diagrams of other equipment you intend to connect.

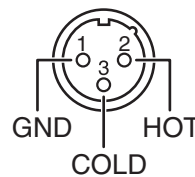

23 OUTPUT 1-8 Connectors (M-5000C only)

These are male balanced XLR-3-32 output connectors for sending analog audio signals.

* Make connections after first checking the wiring diagrams of other equipment you intend to connect.

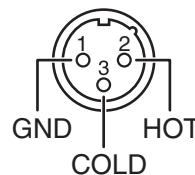

24 INPUT 1-16 Connectors

These are female balanced XLR-3-31 input connectors for incoming analog audio signals from microphones and line-level equipment.

* Make connections after first checking the wiring diagrams of other equipment you intend to connect.



NOTE

Always turn the phantom power off when connecting any device other than condenser microphones that require phantom power. You risk causing damage if you mistakenly supply phantom power to dynamic microphones, audio playback devices, or other devices that don't require such power. Be sure to check the specifications of any microphone you intend to use by referring to the manual that came with it. (This instrument's phantom power: DC+48 V, 14 mA Max)

25 EXPANSION SLOT

This slot is for installing an optional expansion interface.

* When restarting the unit with the expansion interface installed, wait for about one second before you turn on the power.

→ "Installing an Expansion Interface (Option)" (p. 24)

14 Ports REAC (A, B, SPLIT/BACKUP)

Il s'agit de connecteurs RJ45 pour la fixation des unités d'entrée/sortie (comme le S-2416, S-1608, S-0816 et S-4000S) à l'aide de câbles Ethernet Cat 5e.

L'unité est dotée de deux séries de ports REAC (A et B). Le port SPLIT/BACKUP peut diviser ou dupliquer la connexion REAC A ou B.

Le port REAC SPLIT/BACKUP est compatible avec REAC EMBEDDED POWER (alimentation intégrée REAC), et peut alimenter des appareils compatibles avec REAC EMBEDDED POWER.

Quand un appareil REAC est connecté, le système détecte automatiquement si cet appareil est compatible avec REAC EMBEDDED POWER et l'alimente le cas échéant.

L'alimentation n'est pas fournie si l'appareil n'est pas compatible avec REAC EMBEDDED POWER.

15 Connecteurs WORD CLOCK IN/OUT

Il s'agit des connecteurs pour l'entrée et la sortie de l'horloge. Pour mettre fin à l'entrée d'horloge du M-5000, commuter l'interrupteur 75 ohms sur ON.

16 Logement BATTERY

Ce logement contient une pile au lithium qui fait fonctionner l'horloge du M-5000 et conserve les réglages de la console. Si la pile est déchargée, elle doit être remplacée.

→ "Remplacement de la pile au lithium interne" (p. 23)

17 Borne de terre

Cette borne est utilisée pour connecter le M-5000 à une masse électrique.

* En fonction de votre installation, il est possible que vous éprouviez un certain inconfort ou que vous perceviez une rugosité en touchant la surface de l'amplificateur, des microphones connectés ou des parties métalliques d'autres objets, tels que les guitares, par exemple. Ce phénomène est dû à de petites charges électriques, absolument sans danger. Pour y remédier, vous pouvez relier la prise de terre (voir l'illustration) à une prise de terre extérieure. Lorsque l'appareil est ainsi connecté, un léger bourdonnement peut apparaître, en fonction de l'installation. Si vous n'êtes pas certain du mode de connexion à établir, prenez contact avec le centre de maintenance Roland le plus proche, ou avec un distributeur Roland agréé comme indiqué sur la page "Informations".

Environnements déconseillés

- Conduites d'eau (risque de choc électrique ou d'électrocution)
- Conduites de gaz (risque d'incendie ou d'explosion)
- Masse de ligne téléphonique ou paratonnerre (dangereux en cas de foudre)

18 Connecteur AC INPUT, Attache du cordon d'alimentation

Ce connecteur permet de raccorder le cordon d'alimentation fourni. Afin d'éviter que le cordon d'alimentation ne soit déconnecté par inadvertance, veuillez utiliser l'attache du cordon d'alimentation pour fixer le cordon en place.

→ "Connexion du cordon d'alimentation" (p. 17)

→ "Utilisation de l'attache du cordon d'alimentation" (p. 17)

→ "Pour éteindre complètement l'alimentation de l'appareil, retirer la fiche de la prise" (p. 6)

19 Crochet du cordon d'alimentation

Vous pouvez utiliser ce Crochet du cordon d'alimentation pour éviter la déconnexion accidentelle du cordon d'alimentation.

→ "Utilisation du Crochet du cordon d'alimentation" (p. 19)

20 Ventilateur de refroidissement

Il s'agit du ventilateur de refroidissement du M-5000. Lorsque vous placez le M-5000, veillez à ne pas obstruer ses orifices de ventilation.

21 Connecteur EXT. POWER DC INPUT

Ce connecteur permet de brancher une unité d'alimentation externe S-240P optionnelle comme alimentation de secours du M-5000.

Si une unité d'alimentation externe S-240P alimente le M-5000, le M-5000 va continuer à fonctionner même si l'interrupteur d'alimentation est en position OFF.

* DC INPUT [DC+24V / 6A]

NOTE

Pour éviter tout dommage ou blessure, ne jamais brancher quoi que ce soit à la prise EXT. POWER DC INPUT à l'exception de la sortie DC de l'unité d'alimentation externe S-240P.

22 Connecteurs OUTPUT 1-16 (M-5000 uniquement)

Il s'agit de connecteurs de sortie symétriques XLR-3-32 mâles pour les signaux audio analogiques sortants.

* Effectuez les connexions après avoir préalablement vérifié les schémas de câblage des équipements que vous souhaitez connecter.

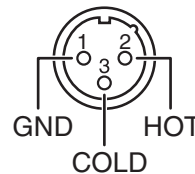

23 Connecteurs OUTPUT 1-8 (M-5000C seulement)

Il s'agit de connecteurs de sortie symétriques XLR-3-32 mâles pour les signaux audio analogiques sortants.

* Effectuez les connexions après avoir préalablement vérifié les schémas de câblage des équipements que vous souhaitez connecter.

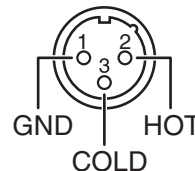

24 Connecteurs INPUT 1-16

Il s'agit de connecteurs d'entrée symétriques XLR-3-31 femelles pour les signaux audio analogiques entrants des micros et des équipements de niveau ligne.

* Effectuez les connexions après avoir préalablement vérifié les schémas de câblage des équipements que vous souhaitez connecter.

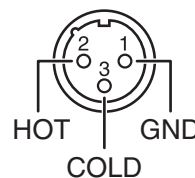

+PHANTOM [+48V/14mA]

NOTE

Toujours éteindre l'alimentation fantôme avant de brancher tout autre appareil qu'un microphone à condensateur nécessitant une alimentation fantôme. Vous risquez de provoquer des dommages si vous fournissez à tort une alimentation fantôme à des micros dynamiques, des appareils de lecture audio ou d'autres appareils qui ne nécessitent pas une telle alimentation. Assurez-vous de vérifier les spécifications de tout microphone que vous souhaitez utiliser en vous référant au manuel qui l'accompagne.

(Alimentation fantôme de cet instrument : DC+48 V, 14 mA Max)

Front Panel



1 PHONES 1/2 Jacks

These are jacks for connecting headphones. You can use them to monitor the MONITOR 1 or MONITOR 2 audio. Two outputs are provided: miniature stereo phone type and stereo 1/4-inch phone type. Ensure that the total impedance of both is less than 16 ohms.

2 PHONES LEVEL Knob

This adjusts the output level for headphones connected to the PHONES jacks.

3 TALKBACK MIC 2 Jack

This is a female balanced XLR-3-31 input connector for connecting an external microphone for talkback use.

* Make connections after first checking the wiring diagrams of other equipment you intend to connect.

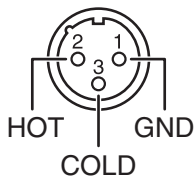

+PHANTOM [+48V/14mA]

NOTE

Always turn the phantom power off when connecting any device other than condenser microphones that require phantom power. You risk causing damage if you mistakenly supply phantom power to dynamic microphones, audio playback devices, or other devices that don't require such power. Be sure to check the specifications of any microphone you intend to use by referring to the manual that came with it.

(This instrument's phantom power: DC+48 V, 14 mA Max)

25 EXPANSION SLOT

Cet emplacement sert à l'installation d'une interface d'extension en option.

- * Lors du redémarrage de l'unité avec l'interface d'extension installée, attendre pendant environ une seconde avant la mise sous tension.
- "Installation d'une interface d'extension (en option)" (p. 25)

Panneau avant



1 Prises PHONES 1/2

Il s'agit de prises pour brancher un casque. Vous pouvez les utiliser pour le contrôle audio du MONITOR 1 ou MONITOR 2. Deux sorties sont disponibles : stéréo miniature de type téléphone et stéréo 1/4 pouces type téléphone. Assurez-vous que l'impédance totale des deux est de moins de 16 ohms.

2 Molette PHONES LEVEL

Elle permet de régler le niveau de sortie pour les écouteurs connectés aux prises PHONES.

3 Prise TALKBACK MIC 2

Il s'agit d'un connecteur d'entrée symétrique XLR-3-31 femelle pour connecter un microphone externe pour une utilisation de la fonction talkback.

- * Effectuez les connexions après avoir préalablement vérifié les schémas de câblage des équipements que vous souhaitez connecter.

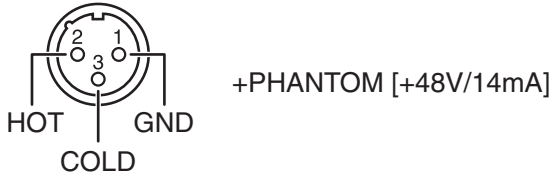

NOTE

Toujours éteindre l'alimentation fantôme avant de brancher tout autre appareil qu'un microphone à condensateur nécessitant une alimentation fantôme. Vous risquez de provoquer des dommages si vous fournissez à tort une alimentation fantôme à des micros dynamiques, des appareils de lecture audio ou d'autres appareils qui ne nécessitent pas une telle alimentation. Assurez-vous de vérifier les spécifications de tout microphone que vous souhaitez utiliser en vous référant au manuel qui l'accompagne.

(Alimentation fantôme de cet instrument : DC+48 V, 14 mA Max)

Overview of Operations

This section describe typical procedures for operating the M-5000. For more information about the operation procedures, refer to the Reference Manual (PDF).

Basic Operations of Fader Bank Section

Changing Layers

Fader Bank Section

On the M-5000, operations are carried out using groups of eight faders. Each set of eight faders is called a “fader bank.”

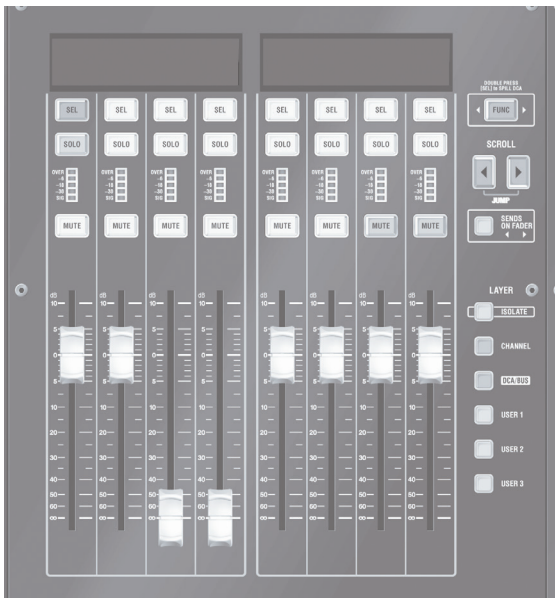

The M-5000 is provided with three fader banks and the M-5000C is provided with two fader banks. You can operate the respective fader banks in an interlinked way or independently, enabling you to carry out your intended operations instantly.

1. Press a layer button to switch to the desired layer.

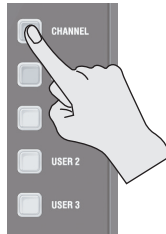

If you pressed the button at a “Normal bank” (p. 48), other normal banks also change in an interlinked way.

If an isolated bank has been pressed, only that isolated bank is switched.

Layer button	Description
[CHANNEL]	This accesses the input-channel layer.
[DCA/BUS]	This accesses the layer of the DCA group master and the output buses (MAIN, SUBGROUP, AUX, MIX-MINUS, and MATRIX). These access user-assigned channels.
[USER 1]–[USER 3]	You can assign up to 64 at a time for each layer.

Layers

Each fader bank has two basic layers (CHANNEL and DCA/BUS) and three customizable layers (USER 1 through 3) that you can switch between according to purpose.

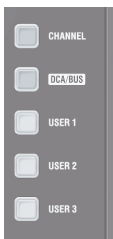

Scrolling the Channels

1. Press the [SCROLL ◀] or [SCROLL ▶] button to scroll the channels.

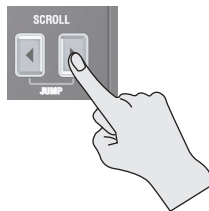

The channels assigned to the fader bank section in the selected layer are switched in groups of eight.

MEMO

If you pressed the button at a “Normal bank” (p. 48), other normal banks also change in an interlinked way.

MEMO

Scrolling by one channel at a time when the [SHIFT] button is on.

Scrolling

Pressing the [SCROLL ◀] or [SCROLL ▶] button shifts the channels accessed by the fader bank in the currently selected layer by eight channels at a time.



Anchor Channels

You can mark channels you want to access rapidly in the various layers. These are called “anchor channels.” Specifying anchor channels in the respective layers lets you quickly jump to the desired channel. You can register up to 8 anchor channels in each layer.

MEMO

In the settings, preset anchors are present in the CHANNEL layer at every 24th channel and in the DCA/BUS layer by channel type (DCA, MAIN, SUBGROUP, and the like).

Accessing an Anchor Channel (Anchor Jump)

1. Press [SCROLL ◀] and [SCROLL ▶] at the same time.

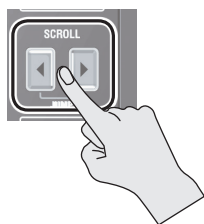

Anchor channels registered in the currently selected layer are shown on the fader bank display.

2. Press the [SEL] button that corresponds to the desired anchor channel.

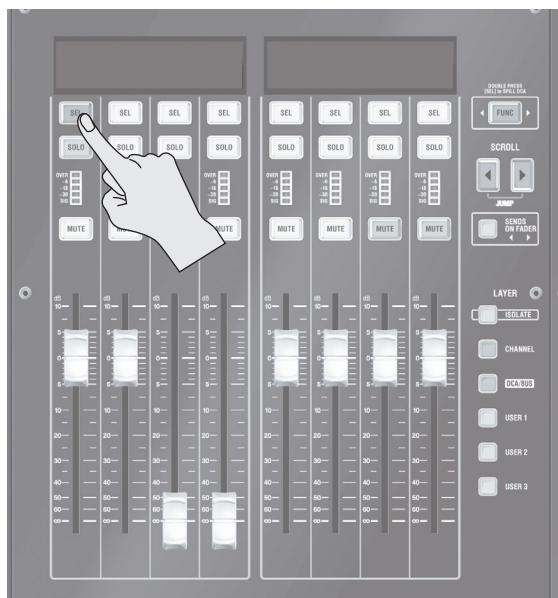

The fader bank scrolls to the location where the anchor channel is displayed in the leftmost fader.

Accessing Adjacent Anchor Channels

Pressing and holding the [SCROLL ◀] or [SCROLL ▶] button scrolls forward or backward to the anchor channel nearest the currently accessed channel.

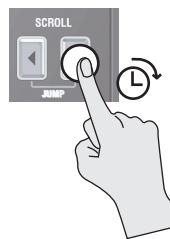

Isolated Banks

A fader bank whose [ISOLATE] button has been turned on is called an "isolated bank." Using isolated banks makes it possible to configure a wide variety of fader layouts, such as arranging a CHANNEL layer and DCA/BUS layer side by side at the same time.



[ISOLATE]	Term	Description
Off (dark)	Normal bank	The bank operates in an interlinked fashion with other normal banks. When layer-switching or scrolling is performed in this normal bank, the earlier or later channel in other normal banks is also accessed.
On (lighted)	Isolated bank	This bank is isolated from other fader banks. In an isolated bank, layer-switching and scrolling can be performed independently of other fader banks.

Usage Examples

	<p>All banks are set to be normal banks. This allows access to, for example, 24 input-channel faders.</p>
<p style="text-align: center;">ISOLATED</p>	<p>One bank is set as an isolated bank. This allows access to, for example, 16 input-channel faders and 8 output-bus faders.</p>
<p style="text-align: center;">ISOLATED ISOLATED</p>	<p>Two banks are set as isolated banks. This allows access to, for example, 8 input-channel faders, 8 DCA faders, and 8 other input-channel faders.</p>

(The M-5000 is depicted.)

Isolating a Fader Bank

1. At the desired fader bank, press the [ISOLATE] button to turn it on (lighted).

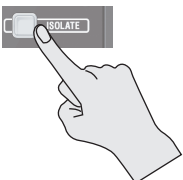

The target fader bank is isolated.

Unisolating a Fader Bank

1. Press the [ISOLATE] button to turn it off (dark).

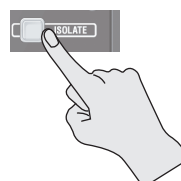

If one or more other normal banks exist, each switches to the same layer, and the same earlier or later channel is accessed.

Basic Touch Operations

The following four operations are used when working with the touch display.

Tap

Using your fingertip, you press and release an on-screen button, area, or other item.



Double-tap

You make two taps in rapid succession.



Long tap

You touch and hold your fingertip to the touch display for a specific interval before release.



Slide

You drag your fingertip across the touch display while pressing and holding it against a target item.



Using Templates to Select a Mixer Configuration

The configuration of the mixing engine in the M-5000 can be changed as you like to suit the desired purpose. This section describes selecting a mixer configuration from templates.

1. Press the [MENU] button.
2. Tap <SETUP>, then tap <MIXER CONFIGURATION>. The MIXER CONFIGURATION window appears.



3. Tap <TEMPLATE>. The TEMPLATE popover appears.
4. Tap <DEFAULT>. Starting point templates for the mixer configurations are available. The Default configuration has the following:
 - INPUT CHANNEL (MONO): 64
 - INPUT CHANNEL (STEREO): 4
 - MAIN: LCR
 - AUX: 24
 - MATRIX: 8
 - MONITOR 1 (STEREO)
 - TALKBACK
 - OSC 1+OSC 2
 - HEADPHONES (STEREO)
 - (The remains of channel strips: 14)
5. Turn on the <STEREO> button for any input channel or output bus you want to make stereo.
6. Tap <OK>.

HOME Screen

The HOME screen appears at startup.

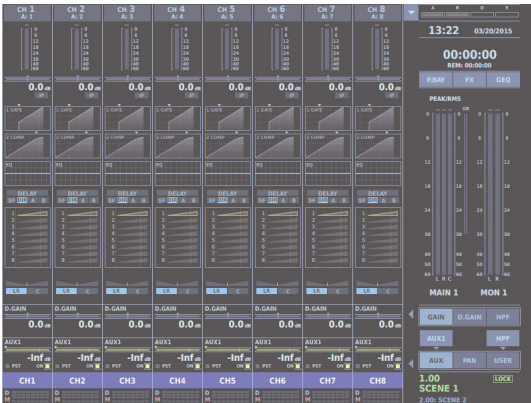

When other window is displayed, to close the window and display the HOME screen, press the [VIEW] button.

This quits the window, attendant popovers, and attendant popups and displays the HOME screen.

(Excludes the MIXER CONFIGURATION window)

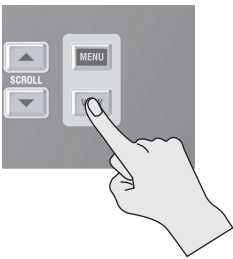

Access the CH EDIT window

1. On the HOME screen, tap areas shown below.

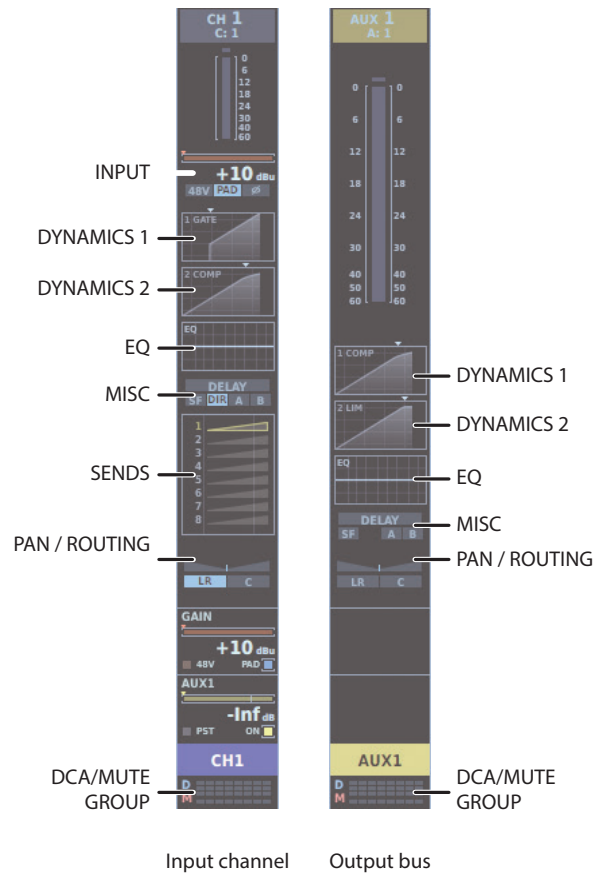

The CH EDIT window appears.

For details on how to work with the CH EDIT window, refer to the "CH EDIT Window" section in the Reference Manual (PDF).

Selecting the Source for an Input Channel

1. Access the CH EDIT window for the desired input channel.
→ "Access the CH EDIT window" (p. 50)
2. Tap the <INPUT tab>.

INPUT tab

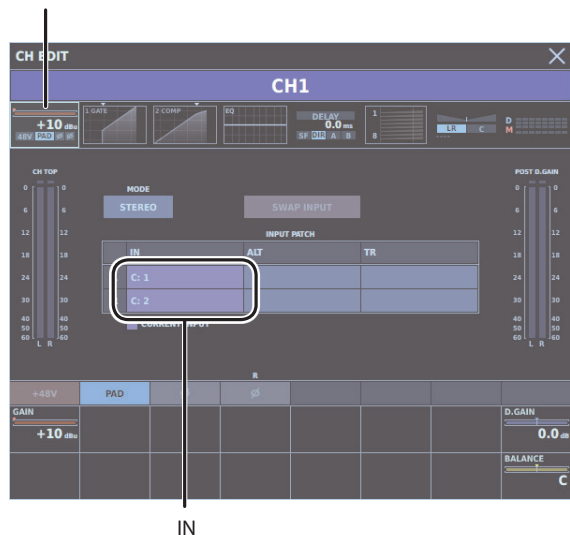

IN

3. Tap <IN>.
The SOURCE popover appears.

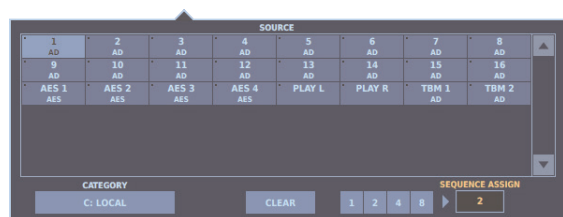

4. Tap <CATEGORY> and select the source type.
5. Select the desired source.

Selecting the Destination for an Output Bus

1. Access the CH EDIT window for the desired output bus.
→ "Access the CH EDIT window" (p. 50)
2. Tap the <OUTPUT tab>.

OUTPUT tab

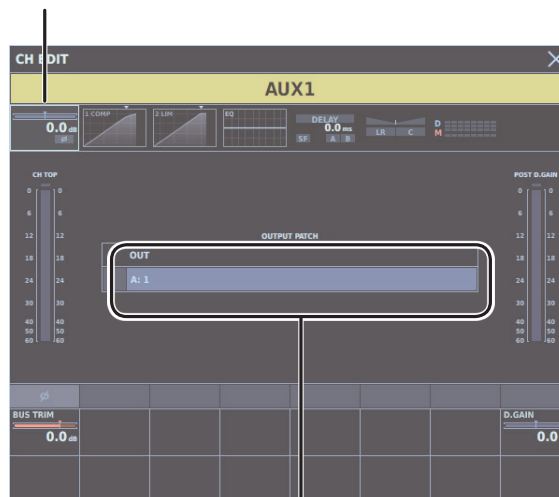

OUT

3. Tap <OUT>.
The DESTINATION popover appears.

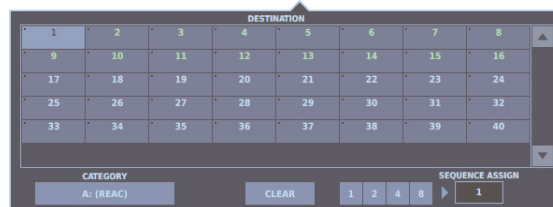

4. Tap <CATEGORY> and select the output-destination type.
5. Select the desired output destination.

Turning Phantom Power On or Off

1. Access the CH EDIT window for the desired input channel.
→ "Access the CH EDIT window" (p. 50)
2. Tap the <INPUT tab>.

INPUT tab

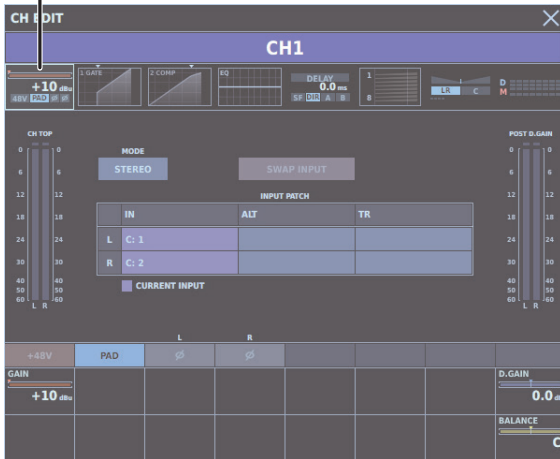

3. Tap <+48V>.

* Always turn the phantom power off when connecting any device other than condenser microphones that require phantom power. You risk causing damage if you mistakenly supply phantom power to dynamic microphones, audio playback devices, or other devices that don't require such power. Be sure to check the specifications of any microphone you intend to use by referring to the manual that came with it. (This instrument's phantom power: DC+48 V, 14 mA Max)

MEMO

To prevent occurrence of noise, input is briefly muted when phantom power is turned on or off.

Adjusting the Preamp Gain

1. On the HOME screen, go to the knob-assign area and tap <GAIN>.



knob-assign area

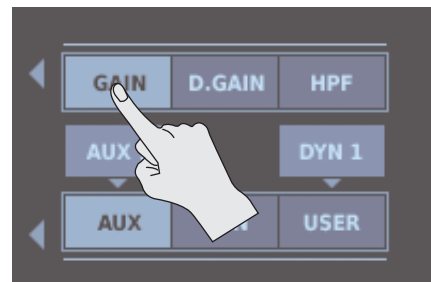

2. Adjust the preamp gain in the top row of the knob section.

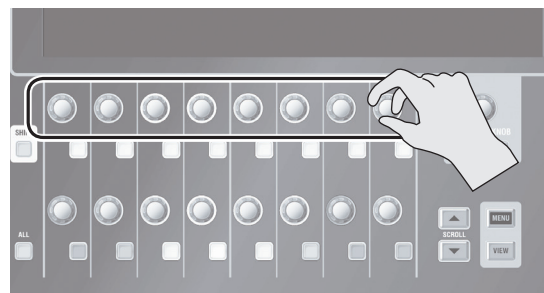

Applying Dynamics

1. Access the CH EDIT window.
→ "Access the CH EDIT window" (p. 50)
2. Tap the <DYNAMICS 1 tab> or <DYNAMICS 2 tab>.

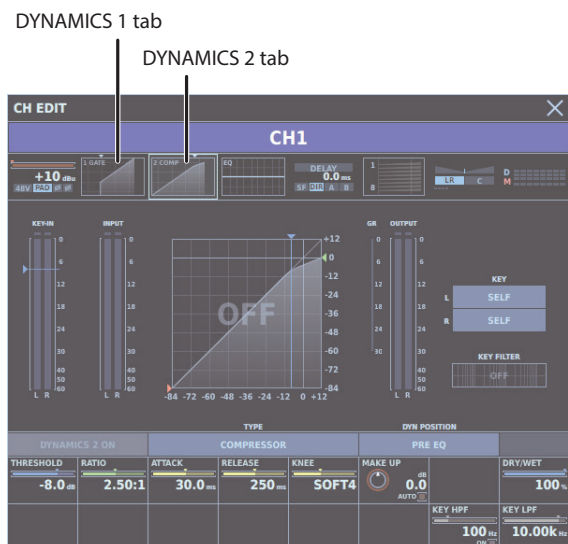

3. Tap <TYPE> and select the dynamics type.
4. Tap <DYNAMICS 1 ON> or <DYNAMICS 2 ON> to turn it on.
5. Carry out operations using the touch display and knob section.

Applying EQ

1. Access the CH EDIT window.
→ "Access the CH EDIT window" (p. 50)
2. Tap the <EQ tab>.

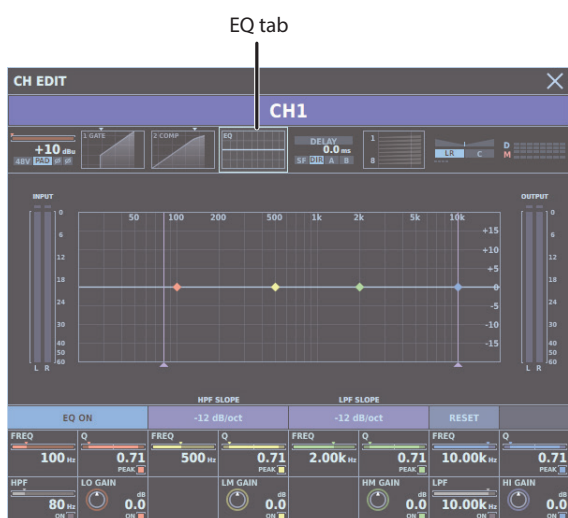

3. Carry out operations using the touch display and knob section.

Using Faders to Adjust the Send Level to AUX (SENDS ON FADER)

Using SENDS ON FADER lets you use faders to adjust the send level to AUX.

MEMO

SENDS ON FADER is applied to all fader banks.

1. On the HOME screen, go to the knob-assign area and tap <AUX TARGET>.

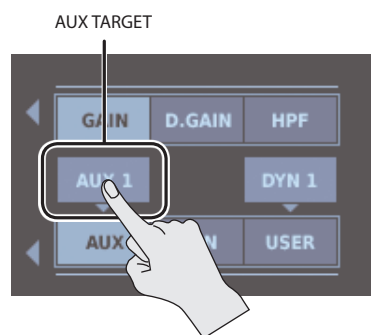

2. On the SELECT AUX SENDS window, select the AUX that you want to adjust the send levels to.

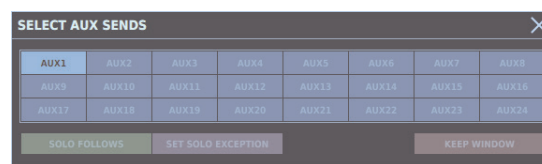

3. Press the [SENDS ON FADER] button to turn it on (flashing).

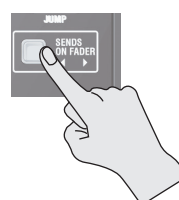

The SENDS ON FADER mode is activated, and you can use faders to adjust the send level to AUX selected in step 2.

4. Use the faders to adjust the send level.
To change the AUX you are sending to, carry out steps 1 and 2 again.

MEMO

- If an AUX has been assigned to the fader bank, you can change the destination AUX by pressing the corresponding [SEL] button.

Sending to SUBGROUP/MIX-MINUS

This sends an input channel to a SUBGROUP or MIX-MINUS.

MEMO

MIX-MINUS lets you mix a specific channel pulled from MAIN. By default, all input channels are sent with POST FDR (on), with only necessary channels turned off.

1. Access the CH EDIT window.
→ "Access the CH EDIT window" (p. 50)
2. Tap the <PAN/ROUTING tab>.

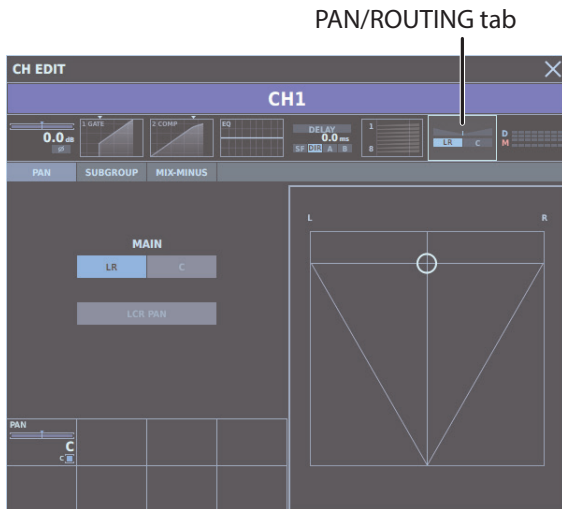

3. Tap <SUBGROUP tab> or <MIX MINUS tab>.

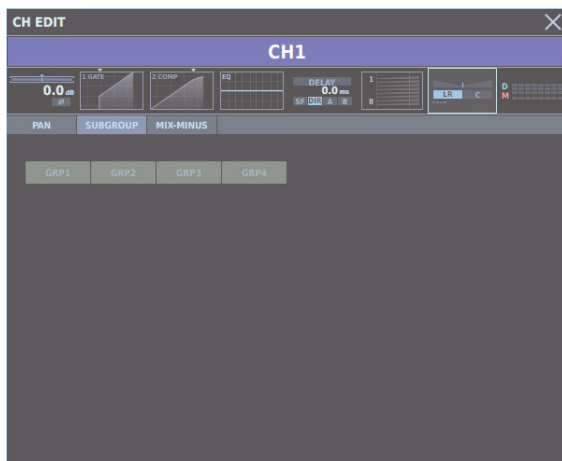

4. Select the SUBGROUP or MIX-MINUS you want to send.

Using an FX with Send/Return

1. On the HOME screen, tap <FX>.



The FX RACK window appears.



Eight sets of effect racks are displayed.

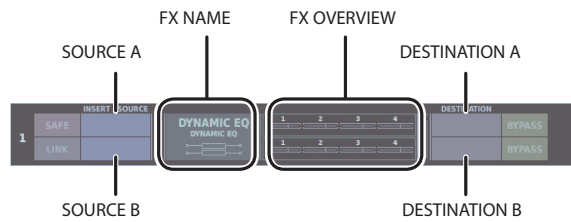

2. Tap <SOURCE A> or <SOURCE B>.

The SOURCE popover appears.

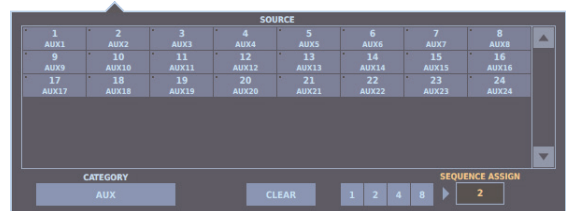

3. Select the AUX to send to the FX.

4. Tap <DESTINATION A> or <DESTINATION B>.

The DESTINATION popover appears.

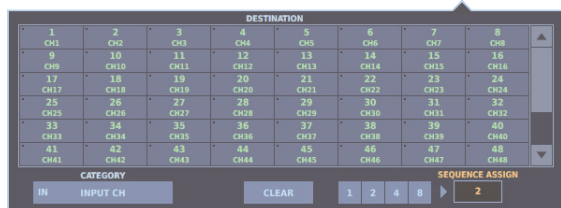

5. Select the input channel for returning the FX.

6. Tap <FX NAME> and select the effect library.

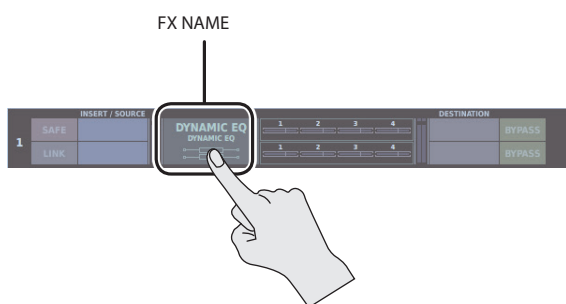

7. Tap <FX OVERVIEW>.

The FX EDIT window appears.



8. Carry out operations using the touch display and knob section.

Inserting an FX

This inserts an FX at INSERT A or INSERT B on an input channel or output bus.

INSERT A is inserted before dynamics and EQ, and INSERT B is inserted after dynamics and EQ.

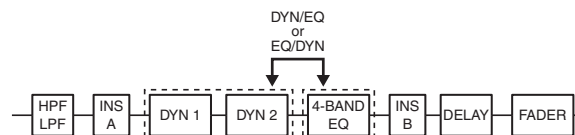

1. Access the CH EDIT window.

→ “Access the CH EDIT window” (p. 50)

2. Tap the <MISC tab>.

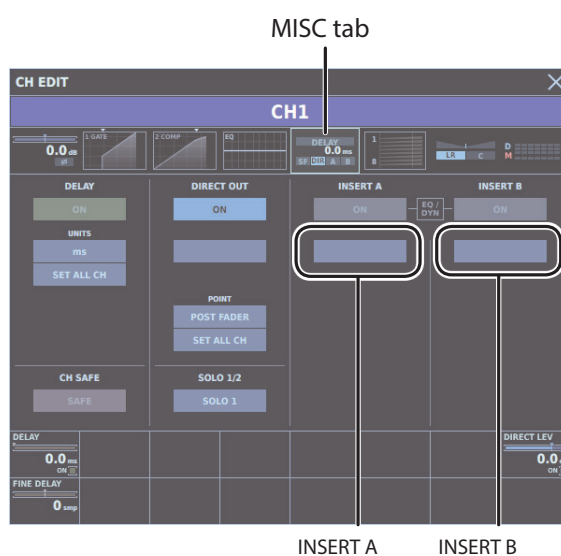

3. Tap <INSERT A> or <INSERT B>, then select the number of the FX to insert.



MEMO

If the input channel or output bus is stereo, you can make insertions at the following four locations.

- <INSERT A - L>
- <INSERT A - R>
- <INSERT B - L>
- <INSERT B - R>

4. Tap INSERT A <ON> or INSERT B <ON>.

The selected FX is inserted.

5. On the HOME screen, tap <FX>.

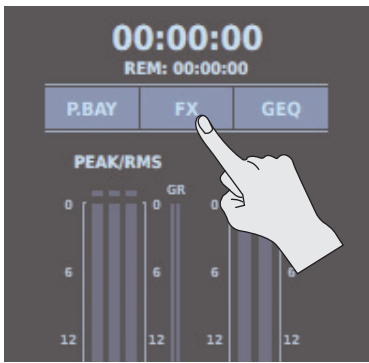

The FX RACK window appears.

6. Tap <FX NAME> and select the effect library.

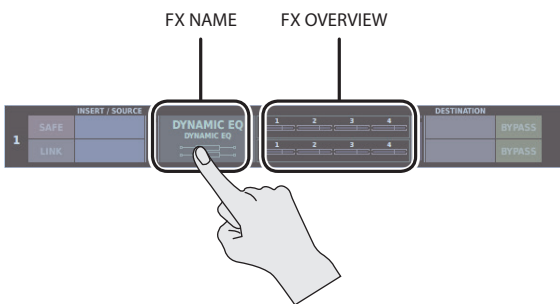

7. Tap <FX OVERVIEW>.

The FX EDIT window appears.

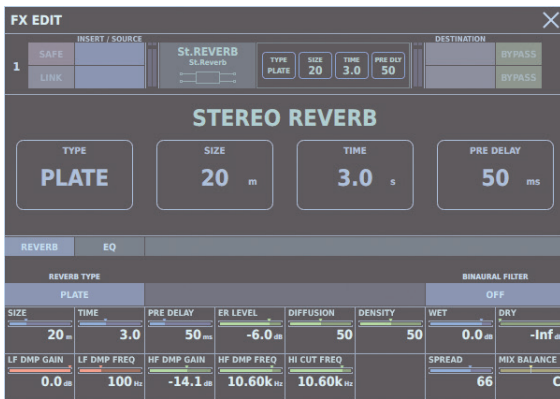

8. Use the touch display and knob section to make detailed adjustments.

Inserting a GEQ

This inserts a GEQ at INSERT A or INSERT B.

INSERT A is inserted before the dynamics and EQ, and INSERT B is inserted after the dynamics and EQ.

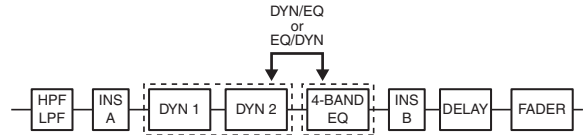

1. Access the CH EDIT window.

→ "Access the CH EDIT window" (p. 50)

2. Tap the <MISC tab>.

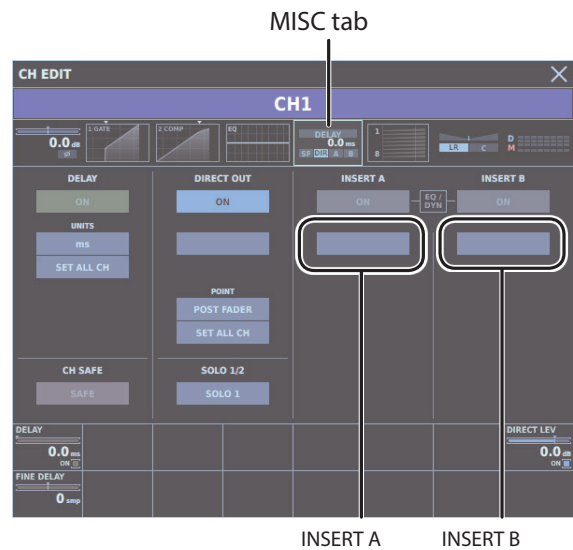

3. Tap <INSERT A> or <INSERT B>.

The INSERT popover appears.

4. Tap <CATEGORY> and select the effect category <GEQ>, then select the number of the GEQ to insert.

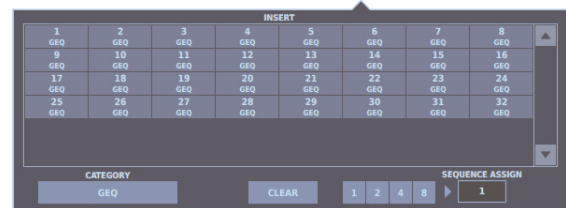

5. Tap INSERT A <ON> or INSERT B <ON>.

The selected GEQ is inserted.

MEMO

If the input channel or output bus is stereo, you can make insertions at the following four locations.

- <INSERT A - L>
- <INSERT A - R>
- <INSERT B - L>
- <INSERT B - R>

6. On the HOME screen, tap <GEQ>.

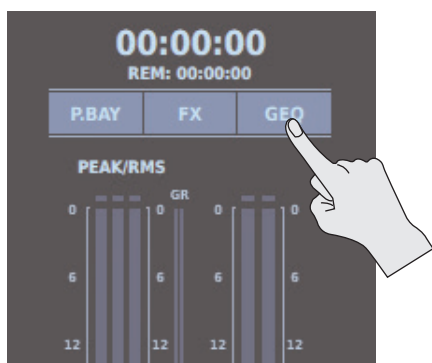

The GEQ window appears.

7. Tap a tab from <GEQ 1> to <GEQ 32>, then use the touch display and knob section to make detailed adjustments.

<GEQ 1> - <GEQ 32>

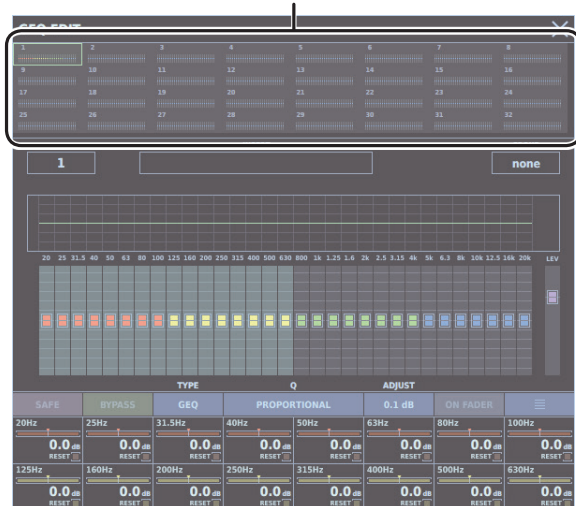

Linking Channels

You can link multiple input channels or output buses into up to 12 groups.

The parameters of linked input channels or output buses are set to the same values. You can select the parameters to link.

1. Press the [MENU] button.
2. On the MENU window, tap <SETUP>, then tap <CHANNEL LINK>.

The CHANNEL LINK window appears.

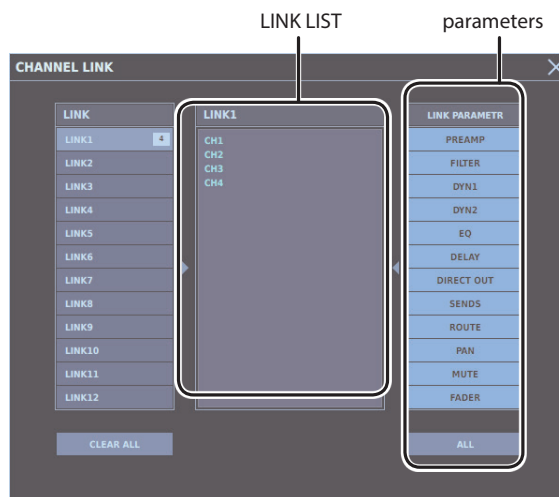

3. Tap a link number from <LINK 1> to <LINK 12>.
4. Tap <LINK LIST>.

A popup for setting the link is displayed.

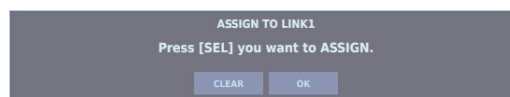

5. Press the [SEL] button for the input channel or output bus you want to assign to the channel link.
The input channel or output bus is assigned to the channel link.
6. Tap <OK>.
7. Select <LINK PARAMETER> to link.

Making Assignments to DCA/MUTE Groups

In DCA groups, you manipulate the levels of all assigned input channels or output buses at one time.

In MUTE groups, you perform batch muting for the assigned input channels or output buses.

1. Access the CH EDIT window.
→ "Access the CH EDIT window" (p. 50)

2. Tap the <DCA/MUTE GROUP tab>.

DCA/MUTE GROUP tab

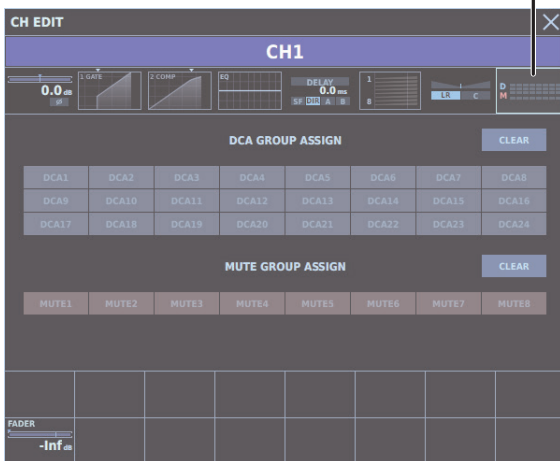

3. Tap an item from <DCA 1> to <DCA 24> or <MUTE 1> to <MUTE 8> to make the assignment to the DCA group or MUTE group.

Using Talkback

1. Go to the talkback section on the top panel and press the [DISP] button.

The TALKBACK/OSC window appears.

2. Tap the <TALKBACK> tab.

The TALKBACK tab appears.

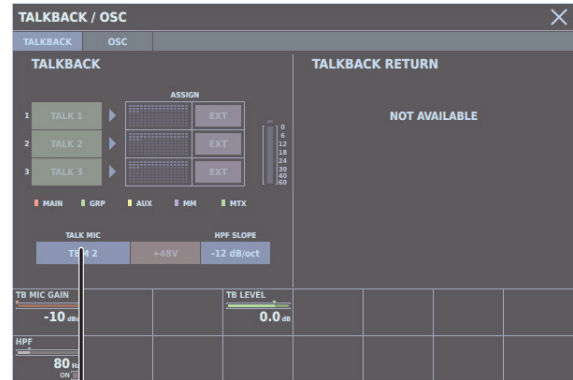

TALK MIC

3. Tap <TALK MIC>.

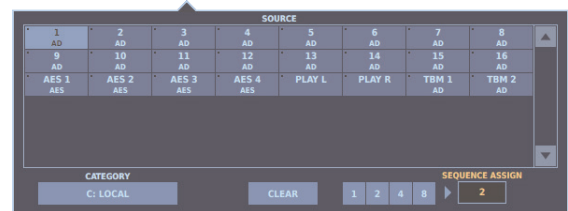

4. Select the input connector.

5. Use the touch display and knob section to make the settings for the talkback mic.

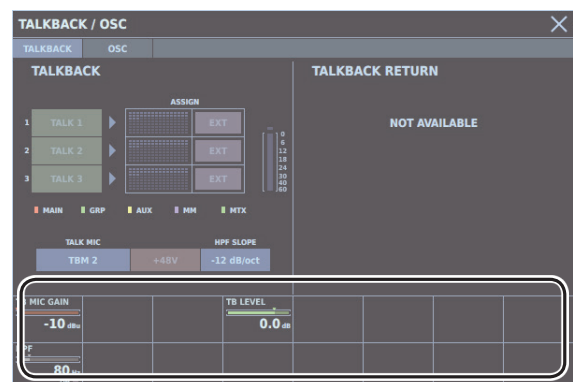

6. Tap <ASSIGN> for TALK 1 to TALK 3.

The DESTINATION popover appears.



- Select the output destination for TALK 1 to TALK 3.
- Press one of the [TALK 1] through [TALK 3] buttons in the talkback section.

Talkback is sent to the selected output bus.

MEMO

The way in which talkback is turned on and off differs depending on how you press the [TALK 1] through [TALK 3] buttons.
 When you release the button quickly after pressing it, it operates as a latch to turn talkback on or off with each press.
 When depressed for a longer interval before release, it operates as a momentary switch that turns on talkback only while held down.

Using the Oscillators

- Go to the talkback section on the top panel and press the [DISP] button.

The TALKBACK/OSC window appears.

- Tap the <OSC tab>.

The TALKBACK/OSC window OSC tab appears.

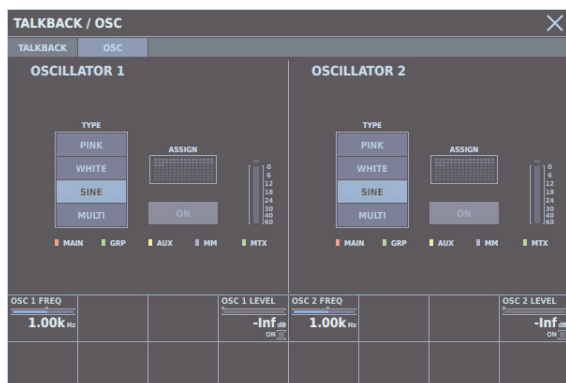

- Select OSCILLATOR TYPE.

PINK	Pink noise
WHITE	White noise
SINE	Sine wave
MULTI	31-band multi-sine wave

- Tap <ASSIGN>.

The DESTINATION popover appears.

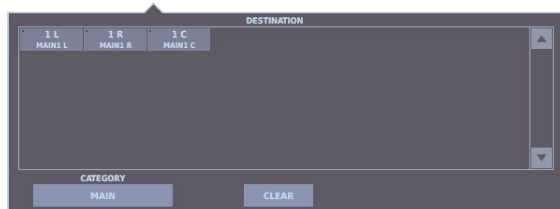

- Select the output destination for the oscillator.
- Tap <ON>.
- Tap <OSC 1 LEVEL>/<OSC 2 LEVEL>.
- Use the selected knob to adjust the level of the oscillator.

The oscillator signal is sent to the selected output bus.

Scene memory

Scene memory is a function that lets you store and recall mixing parameters as "scenes."

Creating New Scenes and Adding Scenes

This adds a new scene following the currently selected scene.

- Go to the scene section on the top panel and press the [NEW] button.



A popup for setting the scene name is displayed.

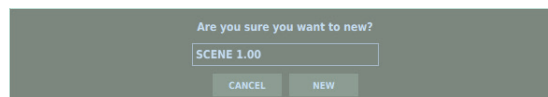

- Specify the scene name, then press the [NEW] button.

A new scene is added immediately following the currently selected scene.

Storing a Scene (by Overwriting)

- Go to the scene section on the top panel and press the [SELECT ▲] or [SELECT ▼] button to select the number of the scene you want to store.

- Press the [STORE] button.

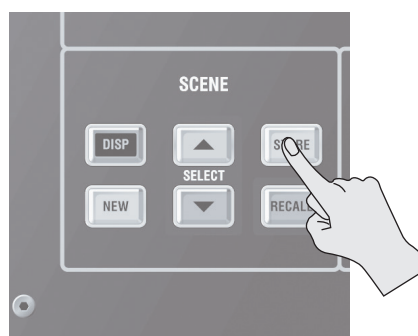

A popup prompting you to confirm the operation is displayed.

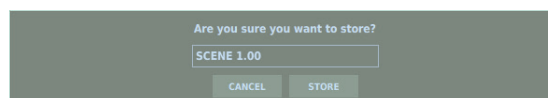

- Press the [STORE] button.

The scene is stored.

Recalling a Scene

1. Go to the scene section on the top panel and press the [SELECT ▲] or [SELECT ▼] button to select the number of the scene you want to recall.
2. Press the [RECALL] button.

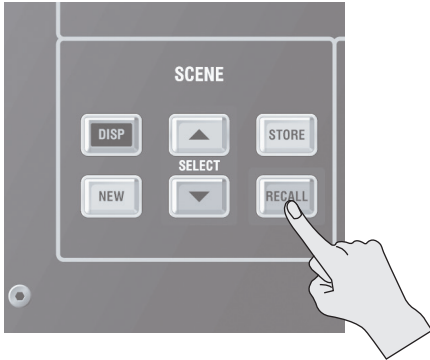

A popup prompting you to confirm the operation is displayed.

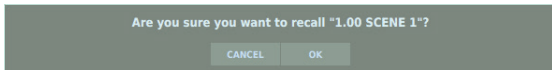

3. Press the [RECALL] button.
The scene is recalled.

Recording/Playback to/from a USB Flash Drive

You can record 2-track WAV files to a USB flash drive. You can also play back 2-track WAV files from a USB flash drive.

WAV File Formats

The formats of recordable WAV files are as follows.

The sampling frequency of recorded WAV files is the same as the M-5000's sampling frequency.

Sampling frequency: 96kHz, 48kHz, 44.1kHz
Bit depth: 16bits
Number of channels: 2 channels

The formats of playable WAV files are as follows.

Playback is possible even if the sampling frequency of the WAV file differs from the M-5000's sampling frequency.

Sampling frequency: 96kHz, 48kHz, 44.1kHz
Bit depth: 24bits, 16bits
Number of channels: 2 channels, 1channel

Recording to a USB Flash Drive

1. Go to the recorder section on the top panel and press the [DISP] button.

The RECORDER window appears.

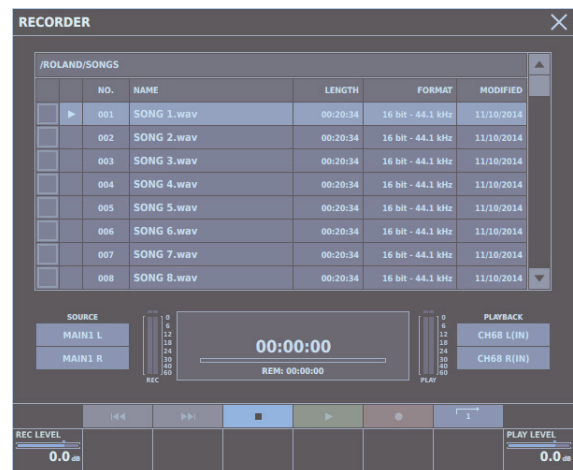

2. Tap <SOURCE>.

The SOURCE popover appears.



3. Select the output bus for recording.
4. Go to the recorder section on the top panel and press the [●] button.
5. Go to the recorder section on the top panel and press the [▶] button.
Recording on the selected output bus starts.
6. Go to the recorder section on the top panel and press the [■] button.
Recording stops.

Playback from a USB Flash Drive

1. Go to the recorder section on the top panel and press the [DISP] button.
The RECORDER window appears.
2. Tap <PLAYBACK>.
The DESTINATION popover appears.

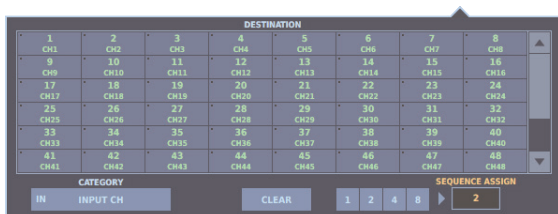

3. Select the input channel to receive the playback output.
4. Go to the recorder section on the top panel and press the [▶] button.
The WAV file is played back.
5. Go to the recorder section on the top panel and press the [■] button.
Playback stops.

Backing Up All Data in the M-5000

The data in the M-5000 is saved as a project file. You back up the data in the M-5000 by saving the project file to a USB flash drive.

Saving a Project File to a USB Flash Drive

1. Press the [MENU] button.
2. On the MENU window, tap <SETUP>, then tap <PROJECT>.
The PROJECT window appears.

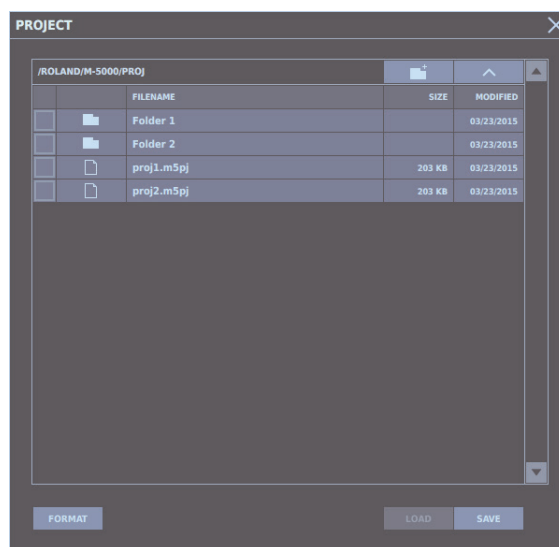

3. Move to the folder where you want to save the file.

	Moves one level below the current folder.
	Creates a new folder at the current level.
	Moves up one level.

4. Tap <SAVE>.
A window for specifying the file name is displayed.

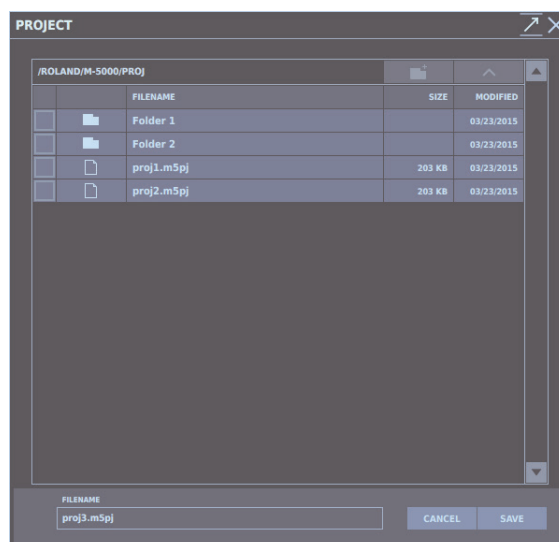

- Specify the file name, then tap <SAVE>. The project file is saved to the USB flash drive.

Restoring All Data in the M-5000

The data in the M-5000 is saved as a project file. You restore data to the M-5000 by loading a project file from a USB flash drive.

Loading a Project File from a USB Flash Drive

- Press the [MENU] button.
- On the MENU window, tap <SETUP>, then tap <PROJECT>.

The PROJECT window appears.

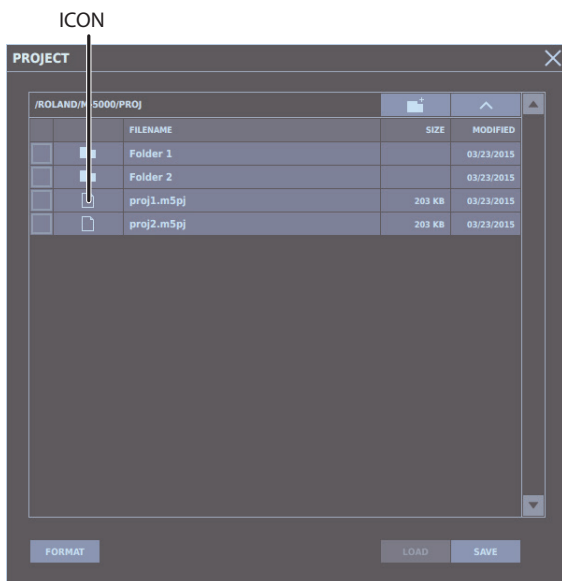

- Move to the folder where you want to load the file.

	Moves one level below the current folder.
	Moves up one level.

- Tap <ICON> for the project file you want to load.
- Tap <LOAD>.

The LOAD PROJECT window appears.

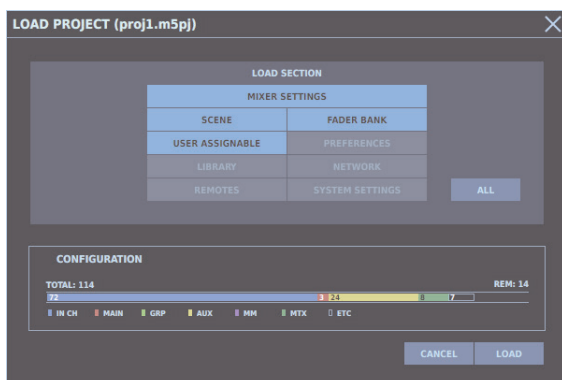

- Select the section you want to load, then tap <LOAD>. The data in the selected section is loaded.

Formatting a USB Flash Drive on the M-5000

- Press the [MENU] button.
- On the MENU window, tap <SETUP>, then tap <PROJECT>.

The PROJECT window appears.

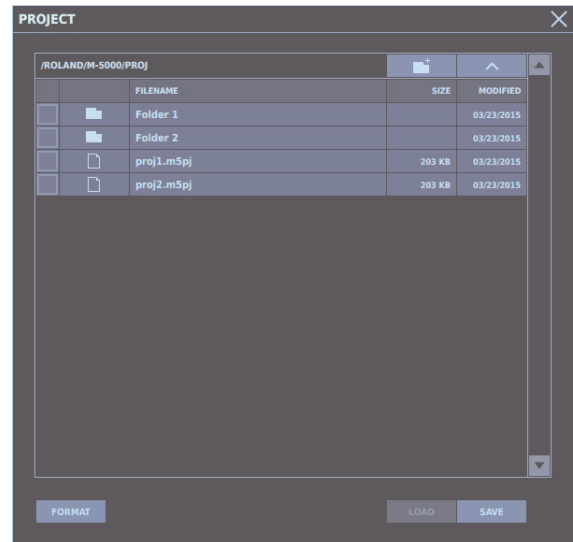

- Tap <FORMAT>. A popup prompting you to confirm the operation is displayed.
- Tap <FORMAT>. Formatting of the USB flash drive starts.

Muting All Outputs

This mutes all outputs at times such as when turning the M-5000's power on or off.

- Press the [MENU] button.
- On the MENU window, tap <MUTE GROUP>. The MUTE GROUP MASTER window appears.



- Turn on <MUTE ALL OUTPUTS>. This mutes all outputs on the M-5000 and input/output units.

Setting the Date and Time

1. On the HOME screen, tap <DATE & TIME AREA>.



The DATE & TIME window appears.

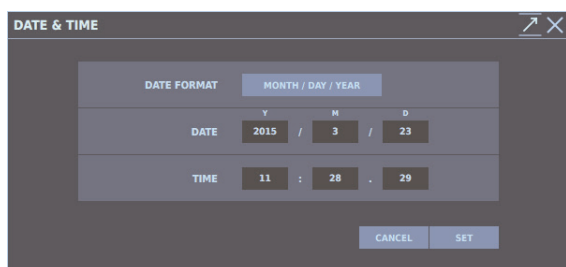

2. Set the date and time, then tap <SET>.

The settings for the date and time are applied.

Factory Reset

This initializes the M-5000, returning it to its factory-default state.

NOTE

Performing initialization causes all data to be lost.
Data that is needed can be saved to a USB flash drive.
→ "Backing Up All Data in the M-5000" (p. 61)
→ "Restoring All Data in the M-5000" (p. 62)

1. Go to the Display section on the top panel, and while holding down the [MENU] button and [VIEW] button, turn on the power to the M-5000.
2. Tap <FACTORY INITIALIZE>.
A popup prompting you to confirm the initialization operation is displayed.
3. Tap <INITIALIZE>.
Initialization starts.

NOTE

Never turn off the power to the M-5000 before initialization finishes.
The factory reset will require approximately 10 minutes.
4. When "Factory Initialize completed." appears, tap <OK>.
5. Turn off the power.

Fader Calibration

If the fader positions are no longer aligned with the index markings of the top panel, carry out fader calibration to adjust.

1. Press the [MENU] button.
2. On the MENU window, tap <SYSTEM>, then tap <FADER CALIBRATION>.

The FADER CALIBRATION window appears.

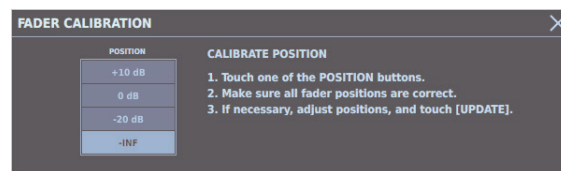

3. Tap an item from <-INF> to <+10dB>.

This moves to the location where all faders are supported.

4. Adjust the fader that is not aligned with the index markings on the top panel.

The <UPDATE> appears.



5. Tap <UPDATE>.

The fader position is adjusted to the specified location.

Main specifications

Roland M-5000/M-5000C: LIVE MIXING CONSOLE

Processing

Mixing Structure

Up to 128 Audio Paths (combination of INPUT CHANNEL, MAIN, SUBGROUP, AUX, MIX-MINUS, MATRIX, MONITOR, COMM, OSC, HEADPHONES)

Inputs

Max 300 (96 kHz), Max 460 (48 kHz / 44.1 kHz)

- CONSOLE: 16
- AES/EBU: 4
- REAC: 40 x 2
- EXPANSION SLOT: 80 x 2 (96 kHz), 160 x 2 (48 kHz / 44.1 kHz)
- USB AUDIO: 16
- DOCK: 2
- USB RECORDER: 2
- FX 1L-8R: 16
- TALKBACK: 2
- OSC: 2

Outputs

M-5000: Max 296 (96 kHz), Max 456 (48 kHz / 44.1 kHz)
M-5000C: Max 288 (96 kHz), Max 448 (48 kHz / 44.1 kHz)

- CONSOLE (M-5000): 16
- CONSOLE (M-5000C): 8
- AES/EBU: 4
- REAC: 40 x 2
- EXPANSION SLOT: 80 x 2 (96 kHz), 160 x 2 (48 kHz / 44.1 kHz)
- USB AUDIO: 16
- DOCK: 2
- USB RECORDER: 2
- FX 1L-8R: 16

Internal Processing

- 72 bits (fixed point, bus summing)

Signal Processing

- AD/DA Conversion: 24 bit
- Sampling Rate: 96 kHz, 48 kHz, or 44.1 kHz

Latency

- Network Latency: 1.6 ms (typ.)
- Console Latency: 1.1 ms (typ.)
- * Network Latency: Total system latency of audio signal from S-2416 inputs to outputs via M-5000's REAC ports (A or B).
- * Console Latency: Total system latency of audio signal from console inputs to console outputs.
- * Sampling rate: 96 kHz
- * Effect: No insert effects
- * When a REAC Splitter S-4000D or a switching hub is used in-line with REAC cables, the network latency will increase by the amount of processing delay introduced by the splitting device itself. The actual delay is dependant upon the specifications of the splitting device, though the maximum delay amount for a single splitting device should be about 200 microseconds.

Connectors

- INPUT jacks (1–16): XLR-3-31 type (balanced, phantom power)
- TALKBACK MIC 2 jack: XLR-3-31 type (balanced, phantom power)
- AES/EBU IN jacks (1/2, 3/4): XLR-3-31 type (balanced)
- OUTPUT jacks (M-5000: 1–16, M-5000C: 1-8): XLR-3-32 type (balanced)
- PHONES 1 jack: Stereo 1/4 inch phone type
- PHONES 2 jack: Stereo miniature phone type
- AES/EBU OUT jacks (1/2, 3/4): XLR-3-32 type
- REAC ports (A, B, SPLIT/BACKUP): RJ-45 EtherCon type, REAC SPLIT/BACKUP port supports REAC EMBEDDED POWER.
- WORD CLOCK connector (IN, OUT): BNC type
- RS-232C connector: DB-9 type
- MIDI connector (OUT/THRU, IN)
- USB port (MEMORY): USB type A
- USB WLAN ADAPTOR port: USB type A
- USB COMPUTER port: USB type B
- LAN port: RJ45 type
- DOCK CABLE port: 10-pin mini DIN type
- GP I/O port: DB-25 type
- FOOT SWITCH jacks (1, 2): 1/4-inch TRS phone type
- LAMP jacks: XLR-4-31 type (M-5000: x 2, M-5000C: x1), LAMP power: DC +12 V/500 mA
- EXT.POWER DC IN jack: XLR-4-32 type
- * XLR type: 1 GND, 2 HOT, 3 COLD
- * Phantom power: DC +48 V (unloaded maximum), 14 mA (maximum load) (All XLR type inputs)

Input/Output Characteristics

Input Impedance

- INPUT jacks (1–16): 7 k ohms
- TALKBACK MIC 2 jack: 4 k ohms (Phantom: ON)

Nominal Input Level (Variable, typ.)

- INPUT jacks (1–16): -65 to -10 dBu (Pad: OFF), -45 to +10 dBu (Pad: ON)
- TALKBACK MIC 2 jack: -65 to -10 dBu

Non Clip Maximum Input level (1 kHz, typ.)

- INPUT jacks (1–16): +8 dBu (Pad: OFF), +28 dBu (Pad: ON)
- TALKBACK MIC 2 jack: +8 dBu

Output Impedance (typ.)

- OUTPUT jacks (M-5000: 1–16, M-5000C: 1-8): 600 ohms
- PHONES jacks (1, 2): 45 ohms

Recommended Load Impedance

- OUTPUT jacks (M-5000: 1–16, M-5000C: 1-8): 10 k ohms or greater
- PHONES jacks (1, 2): 32 ohms or greater

Minimum Load Impedance

- PHONES jacks (1, 2): 16 ohms

Nominal Output Level (ty.)

- OUTPUT jacks (M-5000: 1–16, M-5000C: 1-8): +4 dBu (Load impedance: 10 k ohms)

Non Clip Maximum Output level (1 kHz, typ.)

- OUTPUT jacks (M-5000: 1–16, M-5000C: 1-8): +22 dBu (10 k ohms load)
- PHONES jacks (1, 2): 500 mW + 500 mW (40 ohms load)

Other

Display

- Graphic color LCD 800 x 600 dots (touch screen)
- Graphic organic light emitting display 256 x 64 dots (M-5000: Fader Bank Display x 7, M-5000C: Fader Bank Display x 5, User Assignable Display x 1)

Power Consumption

- 180 W

Dimensions (M-5000)

- 934 (W) x 725 (D) x 346 (H) mm
- 36-13/16 (W) x 28-9/16 (D) x 13-5/8 (H) inches

Dimensions (M-5000C)

- 740 (W) x 725 (D) x 346 (H) mm
- 29-3/16 (W) x 28-9/16 (D) x 13-5/8 (H) inches

Weight (M-5000)

- 36 kg
- 79 lbs 6 oz

Weight (M-5000C)

- 32 kg
- 70 lbs 9 oz

Operation Temperature

- +5 to +40 degrees Celsius
- +41 to +104 degrees Fahrenheit

Accessories

- Owner's manual
- Power cord
- Dock cable
- REAC connector cover x 3
- Ferrite core x 6
- Tablet sheet (M-5000: x2, M-5000C: x1)
- Cover

* 0 dBu = 0.775 Vrms

* In the interest of product improvement, the specifications and/or appearance of this unit are subject to change without prior notice.

Dimensions

M-5000

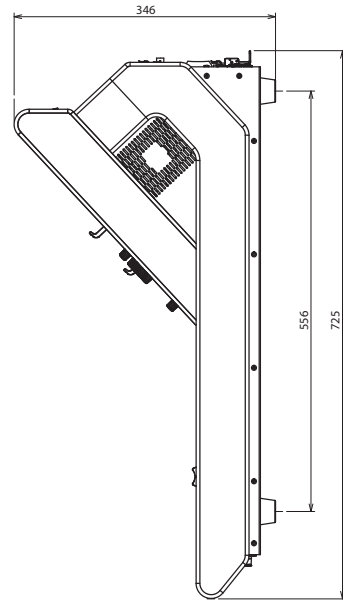
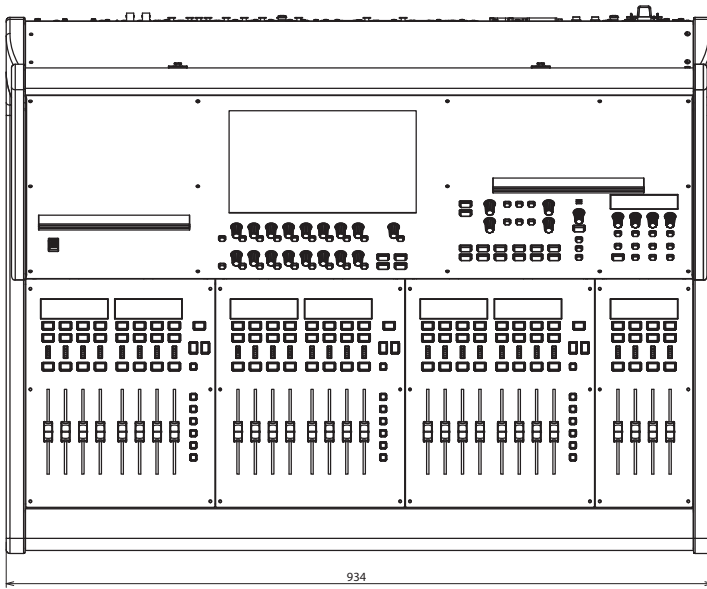
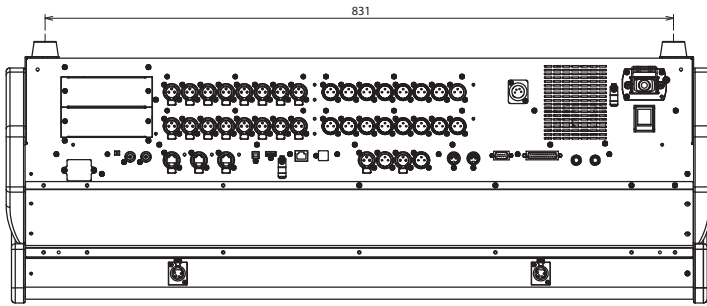

* Dimensions are shown in millimeters.

M-5000C

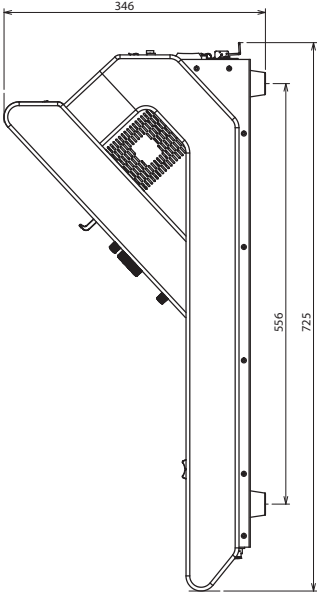
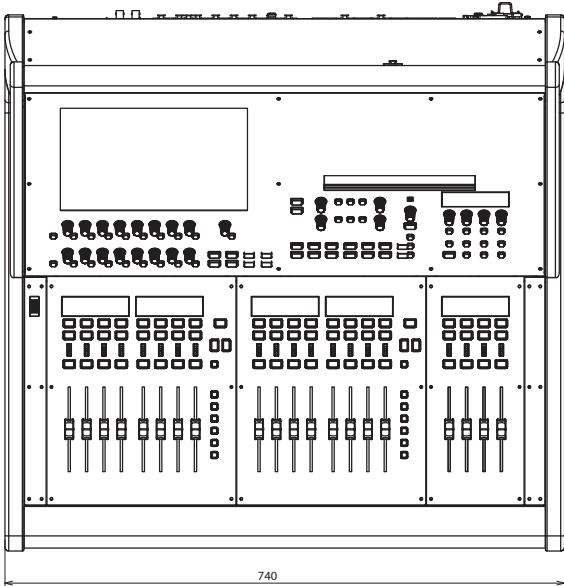
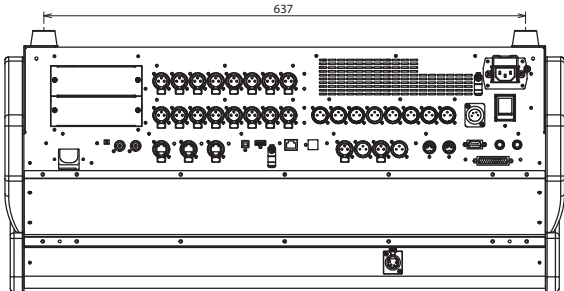

* Dimensions are shown in millimeters.

Memo



This product is intended for use in the following Electromagnetic environments:
E1: residential, E2: commercial and light industrial, E3: urban outdoors,
ex. recording studio which are specified in EN55103-1 and EN55103-2.

For EU Countries

Apparatus containing Lithium batteries

ADVARSEL!

Lithiumbatteri - Eksplosionsfare ved fejlagtig håndtering.
Udskiftning må kun ske med batteri af samme fabrikat og type.
Levér det brugte batteri tilbage til leverandøren.

ADVARSEL

Eksplosjonsfare ved feilaktig skifte av batteri.
Benytt samme batteritype eller en tilsvarende type anbefalt av apparatfabrikanten.
Brukte batterier kasseres i henhold til fabrikantens instruksjoner.

CAUTION

Danger of explosion if battery is incorrectly replaced.
Replace only with the same or equivalent type recommended by the manufacturer.
Discard used batteries according to the manufacturer's instructions.

VARNING

Explosionsfara vid felaktigt batteribyte.
Använd samma batterityp eller en ekvivalent typ som rekommenderas av apparattillverkaren.
Kassera använt batteri enligt fabrikantens instruktion.

VAROITUS

Paristo voi räjähtää, jos se on virheellisesti asennettu.
Vaihda paristo ainoastaan laitevalmistajan suosittelemaan tyyppiin. Hävitä käytetty paristo valmistajan ohjeiden mukaisesti.

For the USA

FEDERAL COMMUNICATIONS COMMISSION RADIO FREQUENCY INTERFERENCE STATEMENT

This equipment has been tested and found to comply with the limits for a Class B digital device, pursuant to Part 15 of the FCC Rules. These limits are designed to provide reasonable protection against harmful interference in a residential installation. This equipment generates, uses, and can radiate radio frequency energy and, if not installed and used in accordance with the instructions, may cause harmful interference to radio communications. However, there is no guarantee that interference will not occur in a particular installation. If this equipment does cause harmful interference to radio or television reception, which can be determined by turning the equipment off and on, the user is encouraged to try to correct the interference by one or more of the following measures:

- Reorient or relocate the receiving antenna.
- Increase the separation between the equipment and receiver.
- Connect the equipment into an outlet on a circuit different from that to which the receiver is connected.
- Consult the dealer or an experienced radio/TV technician for help.

This device complies with Part 15 of the FCC Rules. Operation is subject to the following two conditions:

- (1) this device may not cause harmful interference, and
- (2) this device must accept any interference received, including interference that may cause undesired operation.

This equipment requires shielded interface cables in order to meet FCC class B limit.

Any unauthorized changes or modifications not expressly approved by the party responsible for compliance could void the user's authority to operate the equipment.

For Canada

CAN ICES-3 (B)/NMB-3 (B)

For Korea

사용자 안내문

기종별	사용자 안내문
B 급 기기 (가정용 방송통신기자재)	이 기기는 가정용(B 급) 전자파적합기기로서 주로 가정에서 사용하는 것을 목적으로 하며, 모든 지역에서 사용할 수 있습니다.

For C.A. US (Proposition 65)

WARNING

This product contains chemicals known to cause cancer, birth defects and other reproductive harm, including lead.



DECLARATION OF CONFORMITY Compliance Information Statement

Model Name : M-5000/M-5000C
 Type of Equipment : Digital Audio Mixer
 Responsible Party : Roland Corporation U.S.
 Address : 5100S. Eastern Avenue Los Angeles, CA 90040-2938
 Telephone : (323) 890-3700

For EU Countries



- UK** This symbol indicates that in EU countries, this product must be collected separately from household waste, as defined in each region. Products bearing this symbol must not be discarded together with household waste.
- DE** Dieses Symbol bedeutet, dass dieses Produkt in EU-Ländern getrennt vom Hausmüll gesammelt werden muss gemäß den regionalen Bestimmungen. Mit diesem Symbol gekennzeichnete Produkte dürfen nicht zusammen mit dem Hausmüll entsorgt werden.
- FR** Ce symbole indique que dans les pays de l'Union européenne, ce produit doit être collecté séparément des ordures ménagères selon les directives en vigueur dans chacun de ces pays. Les produits portant ce symbole ne doivent pas être mis au rebut avec les ordures ménagères.
- IT** Questo simbolo indica che nei paesi della Comunità europea questo prodotto deve essere smaltito separatamente dai normali rifiuti domestici, secondo la legislazione in vigore in ciascun paese. I prodotti che riportano questo simbolo non devono essere smaltiti insieme ai rifiuti domestici. Ai sensi dell'art. 13 del D.Lgs. 25 luglio 2005 n. 151.
- ES** Este símbolo indica que en los países de la Unión Europea este producto debe recogerse aparte de los residuos domésticos, tal como este regulado en cada zona. Los productos con este símbolo no se deben depositar con los residuos domésticos.
- PT** Este símbolo indica que nos países da UE, a recolha deste produto deverá ser feita separadamente do lixo doméstico, de acordo com os regulamentos de cada região. Os produtos que apresentem este símbolo não deverão ser eliminados juntamente com o lixo doméstico.
- NL** Dit symbool geeft aan dat in landen van de EU dit product gescheiden van huishoudelijk afval moet worden aangeboden, zoals bepaald per gemeente of regio. Producten die van dit symbool zijn voorzien, mogen niet samen met huishoudelijk afval worden verwijderd.
- DK** Dette symbol angiver, at i EU-lande skal dette produkt opsamles adskilt fra husholdningsaffald, som defineret i hver enkelt region. Produkter med dette symbol må ikke smides ud sammen med husholdningsaffald.
- NO** Dette symbolet indikerer at produktet må behandles som spesialavfall i EU-land, iht. til retningslinjer for den enkelte regionen, og ikke kastes sammen med vanlig husholdningsavfall. Produkter som er merket med dette symbolet, må ikke kastes sammen med vanlig husholdningsavfall.

- SE** Symbolen anger att i EU-länder måste den här produkten kasseras separat från hushållsavfall, i enlighet med varje regions bestämmelser. Produkter med den här symbolen får inte kasseras tillsammans med hushållsavfall.
- FI** Tämä merkintä ilmaisee, että tuote on EU-maissa kerättävä erillään kotitalousjätteistä kunkin alueen voimassa olevien määräysten mukaisesti. Tällä merkinnällä varustettuja tuotteita ei saa hävittää kotitalousjätteiden mukana.
- HU** Ez a szimbólum azt jelenti, hogy az Európai Unióban ezt a terméket a háztartási hulladéktól elkülönítve, az adott régióban érvényes szabályozás szerint kell gyűjteni. Az ezzel a szimbólummal ellátott termékeket nem szabad a háztartási hulladék közé dobni.
- PL** Symbol oznacza, że zgodnie z regulacjami w odpowiednim regionie, w krajach UE produktu nie należy wyrzucać z odpadami domowymi. Produktów opatrzonych tym symbolem nie można utylizować razem z odpadami domowymi.
- CZ** Tento symbol udává, že v zemích EU musí být tento výrobek sbírán odděleně od domácího odpadu, jak je určeno pro každý region. Výrobky nesoucí tento symbol se nesmí vyhazovat spolu s domácím odpadem.
- SK** Tento symbol vyjadruje, že v krajinách EÚ sa musí zber tohto produktu vykonávať oddelene od domového odpadu, podľa nariadení platných v konkrétnej krajine. Produkty s týmto symbolom sa nesmú vyhazovať spolu s domovým odpadom.
- EE** See sümbol näitab, et EL-i maades tuleb see toode olemprügist eraldi koguda, nii nagu on igas piirkonnas määratletud. Selle sümboliga märgitud tooteid ei tohi ära visata koos olmeprügiga.
- LT** Šis simbolis rodo, kad ES šalyse šis produktas turi būti surenkamas atskirai nuo buitinių atliekų, kaip nustatyta kiekviename regione. Šiuo simboliu paženklinėti produktai neturi būti išmetami kartu su buitiniams atliekoms.
- LV** Šis simbols norāda, ka ES valstīs šo produktu jāievāc atsevišķi no mājsaimniecības atkritumiem, kā noteikts katrā reģionā. Produkta ar šo simbolu nedrīkst izmest kopā ar mājsaimniecības atkritumiem.
- SI** Ta simbol označuje, da je treba proizvod v državah EU zbirati ločeno od gospodinskih odpadkov, tako kot je določeno v vsaki regiji. Proizvoda s tem znakom ni dovoljeno odlagati skupaj z gospodinskimi odpadki.
- GR** Το σύμβολο αυτό υποδηλώνει ότι στις χώρες της Ε.Ε. το συγκεκριμένο προϊόν πρέπει να συλλέγεται χωριστά από τα υπόλοιπα οικιακά απορρίμματα, σύμφωνα με όσα προβλέπονται σε κάθε περιοχή. Τα προϊόντα που φέρουν το συγκεκριμένο σύμβολο δεν πρέπει να απορρίπτονται μαζί με τα οικιακά απορρίμματα.

For China

有关产品中所含有害物质的说明

本资料就本公司产品中所含的特定有害物质及其安全性予以说明。

本资料适用于 2007 年 3 月 1 日以后本公司所制造的产品。

环保使用期限



此标志适用于在中国国内销售的电子信息产品，表示环保使用期限的年数。所谓环保使用期限是指在自制造日起的规定期限内，产品中所含的有害物质不致引起环境污染，不会对人身、财产造成严重的不良影响。环保使用期限仅在遵照产品使用说明书，正确使用产品的条件下才有效。不当的使用，将会导致有害物质泄漏的危险。

产品中有毒有害物质或元素的名称及含量

部件名称	有毒有害物质或元素					
	铅(Pb)	汞(Hg)	镉(Cd)	六价铬(Cr(VI))	多溴联苯(PBB)	多溴二苯醚(PBDE)
外壳(壳体)	×	○	○	○	○	○
电子部件(印刷电路板等)	×	○	×	○	○	○
附件(电源线、交流适配器等)	×	○	○	○	○	○

○：表示该有毒有害物质在该部件所有均质材料中的含量均在 SJ/T11363-2006 标准规定的限量要求以下。

×：表示该有毒有害物质至少在该部件的某一均质材料中的含量超出 SJ/T11363-2006 标准规定的限量要求。

因根据现有的技术水平，还没有什么物质能够代替它。



About Support and Service

You can get product information and answers to frequently asked questions and download various reference materials from the Roland website. You can download, at no charge, the M-5000 RCS dedicated control software that runs on Macintosh and Windows-based computers.



* 5 1 0 0 0 4 7 9 5 4 - 0 1 *