

StudioLive™ Series III

Stagebox Mode Addendum



Table of Contents

1 Overview — 1

1.1 About AVB Networking — 1

2 Getting Started — 2

2.1 Channel Routing Grid — 5

2.2 Preamp Control — 6

2.3 Stagebox Modes — 6

2.4 Recording in Stagebox Mode — 8

1 Overview

There are two types of potential data flowing to and from your StudioLive Series III mixer: control and audio. Control connections can be made over standard Ethernet networks, including WiFi networks. Sending and receiving audio requires an AVB network. Unlike control, AVB audio cannot be sent wirelessly.

- **Control:** This is the primary communication between your StudioLive Series III rackmount mixer and your computer, iPad, or Android device. When networked to your StudioLive, any device running UC Surface controls the mixers' functions.
- **Audio:** An AVB network connection enables routing audio to and from the StudioLive Series III rackmount mixer's audio inputs and outputs with a StudioLive Series III console mixer in stagebox mode; to a Mac for playback and recording; or to any 1722.1 AVB device.

***Power User Tip:** Network connections occasionally require troubleshooting, especially when a lot of wireless networks are in use. Because of this, it is always a good idea to get your networked devices happily communicating before the pressure is on and you have a singer trying to dial in a monitor mix while you're trying to mic the drum kit.*

1.1 About AVB Networking

AVB (Audio Video Bridging) is an extension to the Ethernet standard designed to provide "guaranteed quality of service," which simply means that audio samples will reach their destinations on time. AVB has been adopted by numerous audio companies, and more companies are adding it all the time. AVB networking offers a number of features that make it ideal for audio applications:

- **Long, light cable runs.** A single lightweight CAT5e or CAT6 cable can be run up to 100 meters (300 feet). This makes it easy to have audio I/O located in different rooms (or even different venues in the same building) and run multichannel audio between them in real time.
- **Low, predictable latency.** The AVB specification states latency of no longer than 2 ms sending an audio stream point-to-point over up to seven "hops" (trips through switches or other devices) at 1x (less than or equal to 48 kHz) sample rates.
- **Scalable, with high channel counts.** AVB's bandwidth is sufficient to carry hundreds of real-time channels using a single Ethernet cable. This offers the future possibility of expanding your system with additional devices that contain different kinds of audio I/O, multiple controllers, and other useful functions.
- **Integrated clock signal.** In a digital audio system with multiple devices, having a master clock is absolutely critical. The AVB specification defines such a clock to be accurately distributed to all devices in the system.

***Power User Tip:** The most important rule to keep in mind when setting up an AVB network is that the talker (device sending audio) and listener (device receiving audio) must be connected to an AVB-compatible switch.*

2 Getting Started

StudioLive Series III rackmount mixers can be used as digital stageboxes for any StudioLive Series III console mixer. This guide will get you up and running.

Important: Both StudioLive Series III mixers must be updated with the latest firmware before configuring stagebox mode. Firmware updates and instructions are available from within your My PreSonus user account. Please verify that the latest firmware is loaded on both mixers before proceeding.

What you will need:

- StudioLive Series III console (StudioLive 32, StudioLive 24, StudioLive 16) with the latest firmware update
- StudioLive Series III rackmount mixer (StudioLive 32R, StudioLive 24R, StudioLive 16R) with the latest firmware update
- Ethernet cable
- AVB switch (optional)

Direct connection

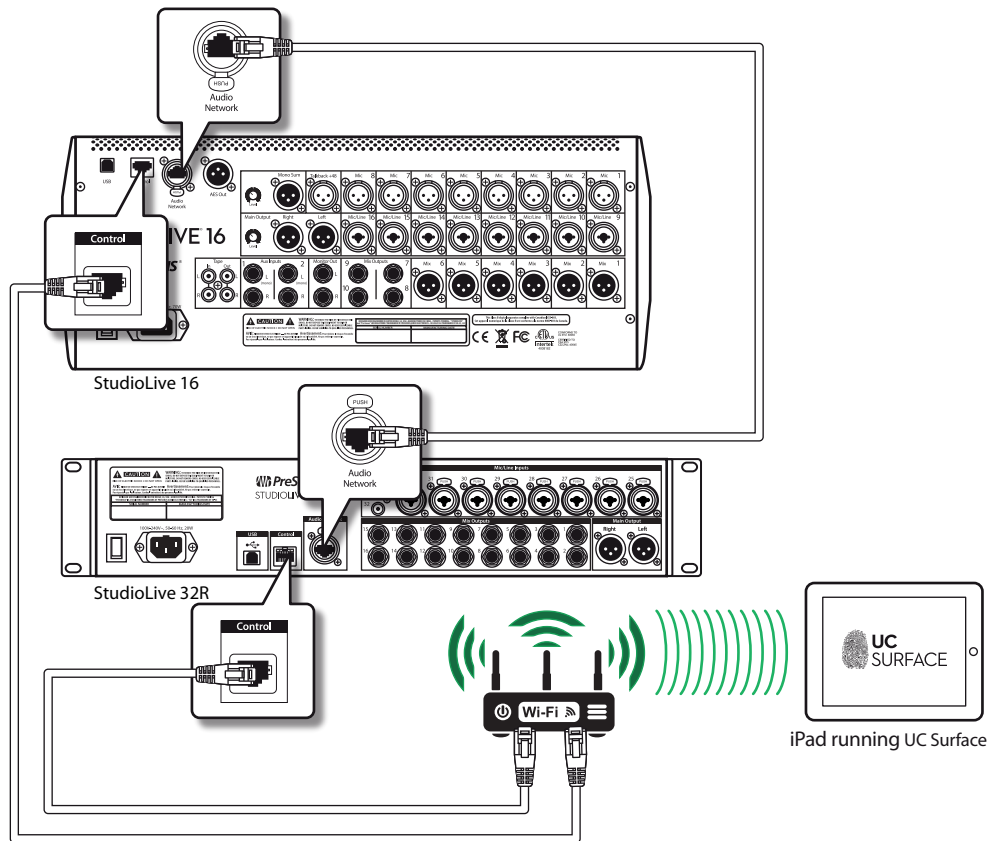

Connect using an AVB switch

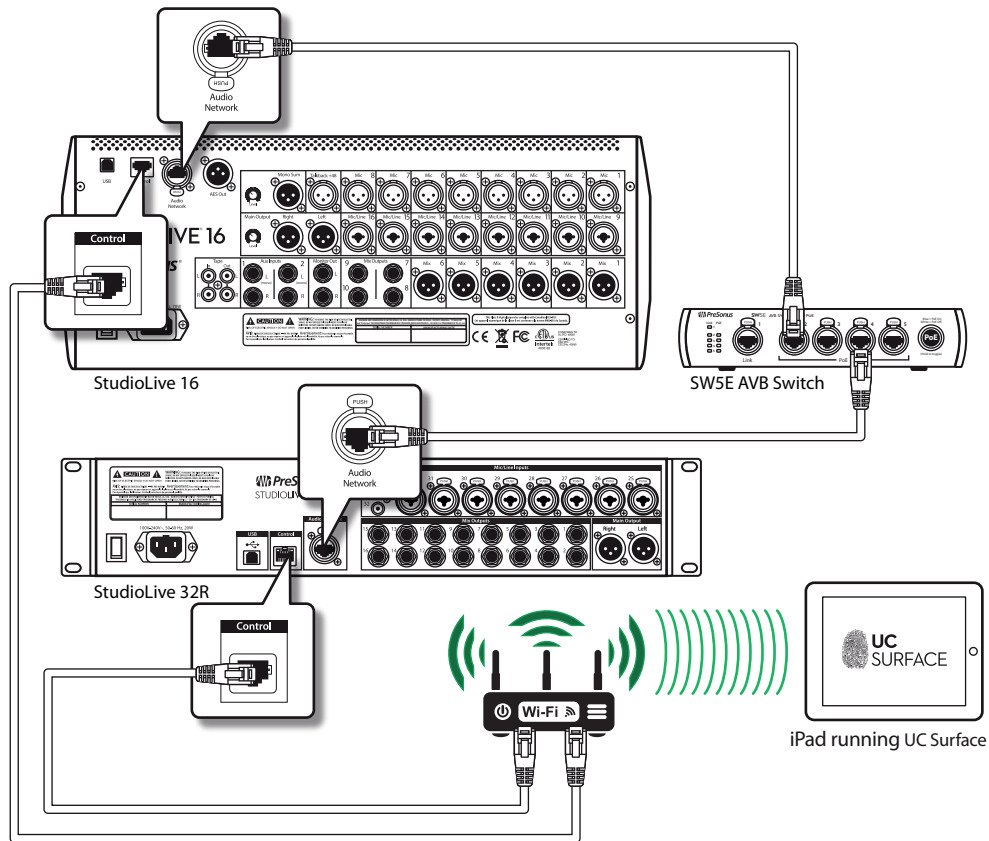

After you have made all the physical connections, you'll need to make the digital network connections.

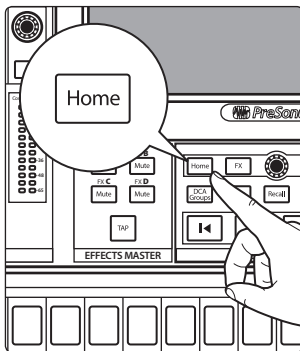

1. Press the Home button on your StudioLive Series III console.

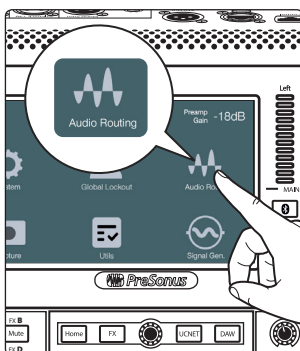

2. Press Audio Routing on the Home Screen.

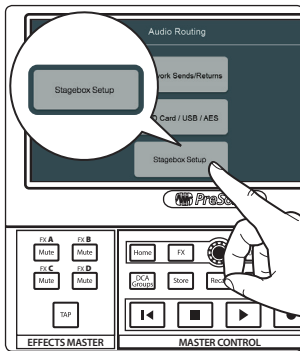

3. Press the Stagebox Setup button on the screen.

4. Tap on the "Select Rack Mixer" menu and choose your rack mixer from the list.

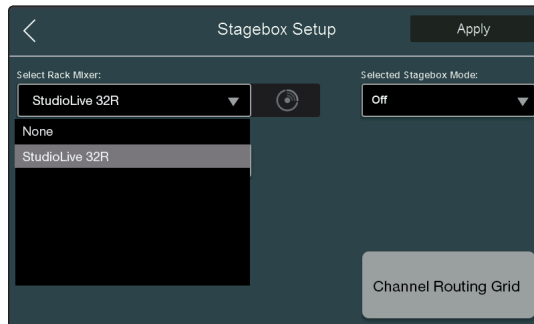

If you have more than one rack mixer connected on the network and are unsure which mixer is which, you can press the Identify button. This will flash the front panel LEDs on whichever mixer is currently selected in the dropdown menu.

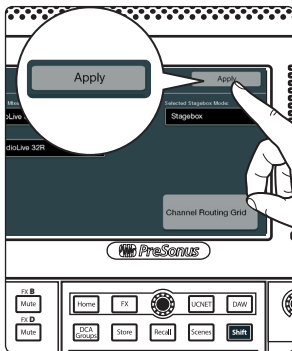

5. Tap Apply to connect to your mixer.

6. Once your rack mixer is successfully connected, you will see it in "Connected" field on the screen.

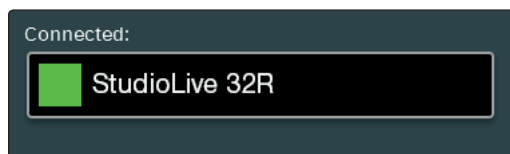

7. Select the Stagebox Mode you would like to use. See **Section 2.3** for information on the different modes.

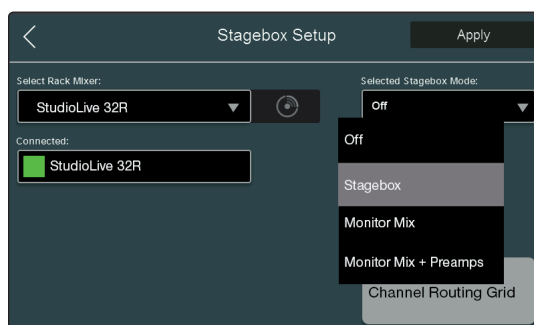

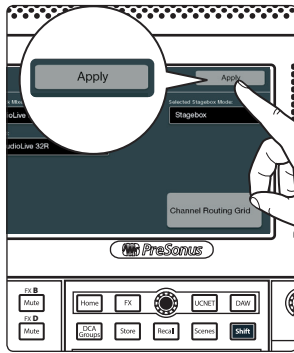

8. Tap Apply to save the mode.

Power User Tip: Connecting to your mixer and selecting the mode can be one or two steps. When Apply is pressed, both the selected mixer and the selected Stagebox Mode are saved simultaneously.

2.1 Channel Routing Grid



StudioLive Series III mixers route channels in banks of 8. From the Channel Routing page, you can change the default routing:

Inputs	1-8	9-15	16-24	25-32
1-8				
9-15				
16-24				
25-32				

Note: Once channels have been patched between your StudioLive Series III rackmount mixer to your StudioLive Series III console mixer, they can be accessed by selecting the Network input as the source on either mixer. For example, if you would like Channel 1 on your console mixer to be sourced from Channel 1 on your rack mixer, you must select Network as the input source on your console mixer. In this way, you can access local analog, network, USB, or SD input sources for each channel as needed.

Select Network on Console

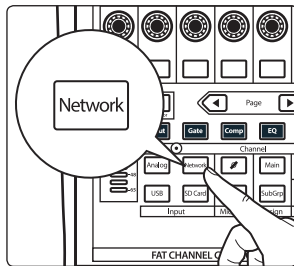

If you would like the input source for any channel on your StudioLive Series III console mixer to come from your StudioLive Series III rack mixer, select that channel on your console mixer and enable Network as the Input Source. For example, if you would like to use the guitar connected to Input 3 on your StudioLive 16R in any mix on your StudioLive 24, you would select Channel 3 on your StudioLive 24 and enable Network as the input source.

Select Network in UC Surface

If you would like the input source for any channel on your StudioLive Series III rack mixer to come from your StudioLive Series III console mixer, select that channel on your rack mixer in UC Surface and enable Network as the Input Source. For example, if you would like to use the microphone connected to Input 30 on your StudioLive 32 in any mix on your StudioLive 32R, you would select Channel 30 in UC Surface for your StudioLive 32R and enable Network as the input source.

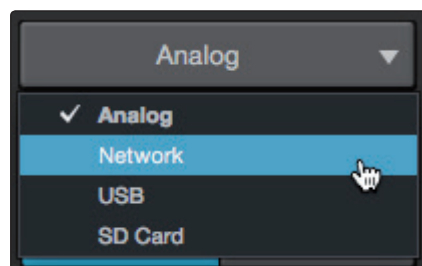

2.2 Preamp Control

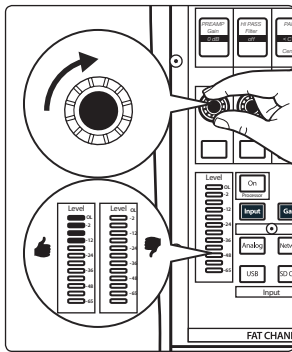

Once the Network input has been selected on the StudioLive Series III console mixer, you can remote control the preamp level and phantom power for your rackmount mixer from the top panel of your console mixer.

Note: When “Off” is selected for Stagebox mode, preamp and phantom power control will not be active.

2.3 Stagebox Modes

StudioLive Series III rack mixers have three different modes of operation when connected as a stagebox to a StudioLive Series III console mixer.

Whichever mode is selected, preset and scene store and recall is independent on each mixer. In other words, saving a scene or a preset on the console mixer will not save the settings on the rack mixer and vice versa.

Stagebox

This is a more traditional Stagebox function, where the StudioLive Series III rackmount mixer simply serves as a remote I/O box for the StudioLive Series III console at FOH. All mixing, both FOH and Aux mixing, is done on the StudioLive Series III console at FOH.

When this mode is active, the mixer DSP on the StudioLive Series III rackmount mixer is bypassed and all StudioLive Series III rackmount Main Left/Right outputs are sourced from the console mixer’s Main Left / Right signals. The StudioLive Series III console mixer’s FlexMixes are sourced from the rack mixer as described below:

	StudioLive 16R	StudioLive 24R	StudioLive 32R
StudioLive 16, StudioLive 24, StudioLive 32	FlexMix 1-6	FlexMix 1-12	FlexMix 1-16

It should be noted that even though the StudioLive 16 console mixer only has 10 outputs, it still has a full 16 Flex Mixes. Using a StudioLive Series III rackmixer of a larger frame size will provide physical outputs for those mixes.

When Network is select as the Input Source for any channel on the console mixer, you can remotely control the preamp gain and phantom power for the respective channel on the rack mixer.

Monitor Mix

While this mode is active, the StudioLive Series III rackmount mixer retains all its mixing functionality for every FlexMix, allowing you to create monitor mixes and more using the FlexMix outputs. The Main Mix in this mode will not be accessible or have any effect on the sound as this mix is sourced from the Main Left/Right mix of the console mixer and must be controlled from there.

Power User Tip: *The FlexMix outputs on your console mixer will remain active as well, allowing you to use both sets of FlexMix outputs and, in effect, doubling your mixing capability.*

When Monitor Mix mode is active, preamp gain and phantom power control cannot be controlled locally on the rack mixer. Your rack mixer preamps will be controlled remotely via the Input section on the Fat Channel of the console mixer when Network is selected as the Input Source.

Monitor Mix + Preamps

This mode functions the same as Monitor Mix mode, but adds remote preamp control for either mixer from the rack mixer in addition to the console mixer. In other words, when Network is selected as the Input Source for any channel on either mixer, you can remotely control the preamp gain and phantom power.

Off

When "Off" is selected, the console and rack mixers will retain their AVB input connectivity (i.e. all the inputs from the rack mixer will be available on the console mixer and vice versa), but each mixer will source its Main Left/Right and FlexMixes locally and preamp control will not be available for the rack mixer from the top panel of the console mixer.

2.4 Recording in Stagebox Mode

When any Stagebox Mode is active, recording is only supported from the console mixer (USB or SD). Because of this, you will want to configure the channels on your StudioLive Series III console mixer for your recording.

The illustration below, shows channels being sourced locally and over the network. Channels 1-12 and 19-24 are sourced from the rack mixer. Channels 13-16 are sourced from the local analog inputs on the console mixer:

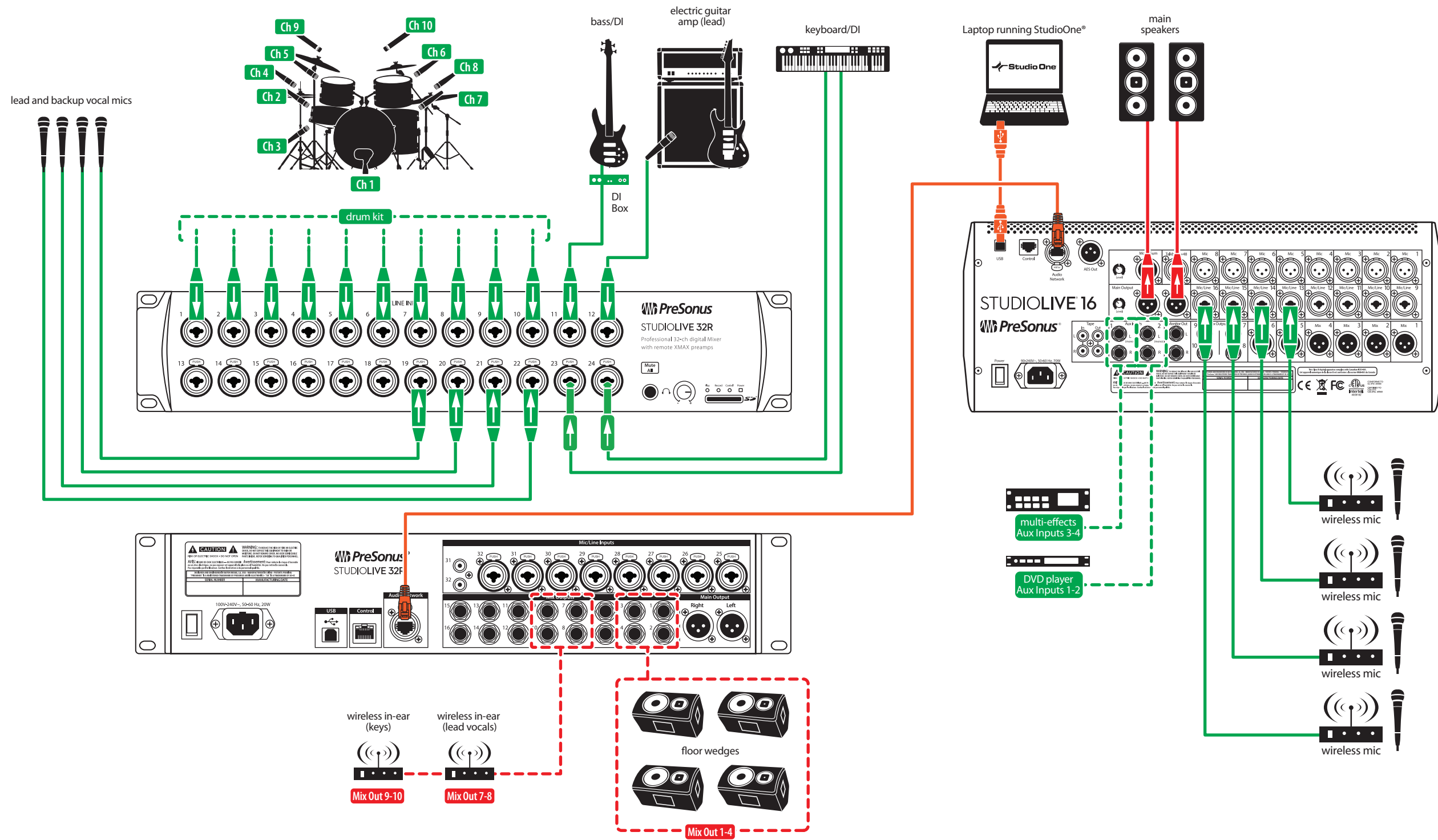

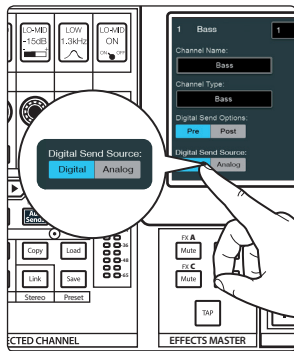

For every channel that you want to source from the Network and record from the console mixer (either USB or SD), you need to set the Digital Send Source to “Digital”. To do this, navigate to the channel settings on the console mixer and enable the Digital Send Source.

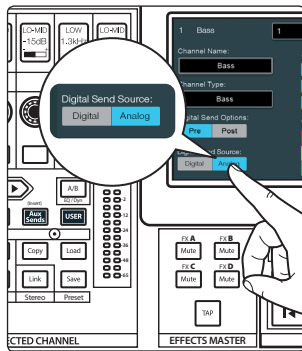

For every channel that you want to source from the local analog inputs and record from the console mixer (either USB or SD), you need to set the Digital Send Source to “Analog”. To do this, navigate to the channel settings on the console mixer and enable the Analog Send Source.

Dinner is Served

Added bonus: PreSonus’ previously Top Secret recipe for... Rice Dressing

Ingredients:

- 1 lb ground beef
- 1 lb chopped chicken liver
- 1 onion (diced)
- 2 green peppers (diced)
- 4-6 celery stalks (diced)
- 2 garlic cloves (minced)
- ¼ C. chopped fresh parsley
- 3 C. chicken stock
- 6 C. cooked rice
- 1 Tbs. oil
- Salt and pepper to taste
- Cayenne pepper to taste

Cooking Instructions:

1. In a large pot, heat oil on medium high and add meat, salt, and pepper to taste. Stir until meat begins to brown.
2. Lower heat and add all vegetables. Cook until onions are transparent and celery is very tender. Add stock as necessary to prevent burning.
3. Stir in cooked rice. Add remaining stock and simmer on low until ready to serve.

StudioLive™ Series III

Stagebox Mode Addendum



18011 Grand Bay Ct. • Baton Rouge,
Louisiana 70809 USA • 1-225-216-7887
www.presonus.com

26092017