

# TASCAM

D01310420B

# CD-A580

## CD Player / Cassette Deck

### OWNER'S MANUAL

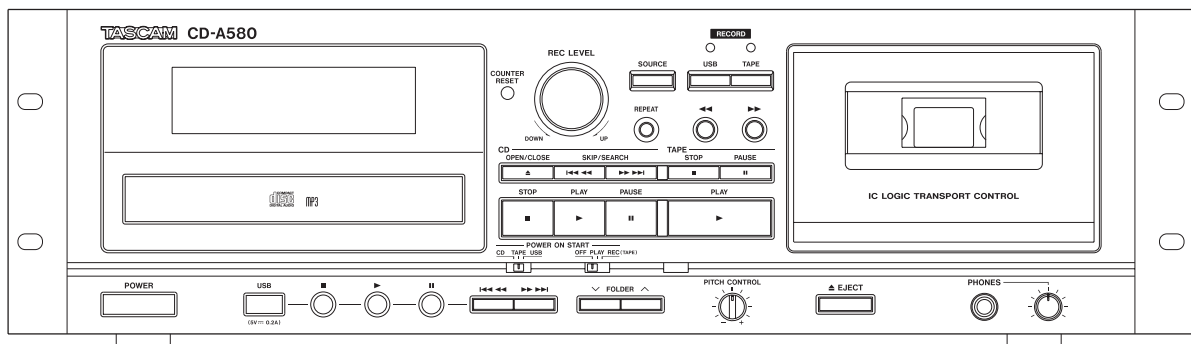

# IMPORTANT SAFETY INSTRUCTIONS

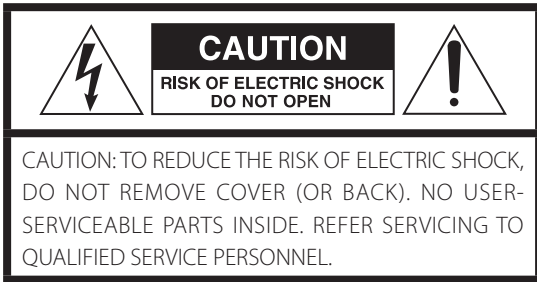

The lightning flash with arrowhead symbol, within an equilateral triangle, is intended to alert the user to the presence of uninsulated "dangerous voltage" within the product's enclosure that may be of sufficient magnitude to constitute a risk of electric shock to persons.



The exclamation point within an equilateral triangle is intended to alert the user to the presence of important operating and maintenance (servicing) instructions in the literature accompanying the appliance.

**WARNING: TO PREVENT FIRE OR SHOCK HAZARD, DO NOT EXPOSE THIS APPLIANCE TO RAIN OR MOISTURE.**

## CAUTION

- DO NOT REMOVE THE EXTERNAL CASES OR CABINETS TO EXPOSE THE ELECTRONICS. NO USER SERVICEABLE PARTS ARE INSIDE.
- IF YOU ARE EXPERIENCING PROBLEMS WITH THIS PRODUCT, CONTACT THE STORE WHERE YOU PURCHASED THE UNIT FOR A SERVICE REFERRAL. DO NOT USE THE PRODUCT UNTIL IT HAS BEEN REPAIRED.
- USE OF CONTROLS OR ADJUSTMENTS OR PERFORMANCE OF PROCEDURES OTHER THAN THOSE SPECIFIED HEREIN MAY RESULT IN HAZARDOUS RADIATION EXPOSURE.

**IN USA/CANADA, USE ONLY ON 120 V SUPPLY.**

- 1) Read these instructions.
- 2) Keep these instructions.
- 3) Heed all warnings.
- 4) Follow all instructions.
- 5) Do not use this apparatus near water.
- 6) Clean only with dry cloth.
- 7) Do not block any ventilation openings. Install in accordance with the manufacturer's instructions.
- 8) Do not install near any heat sources such as radiators, heat registers, stoves, or other apparatus (including amplifiers) that produce heat.
- 9) Do not defeat the safety purpose of the polarized or grounding-type plug. A polarized plug has two blades with one wider than the other. A grounding type plug has two blades and a third grounding prong. The wide blade or the third prong are provided for your safety. If the provided plug does not fit into your outlet, consult an electrician for replacement of the obsolete outlet.

- 10) Protect the power cord from being walked on or pinched particularly at plugs, convenience receptacles, and the point where they exit from the apparatus.

- 11) Only use attachments/accessories specified by the manufacturer.

- 12) Use only with the cart, stand, tripod, bracket, or table specified by the manufacturer, or sold with the apparatus. When a cart is used, use caution when moving the cart/apparatus combination to avoid injury from tip-over.



- 13) Unplug this apparatus during lightning storms or when unused for long periods of time.

- 14) Refer all servicing to qualified service personnel. Servicing is required when the apparatus has been damaged in any way, such as power-supply cord or plug is damaged, liquid has been spilled or objects have fallen into the apparatus, the apparatus has been exposed to rain or moisture, does not operate normally, or has been dropped.

- The apparatus draws nominal non-operating power from the AC outlet with its POWER or STANDBY/ON switch not in the ON position.
- The mains plug is used as the disconnect device; the disconnect device shall remain readily operable.
- Caution should be taken when using earphones or headphones with the product because excessive sound pressure (volume) from earphones or headphones can cause hearing loss.

## CAUTION

- Do not expose this apparatus to drips or splashes.
- Do not place any objects filled with liquids, such as vases, on the apparatus.
- Do not install this apparatus in a confined space such as a book case or similar unit.
- The apparatus should be located close enough to the AC outlet so that you can easily reach the power cord plug at any time.
- If the product uses batteries (including a battery pack or installed batteries), they should not be exposed to sunshine, fire or excessive heat.
- CAUTION for products that use replaceable lithium batteries: there is danger of explosion if a battery is replaced with an incorrect type of battery. Replace only with the same or equivalent type.

## Laser information

This product contains a semiconductor laser system inside the cabinet and is classified as a "CLASS 1 LASER PRODUCT".

To prevent being exposed to the laser beam, do not try to open the enclosure.

### Laser:

Type:	EP-C101
Manufacturer:	GUANGDONG EVER BRIGHT GROUP CO.,LTD
Laser output:	Less than 1 mW on the objective lens
Wavelength:	790 ±25 nm

## Model for USA

This product has been designed and manufactured according to FDA regulations "title 21, CFR, chapter 1, subchapter J, based on the Radiation Control for Health and Safety Act of 1968", and is classified as class **I** laser product. There is not hazardous invisible laser radiation during operation because invisible laser radiation emitted inside of this product is completely confined in the protective housings.

The label required in this regulation is as follows:

For U.S.A.

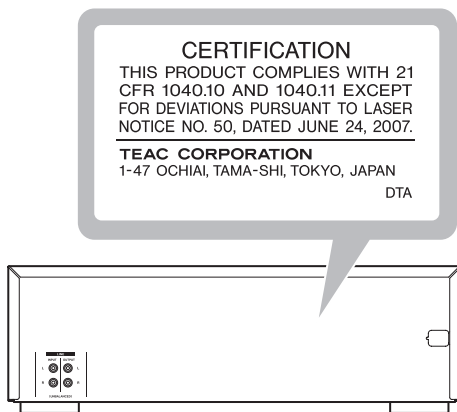

## RACK-MOUNTING THE UNIT

Use the supplied rackmount screw kit to mount the unit in a standard 19-inch rack, as shown in the illustration below. Remove the feet of the unit before mounting.

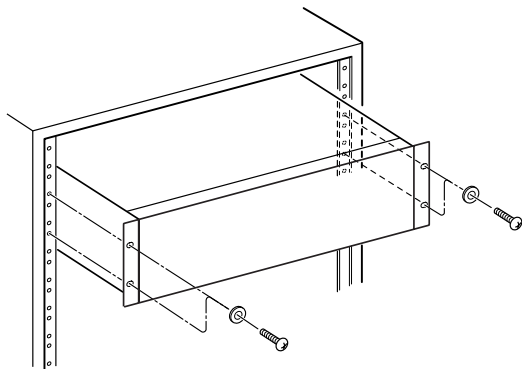

### ATTENTION

- Leave 1U of space above the unit for ventilation.
- Allow at least 10 cm (4 in) at the rear of the unit for ventilation.

## Model for Canada

Industry Canada's Compliance Statement:

This Class B digital apparatus complies with Canadian ICES-003.  
CET APPAREIL NUMÉRIQUE DE LA CLASSE B EST CONFORME À LA  
NORME NMB-003 DU CANADA

## Model for USA

This equipment has been tested and found to comply with the limits for a Class B digital device, pursuant to Part 15 of the FCC Rules. These limits are designed to provide reasonable protection against harmful interference in a residential installation. This equipment generates, uses, and can radiate radio frequency energy and, if not installed and used in accordance with the instructions, may cause harmful interference to radio communications. However, there is no guarantee that interference will not occur in a particular installation. If this equipment does cause harmful interference to radio or television reception, which can be determined by turning the equipment off and on, the user is encouraged to try to correct the interference by one or more of the following measures:

- Reorient or relocate the equipment and/or the receiving antenna.
- Increase the separation between the equipment and receiver.
- Connect the equipment into an outlet on a circuit different from that to which the receiver is connected.
- Consult the dealer or an experienced radio/TV technician for help.

## Model for Europe



This product complies with the European Directives request, and the other Commission Regulations.

## CAUTION

Changes or modifications not expressly approved by the party responsible for compliance could void the user's authority to operate the equipment.



## ⚠ Precautions concerning batteries

Misuse of batteries could cause them to rupture or leak leading to fire, injury or the staining of nearby things. Please read and observe the following precautions carefully.

- Be sure to insert the batteries with correct positive (⊕) and negative (⊖) orientations.
- Use batteries of the same type. Never use different types of batteries together.
- If the remote control is not used for a long time (more than a month), remove the batteries to prevent them from leaking.
- If the batteries leak, wipe away the leakage inside the battery compartment and replace the batteries with new ones.
- Do not use batteries of types other than those specified. Do not mix new batteries with old ones or use different types of batteries together.
- Do not heat or disassemble batteries. Never throw batteries into fire or water.
- Do not carry or store batteries with other metallic objects. The batteries could short circuit, leak or explode.
- Never recharge a battery unless it is confirmed to be a rechargeable type.

## For European Customers

### Disposal of electrical and electronic equipment and batteries and/or accumulators

- a) All electrical/electronic equipment and waste batteries/accumulators should be disposed of separately from the municipal waste stream via collection facilities designated by the government or local authorities.
- b) By disposing of electrical/electronic equipment and waste batteries/accumulators correctly, you will help save valuable resources and prevent any potential negative effects on human health and the environment.
- c) Improper disposal of waste electrical/electronic equipment and batteries/accumulators can have serious effects on the environment and human health because of the presence of hazardous substances in the equipment.
- d) The Waste Electrical and Electronic Equipment (WEEE) symbols, which show wheeled bins that have been crossed out, indicate that electrical/electronic equipment and batteries/accumulators must be collected and disposed of separately from household waste. If a battery or accumulator contains more than the specified values of lead (Pb), mercury (Hg), and/or cadmium (Cd) as defined in the Battery Directive (2006/66/EC), then the chemical symbols for those elements will be indicated beneath the WEEE symbol.  
  

- e) Return and collection systems are available to end users. For more detailed information about the disposal of old electrical/electronic equipment and waste batteries/accumulators, please contact your city office, waste disposal service or the shop where you purchased the equipment.

## Trademarks and copyrights

TASCAM is a trademark of TEAC Corporation, registered in the U.S. and other countries.

Supply of this product does not convey a license nor imply any right to distribute MPEG Layer-3 compliant content created with this product in revenue-generating broadcast systems (terrestrial, satellite, cable and/or other distribution channels), streaming applications (via Internet, intranets and/or other networks), other content distribution systems (pay-audio or audio-on-demand applications and the like) or on physical media (compact discs, digital versatile discs, semiconductor chips, hard drives, memory cards and the like).

An independent license for such use is required. For details, please visit <http://mp3licensing.com>.

MPEG Layer-3 audio coding technology is licensed from Fraunhofer IIS and Thomson.

Other company names, product names and logos in this document are the trademarks or registered trademarks of their respective owners.

Information is given about products in this manual only for the purpose of example and does not indicate any guarantees against infringements of third-party intellectual property rights and other rights related to them.

TEAC Corporation will bear no responsibility for infringements on third-party intellectual property rights or their occurrence because of the use of these products.

With the exception of personal enjoyment and similar uses, copyrighted materials belonging to third parties cannot be used without permission from the rights holders in accordance with copyright law. Please use the equipment appropriately. TEAC Corporation will bear no responsibility for rights infringements committed by users of this product.

# Contents

Thank you for choosing this TEAC product. Read this manual carefully to get the best performance from this unit.

IMPORTANT SAFETY INSTRUCTIONS .....	2
Trademarks and copyrights .....	4
What you can do with this unit .....	5
Before use .....	6
Discs .....	7
Cassette tapes .....	8
USB flash drives .....	9
MP3 files .....	10
Identifying the parts (remote control) .....	10
Identifying the parts (main unit) .....	12
Using the remote control .....	14
Display .....	14
Connections .....	16
Basic operation .....	17
Listening to a CD .....	18
Repeat playback .....	20
Shuffle playback .....	20
Programmed playback .....	21
Listening to a cassette tape .....	24
Listening to files on a USB flash drive .....	26
Recording on a USB flash drive .....	28
Erasing files from a USB flash drive .....	30
Recording on a cassette tape .....	31
Timer-controlled playback and recording .....	34
Automatic power saving function .....	36
Troubleshooting .....	37
MP3 playback order .....	39
Maintenance .....	39
Specifications .....	40

# What you can do with this unit

## Playback

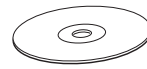

### CD/CD-R/CD-RW (Audio CD/MP3 disc)

➔ "Listening to a CD" on page 18

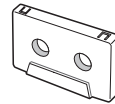

### Cassette tape

➔ "Listening to a cassette tape" on page 24



### MP3 files on a USB flash drive

➔ "Listening to files on a USB flash drive" on page 26

## Recording

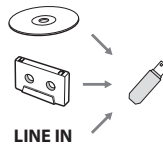

### Record on a USB flash drive from a CD, a cassette tape or an external source

➔ "Recording on a USB flash drive" on page 28

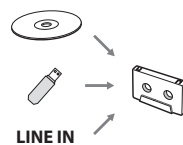

### Record on a cassette tape from a CD, a USB flash drive or an external source

➔ "Recording on a cassette tape" on page 31

## Timer operation

### Requires a commercially-available timer

➔ "Timer-controlled playback and recording" on page 34

Timer-controlled playback



Timer-controlled recording



# Before use

## What's in the box

Confirm that the standard accessories are included.  
Please contact the store where you purchased this unit if any of these items are missing or have been damaged during transportation.

### Remote control (RC-1329) × 1



### Batteries (AAA) for remote control × 2



### Rackmount screw kit × 1

### Owner's manual (this document, including warranty) × 1

- Keep this manual in a safe place for future reference.

## Precautions for use

- Do not move the unit during CD playback.  
During CD playback, the disc rotates at high speed. Do not lift or move the unit during playback. Doing so might damage the disc or the unit.
- The voltage supplied to the unit should match the voltage that is printed on the rear panel. If you are in any doubt regarding this matter, consult an electrician.
- Do not open the cabinet as this might result in damage to the circuitry or electrical shock. If a foreign object should get into the unit, contact your dealer or service company.
- When removing the power plug from the wall outlet, always pull directly on the plug, never yank on the cord.
- Always remove the disc before relocating or moving this unit. Moving the unit with a disc inside it could cause malfunction.

## Precautions for placement and use

- The operating temperature range of this unit is 5–35 °C.
- Do not install this unit in the following types of locations.  
Doing so could make the sound quality worse or cause malfunction.
  - Places with significant vibrations
  - Near windows or other places exposed to direct sunlight
  - Near heaters or other extremely hot places
  - Extremely cold places
  - Places with bad ventilation or high humidity
  - Very dusty locations
- To enable good heat dissipation, do not place anything on top of the unit.
- Do not place this unit on top of a power amplifier or other device that generates heat.

## Beware of condensation

Condensation could occur if the unit is moved from a cold place to a warm place, it is used immediately after a cold room has been heated or it is otherwise exposed to a sudden temperature change. To prevent this, or if this occurs, let the unit sit for one or two hours at the new room temperature before using it.

## Using the TEAC Global Site

You can download updates for this unit from the TEAC Global Site:

**<http://teac-global.com/>**

- 1) Open the TEAC Global Site.
- 2) In the TASCAM Downloads section, click the desired language to open the Downloads website page for that language.

### NOTE

If the desired language does not appear, click Other Languages.

- 3) Click the "Search by Model Name" section to open the Downloads page for that product. (Users in Europe should follow the instructions on screen to select the product.)
- 4) Select and download the updates that are needed.

## Product registration

Customers in the USA, please visit the following TASCAM website to register your TASCAM product online.

**<http://tascam.com/>**

## Discs that can be played by this unit

CDs (12-cm and 8-cm) that bear the "COMPACT disc DIGITAL AUDIO" logo can be played by this unit.



- The logo should be on the disc label or the CD jacket.

CD-R and CD-RW discs that have been correctly recorded in the audio CD format and finalized, as well as finalized CD-R and CD-RW discs that contain MP3 files, can be played by this unit.

This unit can play these types of discs without an adapter. It cannot play any other type of disc.

⚠ Playback of any other type of disc could cause loud noise and damage to speakers as well as harm hearing. Never try to play any other type of disc.

- Depending on the quality of the disc and/or the condition of the recording, some discs might not be playable.
- Video CDs, CD-ROMs and similar types of discs can be read by the unit, but they will make no sound when played back.
- Super Audio CDs cannot be read or played back by this unit.
- Video and audio DVDs, DVD-ROMs and other types of DVDs cannot be read or played back by this unit.

### ATTENTION

If you put a video or audio DVD, DVD-ROM or other type of DVD into the disc tray, the unit will attempt to read the disc and rotate at high speed. If you accidentally insert such a disc, wait until the unit stops spinning before ejecting it in order to avoid possibly damaging the disc. Do not attempt to remove the disc when "READING" appears on the display.

- Copy-protected discs and other discs that do not conform to the CD standard might not play correctly in this player. If you use such discs in this unit, TEAC Corporation and its subsidiaries will not be responsible for any consequences or guarantee the quality of reproduction. If you experience problems with such non-standard discs, you should contact their issuers.

## About CD-R/CD-RW discs

This unit can play back CD-R and CD-RW discs that have been recorded in the audio CD format (CD-DA) and the MP3 format.

- Discs created by a CD recorder must be finalized before use with this unit.
- Depending on disc quality and recording conditions, playback of some discs might not be possible. Please see the manual for the device that you used to create the disc.
- If you are uncertain about the handling of a CD-R or CD-RW disc, please contact the seller of the disc directly.

## Precautions for use

- Do not play any disc that is warped, deformed or damaged. Playing such discs could cause irreparable harm to the playing mechanisms.
- Printable CD-R and CD-RW discs are not recommended because their label sides could be sticky and damage the unit.
- Do not stick paper or protective sheets on discs and do not use any protective coating sprays.
- Never use a stabilizer. Using commercially-available CD stabilizers with this unit will damage the mechanisms and cause them to malfunction.
- Do not use irregularly-shaped discs (octagonal, heart-shaped, business card size, etc.). Such CDs could damage the unit.

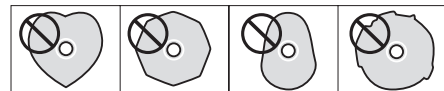

## Handling precautions

- Always place the disc on the disc tray with the label side up. Only one side of a Compact Disc can be played or used for recording.
- To remove a disc from a standard storage case, press down on the case through the center of the disc and lift the disc out, holding it carefully by its edges.



How to remove a disc



How to hold a disc

## Storage precautions

- Discs should be returned to their cases after use to avoid dust and scratches that could cause the laser pickup to "skip."
- Do not expose discs to direct sunlight or high temperature or humidity for extended periods. Long exposure to high temperatures will warp discs.
- CD-R and CD-RW discs are more sensitive to the effects of heat and ultraviolet rays than ordinary CDs. It is important that they not be stored in locations where they will be exposed to direct sunlight. They should also be kept away from sources of heat, such as radiators and heat-generating electrical devices.

## Discs (continued)

### Maintenance

- If a disc becomes dirty, wipe its surface radially from the center hole outward towards the outer edge with a soft, dry cloth.



- Never clean discs using chemicals such as record sprays, antistatic sprays and fluids and thinners. Such chemicals will do irreparable damage to the disc's plastic surface.

If you are in any doubt as to the care and handling of a CD-R or CD-RW disc, read the precautions supplied with the disc or contact the disc manufacturer.

## Cassette tapes

### Tape types

There are several types of cassette tapes.

#### Cassette tapes that can be played by this unit

Normal (type I)    Chrome (type II)    Metal (type IV)

#### Cassette tapes that can be recorded on by this unit

Normal (type I)    Chrome (type II)

### ATTENTION

- Do not open a cassette or pull out the tape.
- Do not touch the tape.

### Storage precautions

- Keep cassette tapes away from magnets or magnetized items because they may cause noise or erase recorded contents.
- Do not leave cassette tapes in a dusty place.
- Do not store cassette tapes in a place with high temperature or humidity.

### Types of cassette tapes that should be avoided

The following types of cassette tapes might prevent the unit from operating or functioning normally. The tape of such cassette tapes could be caught in the unit and cause unexpected problems.

#### Deformed cassette tapes

Cassettes that are deformed, that have tape that does not track properly, or that generate abnormal noise during fast-forwarding or rewinding.

#### Long-duration tapes

Tapes that allow recording for longer than 90 minutes sometimes get caught by the capstan because they are extremely thin and stretch easily. Do not use them.

### Slackening of tapes

Slack tape could get caught in the capstan or other parts. Eliminate slack by using a pencil or similar tool before use.

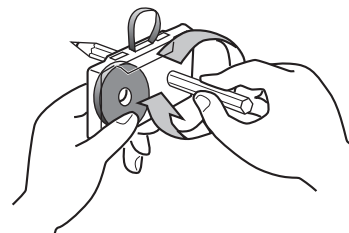



## Automatic tape type detection function

This cassette deck can detect what type of tape is being used based on the detection holes in the cassette shell. Be sure to use cassettes with detection holes.

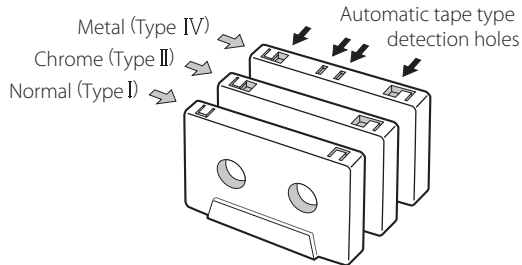

## Accidental erasure prevention tabs

Tabs in the top of the cassette shell allow you to prevent important recordings from being erased by mistake. There are two tabs in each cassette shell—one for “side A” and one for “side B.”

Once these tabs have been removed using a screwdriver or similar tool, there is no chance of the recording function being activated by accident.

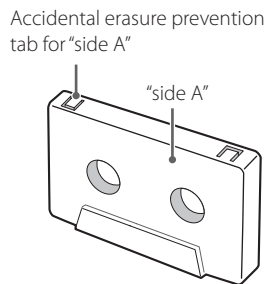

- To record on a cassette that has had its tab broken off, put a piece of adhesive tape over the hole. Be careful not to block the tape type detection holes.

## ATTENTION

**Never turn the unit off or disconnect a USB flash drive when it is being accessed, for example, during writing, playback, recording or the erasure of files.**

**Doing so could damage the unit and the connected USB flash drive.**

## Compatibility

- Only USB flash drive can be used.
- Hard disk drives, CD/DVD drives, and other devices connected via USB cannot be used.
- This unit cannot copy or move files.
- Playable formats: FAT12, FAT16, FAT32
- NTFS, HFS and HFS+ formats cannot be used.
- Max. number of playable folders: 255
- Max. number of playable/recordable files: 999
- Operation with all USB flash drives is not guaranteed. See the TEAC Global Site (<http://teac-global.com/>) for information about USB flash drives that our company has confirmed for operation with this unit.
- When recording from a CD to a USB flash drive, the monitored sound might skip depending on the type of USB flash drive, but this will not affect the recorded data.

## Recording

This unit can record sound from CDs, cassette tapes and connected external devices, including tuners, to USB flash drives in MP3 format. See page 28 for details.

## MP3 files

This unit can play MP3 files that are on CD-R/CD-RW discs and external USB flash drives.

- Playable audio file formats
  - MP3 (with ".mp3" extension)
  - 8–320kbps bit rate
  - 16–48kHz sampling frequency

### NOTE

DRM (Digital Rights Management) is not supported.

- Up to eight levels of subfolders are supported.

### File information display

The display of this unit can only show single-byte letters and numbers.

- If the file information uses Japanese, Chinese or other double-byte characters, playback is possible but the name will not be shown correctly. In such cases, "\*\*\*\*" is displayed.

### Precautions when preparing MP3 files using a computer or other device

- Discs that have not been recorded in accordance with ISO 9660 specifications cannot be played back.
- MP3 files are recognized by the ".mp3" extension. Always include an extension at the end of the file name.
- Files without extensions cannot be recognized. Files that are not in the MP3 data format cannot be played back even if they have an extension.
- After writing to a CD-R/CD-RW, close the session (complete disc creation). If the session has not been closed, the disc cannot be played back.
- This unit can play a maximum of 999 files in a maximum of 255 folders. If data exceed these numbers, proper playback might not be possible for files numbered 1000 or higher and files in folders numbered 256 or higher.
- Discs recorded using multiple sessions are not supported. Only the first session will be played back.
- Depending on the disc condition, this unit might not be able to play some discs or skipping could occur.
- Files protected by DRM cannot be played back by this unit.

## Identifying the parts (remote control)

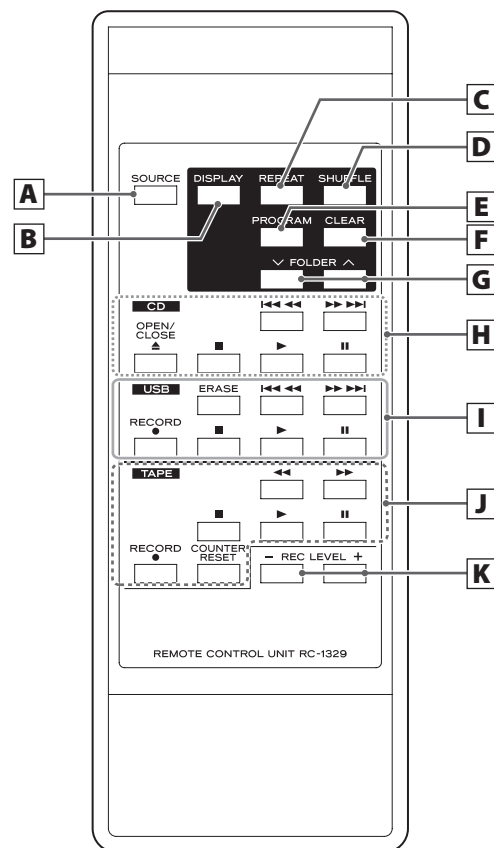

If both the main unit and the remote control have buttons with the same function, we only explain procedures using one of them in this manual. However, the other can also be used in the same manner.

**A SOURCE button**

Use this button to select a source (page 17).

**B CD USB DISPLAY button**

Press this button to change the display information (page 15).

**C CD USB REPEAT button**

Use this button to set the repeat function (page 20).

**D CD USB SHUFFLE button**

Use this button to start shuffle playback (page 20).

**E CD USB PROGRAM button**

Use this button to program tracks/files (page 21).

**F CD USB CLEAR button**

Use this button to clear programmed tracks/files (page 23).

**G CD USB FOLDER (∨/∧) buttons**

Use these buttons to select MP3 folders (pages 19 and 27).

**H CD****Skip (I◀◀/▶▶I)/Search (◀◀/▶▶) buttons**

Press these buttons to skip through tracks/files.  
Hold down these buttons to search for part of a track/file.

**OPEN/CLOSE (▲) button**

Press this button to open and close the disc tray.

**Stop (■) button**

Press this button to stop playback.

**Play (▶) button**

Press this button to start playback.

**Pause (⏸) button**

Press this button to pause playback. To resume playback, press this button again.

**I USB****ERASE button**

Use this button to erase files from a USB flash drive (page 30).

**Skip (I◀◀/▶▶I)/Search (◀◀/▶▶) buttons**

Press these buttons to skip through files.  
Hold down these buttons to search for a part of a file.

**RECORD (●) button**

Use this to record to an external USB flash drive. Press it once to enable recording standby, and press it again to start recording. (page 28)

Press it during recording to divide the file at that point (page 30).

**Stop (■) button**

This stops USB flash drive recording/playback.

**Play (▶) button**

Press this button to start playback.  
When in USB recording standby, press this to start recording.

**Pause (⏸) button**

Press this button to pause playback or recording.  
Press this button again to resume playback or recording.

**J TAPE****Stop (■) button**

Press this button to stop playback.  
Press this button to stop recording to a tape.

**Play (▶) button**

This starts cassette tape playback.  
Press when a cassette tape is paused to resume playback/recording.

**Pause (⏸) button**

Press this button to pause playback or recording.  
Press this button again to resume playback or recording.

**ATTENTION**

When stopped, pressing the Pause (⏸) button will not put the tape into a paused state.

**Fast-forward/Rewind (◀◀/▶▶) buttons**

Press these buttons to fast-forward/rewind the tape.

**RECORD (●) button**

Use to record to a tape. Press it once to enable recording standby, and press it again to start recording (page 31).

**COUNTER RESET button**

Press this button to reset the tape counter to "0000".

**K REC LEVEL (-/+ ) buttons**

Use these buttons to adjust the recording level.

# Identifying the parts (main unit)

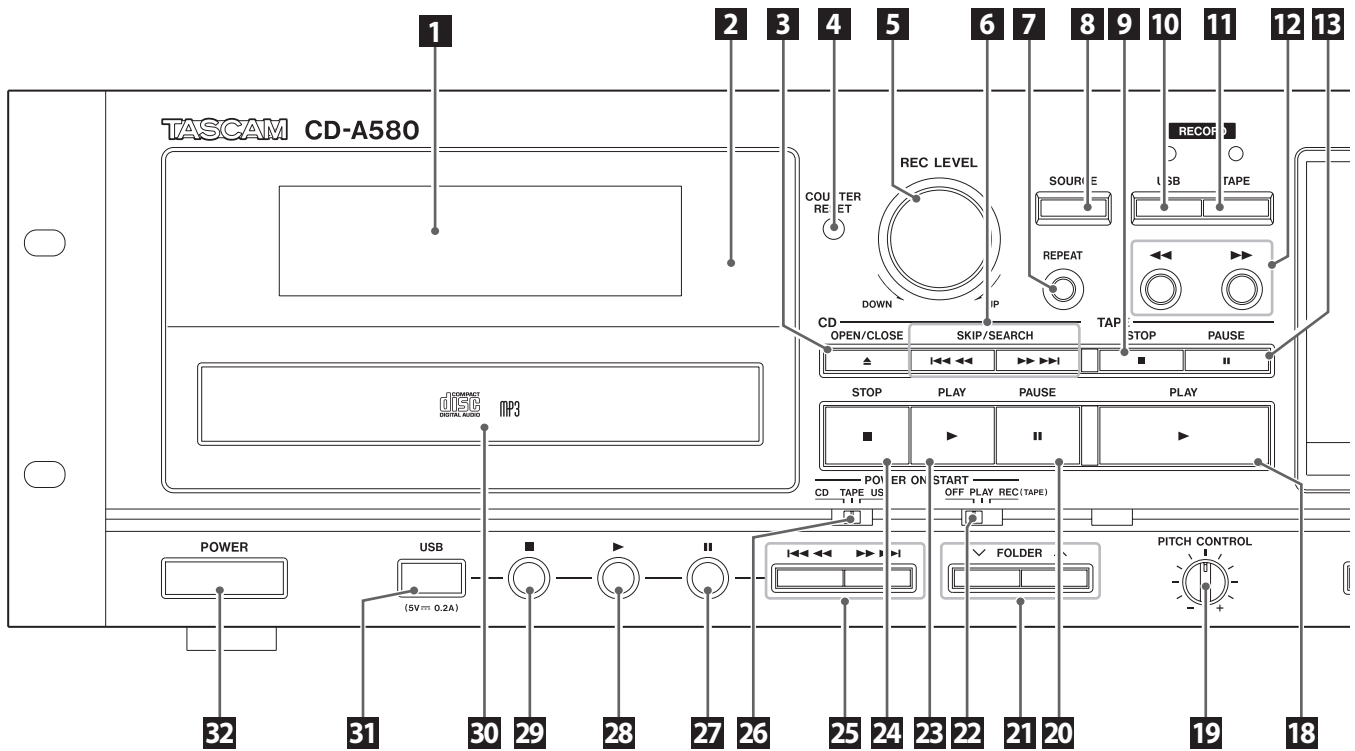

## 1 Display

This shows the total number of tracks/files, playback time and other information (page 14).

## 2 Remote sensor

When operating the remote control, point it towards here.

## 3 CD OPEN/CLOSE (▲) button

Press this button to open and close the disc tray.

## 4 TAPE COUNTER RESET button

Press this button to reset the tape counter to "0000".

## 5 REC LEVEL knob

Turn this knob to adjust the recording level.

## 6 CD Skip (|◀◀/▶▶|)/Search (◀◀/▶▶) buttons

Press these buttons to skip through tracks/files.  
Hold down these buttons to search for part of a track/file.

## 7 CD USB REPEAT button

Use this button to set the repeat function (page 20).

## 8 SOURCE button

Use this button to select the source (page 17).

## 9 TAPE Stop (■) button

Press this button to stop cassette tape playback.  
Press this button to stop recording to a tape.

## 10 RECORD USB button

Use to record to an external USB flash drive. Press it once to enable recording standby, and press it again to start recording (page 28).

Press it during recording to divide the file at that point (page 30).

## 11 RECORD TAPE button

Use to record to a tape. Press it once to enable recording standby, and press it again to start recording (page 31).

## 12 TAPE Fast-forward/Rewind (◀◀/▶▶) buttons

Press these buttons to fast-forward/rewind the cassette tape.

## 13 TAPE Pause (||) button

Press this button to pause cassette tape playback or recording.  
Press this button again to resume playback or recording.

## 14 TAPE Cassette tape compartment

## 15 Headphone knob (PHONES)

Use the headphone knob to adjust the headphone output level.

## 16 Headphone jack (PHONES)

Use this standard stereo jack to connect stereo headphones. Use an adapter to connect headphones with mini plugs.

## 17 TAPE EJECT (▲) button

When the tape is stopped, press this button to open the cassette tape compartment.

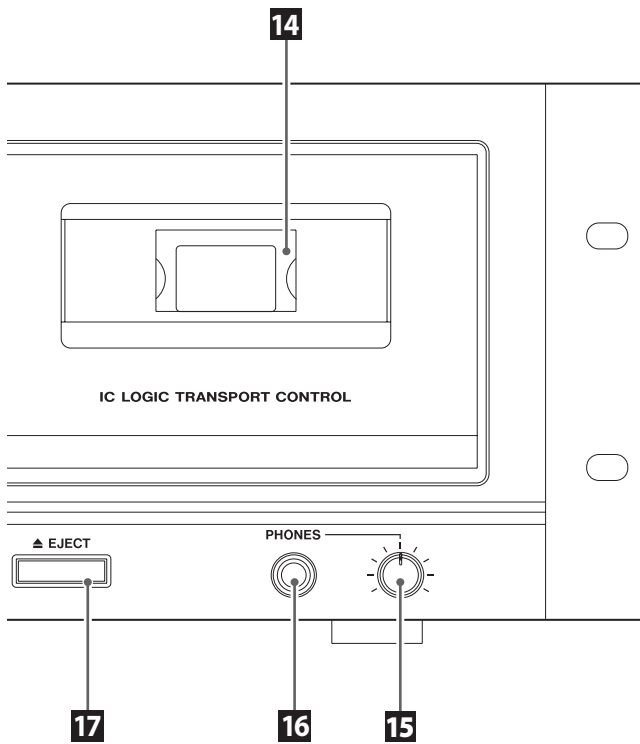

**18 TAPE Play (▶) button**

This starts cassette tape playback.  
Press when a cassette tape is paused to resume playback/recording.

**19 TAPE PITCH CONTROL knob**

Turn this knob to vary the playback speed (page 25).

**20 CD Pause (||) button**

Press this button to pause CD playback. To resume playback, press this button again.

**21 CD USB FOLDER (∨/∧) buttons**

Use these buttons to select folders (pages 19 and 27).

**22 POWER ON START OFF-PLAY-REC (TAPE) switch**

Use this switch to set the timer operation mode (off, play or record).  
To use this when set to play or record, connect a commercially-available programmable timer to this unit (page 34).

- Select OFF to not use timer playback or recording.

**23 CD Play (▶) button**

Press this button to start CD playback.

**24 CD Stop (■) button**

Press this button to stop CD playback.

**25 USB Skip (|◀◀/▶▶|)/Search (◀◀/▶▶) buttons**

Press these buttons to skip through files.  
Hold down these buttons to search for part of a file.

**26 POWER ON START CD-TAPE-USB switch**

Use this switch to set the sound source that is active when the power is turned on.  
Use this switch to set the media used for timer playback/recording. (The timer recording can only record to cassette tape.)  
To use timer playback/recording, connect a commercially-available programmable timer to this unit (page 34).

**27 USB Pause (||) button**

Press this button to pause USB playback or recording.  
Press this button again to resume playback or recording.

**28 USB Play (▶) button**

Press this button to start USB playback.  
When in USB recording standby, press this to start recording.

**29 USB Stop (■) button**

Press this button to stop USB playback.  
Press this button also to stop recording to USB.

**30 CD Disc tray**

**31 USB USB port**

Connect an external USB flash drive here.

**32 POWER button**

Press this button to turn the unit on or off.

**ATTENTION**

**Never turn the unit off or disconnect a USB flash drive when it is being accessed, for example, during writing, playback, recording or the erasure of files.**

**Doing so could damage the unit and the connected USB flash drive.**

## Using the remote control

### Precautions when using the remote control



#### CAUTION

Misuse of batteries could cause them to rupture or leak, which might result in fire, injury or the staining of nearby materials. Please read and observe the precautions on page 3 carefully.

- Use the remote control within the following range.  
Operation distance  
Within 7 m (23 ft) and 15° to the left or right of the front
- Do not place obstructions between the main unit and the remote control.
- Even if the remote control is used within its effective range, operation by remote control might not be possible if there are any obstacles between the unit and the remote control.
- If the remote control is operated near other devices that generate infrared rays, or if other remote controls that use infrared rays are operated near the unit, this unit and the other devices might not operate correctly.

### Battery installation

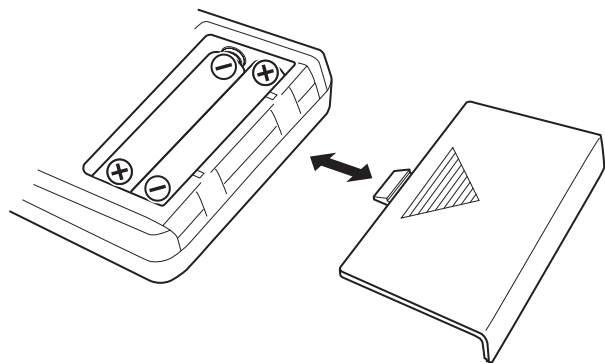

1. Remove the battery compartment cover.
2. Insert two AAA batteries. Make sure that they are inserted with their positive (+) and negative (-) poles oriented correctly.
3. Close the cover.

### Battery replacement

If the distance from the main unit that the remote control works effectively decreases, the batteries are probably exhausted. Replace the batteries with new ones when this happens.

For more information about the collection of batteries, please contact your local municipality, your waste disposal service or the place where you purchased them.

## Display

### CD mode

#### During playback

##### Audio CD

Elapsed time of current track (min./sec.)



Currently playing track number

##### MP3 disc

Currently playing file number  
(starting with 001 in each folder)

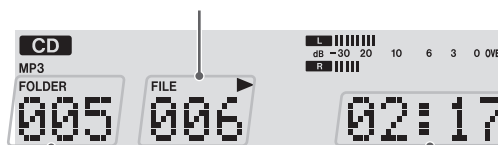

Currently playing folder number

Elapsed time of current track  
(min./sec.)



Currently playing file name  
(scrolls when long)

#### When playback is stopped

##### Audio CD

Total playing time



Total tracks

##### MP3 disc

Total number of files

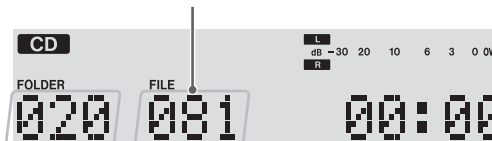

Total number of folders

## TAPE mode



Tape counter

- The tape counter shows the approximate position of the tape. This is not a time indication.

## USB mode

### During playback

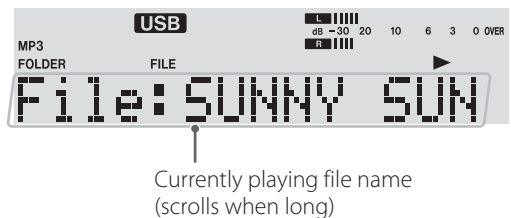
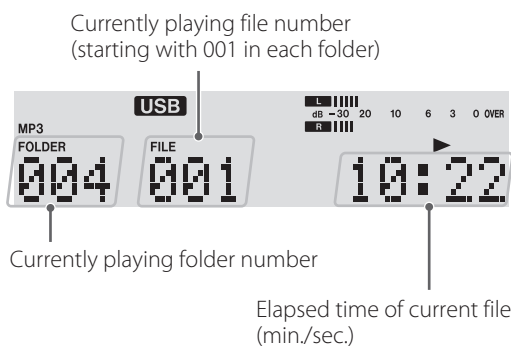

### When playback is stopped

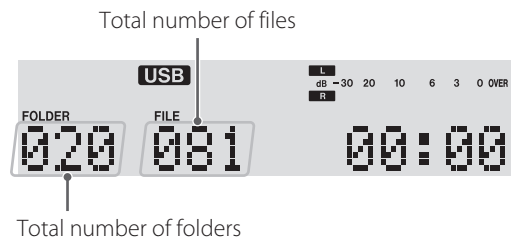

## Recording mode

(Example: Recording on a cassette tape from a USB flash drive)

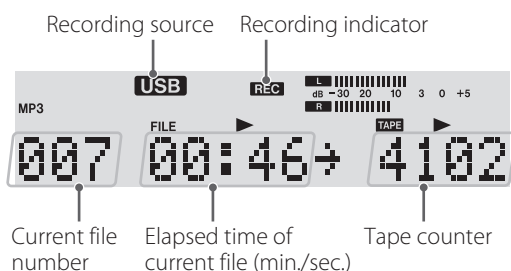

## Changing the display (CD/USB mode)

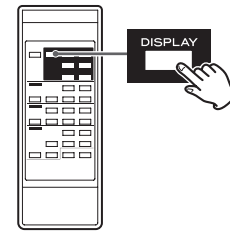

During playback in CD mode or USB mode, each time the DISPLAY button is pressed, the display changes as follows:

### Audio CD

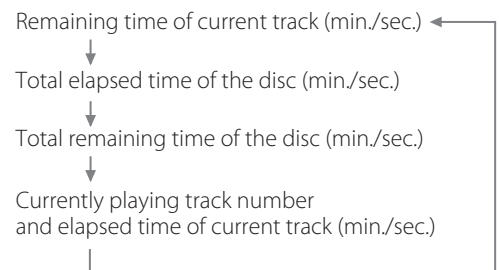

### MP3 disc/USB

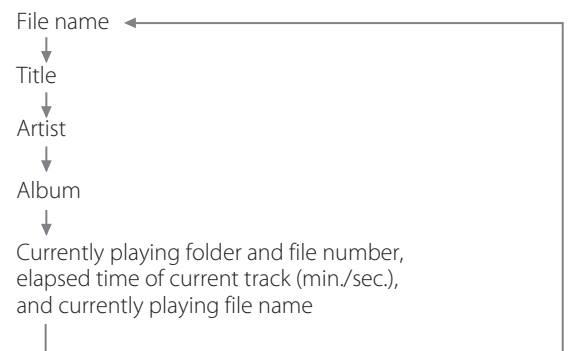

- “No title,” “No album” or “No artist” appears when there is no information.
- “\*\*\*\*” appears when the unit cannot read the information.
- The display of this unit can only show single-byte letters and numbers. If a file name uses Japanese, Chinese or other double-byte characters, playback is possible but the name will not be shown correctly. In such cases, “\*\*\*\*” is displayed.

# Connections

**⚠ Complete all other connections before turning the unit on.**

- Read the instructions of each device that you intend to use with this unit.
- Be sure to connect each plug securely. Do not bundle connecting cables with power cords. Doing so could cause noise.

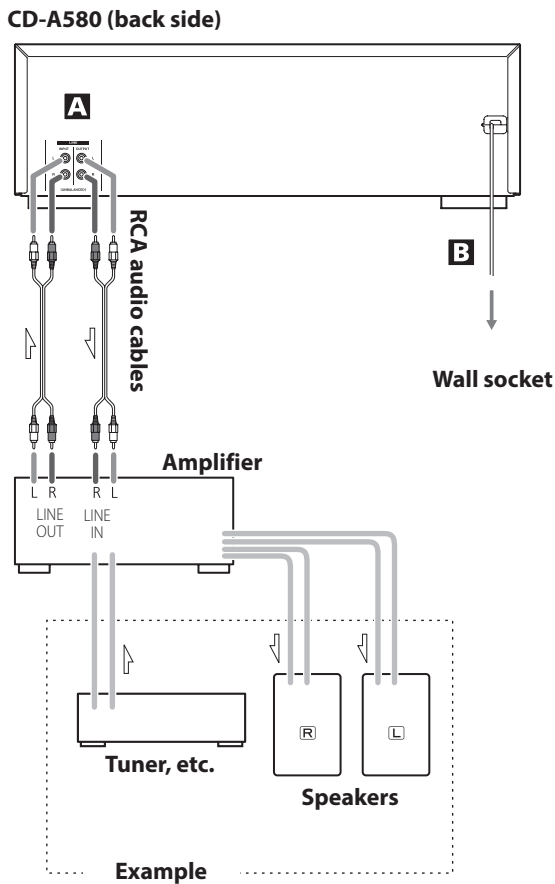

## **A** LINE IN/OUT connectors

These connectors transmit an analog 2-channel audio signal. Connect a stereo amplifier, mixer or other equipment to this unit's analog audio input and output connectors.

Use commercially-available RCA audio cables for connections.

Connect this unit's R input connector to the R output connector of the audio output device, and this unit's L input connector to the L output connector of the other device.

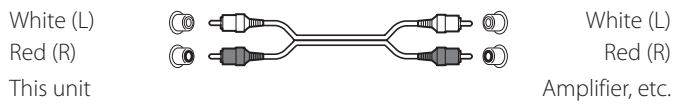

## **B** AC Power Cord

After all other connections are complete, connect the plug to an AC wall outlet.

- ⚠ Be sure to connect the power cord to an AC outlet that supplies the correct voltage.
- ⚠ Hold the power plug when plugging it into an outlet or unplugging it. Never pull or yank on the power cord.

## **Notes on turning on or off the power**

When an amplifier is connected to the unit, turn on or off the power of the unit and the amplifier in the following sequence.

When turning on the power

1. This unit
2. Amplifier

When turning off the power

1. Amplifier
2. This unit



# Basic operation

## Turning the unit on or off

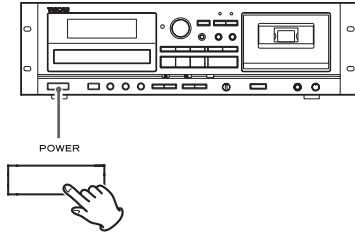

Press the POWER button to turn the unit on or off. When the unit turns on, the display lights.

Check the POWER ON START switches that determine what the unit does when the power is turned on.

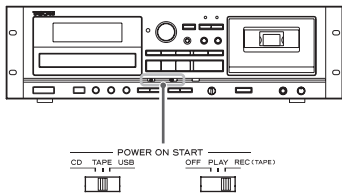

**When the power is turned on, and the POWER ON START OFF-PLAY-REC (TAPE) switch for the timer is set to PLAY or REC**

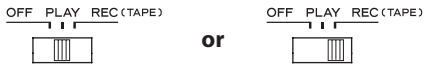

**The source set with the POWER ON START CD-TAPE-USB switch starts playback/recording.**

The timer recording can only record to cassette tape (page 35).

**When the power is turned on, and the POWER ON START OFF-PLAY-REC (TAPE) switch for the timer is set to OFF**



**The source set with the POWER ON START CD-TAPE-USB switch becomes the active source.**

- When you do not want to use the timer, be sure to set the POWER ON START OFF-PLAY-REC (TAPE) switch to the OFF position to prevent accidentally recording over an important cassette tape.

## Automatic power saving function (European models only)

See "Automatic power saving function" on page 36.

## Selecting a source for playback/recording

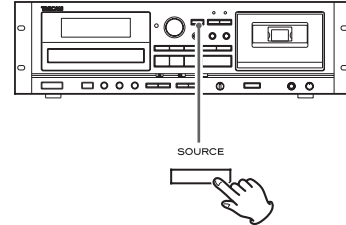

Each time the SOURCE button is pressed, the source changes as follows:

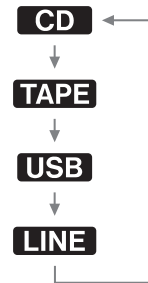

The selected source is shown on upper left of the display.

- During recording, the source cannot be changed.
- Pressing the play button for a source also selects and starts playback of that source.
- Select "LINE" to use an external source connected to the LINE connectors.

# Listening to a CD

- 1** Press the SOURCE button repeatedly to select "CD".

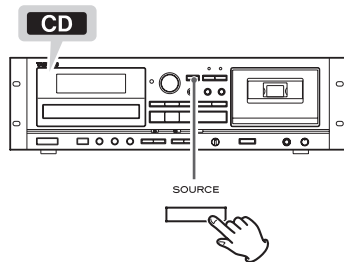

- When a different source is selected, pressing the CD Play (▶) button automatically selects the CD and, if a disc is loaded, starts playback.

- 2** Press the CD OPEN/CLOSE (▲) button to open the disc tray.

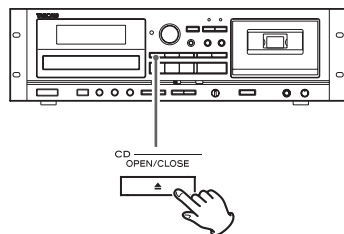

- 3** Place a disc on the tray with the label side up.

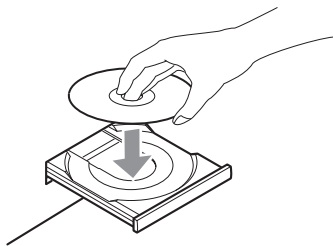

- Always confirm that the disc is centered on the tray. The disc must be centred on the disc tray. If a disc is not correctly loaded, it might not be possible to open the tray again after it has been closed.

### ATTENTION

- Do not load more than one disc.
  - Do not force the tray by hand when opening and closing it.
  - Do not attach adhesive labels or similar materials to either side of a disc.
  - Do not use irregularly-shaped discs.
- Failure to follow any of the above could cause malfunction.

- 4** Press the CD OPEN/CLOSE (▲) button again to close the tray.

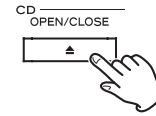

### CAUTION

**Be careful not to let your finger be pinched by the tray.**

Loading a disc takes a few seconds.

During loading, "READING" appears on the display and no buttons will work. Wait until the total number of tracks/files is displayed.

- When no disc is loaded, "NO DISC" is displayed.

- 5** Press the CD Play (▶) button to start playback.

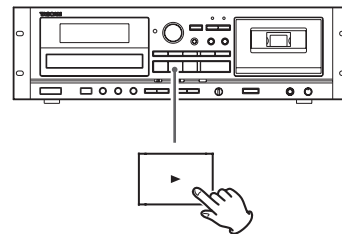

Playback starts from the first track/file on the disc.

- If you load a disc, and then press the CD Play (▶) button without having first closed the disc tray, the disc tray closes and playback starts.
- When playback of all the tracks/files has finished, the unit stops automatically.
- MP3 files that are not placed in folders are automatically put in the "ROOT" folder. Playback starts from the first file in the ROOT folder.
- See page 39 for information about the playback order of MP3 discs.

## Suspending playback temporarily (Pause mode)

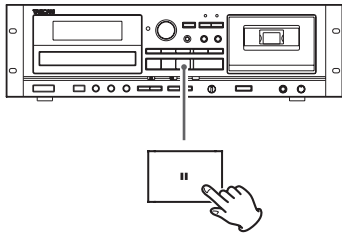

Press the CD Pause (||) button during playback to stop playback at the current position.  
To resume playback, press the CD Pause (||) button again or press the CD Play (▶) button.

## Stopping playback

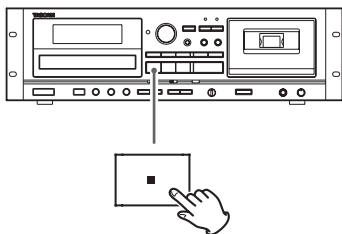

Press the CD Stop (■) button to stop playback.

## Opening the disc tray

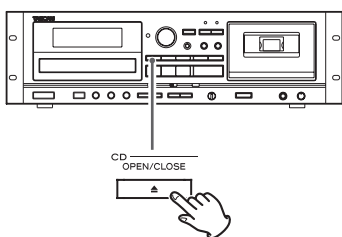

Press the CD OPEN/CLOSE (▲) button to open the disc tray.

- You can also open the tray when in modes other than CD mode.

## Search for a part of a track/file

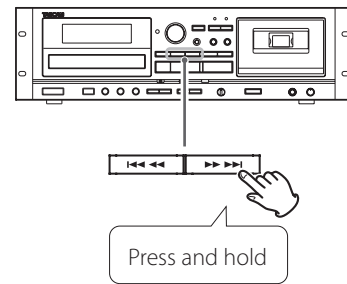

During playback, hold down a CD Search (◀◀ or ▶▶) button to search a part of a track/file. Release it when you find the beginning of the part you want to hear.

## Skipping to an earlier or later track/file

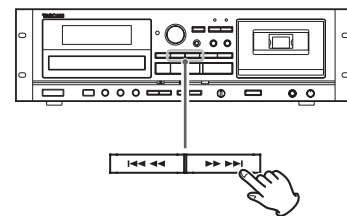

### During playback

Press a CD Skip (◀◀/▶▶) button repeatedly until the desired track/file is selected. The selected track/file will be played from the beginning.

- If the ◀◀ button is pressed once during playback, the track/file being played will be played again from its beginning. To return to the beginning of the previous track/file, press the ◀◀ button twice.

### When playback is stopped or paused

Press a CD Skip (◀◀/▶▶) button repeatedly to select the track/file you want to hear. Then, press the CD Play (▶) button or CD Pause (||) button to start playback of the selected track/file.

## Selecting a folder (MP3 disc)

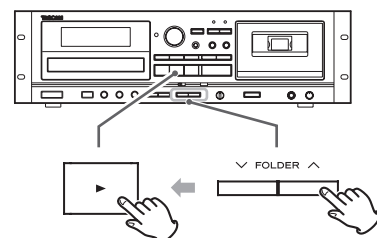

Press the FOLDER (▼/▲) buttons to select a folder. Then, press the CD Play (▶) button to start playback.

## Repeat playback

This function can be used in CD and USB modes.

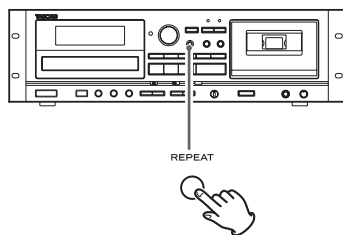

Press the REPEAT button to cycle through the following playback modes:

### Audio CD

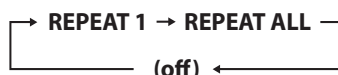

### MP3



- If any of the following buttons are pressed, the repeat mode will be canceled.

#### In CD mode

POWER button, SOURCE button, CD OPEN/CLOSE (▲) button, REPEAT button, SHUFFLE button

#### In USB mode

POWER button, SOURCE button, REPEAT button, SHUFFLE button

### REPEAT 1 (Repeat one track/file)

The track/file being played will be played repeatedly. "REPEAT 1" appears on the display.

- If you use the CD/USB Skip (◀◀ or ▶▶) buttons to select a different track/file, that track/file will be played repeatedly.
- You can select a track/file to be repeated when playback is stopped. Press the REPEAT button, select a track/file using the CD/USB Skip (◀◀ or ▶▶) buttons, and then press the CD/USB Play (▶) button or CD/USB Pause (⏸) button to start playback.

### REPEAT ALL (Repeat all tracks/files)

All the tracks/files on the disc will be played repeatedly. "REPEAT ALL" appears on the display.

- During program playback, the programmed tracks/files will be played repeatedly.

### REPEAT FOLDER (Repeat all the files in a folder) (MP3 only)

All the files in the selected folder will be played repeatedly. "REPEAT FOLDER" appears on the display.

## Shuffle playback

This function can be used in CD and USB modes.

Use this function to play the tracks/files on a disc/USB flash drive in random order.

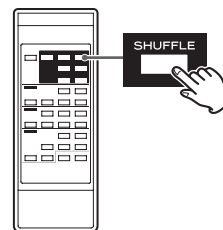

Pressing the SHUFFLE button turns the shuffle mode on and off.

During shuffle playback, "SHUFFLE" appears on the display.

After playing back all tracks/files, the unit exits the "Shuffle" playback mode and stops playback.

To stop shuffle playback, press the CD/USB Stop (■) button.

- If you press the ▶▶ button during shuffle playback, the next track/file will be randomly selected and played. If you press the ◀◀ button, the currently played track/file will be played from the beginning. During shuffle playback, a track/file that has completed playback will not be played again.
- The shuffle function does not work during program playback.
- If any of the following buttons are pressed, shuffle mode will be canceled.

#### In CD mode

POWER button, SOURCE button, CD OPEN/CLOSE (▲) button, REPEAT button, SHUFFLE button

#### In USB mode

POWER button, SOURCE button, REPEAT button, SHUFFLE button

# Programmed playback

This function can be used in CD and USB modes.

Up to 30 tracks/files can be programmed in the desired order.

**1** When playback is stopped, press the PROGRAM button to enter program mode.

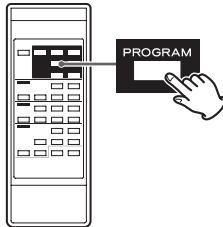

"PROGRAM" blinks and "P-01" appears on the display.

Example when in CD mode



- To stop programming, press the CD/USB Stop (■) button.

**2** (When programming MP3 files)

Press the CD/USB FOLDER (∨/∧) buttons to select a folder, then press the PROGRAM button.

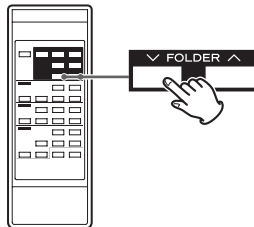

- MP3 files not located in a specific folder are in the "001" (ROOT) folder.

**NOTE**

The ROOT folder is the top-level folder.

**3** Press the CD/USB Skip (I◀◀ or ▶▶I) buttons to select a track/file, then press the PROGRAM button.

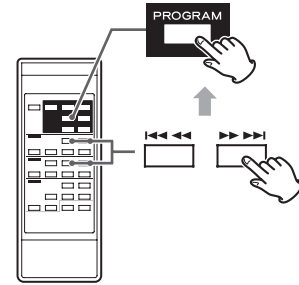

The track/file is programmed, and "P-02" is displayed.

- Repeat steps **2** and **3** to program more tracks/files.
- You can program up to 30 tracks/files.
- To stop programming, press the CD/USB Stop (■) button. Programming is canceled, but the program contents are retained in memory. If you want to restart program playback, press the PROGRAM button, and then press the CD/USB Play (▶) button.

**4** When the selection of track/file numbers is completed, press the CD/USB Play (▶) button to start program playback.

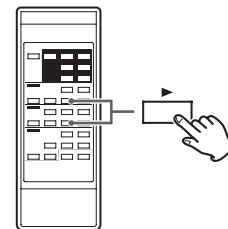

To stop program playback, press the CD/USB Stop (■) button.

- After program playback finishes, press the PROGRAM button and then the CD/USB Play (▶) button to play the program again.
- You can use the CD/USB Skip (I◀◀ and ▶▶I) buttons during program playback to select and play other tracks/files in the program.
- The shuffle function does not work during program playback.
- "REPEAT 1" and "REPEAT ALL" playback are possible during program playback. When set to "REPEAT ALL" mode, the programmed tracks/files will be played repeatedly.

## Programmed playback (continued)

### Adding tracks/files to the end of the program

When playback is stopped, press the PROGRAM button repeatedly until "TRACK 00" appears on the display.

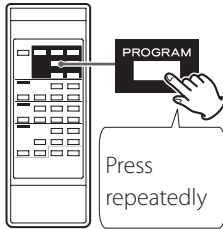

Select a track/file number you want to add using the CD/USB Skip (◀◀ and ▶▶) buttons, and then press the PROGRAM button.

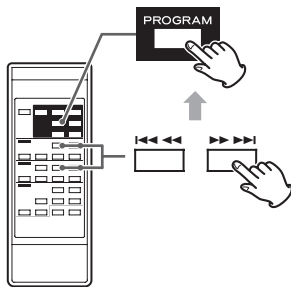

The track/file is added to the end of the program.

### Overwriting part of the program

When playback is stopped, press the PROGRAM button repeatedly until the program number of the track that you want to change appears on the display.

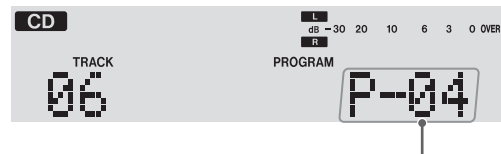
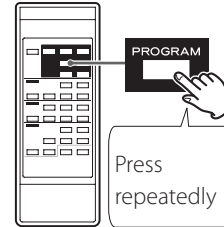

Program number to be changed

Select the track/file number that you want to add using the CD/USB Skip (◀◀ and ▶▶) buttons, and then press the PROGRAM button.

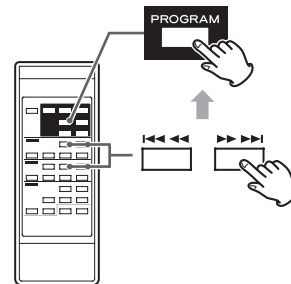

The selected track/file is added to the program, replacing the track that had been at that program number before.

## Checking the program order

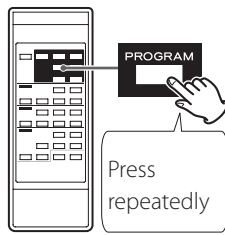

When playback is stopped, press the PROGRAM button repeatedly. The numbers of the programmed tracks/files and their program numbers will be shown in order.

## Deleting tracks/files from the program

When playback is stopped, press the PROGRAM button repeatedly **until the program number of the track to be deleted appears** on the display.

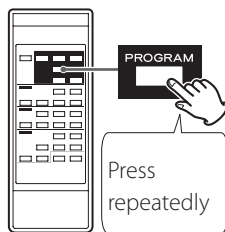

Program number to be deleted

Press the CLEAR button.

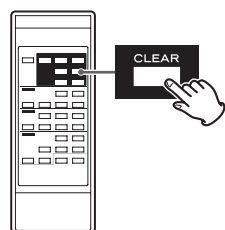

The track/file is deleted from the program.

## Clearing the program

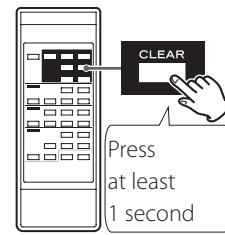

When playback is stopped, press the PROGRAM button, followed by the CLEAR button or CD/USB Stop (■) button more than 1 second. The PROGRAM indicator disappears and all the contents of the program are cleared.

- If the PROGRAM indicator is not shown, press the PROGRAM button to activate program mode before pressing the CLEAR button.
- If one of the following buttons is pressed, the contents of the program are also cleared.

### In CD mode

POWER button, CD OPEN/CLOSE (▲) button, SOURCE button

### In USB mode

POWER button, SOURCE button

## Exiting program mode

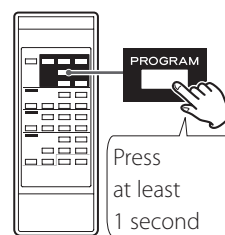

When playback is stopped, press and hold the PROGRAM button more than 1 second or press the CD/USB Stop (■) button. The PROGRAM indicator will disappear.

- This does not clear the contents of the program. Press the PROGRAM button again and then press the CD/USB Play (▶) button if you want to restart program playback.

# Listening to a cassette tape

You can play Normal (type I), Chrome (type II) and Metal (type IV) tapes with this unit.

**1** Press the **SOURCE** button repeatedly to select "TAPE".

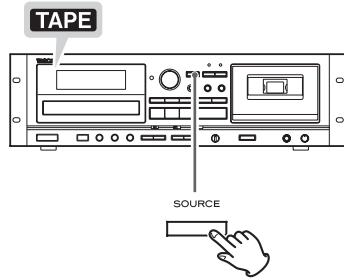

- When a different source is selected, starting tape playback automatically selects the tape.

**2** Press the **TAPE EJECT** (▲) button to open the cassette tape compartment.

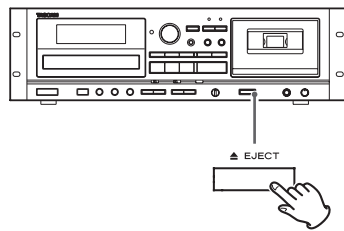

**3** Put a cassette tape in the compartment.

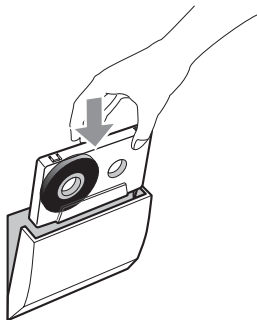

Insert the cassette tape with its open edge facing down and the side that you want to play facing you. Then, close the cassette compartment by pushing its door in.

**ATTENTION**

- Do not use deformed or slack cassette tapes. The tape could become tangled, and the cassette might become stuck in the unit.
- Do not force the door of the compartment by hand when opening it.

Failure to follow any of the above could cause malfunction.

**4** Press the **TAPE play** (▶) button to start playback.

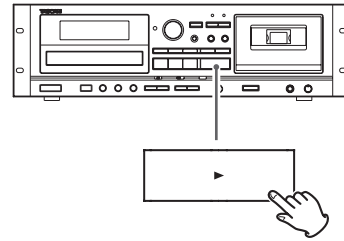

## Pausing playback temporarily

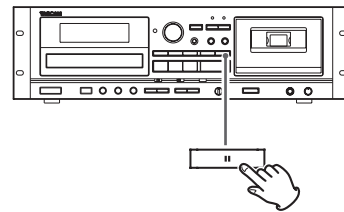

Press the **TAPE Pause** (⏸) button during playback to stop playback at the current position.

To resume playback, press the **TAPE Pause** (⏸) button again or press the **TAPE Play** (▶) button.

## Stopping playback

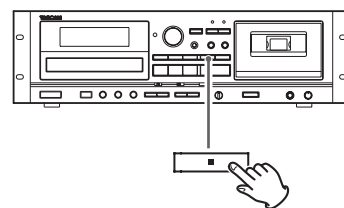

Press the **TAPE Stop** (■) button to stop playback.



## Opening the cassette tape compartment

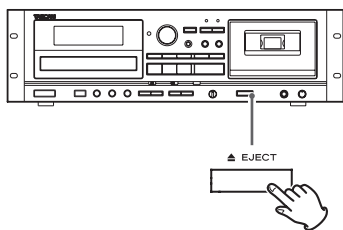

When the tape is stopped, press the TAPE EJECT ( $\blacktriangle$ ) button to open the cassette tape compartment.

- Do not press the TAPE EJECT ( $\blacktriangle$ ) button during playback.
- You can also open the compartment when in modes other than TAPE mode.

## Fast-forwarding/Rewinding a tape

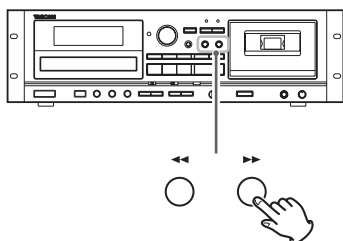

Press the Fast-forward ( $\blacktriangleright\blacktriangleright$ ) button or the Rewind ( $\blacktriangleleft\blacktriangleleft$ ) button to wind the tape rapidly.

Winding stops when the end of the tape is reached. To stop winding before the end, press the TAPE Stop ( $\blacksquare$ ) button.

- You can wind the tape when CD/USB/LINE is selected as a source. These buttons do not, however, function when in a recording mode.

## Pitch control

This control varies the pitch of the music during playback.

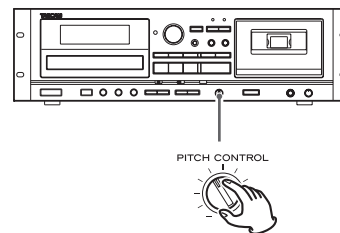

Turning the PITCH CONTROL knob clockwise increases the playback speed and raises the pitch by a maximum of +10%. Turning the PITCH CONTROL knob counterclockwise reduces the playback speed and lowers the pitch by a maximum of -10%.

- This does not function when recording to tape.
- Keep it set to the 12 o'clock (vertical) position for normal pitch.
- Pitch control can be used when recording from a cassette tape to a USB flash drive.

## Tape counter

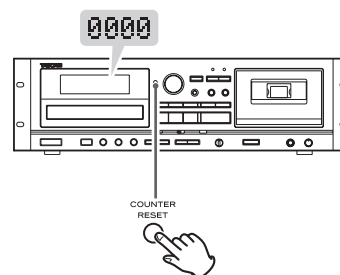

Press the COUNTER RESET button to reset the tape counter to "0000". You can use this function to easily locate any desired point on the tape.

# Listening to files on a USB flash drive

**ATTENTION**

Never turn the unit off or disconnect a USB flash drive when it is being accessed, for example, during writing, playback, recording or the erasure of files. Doing so could damage the unit and the connected USB flash drive.

**1** Press the SOURCE button repeatedly to select "USB".

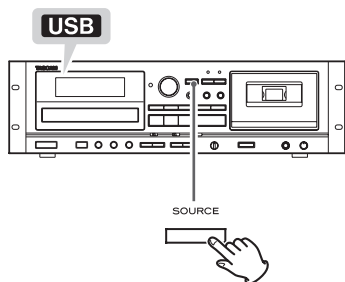

- When a different source is selected, starting USB playback automatically selects the USB mode.

**2** Connect an external USB flash drive to the USB port of this unit.

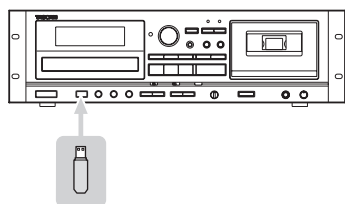

Reading the USB flash drive takes a few seconds. USB flash drives with especially large capacities might take more time. When "READING" is shown while the drive is being read, pressing buttons will have no effect.

- If no MP3 file is on the USB flash drive, "NO MUSIC FILE" is displayed.

**3** Press the USB Play (▶) button to start playback.

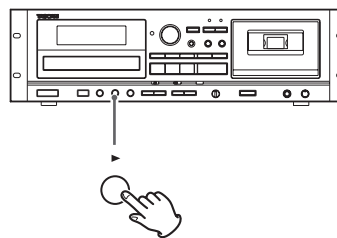

- When playback of all the files has finished, the unit stops automatically.
- MP3 files that are not put in folders are automatically put in the "ROOT" folder. Playback starts from the first file in the ROOT folder.
- See page 39 for information about the playback order of MP3 files.

## Pausing playback temporarily

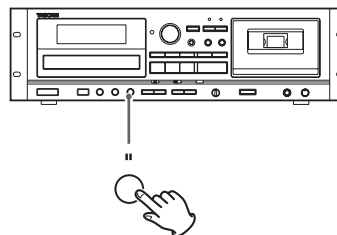

Press the USB Pause (||) button during playback to stop playback at the current position. To resume playback, press the USB Pause (||) button again or press the USB Play (▶) button.

## Stopping playback

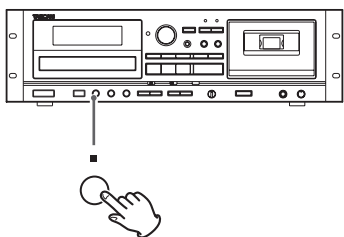

Press the USB Stop (■) button to stop playback.

## Search for a part of a file

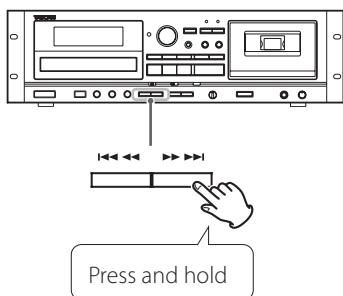

During playback, hold down a USB Search (◀◀ or ▶▶) button to search for a part of a file. Pressing and holding a Search button increases the search speed.

Release it when you find the beginning of the part that you want to hear.

## Skipping to an earlier or later file

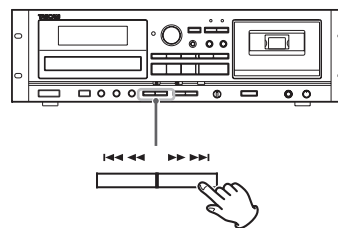

### During playback

Press a USB Skip (◀◀/▶▶) button repeatedly until the desired file is selected. The selected file will be played from the beginning.

- If the ◀◀ button is pressed once during playback, the file being played will be played again from the beginning. To return to the beginning of the previous file, press the ◀◀ button twice.

### When playback is stopped or paused

Press a USB Skip (◀◀/▶▶) button repeatedly to select the file you want to hear. Then, press the USB Play (▶) button or USB Pause (⏸) button to start playback of the selected file.

## Selecting a folder

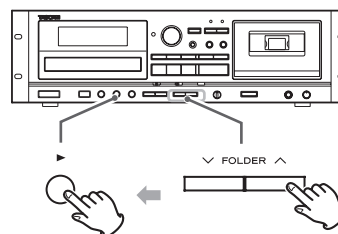

Press the FOLDER (▼/▲) buttons to select a folder. Then, press the USB Play (▶) button to start playback.

## Repeat, shuffle and programmed playback

These functions can be used in USB mode.

Please see the following sections for details about using them.

- Repeat playback** → page 20
- Shuffle playback** → page 20
- Programmed playback** → page 21

## Recording on a USB flash drive

This unit can record sound from a CD, cassette tape or connected external device in MP3 format to a USB flash drive.

- This unit can also record to cassette tape, but it cannot record to both USB flash drive and tape at the same time.
- Correct recording might not be possible depending on the USB flash drive. If this occurs, try using a different USB flash drive.
- This unit cannot record to a USB flash drive with the timer recording function.
- When recording from a CD to a USB flash drive, the monitored sound might skip depending on the type of USB flash drive, but this will not affect the recorded data.

### ATTENTION

**Do not disconnect the USB flash drive during recording. Do not turn the unit off or disconnect the power cord during recording. Doing so might cause damage to the unit and the connected USB flash drive.**

### About recorded MP3 files

- When recording, "RECORD" folder is automatically created and a subfolder for each source ("CD", "TAPE" or "LINE") is also created in the "RECORD" folder. MP3 files are added to the corresponding subfolder.
- File names are assigned automatically with a numerical endings in order.

#### When recorded from a CD

"CD001.MP3", "CD002.MP3" ...

If there are, for example, files named "CD004.MP3" and "CD009.MP3" in the USB folder already, and you make a recording, the next new file will be named "CD010.MP3".

#### When recorded from a cassette tape

"T001.MP3", "T002A.MP3" ...

#### When record from an external source

"L001.MP3"

- During recording from a tape or LINE input, you can divide the file manually (page 30). In this case, consecutive numbers are added to the ends of the file names.

#### Example:

If "T001.MP3" is divided, files named "T001.MP3" and "T002.MP3" are created.

- This unit can record up to 999 files to a USB flash drive. However, if the USB flash drive already contains files, those files are included in the maximum total of 999 files when recording.
- The maximum time possible for a recorded file is 240 minutes.
- Tracks recorded onto a USB flash drive are converted to MP3 files at a bit rate of 128 kbps.

- 1 Connect an external USB flash drive to the USB port of this unit.**

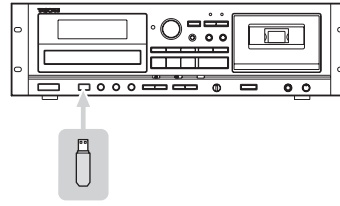

- You cannot record to an external USB flash drive if there is no free space or the device is locked.
- Before recording, check the remaining capacity of the USB flash drive using a PC. You cannot check the remaining memory capacity with this unit.

- 2 Press the SOURCE button repeatedly to select the source to be recorded (CD, TAPE, or LINE).**

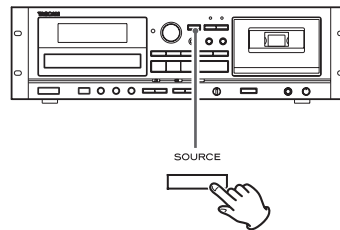

- 3 Press the RECORD USB button to start recording standby.**

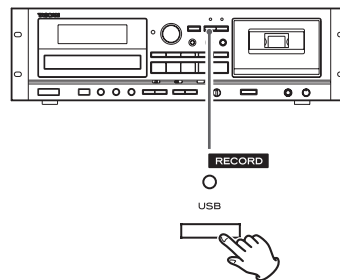

The red indicator above the RECORD USB button and the **REC** icon on the display blink.

- Preparation for USB recording takes a few seconds. USB flash drives with especially large capacities might take more time. When "Record prepare" is shown during preparation, pressing buttons will have no effect.
- To stop recording, press the USB Stop (■) button.

#### 4 (When recording from a tape or an external source) Adjust the recording level.

Before recording, adjust the recording level. Failure to do so could cause the recorded sound to be distorted or noisy.

1. Play the source (cassette tape or external source) to be recorded.
2. Use the REC LEVEL knob to adjust the recording level so that the loudest sound never lights the "OVER" indicator on the peak level meter.

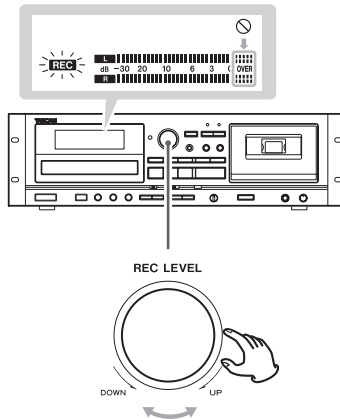

- Different sources to be recorded have different volumes. In order to record at the optimal volume for each source, it is necessary to adjust the recording level for each source.
- When recording from a CD, the recording level does not need to be changed, and it cannot be adjusted.

#### 5 Prepare the recording source.

##### Recording from a CD

To record all the tracks/files on a CD, stop the disc first. To record only some of the tracks/files on a CD, pause at the beginning of the part that you want to record.

You can also record tracks in programmed order. For information about how to set the program, see page 21.

##### Recording from a cassette tape

To record the entire tape, rewind the tape to its starting point. To record from the middle of a tape, stop or pause at the point from where you want to start recording.

##### Recording from an external source

Prepare to start playback of the source device.

**Example:** Set the source selection of an amplifier.  
Set the playback media in a connected player.  
To record from a tuner, tune in a station.

#### 6 Press the RECORD USB button again to start recording.

When recording from an external source, you must also start playback of that source.

If the recording source is a CD or cassette tape, that source will automatically start playing back.

- Pressing either the USB Pause (||) or USB Play (▶) button will start recording.

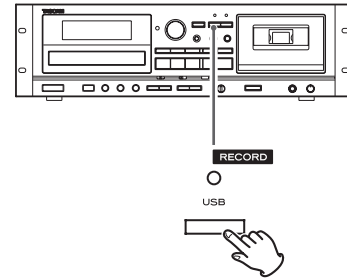

The red indicator above the RECORD USB button and the **REC** icon on the display stop blinking.

- If the USB flash drive runs out of open space during recording, recording stops automatically.
- To pause recording, press the USB Pause (||) button. A second press of the button resumes recording.  
Pressing the RECORD USB or USB Play (▶) button will also resume recording. You can also resume recording by pressing the source playback button if the recording source is a CD or tape.

##### Recording from a CD or a cassette tape

When source playback stops, recording also automatically stops. To stop recording, press the USB Stop (■) button. Doing this also stops playback of the recording source.

##### Recording from an external source

When source playback stops, recording does not automatically stop. Press the USB Stop (■) button to stop recording.

## Recording on a USB flash drive (contd.)

### Manual file division

When recording from a tape or a device connected to the LINE inputs, you can manually divide the MP3 file as it is being recorded. This function cannot be used when recording from a CD. A recorded CD will automatically be divided at each track.

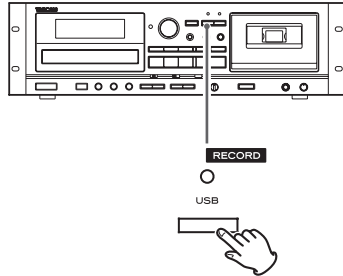

During recording, press the RECORD USB button at the point where you want to divide the recorded file. File division takes about 10 seconds.

- "File increment" appears on the display during division.
- "Record Ending" will appear when you press the USB stop (■) button.

#### When recording from a tape:

During file division, the tape stops, but almost no gap in the recording should occur.

#### When recording from the LINE inputs:

During file division, a gap will occur in the recording.

- This unit cannot divide an already recorded MP3 file. This function only works during recording.
- Consecutive numbers are added to the end of the file names after division.

#### Example:

If "T001.MP3" is divided, files named "T001.MP3" and "T002.MP3" are created.

## Erasing files from a USB flash drive

### ATTENTION

**Do not disconnect the USB flash drive during erasing. Do not turn the unit off or disconnect the power cord during erasing. Doing so might cause damage to the unit and the connected USB flash drive.**

### Erasing all files

### ATTENTION

**Using this function will erase all the contents of a USB flash drive. Non-audio files that are not recognized by this unit will also be erased. Confirm that this is acceptable before beginning this operation.**

- 1 Press the SOURCE button repeatedly to select "USB".**

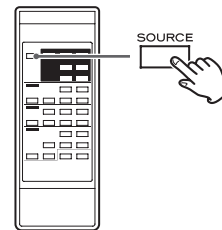

- 2 Connect an external USB flash drive to the USB port of this unit.**

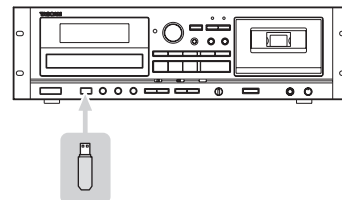

- 3 Press the ERASE button for more than 2 seconds.**

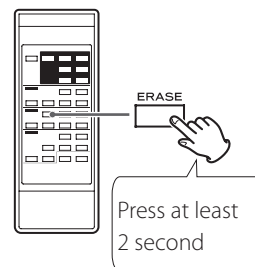

"Erase all?" appears on the display.

- 4 Within 6 seconds, press the ERASE button again.**



The USB flash drive is completely erased. "NO MUSIC FILE" appears on the display.

## Recording on a cassette tape

### Erasing a file

**1** Select the file that you want to delete (page 27).

**2** Press the ERASE button.

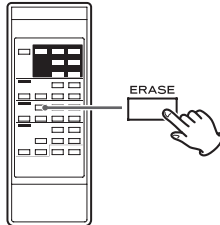

"Erase File?" appears on the display.

**3** Within 6 seconds, press the ERASE button again.

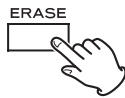

"Erasing" appears on the display, the file currently being played is erased, and playback stops.

This unit can record sound from a CD, USB flash drive, or connected external device to a cassette tape.

You can record on Normal (type I) and Chrome (type II) tapes with this unit. Metal (type IV) cannot be recorded with this unit.

- This unit can also record to a USB flash drive, but it cannot record to both USB flash drive and tape at the same time.

#### ATTENTION

**Never turn the power off or disconnect the power cord during recording. Doing so could damage this unit and connected equipment.**

**1** Put a cassette tape in the compartment.

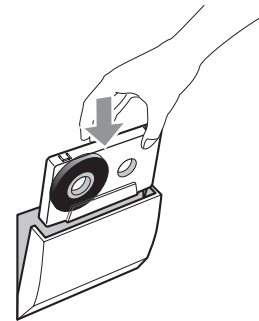

- If the erasure prevention tabs of the cassette tape have been broken off, put pieces of adhesive tape over the hole(s).

**2** Press the SOURCE button repeatedly to select the source to be recorded (CD, USB, or LINE).

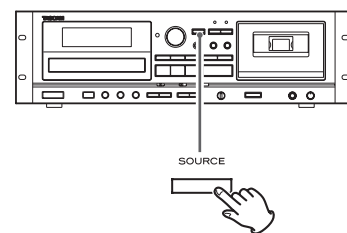

## Recording on a cassette tape (continued)

- 3** Press the **RECORD TAPE** button to start recording standby.

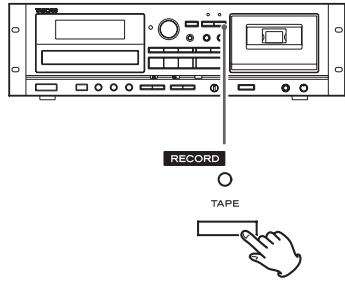

The red indicator above the RECORD TAPE button and the **REC** icons on the display blink.

- To stop recording, press the TAPE Stop (■) button.

- 4** **Adjust the recording level.**

Before recording, adjust the recording level. Failure to do so could cause the recorded sound to be distorted or noisy.

1. Play the source (external source) to be recorded.
2. Adjust the REC LEVEL knob so that the peak level meter never exceeds 0 continuously.

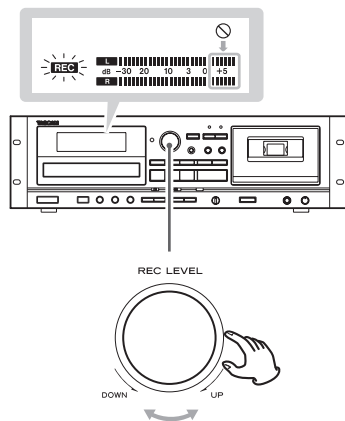

- Different sources to be recorded have different volumes. In order to record at the optimal volume for each source, it is necessary to adjust the recording level for each source.

- 5** **Prepare a recording source.**

### Recording from a CD

To record all the tracks/files on a CD, stop the disc first. To record only some of the tracks/files on a CD, pause at the beginning of the part that you want to record.

You can also record tracks in programmed order. For information about how to set the program, see page 21.

### Recording from a USB flash drive

To record the entire contents of the USB flash drive, stop the unit. To record from the middle of the USB flash drive, pause at the point from where you want to start recording.

You can also record tracks in programmed order. For information about how to set the program, see page 21.

- See page 39 for information about the playback order of MP3 files.

### Recording from an external source

Prepare to start playback of the source device.

- Example:** Set the source selection of an amplifier.  
Set the playback media in a connected player.  
To record from a tuner, tune in a station.



## 6 Press the RECORD TAPE button again to start recording.

When recording from an external source, you must also start playback of the source.

If the recording source is a CD or USB flash drive, that source will automatically start playing back.

- Pressing either the TAPE Pause (⏸) or TAPE Play (▶) button will start recording.

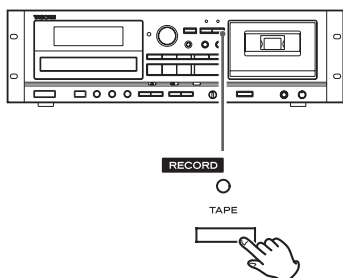

The red indicator above the RECORD TAPE button and the **REC** icon on the display stop blinking.

- To pause recording, press the TAPE Pause (⏸) button. Press the button again to resume recording.

Pressing the RECORD TAPE or TAPE Play (▶) button will also resume recording. You can also resume recording by pressing the source playback button if the recording source is a CD or USB flash drive.

### Recording from a CD or a USB flash drive

When source playback stops, recording also automatically stops. To stop recording, press the TAPE Stop (■) button. Doing this also stops playback of the recording source.

### Recording from an external source

When source playback stops, recording does not automatically stop. Press the TAPE Stop (■) button to stop recording.

## Erasing recordings

When you make a recording, the tape is overwritten (the previous recording is erased). You can erase a tape recording by setting the recording level to MIN and recording silence.

### 1 Press the TAPE RECORD button to start recording standby.

### 2 Set the REC LEVEL control to the minimum MIN position.

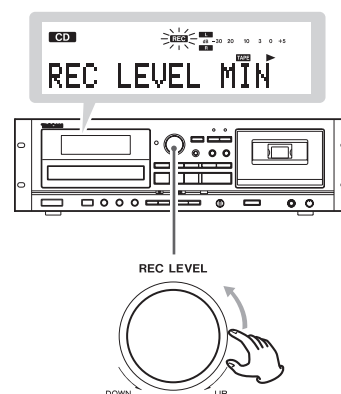

### 3 Press the TAPE RECORD button to start erasing (by recording silence).

# Timer-controlled playback and recording

Connecting a commercially-available programmable timer to your audio setup lets you wake up to your favorite music or start recording at specified times.

- The source for timer playback must be CD, TAPE or USB. Timer playback does not work with external devices connected to the LINE inputs.
- The timer recording source can only be an external device connected to the LINE inputs. And the timer recording can only record to cassette tape.

## Connections

Referring to the illustration below, connect your audio equipment.

To make a timer-controlled recording of a radio program, set your tuner as required.

Set the input/output selectors and other options to their proper positions.

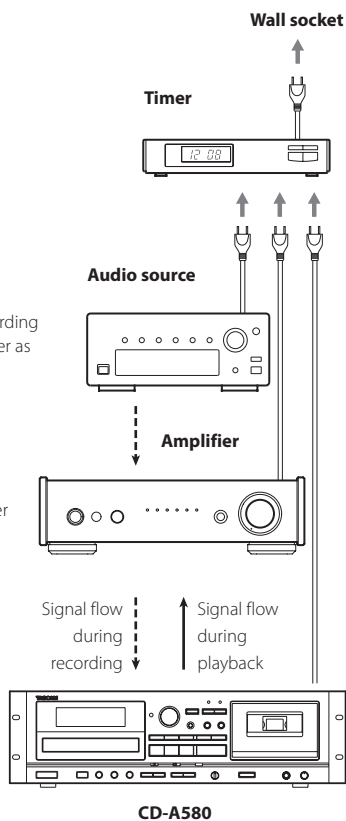

**!** Complete all other connections before turning the unit on.

- Read the instructions of each device that you intend to use with this unit.
- Be sure to connect each plug securely. Do not bundle connecting cables with power cords. Doing so could cause noise.

## Timer-Controlled Playback ( **CD** **USB** **TAPE** )

- The source for timer playback must be CD, TAPE or USB. Timer playback does not work with an external device connected to the LINE input.

**1** Connect this unit and a stereo system to a commercially-available programmable timer (see the previous section).

**2** Set the power switch of all components to ON.

**3** Prepare the source for timer playback.

**4** Set the POWER ON START CD-TAPE-USB switch to the desired source for timer playback.

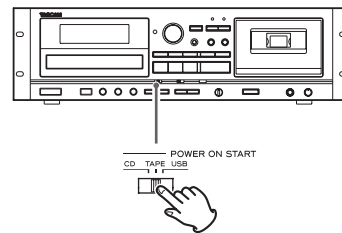

**5** Set the POWER ON START OFF-PLAY-REC (TAPE) switch to the PLAY position.

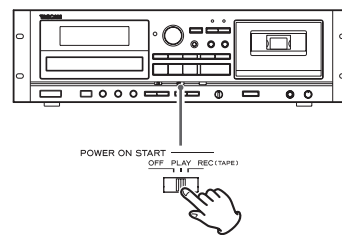

"TIMER" appears on this unit's display.

**6 Set the programmable timer to your desired start (power on) and stop (power off) times.**

When this setting is completed, the power to all components should be turned off.

**At this time, do not press this unit's POWER button. Leave the button pushed in (the on position). If the POWER button is in the off position, timer playback will not function.**

When the preset start time is reached, power will be supplied and playback will start automatically.

- When you do not want to use the timer, set the POWER ON START OFF-PLAY-REC (TAPE) switch to the OFF position.

---

### Timer-Controlled Recording ( **LINE** → **TAPE** )

- The timer recording source can only be an external device connected to the LINE inputs. And the timer recording can only record to cassette tape.

#### (Example: Recording a broadcast program)

**1 Connect this unit and a stereo system to a commercially-available programmable timer (see page 34).**

**2 Set the power switches of all components to ON.**

**3 Prepare the cassette tape that you want to record to with timer recording.**

If the erasure prevention tabs of the cassette tape have been broken off, put pieces of adhesive tape over the hole(s).

You can record on Normal (type I) and Chrome (type II) tapes with this unit.

**ATTENTION**

Load the cassette tape with the side to be recorded facing forward. Be careful not to put a tape in backward and accidentally erase an important recording.

**4 Set the POWER ON START CD-TAPE-USB switch to TAPE.**

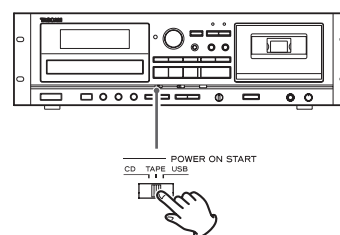

- This function cannot be used to record to USB flash drives. It can only be used to record to cassette tapes.

**5 Set the POWER ON START OFF-PLAY-REC (TAPE) switch to the REC position.**

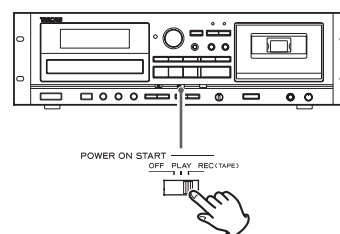

"TIMER" and **REC** appear on this unit's display.

- If the POWER ON START CD-TAPE-USB switch is not set to TAPE, "INVALID" will be shown and timer recording will not be possible.

**6 Tune in the station that you want to record (when recording from radio).**

## Timer-controlled playback and recording (contd.)

### 7 Adjust the recording level.

Failure to do so could cause the recorded sound to be distorted or noisy.

Adjust the REC LEVEL knob so that the peak level meter never exceeds 0 continuously.

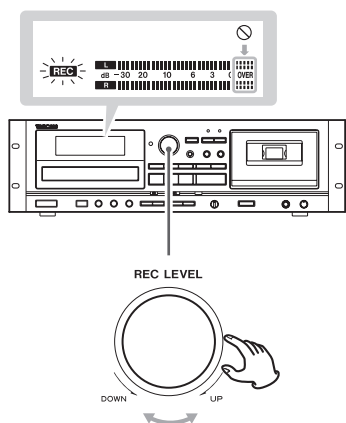

### 8 Set the programmable timer to your desired start (power on) and stop (power off) times.

When this setting is completed, the power to all components will be switched off.

## Automatic power saving function

### ATTENTION

The automatic power saving function is only included in European models.

The automatic power saving function is ON when this unit is shipped new, so it will automatically enter standby if 30 minutes pass under the conditions shown below.

Status	CD	USB flash drive	Cassette tape
No disc , cassette tape or connection	✓	✓	✓
Stopped	✓	✓	✓
Recording paused	/	-	-

- ✓ Automatic power saving function active
- Automatic power saving function not active
- / Not applicable

To reactivate the unit after it has entered standby automatically, press any button on the main unit or the remote control.

- If pressing the POWER button on the main unit, you must press it twice.

## Changing the automatic power saving setting

### 1 Press the SOURCE button to select CD.

### 2 Press the CD OPEN/CLOSE (▲) button to open the disc tray.

### ATTENTION

- Do not close the disc tray until the following steps are completed.
- The disc tray will close automatically if one minute passes without operation.

### 3 Press the REPEAT button for at least 5 seconds to show the current setting ("ERP ON" or "ERP OFF").

### 4 Use the CD Skip (|◀◀/▶▶|) buttons to change the setting, and press the REPEAT button to confirm the change.

### 5 Press the CD OPEN/CLOSE button to close the disc tray.

If you experience a problem with the unit, please take a moment to review the following information before requesting service. Moreover, the problem might be caused by something other than this unit. Please also check the operation of the connected units.

If these measures do not solve the problem, please contact the store where you purchased this unit or TEAC customer support service.

---

## General

### No power

- ➔ Check the connection to the AC power source. Confirm that the AC source is not a switched outlet, and, if it is, that the switch is turned on. Confirm that there is power to the AC outlet by plugging another device such as a lamp or a fan into the outlet.

### The unit turns off automatically (European models only).

- ➔ This is because the automatic power saving function turned it off. Press any button on the main unit or the remote control to turn it on. Change the automatic power saving setting if necessary (page 36).

### Remote control does not work.

- ➔ Press the POWER switch of the main unit to turn it on.
- ➔ If the batteries are exhausted, change the batteries.
- ➔ Use the remote control within its effective range (23 ft/7 m) and point it toward the remote sensor on the front panel.
- ➔ Make sure that there are no obstacles between the remote control and the main unit.
- ➔ If a fluorescent light is near the unit, turn it off.

### Other devices with remote controls operate incorrectly.

- ➔ Other devices with remote controls might operate incorrectly because of infrared light "overspill" when you operate the remote control of this unit.

### Buttons do not work properly.

- ➔ If another operation is still in process, wait a moment and try again.

### No sound or only a very low sound level is heard.

- ➔ Check the connections to the amplifier.
- ➔ Check that the speakers and other audio components are connected securely.
- ➔ Check the operation of the connected component.
- ➔ There might be a ⊕/⊖ short in a speaker cable. Check the speaker cables.
- ➔ Select the correct input source using the SOURCE button.

### Severe hum or noise is heard.

- ➔ Place the unit as far away from TVs as possible.

---

## CD player

### Will not play

- ➔ Load a disc with the label side up.
- ➔ If the disc is dirty, clean the surface of the disc. If the disc is scratched or has any sticky substance on its surface, do not play the disc until you have corrected the condition of the disc. Never under any circumstances use after-market stick-on labels or "disc enhancement" devices that sit on top of or wrap around a disc.
- ➔ If a blank disc has been loaded, load a prerecorded disc.
- ➔ Depending on the disc and other factors, playback of some CD-R/RW discs might not be possible. Try again with another disc.
- ➔ You cannot play unfinalized CD-R/RW discs. Finalize such a disc in a CD recorder and try again.

### Sound skips.

- ➔ Place the unit in a stable place to avoid vibrations and shocks.
- ➔ If the disc is dirty, clean its surface.
- ➔ Do not use scratched, damaged or warped discs.

### Cassette tape recorder

#### Cassette tape compartment does not close.

- The cassette tape is not properly loaded. Reinsert it.

#### Sound quality is poor.

- Clean the heads (page 39).

#### Playback speed seems somewhat fast or slow.

- Check the pitch control setting (page 25).

#### Cannot record

- If the erasure prevention tabs on top of the cassette are broken off, cover the holes using pieces of adhesive tape.
- Check the recording level setting (page 32).

### USB flash drive

#### No sound even if the USB Play (▶) button is pressed.

- Confirm that there are MP3 files on the USB flash drive.
- File formats other than MP3 (e.g. MPEG 1 LAYER 2 file) cannot be played.

#### Cannot record

- Confirm that the USB flash drive has open space.
- Confirm that the USB flash drive is not locked.
- When record from an analog source, check the recording level setting (page 29).
- Correct recording might not be possible depending on the USB flash drive. If this occurs, change to a different USB flash drive. See the TEAC Global Site (<http://teac-global.com/>) for information about USB flash drives that our company has confirmed for operation with this unit.  
Recording to all USB flash drives using this unit is not guaranteed.

#### Monitored sound skips.

- When recording from a CD to a USB flash drive, the monitored sound might skip depending on the type of USB flash drive, but this will not affect the recorded data.

### MP3 files

#### Unknown characters are displayed on the display panel.

- This unit cannot display double-byte symbols and characters (such as Japanese and Chinese) correctly. MP3 file names must only be alphanumeric characters to be shown properly.

#### "No title", "No artist" or "No album" appears on the display.

- ID3 tag information for the music file is missing. Edit the title, artist and/or album information of the song on a PC using a suitable application.

**Since this device uses a microcontroller, external noise and other interference can cause the unit to malfunction. If this occurs, turn the power off and, after waiting for about one minute, restart operation.**

#### **Beware of condensation**

Condensation could occur if the unit is moved from a cold place to a warm place, it is used immediately after a cold room has been heated or it is otherwise exposed to a sudden temperature change. To prevent this, or if this occurs, let the unit sit for one or two hours at the new room temperature before using it.

## MP3 playback order

MP3 files on a CD or a USB flash drive can be stored in folders in the same way that files are managed on a computer. Moreover, multiple folders can be contained inside another folder.

**Here is an example of the file and folder structure of an MP3 disc or a USB flash drive, showing the order of the folders (001 "ROOT" to 005) and the playback order of the files (1 to 9).**

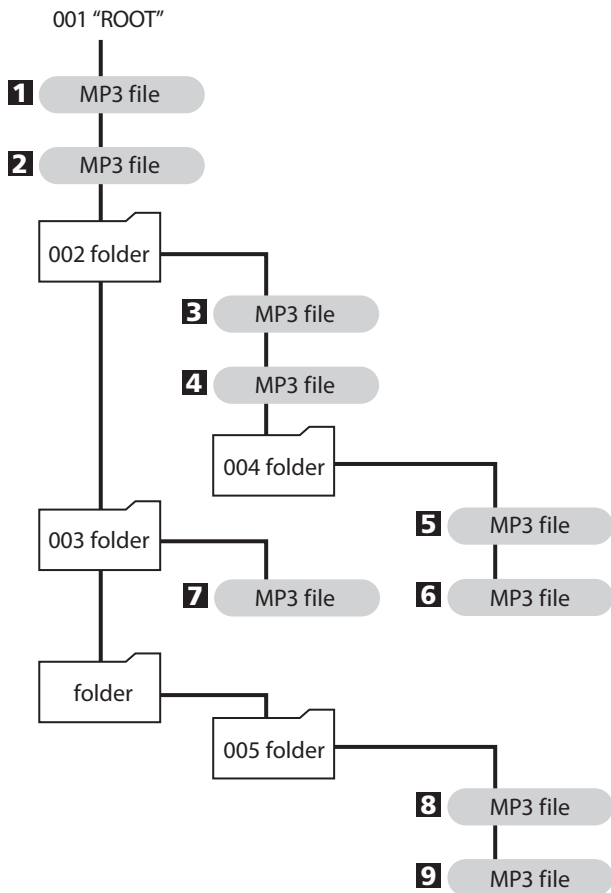

- Files will be shown and played back in the following order.  
USB: the order that MP3 files were copied  
CD: ASCII-code order

## Maintenance

If the surface of the unit gets dirty, wipe it with a soft cloth or use diluted mild liquid soap. Allow the surface of the unit to dry completely before using.

⚠ For safety, disconnect the power cord from the outlet before cleaning.

- Never spray liquid directly on this unit.
- Do not use thinner or alcohol as they could damage the surface of the unit.

### Cleaning the cassette deck

A dirty head can cause poor sound quality or the sound to skip. Dirt on the tape tracking roller might catch the tape. Clean the head, pinch roller, and capstan with a cotton applicator dampened with a commercially-available cleaning solution about every ten hours of use.

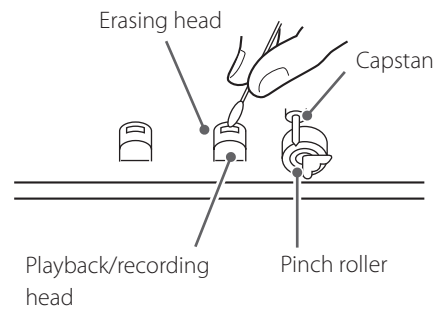

- Do not put a cassette tape in the cassette holder of the unit until the cleaning solution on the head dries.

# Specifications

## CD Player

Compatible discs	CD/CD-R/CD-RW (12 cm/8 cm)
Disc formats	
Audio CD	CD-DA
Data CD	ISO 9660 Level 1/2
Playable formats	
CD-DA	
Sampling frequency	44.1 kHz
Quantization bit depth	16-bit
Number of channels	2
MP3	
Audio modes	STEREO/JOINT STEREO/DUAL CHANNEL/MONO
Sampling frequency	16 kHz – 48 kHz
Bit rate	8 kbps – 320 kbps*
Frequency response	20 Hz – 20 kHz $\pm 2$ dB
Total harmonic distortion	0.02% or less (1 kHz)
Signal-to-noise ratio (S/N)	87 dB or more (IHF-A)
Line output (RCA)	Maximum output level +6 dBV (2.0 V) (load impedance of 50 k $\Omega$ or more)

\*DRM (Digital Rights Management) is not supported.

## Cassette tape player

Track system	4-track, 2-channel stereo
Heads	Record/playback $\times 1$ , erase $\times 1$
Type of tape	C-10 to C-90 cassette
Tape speed	4.76 cm/sec.
Motor	DC servo motor $\times 1$
Pitch control	$\pm 10\%$ (playback only)
Wow and flutter	0.25% (W. RMS)
Frequency response (overall)	50 Hz – 12.5 kHz $\pm 4$ dB, chrome 50 Hz – 12.5 kHz $\pm 4$ dB, normal
Signal-to-noise ratio (overall)	59 dB (Maximum recording level input, A-weighted)
Rewinding time	Approx. 120 sec. (with C-60)
Line input (RCA)	Nominal input level $-4.5$ dBu (0.46 V) (input impedance of 50 k $\Omega$ or more)
Line output (RCA)	Nominal output level $-4.5$ dBu (0.46 V) (load impedance of 50 k $\Omega$ or more)

## USB

Interface	USB 1.1 FULL SPEED (12 Mbps)
Connector	USB A port
Playback	
Frequency response	20 Hz – 20,000 Hz ( $\pm 2$ dB)
Signal-to-noise ratio	85 dB or more
Format	MP3
Sampling frequency	16 kHz – 48 kHz
Playback bit rate	8 kbps – 320 kbps
Line output (RCA)	Maximum output level +6 dBV (2.0 V) (load impedance of 50 k $\Omega$ or more)
Recording	
Frequency response	
CD $\rightarrow$ USB	20 Hz – 15 kHz ( $\pm 3$ dB)
LINE $\rightarrow$ USB	100 Hz – 15 kHz ( $\pm 3$ dB)
Signal-to-noise ratio	85 dB or more
Format	MP3
Sampling frequency	44.1 kHz
Record bit rate	128 kbps
Line input (RCA)	Nominal input level $-4.5$ dBu (0.46 V) (input impedance of 50 k $\Omega$ or more)

## Headphones

Headphone output connector	Standard stereo jack
Rated output	10 mW + 10 mW (CD monitoring, THD+N 0.1%, 32 $\Omega$ )

## General

Power requirement	
Model for Europe	AC 230 V, 50 Hz
Model for USA/Canada	AC 120 V, 60 Hz
Power consumption	13 W
Dimensions (W $\times$ H $\times$ D)	483 $\times$ 138.5 $\times$ 290 mm (19" $\times$ 5.5" $\times$ 11.4") (including protrusions)
Weight (Net)	6.0 kg (13.2 lb)
Operating temperature	+5°C to +35°C

## Included Accessories

Remote control (RC-1329)	$\times 1$
Batteries (AAA) for remote control	$\times 2$
Rackmount screw kit	$\times 1$
Owner's manual (this document, including warranty)	$\times 1$



## Dimensional drawings

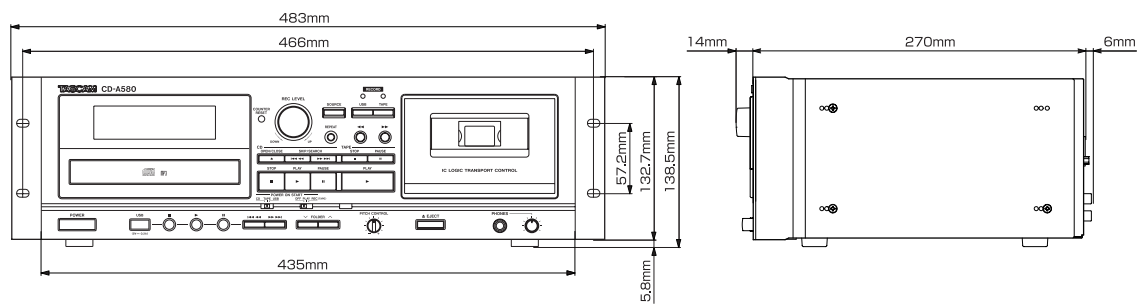

- Design and specifications are subject to change without notice.
- Weight and dimensions are approximate.
- Illustrations may differ slightly from production models.



## WARRANTY

### < In the United States >

This warranty gives you specific legal rights and you may also have other rights which vary from state to state. This warranty is only valid within the country the unit was originally purchased.

#### WHAT IS AND IS NOT COVERED

Except as specified below, this warranty covers all defects in materials and workmanship in this product. The following are not covered by the warranty:

1. **Damage to or deterioration of the external cabinet.**
2. **Damages resulting from accident, misuse, abuse or neglect.**
3. **Damage resulting from failure to perform basic daily maintenance and/or calibration or otherwise resulting from failure to follow instructions contained in your owner's manual.**
4. **Damage occurring during shipment of the product. (Claims must be presented to the carrier)**
5. **Damage resulting from repair or attempted repair by anyone other than TEAC or an authorized TASCAM service station.**
6. **Damage resulting from causes other than product defects, including lack of technical skill, competence, or experience of the user.**
7. **Damage to any unit which has been altered or on which the serial number has been defaced, modified or is missing.**

#### WHO MAY ENFORCE THE WARRANTY

This warranty may be enforced only by the original purchaser. This warranty is not valid if the product was purchased through an unauthorized dealer.

#### LENGTH OF WARRANTY

All parts except heads and disk drives are warranted for one (1) year from the date of original purchase. Heads and disk drives are warranted to ninety (90) days from date of original purchase. Labor is warranted for ninety (90) days from date of original purchase.

### WHAT WE WILL PAY FOR

We will pay all labor and material expenses for items covered by the warranty. Payment of shipping charges is discussed in the next section of this warranty.

#### HOW YOU CAN GET WARRANTY SERVICE

Your unit must be serviced by an authorized TASCAM service station in the United States. (This warranty is not enforceable outside the U.S.) If you are unable to locate an authorized TASCAM service station in your area, please contact us. We either will refer you to an authorized service station or instruct you to return the unit to the factory. Whenever warranty service is required, you must present a copy of the original dated sales receipt from an Authorized TASCAM Dealer.

You must pay any shipping charges if it is necessary to ship the product to service. However, if the necessary repairs are covered by the warranty, we will pay return surface shipping charges to any destination within the United States.

#### LIMITATION OF IMPLIED WARRANTIES

Any implied warranties, INCLUDING WARRANTIES OF MERCHANTABILITY AND FITNESS FOR A PARTICULAR PURPOSE, are limited in duration to the length of this warranty.

#### EXCLUSION OF DAMAGES

TEAC's liability for any defective product is limited to repair or replacement of the product, at TEAC's option. TEAC shall not be liable for:

1. **Damages based upon inconvenience, loss of use of the product, loss of time interrupted operation or commercial loss; or**
2. **Any other damages, whether incidental, consequential or otherwise.**

Some states do not allow limitations on how long an implied warranty lasts and/or do not allow the exclusion or limitation of incidental or consequential damages, so the above limitations and exclusions may not apply to you.

#### To locate an Authorized Service Center in Your Area

CALL 1-800-447-8322

### < Europe >

This product is subject to the legal warranty regulations of the country of purchase. In case of a defect or a problem, please contact the dealer where you bought the product.

Ce produit est sujet aux réglementations concernant la garantie légale dans le pays d'achat. En cas de défaut ou de problème, veuillez contacter le revendeur chez qui vous avez acheté le produit.

Dieses Gerät unterliegt den gesetzlichen Gewährleistungsbestimmungen des Landes, in dem es erworben wurde. Bitte wenden Sie sich im Gewährleistungsfall an den Händler, bei dem sie das Gerät erworben haben.

Questo apparecchio è conforme alle norme sulla garanzia vigenti nel rispettivo Paese in cui esso è stato acquistato. Si prega di rivolgersi al proprio commerciante, presso il quale è stato acquistato l'apparecchio, nel caso in cui si voglia richiedere una prestazione in garanzia.

Las condiciones de garantía de este aparato están sujetas a las disposiciones legales sobre garantía del país en el que ha sido adquirido. En caso de garantía, debe dirigirse al establecimiento donde adquirió el aparato.

### < In other countries/areas >

This warranty gives you specific legal rights, and you may also have other rights that vary by country, state or province.

If you have a warranty claim or request, please contact the dealer where you bought the product.

该保证书赋予了顾客特定的合法权利，并且因国家、州或省等地域的不同，顾客可能拥有其他权利。如需申请或要求保修，请与购买本产品的销售店进行联系。

If you require repair services for your TASCAM equipment, please contact the dealer where the product was purchased from or the TASCAM Distributor in your country. A list of TASCAM Distributors can be found on our website at: <http://teac-global.com/>

# TASCAM

## TEAC CORPORATION

Phone: +81-42-356-9143

1-47 Ochiai, Tama-shi, Tokyo 206-8530 Japan

<https://tascam.jp/jp/>

## TEAC AMERICA, INC.

Phone: +1-323-726-0303

1834 Gage Road, Montebello, California 90640 USA

<http://tascam.com/>

## TEAC MEXICO, S.A. de C.V.

Phone: +52-55-5010-6000

Río Churubusco 364, Colonia Del Carmen, Delegación Coyoacán, CP 04100, México DF, México

<http://teacmexico.net/>

## TEAC UK Ltd.

Phone: +44-8451-302511

2 Huxley Road, Surrey Research Park, Guildford, GU2 7RE, United Kingdom

<http://tascam.eu/>

## TEAC EUROPE GmbH

Phone: +49-611-71580

Bahnstrasse 12, 65205 Wiesbaden-Erbenheim, Germany

<http://tascam.eu/>

## TEAC SALES & TRADING(SHENZHEN) CO., LTD

Phone: +86-755-88311561~2

Room 817, Block A, Hailrun Complex, 6021 Shennan Blvd., Futian District, Shenzhen 518040, China

<http://tascam.cn/>

Printed in China

## WARRANTY

Model/Modèle/Modell  
Modello/Modelo/型号

**CD-A580**

Owner's name/Nom du possesseur/Name des Eigentümers  
Nome del proprietario/Nombre del propietario/顾客姓名

Serial No./No de Série/Seriennummer  
Numero di serie/Número de serie/序列号

Address/Adresse/Adresse  
Indirizzo/Dirección/顾客地址

Date of purchase/Date de l'achat/Datum des Kaufs  
Data dell'acquisto/Fecha de compra/购买日期

Dealer name/Nom du détaillant/Name des Händlers  
Nome del commerciante/Nombre del establecimiento/销售店名

**TASCAM**  
<http://teac-global.com/>

Dealer's address/Adresse du détaillant/Adresse des Händlers  
Indirizzo del commerciante/Dirección del establecimiento/销售店地址

**Sample**