



**MB 800  
OWNER'S MANUAL**

# MB 800

## Congratulations!

Your purchase of a new Gallien-Krueger MB Series amplifier is surely the result of much careful consideration on your part. For our part, we at Gallien-Krueger are pleased that you chose us, and are determined that you will be a satisfied customer. In choosing a MB Series amplifier, you now own an amplifier with many unique features which will allow you to create your own distinct sound.

To get the most out of your new purchase, please take a few minutes to read through this manual. If you are in a hurry, we suggest you at least read through the Quick Start section before setting up your new rig. This will help get you started and give you a few quick tips, but is not a substitute for reading the rest of the manual.

Your amplifier should have come with the following items, please check the contents of the box to ensure that you have everything.

### Included with your MB 800 Amplifier:

Power cord	1
Owner's manual	1
Warranty card (U.S. only)	1
Safety instructions sheet	1
One button foot switch	1

If your MB Series amplifier did not come with all the items listed, or if you encounter problems while setting up your new equipment, please contact your local dealer or GK as soon as possible.

Gallien-Krueger, Inc.  
2234 Industrial Drive  
Stockton, CA 95206  
phone: (209) 234-7300  
fax: (209) 234-8420  
internet: [www.gallien-krueger.com](http://www.gallien-krueger.com)  
email: [info@gallien.com](mailto:info@gallien.com)

**We wish you a lifetime of good playing and remember to always have fun!**



### GK Philosophy

I have never seen the point in doing things the way others have done them. I also have not been very interested in following the latest fad. I'm a Stanford educated engineer who worked my way through school as a musician. Like all musicians, I have lugged amplifiers up stairways and into car trunks, always wondering why these things had to be so heavy, bulky, and hard to handle.

As the principal innovator at GK, our products reflect my attitudes and life experiences. I don't model my designs after other manufacturers' products. Instead, I believe new and old problems are best solved with new solutions. Having taken our own path, GK products enjoy a unique, unmatched sound, allowing you every opportunity to make an original statement.

Having supported my products for over thirty years, I have learned from the story they tell. Gallien-Krueger is a reflection of that story, and has a commitment to support that legacy. Just as the products I created over thirty five years ago are still telling their story, the products we create today will be talking to us tomorrow.

We'll be listening,

A handwritten signature in black ink that reads "Robert Gallien". The signature is written in a cursive, flowing style.

**Robert Gallien  
Founder and President**

# MB 800

## Table Of Contents

Safety Information _____	4
Quick Start _____	5
Front Panel Features _____	6
Rear Panel Features/Sample Settings _____	7
Sound Tips _____	8
Installation and Maintenance _____	9
Tech Talk _____	10
Specifications _____	11

\*All Features and specifications are subject to change without notice





Please read the Safety Information section on page 4 and installation instructions on page 9 before continuing.

Gallien-Krueger  
2234 Industrial Drive  
Stockton, CA 95206  
phone: 209.234.7300  
fax: 209.234.8420

email: [info@gallien-krueger.com](mailto:info@gallien-krueger.com)  
internet: [www.gallien-krueger.com](http://www.gallien-krueger.com)

### Warning!

**This amplifier is capable of producing high sound pressure levels. Continued exposure to high SPL's can cause damage to your hearing. Always set the volume at a safe listening level or use hearing protection if the unit is operated at higher levels.**

	<b>CAUTION</b> RISK OF ELECTRIC SHOCK DO NOT OPEN	
<b>CAUTION:</b> TO REDUCE THE RISK OF ELECTRIC SHOCK, DO NOT REMOVE TOP COVER. NO USER-SERVICEABLE PARTS INSIDE. REFER SERVICING TO QUALIFIED SERVICE PERSONNEL.		
	The lightning flash with arrow head symbol, within the equilateral triangle, is intended to alert the user to the presence of uninsulated "dangerous voltage" within the product enclosure that may be of sufficient magnitude to constitute a risk of electric shock to persons	
The exclamation point within an equilateral triangle, is intended to alert the user to the presence of important operating and maintenance (servicing) instructions in the literature accompanying the appliance.		
<b>WARNING:</b> TO REDUCE THE RISK OF FIRE OR ELECTRIC SHOCK, DO NOT EXPOSE THIS APPLIANCE TO RAIN OR MOISTURE		
<b>CAUTION:</b> TO PREVENT ELECTRIC SHOCK, MATCH WIDE BLADE OF PLUG TO WIDE SLOT, FULLY INSERTED.		
<b>ATTENTION:</b> POUR EVITER LES CHOCS ELECTRIQUES, INTRODUIRE LA LAME LA PLUS LARGE DE LA FICHE DANS LA BORNE CORRESPONDANTE DE LA PRISE ET POUSSER JUSQU'AU FOND.		

**Safety Information**

Please read all enclosed safety precautions before connecting or operating this product.

**Verify Line Voltage and Amperage**

Your amplifier has been factory configured for use with the specific line voltage for your location only. For example, units set to operate within countries that supply 100-120 volt electrical service are not compatible with 230-240 volt systems used in other countries.

**100-120 Volt/60Hz 15A circuit for USA and Canada.**

**220-240 Volt/(50/60Hz) 10A circuit for UK and Australia.**

**220-240 Volt/(50/60Hz) 10 A circuit for Europe.**

**100-120 Volt/50Hz 15A circuit for Japan.**

**220-240 Volt/50Hz 10A circuit for Korea.**

**Proper AC circuit for all other countries.**

Connecting the amplifier to a line with specifications other than indicated above can create safety and fire hazard, and may damage the amplifier. If you have any questions about the voltage requirements for your specific model, or about the line voltage in your area, contact your dealer before plugging the unit into a wall outlet.

**Verify AC Circuit Capacity Before Use:** The high power output of your amplifier may require heavy current draw under full-load conditions. To insure proper performance and avoid potential safety hazards, we recommend connection to line circuits with amperage specified “as above”. Connecting to the same circuit used by other heavy power devices, such as high wattage lights, may cause circuit breakers to trip. It is always a good idea to avoid using any audio equipment on the same AC circuit as equipment with motors, such as air conditioners or refrigerators. This will lessen the possibility of power variation and electrical start-up noise affecting your sound.

**Please refer to page 9 for more instructions concerning installation.**

**AC Power Cord:** To avoid safety hazards, use only the power cord supplied with your unit. If a replacement cord is needed, make certain to use a standard IEC compliant cord. Damaged power cords should be replaced immediately. When setting up, make certain that the AC plug is easily accessible. If you do not intend to use the amplifier for a considerable length of time, disconnect the plug from the AC Mains Socket. Do not use an extension cord.

**Earth Grounding Connection:** To prevent electric shock, do not remove the grounding plug on the power cord, or use any plug or extension cord that does not have a grounding plug provided. Make certain that the AC outlet is properly grounded as well. Do not use an adapter plug with this product.

**Do Not Open the Amplifier Enclosure:** There are no user serviceable parts inside this product. Opening the amplifier enclosure may present a shock hazard. Modification to the product will void your warranty. If liquid enters the unit, or any metal object such as a paper clip accidentally falls inside the enclosure, disconnect the unit from the AC power source immediately and consult an authorized service station.

**Setup:** To insure proper operation and to avoid potential safety hazards, place the unit on a firm, level surface. Do not plug or unplug the instrument or speaker cable while the amplifier power is on.

**Heat & Ventilation:** Make sure there is space provided for proper ventilation. Avoid using in extremely hot or cold locations and areas that are exposed to direct sunlight or near heating equipment. Avoid using in moist or high humidity areas.

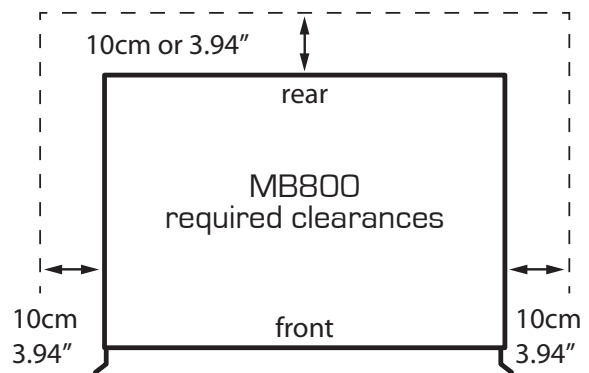

**NEVER BLOCK THE FAN VENT HOLES ON THE SIDES OF THE UNIT!**

## Quick Start

The **MB 800** amplifier is designed to be simple to operate. All controls have a well defined purpose. These directions will take you through the basics and give you a good start for setting up your sound.

**1. Plug it in:** Set the power switch to Off and connect the supplied power cord, from the amplifier AC receptacle, to an AC power outlet of proper voltage and power rating (see safety information on page 4 for details).

**2. Connect your cabinets:** Connect your speaker cabinets to the amplifier outputs marked SPEAKER using a standard two conductor speakon cable or Gallien-Krueger four conductor speaker cable. Be sure not to exceed the recommended speaker load as noted below.

**Maximum Recommended Speaker Loads:** One 4 Ohm, or two 8 Ohm cabinets.

**3. Initial front panel control settings:** Set all EQ controls and contour knob to 12 o'clock. Set the Gain A, Gain B, Level B and Master control to the full counterclockwise position. Upon power up, the Gain A control is the default input gain adjustment and should be lit blue. If the Gain A knob is not lit, push it until a slight click is felt and the knob indicator is lit blue.

**4. Plug in your bass:** Using an instrument (shielded) cable, connect your bass to the Input jack and press the power switch to the on (in) position. If you have active tone controls on your bass, turn all of the controls to the middle or flat position and turn the volume all the way up. If you have conventional, passive tone controls, turn all tone and volume controls all the way up.

**5. Level and Master Volume settings:** Set the Master control to 12 o'clock. Turn the Gain A knob up as you play until the desired output volume is reached. If the input clip indicator (the ring surrounding the -10 pad switch) flashes more than occasionally or distortion is audible, set the -10dB pad switch to the up position and increase the Gain A level until the desired output volume is reached. If the clip indicator continues to light often, it may be necessary to decrease the volume on your instrument.

\*For high volume applications, it may be necessary to increase the Master control beyond

the 12 o'clock setting.

**6. Gain B/Level B:** Pushing the Gain B knob (also selectable from the provided footswitch) activates the Gain B input and Level B controls. Once activated (indicated by the Gain B and Level B knob lit blue), bring the Level B control to the 12 o'clock position and increase the Gain B level until the desired volume is heard. Higher Gain B settings will produce more overdriven/distorted tones while lower settings will maintain a clearer, less overdriven tone. When used in conjunction with the Level B control, the desired overdrive and output volume can be set relative to the Gain A level. You should be hearing your bass quite well through both the Gain A and Gain B channels. At this point you can experiment with different EQ and Contour settings. A sample setting can also be found on page 7.

\*The Limiter is active upon power up (Master is lit blue) and is recommended for high volume applications.

# MB 800

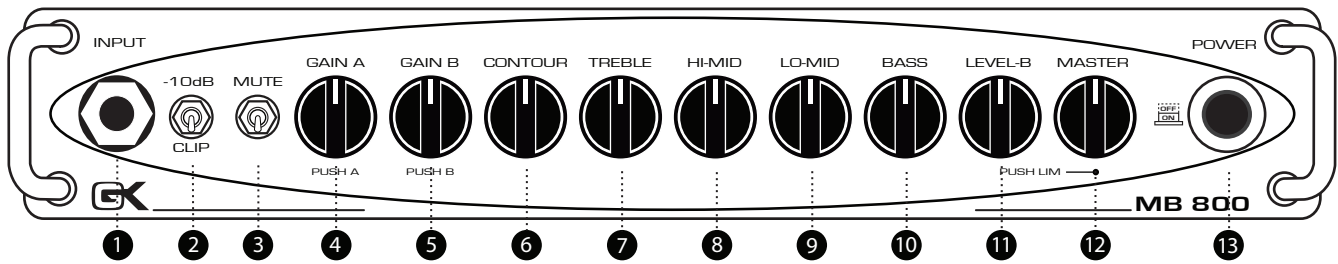

## Front Panel Features

- 1 Input:** A standard 1/4" input jack to connect active or passive basses using a shielded cable.
- 2 -10 dB Pad/Clip indicator:** This is generally set to the down position except in cases where the clip indicator (the ring surrounding the -10dB switch) flashes more than occasionally. This indicates the input is being overdriven. If the -10dB pad is active (up position) and the clip indicator still flashes frequently, reduce the volume on your bass.
- 3 Mute:** Set this switch to on (up) position when tuning or unplugging your instrument. The input signal will be sent to the tuner output located on the rear panel but no signal will be sent to the speaker or XLR outputs. When the mute is active, the ring surrounding the mute switch will be lit red.
- 4 Gain A (push):** Sets the preamp gain after the input stage and is used in conjunction with the input pad to optimize the input signal level sent through the preamp. Activated by default upon power up and when the Gain A knob is pressed as well as from the provided footswitch. The Gain A knob is lit blue when active.
- 5 Gain B (push):** Allows an additional preamp gain level to be set independent of Gain A. When used in conjunction with the Level B control, the desired overdrive and output volume can be set relative to the Gain A level. Activated by pressing the Gain B knob or by the included footswitch. Gain B remains active and is lit blue until Gain A is selected.
- 6 Contour:** The contour control decreases the mid-range frequencies while boosting low and high frequencies.
- 7 Treble:** Boost and cut at 7 kHz +14 dB shelving type. Use this control to add or remove edge and definition.
- 8 Hi-Mid:** Boost and cut at 1 kHz +6 dB. A "Q Optimized," band pass type, this works on lower string harmonics and effects the punch of your sound.
- 9 Lo-Mid:** Boost and cut at 250Hz +6dB/-10 dB. A "Q optimized" band pass type, this works for the main body of your sound.
- 10 Bass:** Boost and cut a 60Hz +10 dB, shelving type. This is used to control the low end push.
- 11 Level B:** Activated and is lit blue in conjunction with Gain B. Sets the volume when Gain B is selected.
- 12 Master (push):** Controls the overall output of the MB800. In addition, pushing the master knob engages/disengages the limiter function. Upon powering up the amplifier, the Master knob indicator is lit blue indicating the limiter is engaged. When the master knob is pushed the limiter function is disengaged and the knob indicator changes to white. If power amp clipping occurs, the knob indicator will flash red indicating that the limiter function should be engaged. The limiter function prevents the power amp from distorting and is recommended during high volume applications.  
**Limiter (Master knob pushed/engaged):** When this button is engaged it prevents the power amp from distorting. It is recommended that this feature is used for during high volume applications.
- 13 Power Switch:** Turns the amplifier on and off. In the on position, the ring surrounding the button will light red during power up then changes to blue, indicating the amp is ready for normal operation. Should the amp experience a fault (over heat or over current) the amp will mute and the ring will light red until the condition is corrected. This LED turns off when the power is switched off. This turns the amp off but it does not completely disconnect the power from the AC mains.



# MB 800

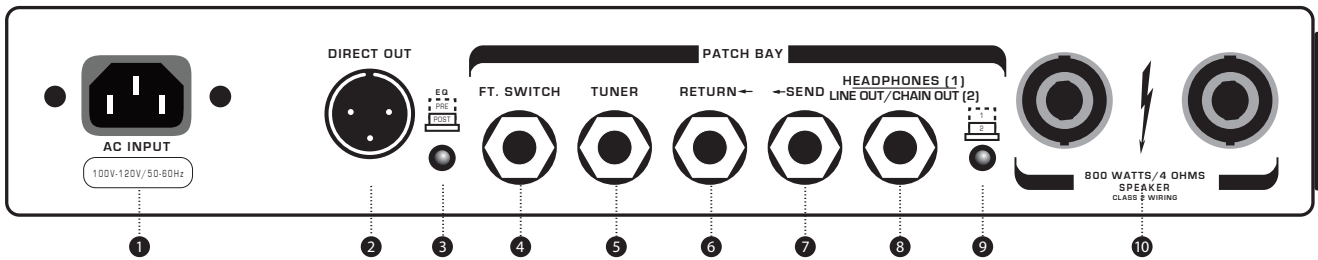

## Rear Panel Features

- 1 **AC Receptacle:** The detachable power cord plugs in here.
- 2 **Balanced Direct Out:** This electronically balanced output allows a direct connection to a P.A. system.
- 3 **Pre/Post EQ Button:** This button switches the direct out signal to be before or after the EQ.
- 4 **Foot switch Input:** A foot switch is provided to select Gain A or Gain B modes.
- 5 **Tuner Output:** This output comes directly off of the input stage and can be patched to a tuner using a shielded patch cord. This output is unaffected by the tuning mute feature.
- 6 **Return:** This input allows the signal from outboard effects devices to be inserted before the boost section.
- 7 **Send:** This output allows signal from the preamp to be fed to outboard effects devices from a point after the EQ section.
- 8 **Headphone/Line out/Chain out:** This output allows the user to send a direct (unbalanced) line out to devices with unbalanced inputs such as

personal multitrack recorders. This connection requires a shielded patch cord. The Chain out allows the user to connect directly to a GK MBP powered extension cabinet. This connection is made with a balanced, tip, ring, sleeve to male XLR cable.

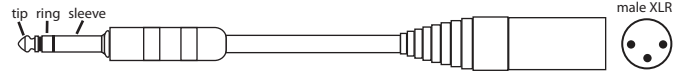

Unswitched, this headphone jack can be used to monitor your playing with headphones.

- 9 **Headphone/Line out/Chain Out switch:** This switch toggles the output from headphone to line out/chain out.
- 10 **Speaker:** Power amp output to speaker cabinet. Speaker outputs are high current, twist-lock Speakon connectors.

## Sound Tips

The MB 800 has several unique features which, if used properly, will help you obtain the sound you have been searching for.

**Discreet Preamp:** The MB800 features a completely discreet FET (field effect transistor) driven preamp. The same FET technology used to create the legendary boost (G.I.V.E.) circuit found in all GK amplifiers for over 30 years is used in every stage of the MB800 preamp. Using FET devices with the gate biased in a way that emphasizes the optimum harmonic content of the signal to drive the GK four band active EQ, Contour and Gain allows the MB800 to transition seamlessly from a full, warm, clean tone to full on GK growl.

**The Equalizer:** The Equalizer is used to fine tune your sound. When adjusting making adjustments, do it just a little at a time. These are active circuits and small changes can make a big difference in your sound. With a little experimentation you will find that this equalizer is very easy to use and provides you with a large variety of great sounds unique to GK.

**Contour:** Increasing the Contour level will scoop out midrange frequencies while boosting the highs and lows. The sound, once again, is unique to GK and available on any other bass amp. Lower contour settings are recommended for midrange clarity at higher playing levels.

**Gain B/ Level B:** Turning up the Gain B control will add a little growl to your tone by adding a small amount of even order harmonic distortion. This is an unmistakable GK trade mark sound that you will surely grow to appreciate. Raising the Boost while lowering Level B will add more growl while keeping the sound level the same. You can use Level B to increase or lower the overall output volume when switching the Gain B on via the front panel or from the included foot switch. With either

Gain A or Gain B, the cleanest sound is obtained with master volume settings at approximately 3 o'clock.

**Direct Out:** The MB Series provides a low noise, high quality balanced direct output for connection to PA and recording consoles. With the Pre/Post EQ switch set to "Pre" (Out), the direct output signal is fed directly from the input stage providing a low noise output superior to external direct boxes and impedance transformers. In the "Pre" position, the direct output signal is only effected by the Input Volume, -10db Pad and Mute. This allows you to adjust your tone and volume on stage without changing the Direct Output signal level and confusing your sound man. Changing the Pre/Post EQ switch to "Post" (in), sends the "GK Sound" (EQ settings etc.) and preamp response to the Direct Out jack. This gives you complete control over the Direct Out's tone and volume.

**Limiter:** When the limiter is engaged it prevents the power amp from distorting. It is recommended that this feature is used during high volume situations.



**Installation:** To insure proper operation and to avoid potential safety hazards, place the unit on a firm, level surface.

**Ventilation:** Make certain that proper space is provided for ventilation. Never block the fan vent holes located on the sides of the amplifier. If the amplifier will be installed in a rack or other enclosed area, make sure that there is sufficient air movement within the enclosure to allow proper cooling. Consult your dealer for more information. Avoid installation in extremely hot or cold locations, and areas that are exposed to direct sunlight, or near heating equipment. Avoid moist or humid locations.

Remember, power amplifiers generate heat. The ventilation slots on the enclosure are specifically designed to remove this heat. Blocking or placing other electronic equipment near the heat dissipation system may possibly affect the long-term reliability of both your amplifier and the other equipment.

**Moving the Unit:** Before moving the unit, be certain to disconnect any interconnection cords with other components, and make sure that you disconnect the unit from the AC outlet.

**Cleaning:** When the unit gets dirty, clean only with a dry cloth. Never use benzene, thinner, alcohol, or other volatile cleaning agents. Do not use abrasive cleaners, as they may damage the finish of metal parts. Avoid spraying insecticides near the unit.

**Maintenance:** Your new amplifier is rugged. It was built to give you a lifetime of trouble free operation, if it is operated in accordance with the instructions contained in this manual. The only

maintenance required is cleaning. If you are going to move your amplifier around frequently, we recommend a road case to protect it from scratches and road wear.

**Packaging:** The carton and packing materials used in shipping your new amplifier were specifically designed to cushion it from the shocks and vibration that occur during transport. We suggest that you save the carton and packing materials for use in shipping, in the event you move, or the amplifier needs repair.

## Tech Talk

The MB800 features a completely discreet FET (field effect transistor) driven preamp. The same FET technology used to create the legendary boost (G.I.V.E.) circuit found in all GK amplifiers for over 30 years is used in every stage of the MB800 preamp. Using FET devices with the gate biased in a way that emphasizes the optimum harmonic content to drive the GK four band active EQ, Contour and Gain allows the MB800 to transition seamlessly from a full, warm, clean tone to full on GK growl.

### Characteristics of the MB 800:

The MB 800 is a flexible, state-of-the-art amplifier designed to deliver maximum performance while remaining small, lightweight and simple to operate. This is accomplished through a few, very important features:

- **Class D power supply and power amp.**
- **Four, Bass specific bands of active equalization for precise tone control.**
- **Balanced direct output eliminates the need for a direct box.**
- **Continuously variable fan cooling.**

**Equalization:** Standard tone controls and graphic equalizers give you plenty of variation, but they don't provide what the instrument really needs. The fact is, graphic equalizers are intended for room equalization. The equalization in Gallien-Krueger amplifiers reflects 40 years of continuous development and refinement. The GK equalizer is unique to the industry, it's not just a normal four band equalizer, each section is a special circuit optimized to perform a bass specific job in its range of operation. These sections are wired in series, so they add to one another creating a tremendously flexible equalizer, that sounds natural at any setting. Now it is possible to obtain the sound you desire.

**Contour:** The Contour is used to completely revoice the amplifier. The Contour control tunes between two different shaping circuits, with greatly different responses. With the control all the way up, the low end is slightly boosted, the mids are dropped and the high end is pushed up. This is only found in GK amplifiers.

**“G.I.V.E.” Technology:** As in all GK pre-amps, the MB Series pre-amp incorporates what we call G.I.V.E (Gate Induced Valve Effect) Technology. We use field effect devices with the gate biased in a way that emphasizes the optimum harmonic content of the signal. Working in concert with our unique four band active equalizer, and three stage voicing filter section, G.I.V.E. technology produces a consistently pleasing bass tone.

**Cool Running = Reliability:** To cool the amp when its being driven hard, we've designed a temperature sensitive fan cooling system. When the amp is under a light load, the fan is off or running at a low speed, reducing fan noise. As the amp works harder, the fan speed increases to keep everything cool.

**Smart Protection Circuitry:** The MB Series protection circuitry constantly monitors for unsafe operating conditions such as short circuits, miss-wired speaker cables, blown speakers, improper ventilation, and incorrect speaker configurations. In addition, protection is provided during power up/down. If the MB Series senses any unsafe operating conditions, the output signal is immediately muted and the power light changes from blue to red. The amplifier will remain muted until the fault is removed. If the protection circuit activates while playing, turn the amplifier off and check the amplifier speaker output connections. Be sure that you are not exceeding the maximum recommend load described in this manual. If the problem persists, contact GK directly for technical advice.

**In Closing:** You should now have a thorough understanding of how your new MB Series amplifier works and what advantages it can offer you in getting “your” sound.

We thank you for reading the owner's manual and wish you the best of times! Please send us your comments via [www.gallien-krueger.com](http://www.gallien-krueger.com) or email us at [sales@gallien.com](mailto:sales@gallien.com).

# BLOCK DIAGRAM

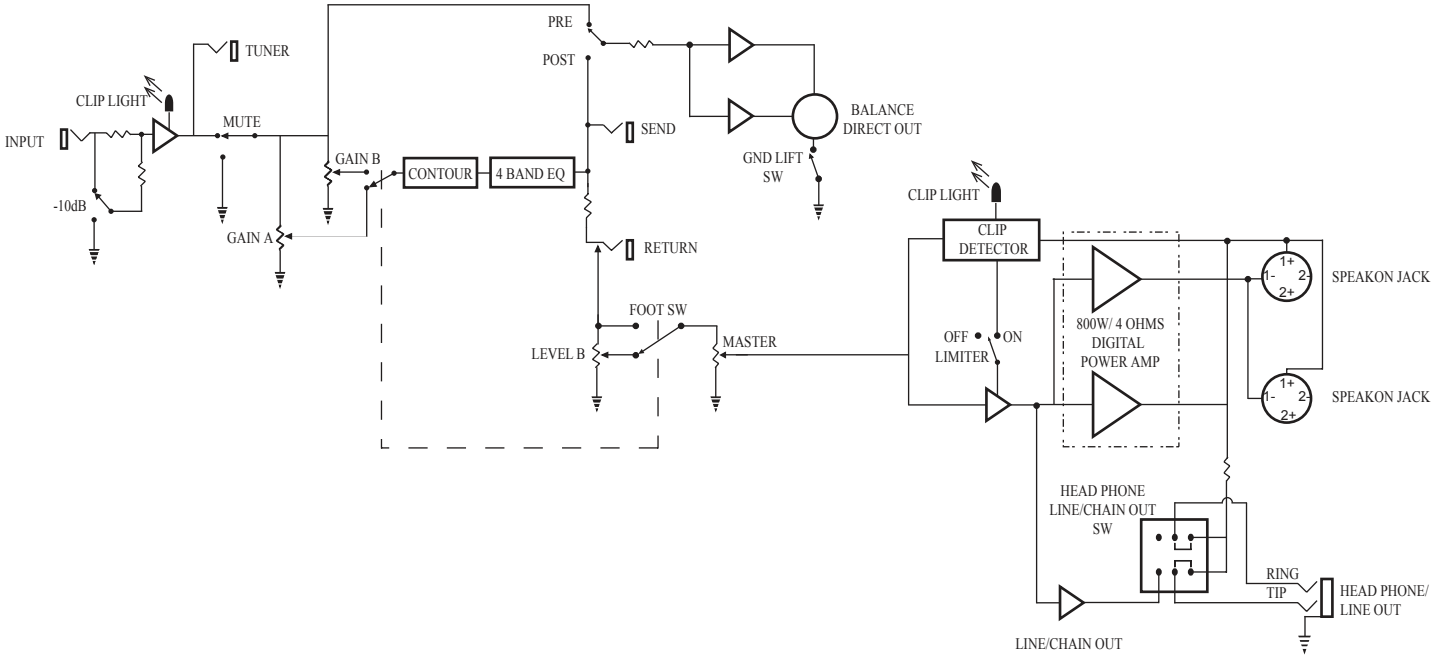

# SPECIFICATIONS

**Output Power:** 560W @ 8 Ohms  
800W @ 4 Ohms

**Input/Output Specs:**  
Maximum Input Level 0.6V Rms  
With -10dB pad 1.6V Rms  
Input Impedance 1M Ohms  
Send Output Impedance 220 Ohms  
Return Input Impedance 50K Ohms  
Tuner Output Impedance 10K Ohms  
Direct Output Impedance 500 Ohms

**Noise :** -90 dB reference to 800W/560W, "A" Weighted.

**Equalizer:**  
Bass +/-10dB @ 60Hz  
Lo-Mid +6dB/-10dB @ 250Hz  
Hi-Mid +6dB/-10dB @ 1KHz  
Treble +/-14dB @ 7KHz

**Voicing Filters:**  
Contour +2dB @ 50Hz/ -10dB @ 500Hz/  
+3dB @ 7 KHz

**Amplifier Protection:**  
Full short circuit, thermal and RF protection.  
Stable into reactive and mismatch loads.  
Five second muted warm-up.

**Cooling:** Variable Speed Fan

**Dimensions (HxWxD):**  
1.75"[44.45mm] X 11"[279.4mm] X 9"[228.67mm]

**Weight:** 4.9 Lbs [2.23 kgs].

**Power requirements:** U.S.A./Canada 120V/60Hz.  
880W(full power), 110W(average power)  
Europe 230V/50Hz/60Hz  
880W(full power), 110W(average power)  
Japan 100V/50Hz  
880W(full power), 110W(average power)

LR110409  
 This device has been tested and found to comply with:  
CAN/CSA 60065-03 Safety Requirements.  
us UL std. No. 60065-2007 Safety Requirements.

 This device complies with Part 15 of the FCC Rules.  
Operation is subject to the following two conditions:  
(1) This device may not cause harmful interference, and  
(2) This device must accept any interference received,  
including interference that may cause undesired operation.  
Note: This equipment has been tested and found to  
comply with the limits for a Class B digital device, pursuant  
to part 15 of the FCC Rules.



MB 800  
Owners Manual  
Part # 160-0690-A1