



MB FUSION 800
OWNER'S MANUAL

MB FUSION 800

Congratulations!

Your purchase of a new Gallien-Krueger MB Fusion 800 amplifier is surely the result of much careful consideration on your part. For our part, we at Gallien-Krueger are pleased that you chose us, and are determined that you will be a satisfied customer. In choosing a MB Fusion 800 amplifier, you now own an amplifier with many unique features which will allow you to create your own distinct sound.

To get the most out of your new purchase, please take a few minutes to read through this manual. If you are in a hurry, we suggest you at least read through the Quick Start section before setting up your new rig. This will help get you started and give you a few quick tips, but is not a substitute for reading the rest of the manual.

Your amplifier should have come with the following items, please check the contents of the box to ensure that you have everything.

Included with your MB Fusion 800 amp:

Power cord	1
Owner's manual	1
Warranty card (U.S. only)	1
Safety instructions sheet	1
One button foot switch	1

If your MB Fusion 800 amplifier did not come with all the items listed, or if you encounter problems while setting up your new equipment, please contact your local dealer or GK as soon as possible.

Gallien-Krueger, Inc.

2234 Industrial Drive
Stockton, CA 95206
phone: (209) 234-7300
fax: (209) 234-8420
www.gallien.com
email: info@gallien.com

We wish you a lifetime of good playing and remember to always have fun!



GK Philosophy

I have never seen the point in doing things the way others have done them. I also have not been very interested in following the latest fad. I'm a Stanford educated engineer who worked my way through school as a musician. Like all musicians, I have lugged amplifiers up stairways and into car trunks, always wondering why these things had to be so heavy, bulky and hard to handle.

As the principal innovator at GK, our products reflect my attitudes and life experiences. I don't model my designs after other manufacturers' products. Instead, I believe new and old problems are best solved with new solutions. Having taken our own path, GK products enjoy a unique, unmatched sound, allowing you every opportunity to make an original statement.

Having supported my products for over forty years, I have learned from the story they tell. Gallien-Krueger is a reflection of that story, and has a commitment to support that legacy. Just as the products I created over forty years ago are still telling their story, the products we create today will be talking to us tomorrow.

We'll be listening,

Robert Gallien
Founder and President

MB FUSION 800

Table Of Contents

Safety Information _____	4
Quick Start/Tech Talk _____	5
Front Panel Controls _____	6
Rear Panel Features _____	7
Specifications _____	8

*All Features and specifications are subject to change without notice





Please read the Safety Information section on page 4 before continuing.

Gallien-Krueger
2234 Industrial Drive
Stockton, CA 95206
phone: 209.234.7300
fax: 209.234.8420

email: info@gallien.com
www.gallien.com

Warning!

This amplifier is capable of producing high sound pressure levels. Continued exposure to high SPL's can cause damage to your hearing. Always set the volume at a safe listening level or use hearing the volume at a safe listening level or use hearing

	CAUTION DO NOT OPEN RISK OF ELECTRIC SHOCK	
CAUTION: TO REDUCE THE RISK OF ELECTRIC SHOCK, DO NOT REMOVE TOP COVER. NO USER SERVICEABLE PARTS INSIDE. REFER ALL SERVICING TO QUALIFIED SERVICE PERSONNEL.		
	The lightning flash with arrow head symbol, within the equilateral triangle, is intended to alert the user to the presence of uninsulated "dangerous voltage" within the product enclosure that may be of sufficient magnitude to constitute a risk of electric shock to persons	
The exclamation point within an equilateral triangle, is intended to alert the user to the presence of important operating, servicing and maintenance instructions in the literature accompanying this appliance.		
WARNING: TO REDUCE THE RISK OF FIRE OR ELECTRIC SHOCK, DO NOT EXPOSE THIS APPLIANCE TO RAIN OR MOISTURE		
CAUTION: TO PREVENT ELECTRIC SHOCK, MATCH WIDE BLADE OF PLUG TO WIDE SLOT, FULLY INSERTED.		
ATTENTION: POUR EVITER LES CHOCS ELECTRIQUES, INTRODUIRE LA LAMELA PLUS LARGE DE LA FICHE DANS LA BORNE CORRESPONDANTE DE LA PRISE ET POUSSER JUSQU'AU FOND.		

Safety Information

Please read all enclosed safety precautions before connecting or operating this product.

Verify Line Voltage and Amperage: Your new amp has been factory configured for use with the specific line voltage for your location. Products using 100-120 volt power supplies are not compatible in locations wired for 200-240 volt operation and 200-240 volt units are not compatible in 100-120 volt locations.

120 Volt/60Hz 15A circuit for USA/Canada.
230 Volt/(50/60Hz) 10A circuit for UK/Australia.
230 Volt/(50/60Hz) 10A circuit for Europe.
100 Volt/50Hz 15A circuit for Japan.
220 Volt/50Hz 10A circuit for Korea.
Proper AC circuit for all other countries.

Connecting the amplifier to a line with specifications other than indicated above can create safety and fire hazard, and may damage the amplifier. If you have any questions about the voltage requirements for your specific model, or about the line voltage in your area, contact your dealer before plugging the unit into a wall outlet.

Verify AC Circuit Capacity Before Use: The high power output of your amplifier may require heavy current draw under full-load conditions. To insure proper performance and avoid potential safety hazards, we recommend connection to line circuits with amperage specified above. Connecting to the same circuit used by other heavy power devices, such as high wattage lights, may cause circuit breakers to trip. It is always a good idea to avoid using any audio equipment on the same AC circuit as equipment with motors, such as air conditioners or refrigerators. This will lessen the possibility of power variation and electrical start-up noise affecting your sound.

AC Power Cord: To avoid safety hazards, use only the power cord supplied with your unit. If a replacement cord is needed, make certain to use a standard IEC compliant cord. Damaged power cords should be replaced immediately. When setting up, make certain that the AC plug is easily accessible. If you do not intend to use the amplifier for a considerable length of time, disconnect the plug from the AC Mains Socket. Do not use an extension cord.

Earth Grounding Connection: To prevent electric shock, do not remove the grounding plug on the power cord, or use any plug or extension cord that

does not have a grounding plug provided. Make certain that the AC outlet is properly grounded as well. Do not use an adapter plug with this product.

Do Not Open the Amplifier Enclosure: There are no user serviceable parts inside this product. Opening the amplifier enclosure may present a shock hazard. Modification to the product will void your warranty. If liquid enters the unit, or any metal object such as a paper clip accidentally falls inside the enclosure, disconnect the unit from the AC power source immediately and consult an authorized service station.

Setup: To insure proper operation and to avoid potential safety hazards, place the unit on a firm, level surface. Do not plug or unplug the instrument or speaker cable while the amplifier power is on.

Heat & Ventilation: Make sure there is space provided for proper ventilation. There should be at least one centimeter (.4 inches) on top and nine centimeters (3.54 inches) clearance along the sides and rear of unit for proper ventilation. This also applies to rack mounting the unit. GK recommends using the **MB Fusion 800 Rack Kit** available from an authorized GK dealer or from our store at www.gallien.com.

Avoid using in extremely hot or cold locations and areas that are exposed to direct sunlight or near heating equipment. Avoid using in moist or high humidity areas.

Remember, power amplifiers generate heat. The ventilation slots on the enclosure are specifically designed to remove this heat. Blocking or placing other electronic equipment near the heat dissipation system may possibly affect the long term reliability of both your amplifier and the other equipment.

NEVER BLOCK THE FANS OR VENT HOLES ON THE SIDES OF THE UNIT!

Quick Start

These directions will take you through the basics and give you a good start for setting up your sound.

Connect your Speaker: Connect your speaker cabinets to the amplifier outputs marked SPEAKER using a standard two conductor speakon cable or Gallien-Krueger four conductor speaker cable. Be sure not to exceed the recommended speaker load as noted below.

Maximum Recommended Speaker Loads: One 4 Ohm, and one or two 8 Ohm cabinets.

Initial front panel control settings: Set all EQ controls and the contour knob to 12 o'clock. Set the Gain A, Gain B, Level B and Master controls to the full counter clockwise position. Disengage all voicing filter functions by pressing the contour, treble and bass knobs until they are lit white. Confirm that the Gain A and Limiter are active by pressing the Gain A and Master knob until they are lit blue. The -10db and mute switch should be in the off (down) position.

Plug in your bass: Using an instrument (shielded) cable, connect your bass to the input jack and press the power switch to the on (in) position. If you have active tone controls on your bass, turn all of the controls to the middle or flat position and turn the volume all the way up. If you have conventional, passive tone controls, turn all tone and volume controls all the way up.

Level and Master Volume settings: Set the Master control to 12 o'clock. Turn the Gain A knob up as you play until the desired output volume is reached. If distortion is audible due to input clipping, (or the ring surrounding the pad switch frequently flashes red) set the -10dB pad switch to up position and increase the Gain A level until the desired output volume is reached. Decrease the volume on your instrument if clipping persists. For high volume applications, it may be necessary to increase the Master control beyond the 12 o'clock setting.

Gain B/Level B: Pushing the Gain B knob (also selectable from the provided footswitch) activates the Gain B input and Level B controls. Once activated (indicated by the Gain B and Level B knob lit blue), bring the Level B control to the 12 o'clock position and increase the Gain B level until the desired volume is heard. Higher Gain B settings will produce more overdriven/distorted tones while lower settings will maintain a clearer, less overdriven tone. When used in conjunction with the Level B control, the desired overdrive and output volume can be set relative to the Gain A level. You should be hearing your bass quite well through both the Gain A and Gain B channels. At this point you can experiment with different EQ and Contour settings.

Tech Talk

Deep: The Deep switch extends the low frequency range of the amplifier to accommodate the extra low range of the B string on 5 and 6 string basses. Players of four string basses may also find desirable results with this filter as well.

Presence: The Presence control adds extra sparkle on the high end for better clarity and 'openness' in your tone. This is particularly useful when soloing or playing chords.

Limiter: When the limiter is engaged it prevents the power amp from distorting. The Limiter is active upon power up (Master is lit blue) and is recommended for high volume applications.

Active Equalization: The equalizer in GK amplifiers is unique and reflects over 40 years of continuous development and refinement. The active circuitry allows you to either boost or cut at a given frequency with greater integrity in signal reproduction. The treble is a shelving type control that boosts the high frequencies evenly. Respectively, the bass is a shelving control that evenly boosts the low frequencies. The high mid and low mid are peak (band pass) type controls with wide Q (bandwidth) patterns which are much more musical sounding.

Contour: The Contour adds a variable control and center frequency select for precise tone shaping. With the control at zero, the response is essentially 'flat' (as in no shaping). As the contour is increased, it scoops out the midrange. Additionally, it compensates to keep the overall volume level constant. With it's variable control, the Contour will accommodate everyone from the smooth finger style player to the aggressive slap player.

Gain and Master A/B: The Gain A/B settings determine the overall drive of the signal. Lower settings will allow for the cleanest sound, while higher settings will result in an overdriven signal as the tubes distort. For high volume applications where maximum headroom is desired, the Master A/B knobs should be set a 3 o'clock or higher.

Direct Out: The MB Fusion provides a low noise, high quality balanced direct output for connection to PA and recording consoles. With the Pre/Post EQ switch set to "Pre" (Out), the direct output signal is fed directly from the input stage. The direct output signal is only effected by the Input Volume, -10db Pad and Mute. This allows you to adjust your tone and volume on stage without changing the Direct Output signal. Changing the Pre/Post EQ switch to "Post" (In), sends the "GK Sound" (EQ settings etc.) and preamp response to the Direct out jack. This gives you complete control over the Direct out's tone and volume.

MB FUSION 800



Front Panel Features

- 1 Input:** A standard 1/4" input jack to connect active or passive basses using a shielded cable.
- 2 -10 dB Pad/Clip indicator:** This is generally set to the down position except in cases where distortion is audible due to input clipping or if the ring around the switch flashes red often. If the -10dB pad is active (up position) and input clipping is still audible, reduce the volume on your bass.
- 3 Mute:** Set this switch to on (up) position when tuning or unplugging your instrument. The input signal will be sent to the tuner output located on the rear panel but no signal will be sent to the speaker or XLR outputs. When the mute is active, the ring surrounding the mute switch will be lit red.
- 4 Gain A (push):** Sets the preamp gain after the input stage and is used in conjunction with the input pad to optimize the input signal level sent through the preamp. Activated by default upon power up and when the Gain A knob is pressed as well as from the provided footswitch. The Gain A knob is lit blue when active.
- 5 Gain B (push):** Allows an additional preamp gain level to be set independent of Gain A. When used in conjunction with the Level B control, the desired overdrive and output volume can be set relative to the Gain A level. Activated by pressing the Gain B knob or by the included footswitch. Gain B remains active and is lit blue until Gain A is selected.
- 6 Contour:** With the control at zero (full counter clockwise position), the response is considered "flat" (no tone shaping). As the Contour knob is turned clockwise mid frequencies are reduced and low and high frequencies are increased while maintaining uniform volume.
Push Contour: Pushing the Contour knob toggles the center frequency of the Contour circuit between 500Hz (knob lit white) and 800Hz (knob lit blue).
- 7 Treble (push):** (+10/-19dB @7 kHz) Boost and cut shelving EQ. Use this control to add or remove edge and definition.
Push Presence: (+4dB@10kHz) Adds extra sparkle on the high end for better clarity and openness in your tone. This is particularly useful when soloing or playing chords. Pushing the Treble knob toggles the Presence circuit off (knob lit white) and on (knob lit blue).
- 8 Hi-Mid:** (+5/-8dB @ 1kHz) Boost and cut "Q Optimized" band pass EQ. This works on lower string harmonics and effects the punch of your sound.
- 9 Lo-Mid:** (+6/-9dB @ 250Hz) Boost and cut "Q optimized" band pass EQ. This works for the main body of your sound.
- 10 Bass (push):** (+/-14dB @ 40Hz) Boost and cut shelving EQ. This is used to control the low end push of your sound.
Push Deep: (+4dB @ 30Hz) Extends the low frequency range of the amplifier to accommodate the extra low range of the B string on a 5 or 6 string bass. Users of 4 string basses may also find desirable results with this filter as well. Pushing the Bass knob toggles the Deep circuit off (knob lit white) and on (knob lit blue).
- 11 Level B:** This is the volume control prior to the Master when Gain B is activated. When used in conjunction with the Gain B knob, varying amounts of tube overdrive and/or volume boost are available. Level B is lit blue when active.
- 12 Master (push):** This is the final master volume when Gain A or Gain B/Level B are activated. This sets the overall output of the amplifier once the appropriate volume ratio between the Gain A and Gain B are set.
Push Limiter: Prevents the power amp from distorting and is recommended during high volume applications. Upon powering up the amplifier, the Master knob indicator is lit blue indicating the limiter is engaged. When the Master knob is pushed the limiter function is disengaged and the knob indicator changes to white. If power amp clipping occurs, the knob indicator will flash red indicating that the limiter function should be engaged.
- 13 Power Switch:** Turns the amplifier on and off. When pushed to the in (on) position, the ring surrounding the button will light red during power up then change to blue, indicating the amp is ready for normal operation. Should the amp experience a fault (overheat or over current) the amp will mute and the ring will light red until the condition is corrected. This LED turns off when the power is switched to the out (off) position. This turns the amp off but it does not completely disconnect the power from the AC mains.

MB FUSION 800

Gain A/B Sample Setting



The switchable **Gain A** and **Gain B** settings can be used to achieve a volume boost or volume cut as well as to add “GK growl” when selected by the footswitch or by pressing the corresponding knob on the front panel. The illustration above shows one possible setting for clean, high

headroom when **Gain A** is active and a more overdriven tone when **Gain B** is activated. **Level B** is used to determine the relative volume while **Gain B** is selected. The Master sets the overall output while either **Gain A** or **Gain B** are active.

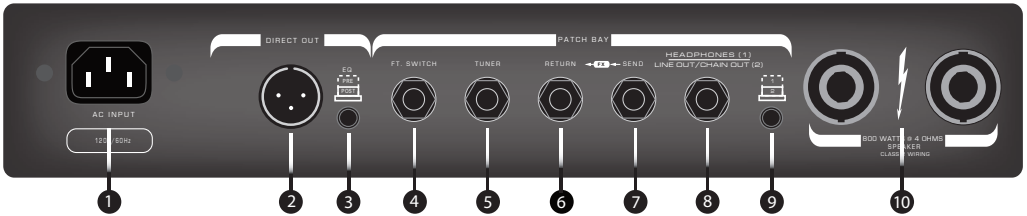

Rear Panel Features

- 1 **AC Receptacle:** The detachable power cord plugs in here.
- 2 **Balanced Direct Out:** This electronically balanced output allows a direct connection to a P.A. system.
- 3 **Pre/Post EQ Button:** This button switches the direct out signal to be before or after the EQ.
- 4 **Foot switch Input:** A foot switch is provided to toggle between Gain A and Gain B modes.
- 5 **Tuner Output:** This output comes directly off of the input stage and can be patched to a tuner using a shielded patch cord. This output is unaffected by the Tuning Mute Feature.
- 6 **Return:** This input allows the signal from outboard effects devices to be inserted before the boost section.
- 7 **Send:** This output allows signal from the preamp to be fed to outboard effects devices from a point after the EQ section.
- 8 **Headphone/Line out/Chain out:** This unique output allows the user to send a direct

(unbalanced) line out to devices with unbalanced inputs such as personal multitrack recorders. This connection requires a shielded patch cord. The Chain out allows the user to connect directly to a GK MBP powered extension cabinet. This connection is made with a balanced, tip, ring, sleeve to male XLR cable.

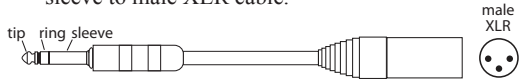

Unswitched, this headphone jack can be used to monitor your playing with headphones.

- 9 **Headphone/Line Out/Chain Out switch:** This button toggles the output from headphone to line/chain out.
- 10 **Speaker:** The speaker output to a speaker cabinet delivers 800w into 4 Ohm loads. Lower impedances such as 8 Ohms or 16 Ohms and no load are acceptable. One 4 Ohm speaker and one 8 Ohm speaker is not recommended. A high current twist-lock 2 pin or 4 pin GK Speakon connector is required for this connection.

MB FUSION 800

MB FUSION 800 BLOCK DIAGRAM

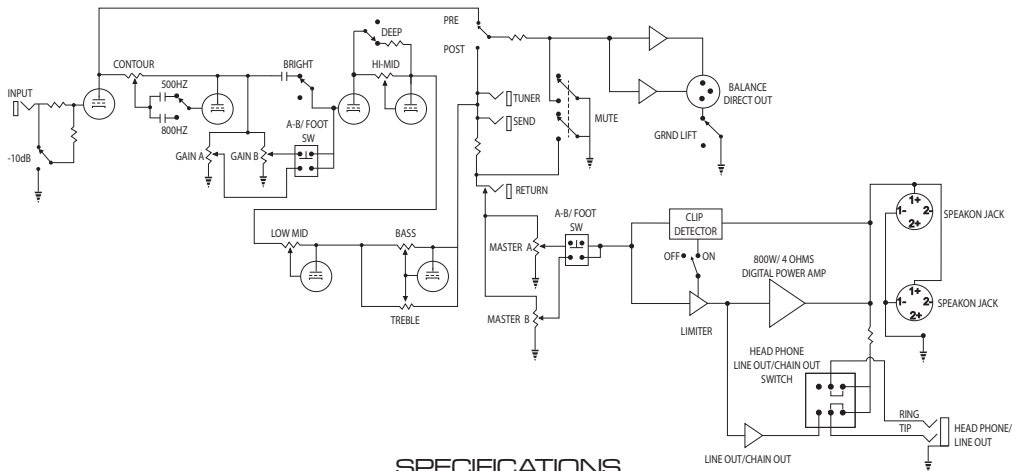

SPECIFICATIONS

Power Output: 560W @ 8 Ohms
800W @ 4 Ohms

Audio Inputs:
Instrument Input 1/4" Mono, Unbalanced
Level 0.6 Vrms
w/ -10dB 1.6 Vrms
Impedance 1 M Ohm
Return Input 1/4" Mono, Unbalanced
Impedance 50k Ohms

Audio Outputs:
Send Output 1/4" Mono, Unbalanced
Impedance 220 Ohms
Tuner Output 1/4" Mono, Unbalanced
Impedance 10K Ohms
Direct Out XLR, Balanced
Impedance 500 Ohms

Speaker Out Speakon Jack, x2

Equalizer:
Bass +/-14dB @ 40Hz
Lo-Mid +6/-9dB @ 250Hz
Hi-Mid +5/-8dB @ 1kHz
Treble +10/-19dB @ 7kHz

Voicing Filters:
Contour -16dB @ 500Hz or
-15dB @ 800Hz
Deep +4dB @ 30Hz
Bright +4dB @ 10kHz

Noise: -90dB "A" weighted
Cooling: Variable Speed Fan

Protection: Full short circuit, thermal, RF protection Stable into reactive and mismatched loads. Five second muted warm up

Dimensions: 1.75" [44.45mm] High
11.00" [279.40mm] Wide
12.25" [311.15mm] Deep
1 Rack space

Weight: 5.5lbs.
Consumption: 880W (Full)
160W (Average)

Mains Voltage: USA/CANADA 120 Volts, 60Hz
UK/Australia 240 Volts, 50Hz
Europe 230/240 Volts, 50/60Hz
Japan 100 Volts, 50/60Hz
Korea 220 Volts, 50 Hz
Mains: Standard IEC Receptacle.

LR110409 This device has been tested and found to comply with CAN/CSA 60065-03 Safety Requirements.
UL  **US** UL std. No. 60065-2007 Safety Requirements.



This device complies with Part 15 of the FCC Rules. Operation is subject to the following two conditions:

- (1) This device may not cause harmful interference, and
- (2) This device must accept any interference received, including interference that may cause undesired operation.

Note: This equipment has been tested and found to comply with the limits for a Class B digital device, pursuant to part 15 of the FCC Rules.

GALLIEN-KRUEGER

MB FUSION 800 BASS AMPLIFIER

OWNER'S MANUAL

PART # 160-0710-A