



MB Combo
OWNER'S MANUAL

MB SERIES COMBOS

Congratulations!

Your purchase of a new Gallien-Krueger amplifier is surely the result of much careful consideration on your part. For our part, we at Gallien-Krueger are pleased that you chose us, and are determined that you will be a satisfied customer. In choosing a GK amplifier, you now own an amplifier with many unique features which will allow you to create your own distinct sound.

To get the most out of your new purchase, please take a few minutes to read through this manual. If you are in a hurry, we suggest you at least read through the Quick Start section before setting up your new rig. This will help get you started and give you a few quick tips, but is not a substitute for reading the rest of the manual.

Your amplifier should have come with the following items, please check the contents of the box to ensure that you have everything.

Included with your MB Series Combo Amplifier:

Power cord	1
Owner's manual	1
Warranty card (US only)	1
Safety instructions sheet	1

If your amplifier did not come with all the items listed, or if you encounter problems while setting up your new equipment, please contact your local dealer or GK as soon as possible.

Gallien-Krueger, Inc.
2234 Industrial Drive
Stockton, CA 95206
phone: (209) 234-7300
fax: (209) 234-8420
Internet: www.gallien-krueger.com
Email: info@gallien.com

We wish you a lifetime of good playing and remember to always have fun!



GK Philosophy

I have never seen the point in doing things the way others have done them. I also have not been very interested in following the latest fad. I'm a Stanford educated engineer who worked my way through school as a musician. Like all musicians, I have lugged amplifiers up stairways and into car trunks, always wondering why these things had to be so heavy, bulky, and hard to handle.

As the principal innovator at GK, our products reflect my attitudes and life experiences. I don't model my designs after other manufacturers' products. Instead, I believe new and old problems are best solved with new solutions. Having taken our own path, GK products enjoy a unique, unmatched sound, allowing you every opportunity to make an original statement.

Having supported my products for over thirty years, I have learned from the story they tell. Gallien-Krueger is a reflection of that story, and has a commitment to support that legacy. Just as the products I created over thirty five years ago are still telling their story, the products we create today will be talking to us tomorrow.

We'll be listening.

A handwritten signature in black ink that reads 'Robert Gallien'. The signature is written in a cursive, flowing style.

**Robert Gallien
Founder and President**

MB SERIES COMBOS

Table Of Contents

Safety Information _____	4
Quick Start/Tech Talk _____	5
MB210/212/115/410 Panel Controls _____	6
MB112 Panel Controls _____	7
MB110 Panel Controls _____	8
Specifications _____	9





*All Features and specifications are subject to change without notice

Gallien-Krueger
2234 Industrial Drive
Stockton, CA 95206
phone: 209.234.7300
fax: 209.234.8420

email: info@gallien-krueger.com
internet: www.gallien-krueger.com

Warning!

This amplifier is capable of producing high sound pressure levels. Continued exposure to high SPL's can cause damage to your hearing. Always set the volume at a safe listening level or use hearing protection if the unit is operated at higher levels.

	CAUTION RISK OF ELECTRIC SHOCK DO NOT OPEN	
CAUTION: TO REDUCE THE RISK OF ELECTRIC SHOCK, DO NOT REMOVE TOP COVER. NO USER-SERVICEABLE PARTS INSIDE. REFER SERVICING TO QUALIFIED SERVICE PERSONNEL.		
	The lightning flash with arrow head symbol, within the equilateral triangle, is intended to alert the user to the presence of uninsulated 'dangerous voltage' within the product enclosure that may be of sufficient magnitude to constitute a risk of electric shock to persons.	
The exclamation point within an equilateral triangle, is intended to alert the user to the presence of important operating and maintenance (servicing) instructions in the literature accompanying the appliance.		
WARNING: TO REDUCE THE RISK OF FIRE OR ELECTRIC SHOCK, DO NOT EXPOSE THIS APPLIANCE TO RAIN OR MOISTURE		
CAUTION: TO PREVENT ELECTRIC SHOCK, MATCH WIDE BLADE OF PLUG TO WIDE SLOT, FULLY INSERTED.		
ATTENTION: POUR EVITER LES CHOCS ELECTRIQUES, INTRODUIRE LA LAME LA PLUS LARGE DE LA FICHE DANS LA BORNE CORRESPONDANTE DE LA PRISE ET POUSSER JUSQU'AU FOND.		

Safety Information

Please read all enclosed safety precautions before connecting or operating this product.

Verify Line Voltage and Amperage

Your amplifier has been factory configured for use with the specific line voltage for your location only. For example, units set to operate within countries that supply 100-120 volt electrical service are not compatible with 230-240 volt systems used in other countries.

120 Volt/60Hz 15 amp circuit for the USA and Canada.

230 Volt/(50/60Hz) 10 amp circuit for the UK and Australia.

230 Volt/(50/60Hz) 10 amp circuit for Europe.

100 Volt/50Hz 15 amp circuit for Japan.

220 Volt/50Hz 10 amp circuit for Korea.

Proper AC circuit for all other countries.

Connecting the amplifier to a line with specifications other than indicated above can create safety and fire hazard, and may damage the amplifier. If you have any questions about the voltage requirements for your specific model, or about the line voltage in your area, contact your dealer before plugging the unit into a wall outlet.

Verify AC Circuit Capacity Before Use: The high power output of your amplifier may require heavy current draw under full load conditions. To insure proper performance and avoid potential safety hazards, we recommend connection to line circuits with amperage specified "as above". Connecting to the same circuit used by other heavy power devices, such as high wattage lights, may cause circuit breakers to trip. It is always a good idea to avoid using any audio equipment on the same AC circuit as equipment with motors, such as air conditioners or refrigerators. This will lessen the possibility of power variation and electrical start up noise affecting your sound.

AC Power Cord: To avoid safety hazards, use only the power cord supplied with your unit. If a replacement cord is needed, make certain to use a standard IEC compliant cord. Damaged power cords should be replaced immediately. When setting up, make certain that the AC plug is easily accessible. If you do not intend to use the amplifier for a considerable length of time, disconnect the plug from the AC mains socket. Do not use an extension cord.

Earth Grounding Connection: To prevent electric shock, do not remove the grounding plug on the power cord, or use any plug or extension cord that does not have a grounding plug provided. Make certain that the AC outlet is properly grounded as well. Do not use an adapter plug with this product.

Do Not Open the Amplifier Enclosure: There are no user serviceable parts inside this product. Opening the amplifier enclosure may present a shock hazard. Modification to the product will void your warranty. If liquid enters the unit, or any metal object such as a paper clip accidentally falls inside the enclosure, disconnect the unit from the AC power source immediately and consult an authorized service station.

Setup: To insure proper operation and to avoid potential safety hazards, place the unit on a firm, level surface. Do not plug or unplug the instrument or speaker cable while the amplifier power is on.

Heat & Ventilation: For proper ventilation, make sure there is at least 8" or 20cm clearance at the back of the unit. Avoid using in extremely hot or cold locations and areas that are exposed to direct sunlight or near heating equipment. Avoid using in moist or high humidity areas.

MB SERIES COMBOS

Quick Start

The MB Series Combos are designed to be simple to operate and all controls have a well defined purpose. These directions will take you through the basics and give you a good start for setting up your sound.

Connect your cabinets (MB210 only): In addition to its internal speakers, the MB210 can power an external speaker cabinet from the output marked “Speaker” located on the rear panel. The external speaker load must be 8 ohm or above.

Connect your MBP to your MB Combo: Using a standard XLR microphone cable, connect the Chain Output located on the rear panel of your MB Combo (see page 6, rear panel item #20) to the Chain Input of your MBP enclosure. If connecting multiple MBP enclosures, the Chain Output of the MBP is connected to the additional MBP’s Chain Input.

Initial front panel control settings: MB210, MB115, MB410 and MB212: Set all EQ and boost controls to 12 o’clock. The input gain and master volume should be set to 0 and the contour and horn buttons in the off (out) position.
MB112 and MB110: Set all EQ controls to 12:00 and the contour in the out position. The input gain should be set to zero.

Level and Master Volume settings: Set the master volume to 12 o’clock. (MB210, MB115, MB410 and MB212 only) While playing, turn the input gain up to the desired volume level. At this point you can experiment with different EQ, contour, horn and boost settings.

*Some passive instruments can have output levels similar to active electronics. If the sound is distorted the -10db pad should be used.

Tech Talk

Equalization: Standard tone controls and graphic equalizers give you plenty of variation, but they don’t provide what the instrument really needs. The fact is, graphic equalizers are intended for room equalization. The equalization in Gallien-Krueger amplifiers reflects 40 years of continuous development and refinement.

The GK equalizer is unique to the industry, it’s not just a normal four band equalizer, each section is a special circuit optimized to perform a Bass specific job in its range of operation. These sections are wired in series, adding to one another, to create a tremendously flexible equalizer that sounds natural at any setting. Now it is possible to obtain the sound you desire.

Contour: The Contour is used to completely revoice the amplifier by tuning between two different shaping circuits, with greatly different responses. With the control engaged, the low end is slightly boosted, the mids are dropped and the high end is pushed up.

G.I.V.E. Technology: The MB210, MB410, MB115 and MB212 preamps incorporate what we call G.I.V.E (Gate Induced Valve Effect) Technology. We use field effect devices with the gate biased in a way that emphasizes the optimum harmonic content of the signal. Working in conjunction with our unique four band active equalizer and contour, G.I.V.E. technology produces a consistently pleasing bass tone.

Smart Protection Circuitry: The MB Series protection circuitry constantly monitors for unsafe operating conditions such as short circuits, miswired speaker cables, blown speakers, improper ventilation, and incorrect speaker configurations. In addition, protection is provided during power up/down. If the MB Series senses any unsafe operating conditions, the output signal is immediately muted and the power light changes from Blue to Red. The amplifier will remain muted until the fault is removed. Be sure that you are not exceeding the maximum recommend load described in this manual. If the problem persists, contact GK directly for technical advice.

MB SERIES COMBOS

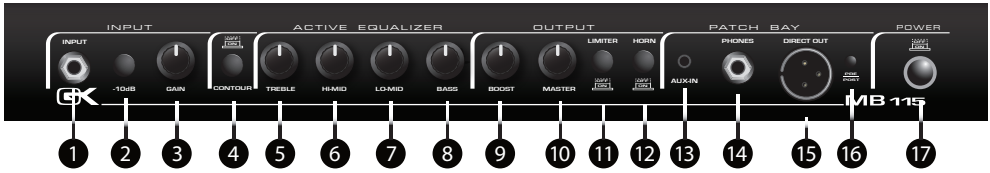

MB210, MB212, MB115, MB410 Control Panel Features

- 1 Input:** A standard 1/4" input to connect instruments using a shielded cable.
- 2 -10dB:** Used to reduce the input signal from active instruments or other high input sources.
- 3 Gain:** Sets the preamp gain after the input stage. It is used in conjunction with the input pad to optimize the amplifier's headroom.
- 4 Contour:** In the on position the button decreases the mid-range frequencies while boosting low and high frequencies.
- 5 Treble:** Boost and cut at 7 kHz shelving type. Use this control to add or remove edge and definition.
- 6 Hi-Mid:** Boost and cut at 1 kHz. A "Q optimized," band pass type works on lower string harmonics and effects the punch of your sound.
- 7 Lo-Mid:** Boost and cut at 250Hz. A "Q optimized" band pass type, effects the main body of your sound.
- 8 Bass:** Boost and cut at 60Hz, shelving type used to control the low end push.
- 9 Boost:** Adds a post EQ gain stage using G.I.V.E. technology adding "growl" as it is turned up.
- 10 Master:** The master volume is used to control the overall output level.
- 11 Limiter:** When this button is engaged it prevents the power amp from distorting. It is recommended that this feature is used for high volume applications.
- 12 Horn:** Activates the high frequency tweeter.
- 13 Aux In:** This 1/8" input for a CD or MP3 player allows the user to monitor an external audio source.
- 14 Phones:** Headphone output. When the phones are connected, the signal sent to the speaker is interrupted.
- 15 Balanced Direct Out:** This electronically balanced output allows a direct connection to a P.A. system.
- 16 Pre/Post:** This button selects the direct out signal to be before or after the EQ.
- 17 Power Switch:** Turns the amplifier on and off. In the on position, the ring surrounding the

button will light red during power up then changes to blue, indicating the amp is ready for normal operation. Should the amp experience a fault (over heat or over current) the amp will mute and the ring will light red until the condition is corrected. This LED turns off when the power is switched off. This turns the amp off but it does not completely disconnect the power from the AC mains.

Rear Panel

- 18 Chain Out:** This XLR output sends all EQ and volume settings to Gallien-Krueger MBP series powered cabinets. This connection is made with a standard XLR mic cable.
- 19 AC Receptacle:** The detachable power cord connects here.
- 20 Speaker Out (MB210 only):** Power amp output to an external speaker cabinet. A twist lock Speakon connector allows the connection of a cabinet with an 8 ohm minimum load.

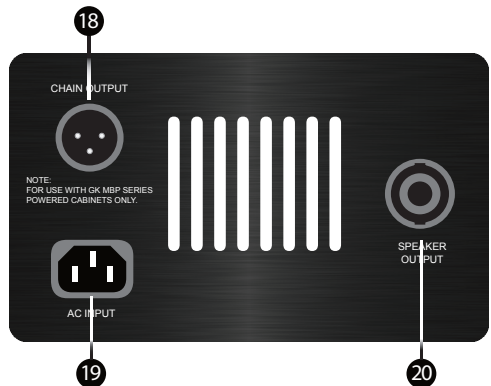

MB SERIES COMBOS



MB112 Control Panel Features

- 1 Input:** A standard 1/4" input to connect instruments using a shielded cable.
- 2 -10dB:** Used to reduce the input signal from active instruments or other high input sources.
- 3 Gain:** Sets the preamp gain after the input stage. It is used in conjunction with the input pad to optimize the amplifier's headroom.
- 4 Contour:** In the on position the button decreases the mid-range frequencies while boosting low and high frequencies.
- 5 Treble:** Boost and cut at 1 kHz. A "Q optimized" band pass type works on lower string harmonics and effects the punch of your sound.
- 6 Hi-Mid:** Boost and cut at 250Hz. A "Q optimized" band pass type, effects the main body of your sound.
- 7 Lo-Mid:** Boost and cut at 60Hz, shelving type used to control the low end push.
- 8 Bass:** Boost and cut at 60Hz, shelving type used to control the low end push.
- 9 Aux In:** This 1/8" input for a CD or MP3 player allows the user to monitor an external audio source.
- 10 Phones:** Headphone output. When phones are connected, the signal sent to the speaker is interrupted.
- 11 Balanced Direct Out:** This electronically balanced output allows a direct connection to a P.A. system.
- 12 Pre/Post:** This button selects the direct out signal to be before or after the EQ.
- 13 Power Switch:** Turns the amplifier on and off. In the on position, the ring surrounding

the button will light red during power up then changes to blue, indicating the amp is ready for normal operation. Should the amp experience a fault (over heat or over current) the amp will mute and the ring will light red until the condition is corrected. This LED turns off when the power is switched off. This turns the amp off but it does not completely disconnect the power from the AC mains.

Rear Panel

- 14 Chain Out:** This XLR output sends all EQ and volume settings to Gallien-Krueger MBP series powered cabinets. This connection is made with a standard XLR mic cable.
- 15 AC Receptacle:** The detachable power cord connects here.

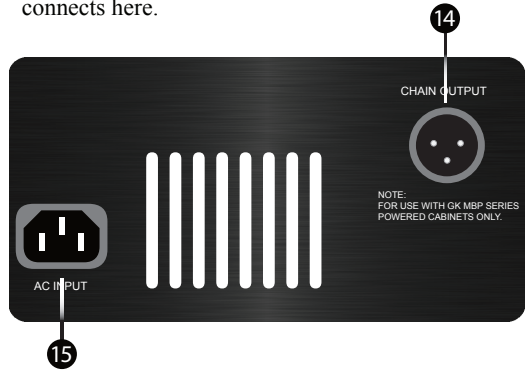

MB SERIES COMBOS



MB110 Control Panel Features

- 1 **Input:** A standard 1/4" input to connect instruments using a shielded cable.
- 2 **-10dB:** Used to reduce the input signal from active instruments or other high input sources.
- 3 **Gain:** Sets the preamp gain after the input stage. It is used in conjunction with the input pad to optimize the amplifier's headroom.
- 4 **Contour:** In the on position the button decreases the mid-range frequencies while boosting low and high frequencies.
- 5 **Treble:** Boost and cut at 7 kHz shelving type. Use this control to add or remove edge and definition.
- 6 **Hi-Mid:** Boost and cut at 1 kHz. A "Q optimized," band pass type works on lower string harmonics and effects the punch of your sound.
- 7 **Lo-Mid:** Boost and cut at 250Hz. A "Q optimized" band pass type, effects the main body of your sound.
- 8 **Bass:** Boost and cut at 60Hz, shelving type used to control the low end push.
- 9 **Aux In:** This 1/8" input for a CD or MP3 player allows the user to monitor an external audio source.
- 10 **Phones:** Headphone output. When phones are connected, the signal sent to the speaker is interrupted.
- 11 **Power Switch:** Turns the amplifier on and off. In the on position, the ring surrounding the button will light red during power up then changes to blue, indicating the amp is ready for normal operation. Should the amp experience a fault (over heat or over current) the amp will mute and the ring will light red until the condition is corrected. This LED turns off when the power is switched off. This turns the amp off but it does not completely disconnect the power from the AC mains.

Rear Panel Features

- 12 **AC Receptacle:** The detachable power cord connects here.
- 13 **Pre/Post:** This button selects the direct out signal to be before or after the EQ.
- 14 **Balanced Direct Out:** This electronically balanced output allows a direct connection to a P.A. system.
- 15 **Chain Out:** This XLR output sends all EQ and volume settings to Gallien-Krueger MBP series powered cabinets. This connection is made with a standard XLR mic cable.

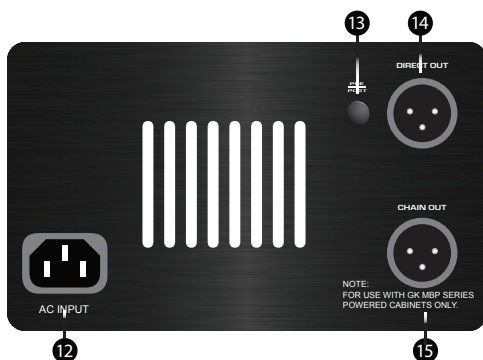

MB SERIES COMBOS

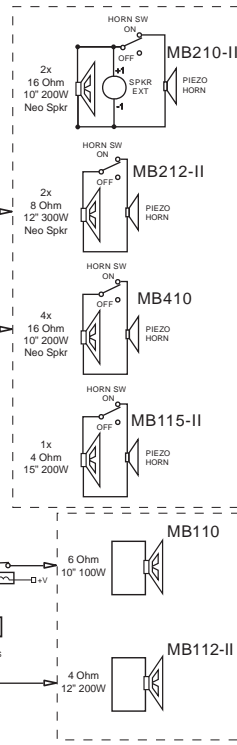
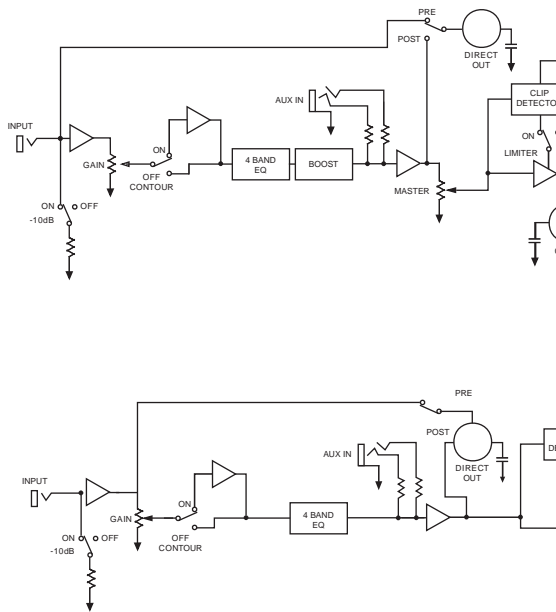

Output Power:

MB210-II	350W@8 Ohms (internal) 500W@4 Ohms (w/extension)
MB212-II	500W@4 Ohms
MB410	500W@4 Ohms
MB115-II	200W@4 Ohms
MB112-II	200W@4 Ohms
MB110	100W@6 Ohms

Input Section:

Maximum Input Level	0.6V rms
Input Impedance	1M Ohms
Direct Output Impedance	500 Ohms
Aux-in Input Impedance	100K Ohms

Equalizer:

Bass	+/-10dB@60Hz
Lo-Mid	+6dB/-10dB@250Hz
Hi-Mid	+6dB/-10dB@1KHz
Treble	+/-14dB @ 7KHz

Voicing Filters:

Contour	+2dB @50Hz/-10dB@500Hz/ +3dB @ 7 KHz
---------	---

Noise:

MB210-II	-90 dB reference to 500W/350, 'A' weighted
MB212-II	-90 dB reference to 500W, 'A' weighted
MB410:	-90 dB reference to 500W, 'A' weighted
MB115-II	-90 dB reference to 200W, 'A' weighted
MB112-II	-90 dB reference to 200W, 'A' weighted
MB110	-90 dB reference to 100W, 'A' weighted

Amplifier Protection:

Full short circuit, thermal and RF protection. Stable into reactive and mismatched loads. Five second muted warm up.

Dimensions (HxWxD):

MB210-II	23"x19"x14.5"	Weight:	35 lbs.
MB212-II	26"x19"x14.5"		41 lbs.
MB410	23"x23"x16"		51 lbs.
MB115-II	23"x19"x14.5"		38 lbs.
MB112-II	17"x15"x14.5"		30 lbs.
MB110	16"x13"x11.5"		20 lbs.

Power requirements:

MB210-II, MB212-II
 U.S.A./Canada 120V/60Hz.
 & MB410 580W(full power), 128W(average power)
 Europe 230V/50Hz/60Hz
 580W(full power), 128W(average power)
 Japan 100V/50Hz
 580W(full power), 128W(average power)

MB115-II & MB112-II
 U.S.A./Canada 120V/60Hz.
 240W(full power), 48.6 W (average power)
 Europe 230V/50Hz/60Hz
 240W(full power), 48.6W(average power)
 Japan 100V/50Hz
 240W(full power), 48.6W(average power)

MB110
 U.S.A./Canada 120V/60Hz.
 140W (full power), 28.6 W (average power)
 Europe 230V/50Hz/60Hz
 240W(full power), 28.6W(average power)
 Japan 100V/50Hz
 240W(full power), 28.6W(average power)



This device complies with Part 15 of the FCC Rules. Operation is subject to the following two conditions: (1) this device may not cause harmful interference, and (2) this device must accept any interference received. Note: This equipment has been tested and found to comply with the limits for a Class B digital device, pursuant to part 15 of the FCC Rules.

LR110409



This device has been tested and found to comply with: CAN/CSA 60065-03 Safety Requirements. UL std. No. 60065-2007 Safety Requirements.



MB Combo Owners Manual
Part # 160-0520-F