

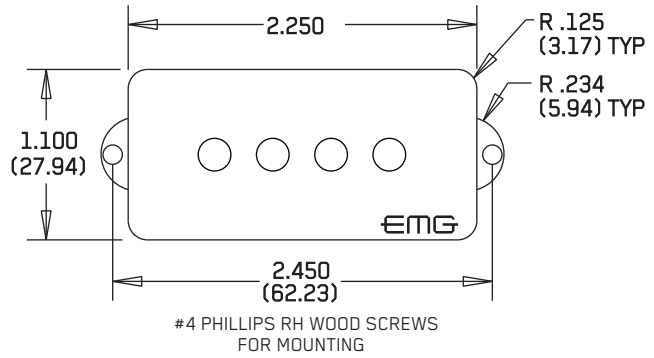

0230-0282F-D

PO BOX 4394  
SANTA ROSA, CA  
95402 USA

P (707) 525-9941  
F (707) 575-7046  
EMGPICKUPS.COM



## INSTALLATION INFORMATION EMG MODELS: P-HZ (GZR MODEL)

### SPECIFICATIONS

Logo Color  
Magnet Type  
Inductance (Henries)  
DC Resistance (kOhm)  
Resonant Frequency (KHz) (1)  
Resonant Frequency (KHz) (2)  
Impedance at Resonance (kOhm) (1)  
(1) Loaded with 500K Volume and Tone  
and 20' (6M) 560pf cable  
(2) Loaded with 1 MegOhm / 47pf

### MODEL:

P-HZ  
Gold  
Alnico 5  
6.12  
11.20  
1.77  
2.36  
68.00

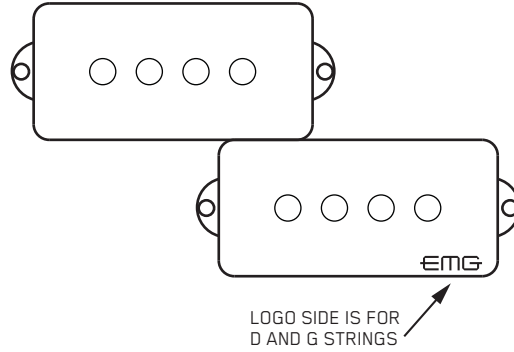

### INSTALLATION NOTES:

As you can see from the diagram above, the P Set consists of two pickups. Both pickups are identical in size and shape. The pickup that features the EMG Logo is intended to be used under the D/G Strings so that the connector cable is long enough to get to the control cavity. All EMG-HZ Pickups are compatible with each other. The connector system is an easy method of installation, avoiding the need to solder. EMG Accessory Circuits like the VLPF, EXB, BTC or BQC Controls can be added to any EMG Pickup System, all have buffered inputs and can be used on either passive or active pickups. Adding Active accessories will require a battery.

### IMPORTANT NOTE:

It is common practice to ground (earth) the strings of an instrument that uses passive pickups to reduce noise. This means there will be a wire coming from the bridge into the control cavity that will be hooked to one of the pots. Included with the EMG-HZ System is a single black wire with a connector on it and an IDC connector that will attach to the existing ground wire and will provide the ground (earth) connection.

### INCLUDED WITH EACH PICKUP:

1 VOLUME CONTROL (250K)  
1 TONE CONTROL (250K)

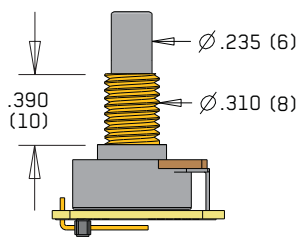

ADJUSTMENT SCREWS(4)

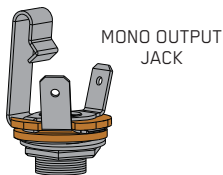
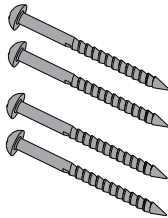

MONO OUTPUT  
JACK

BRIDGE GROUND  
CONNECTOR



P PICKUP CABLE 12" (30cm)

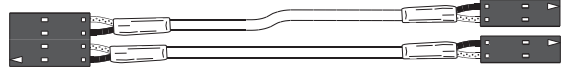

CONNECT CABLES 5.5" (14cm)

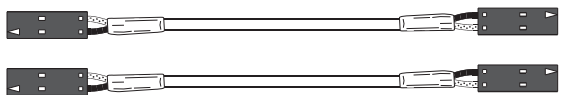

OUTPUT CABLE 6" (15cm)

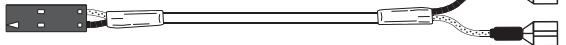

BRIDGE GROUND WIRE 6" (15cm)



### WARRANTY

All EMG Pickups and accessories are warranted for a period of two years. This warranty does not cover failure due to improper installation, abuse or damage. If upon examination the pickup is determined to be defective, a replacement will be made. Warranty replacement products are covered by this same warranty. This warranty covers only those pickups and accessories sold by authorized EMG Dealers. This warranty is not transferable.

**Installation Instructions:**

**EMG Models: P-HZ**

**General Notes:**

Every attempt has been made to make this a solderless installation. There are some instances where this is not possible; 1) If your instrument uses the long panel output jack, soldering will be required.

**Installation**

- 1) Diagram #1 shows how to install the pickup cable onto the back of the pickup. It's a good idea to keep any extra length of cable in the pickup cavity if possible. Route the cable to the control cavity.
- 2) Diagram #2 shows the color code of the cables, be sure to pay attention to the colors when you are installing the pickup and interconnect cables.
- 2) Diagram #3 shows an installation that has just a volume control, while diagram #4 shows the typical P Style installation with a master volume and master tone control.
- 3) If your instrument has a selection switch or the wiring is different, visit our website; [emgpickups.com](http://emgpickups.com) for more diagrams and video installations.

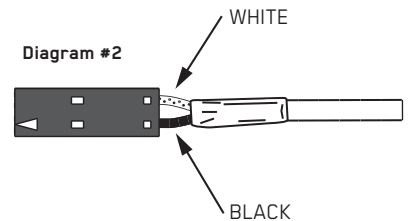
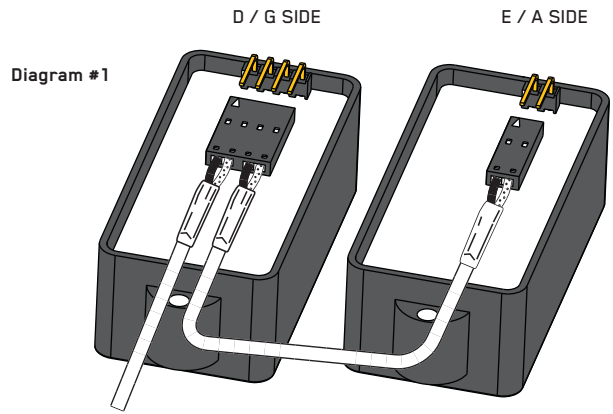

**Diagram #3**

One Pickup  
One Volume

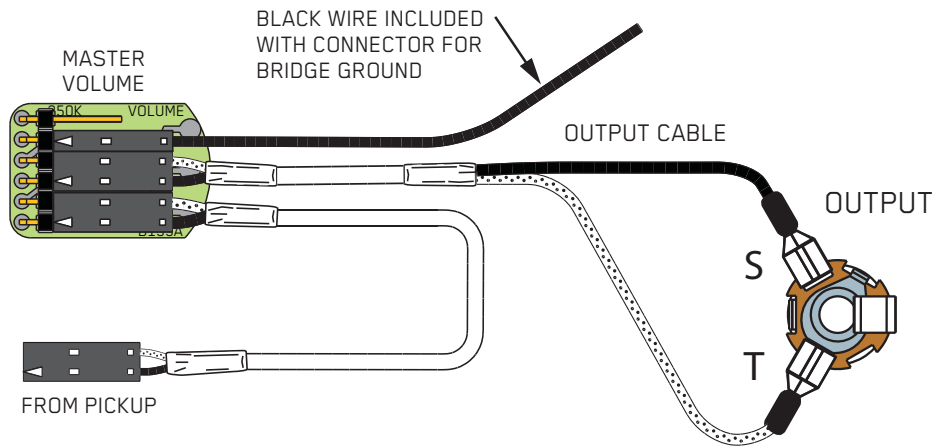

**Diagram #4**

One Pickup  
One Volume  
One Tone

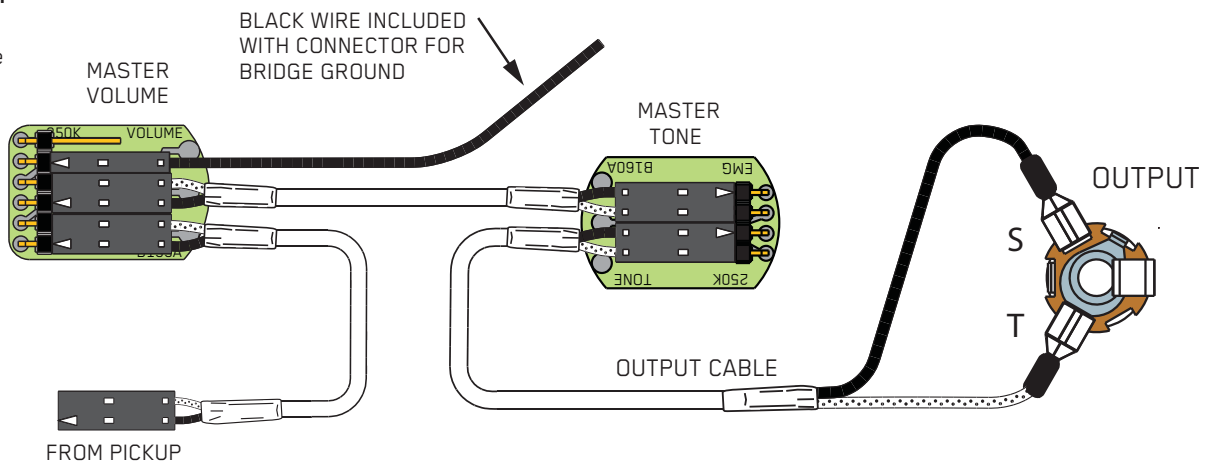

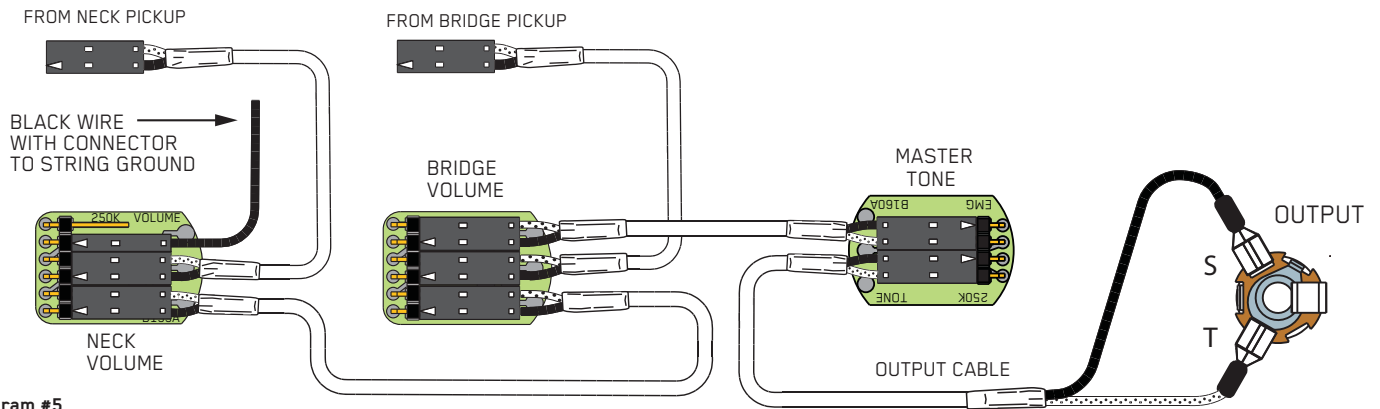
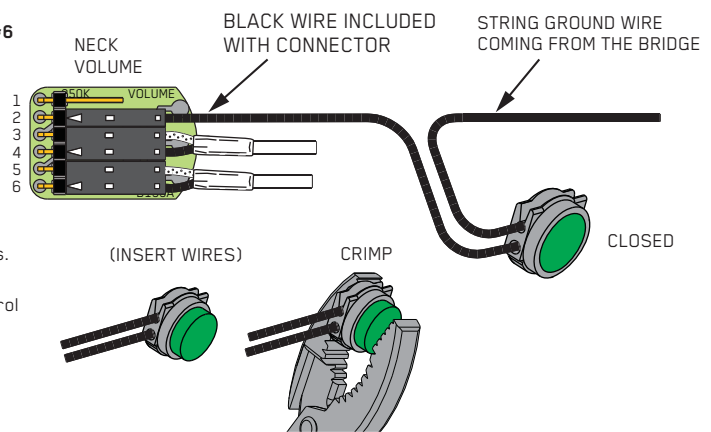

**Diagram #5**  
 2 Pickups  
 Volume / Volume/ Tone

**Attaching the bridge ground wire**  
 6) Refer to Diagram #6.

As mentioned on page 1, it is common to "ground" (earth) the strings on guitars that have passive pickups. Included with the system is a black wire with a single black connector attached. Also included is an IDC connector for connecting the two wires together. Insert the bridge ground wire, and the connector wire into the IDC connector, crimp the connector with a pair of pliers until it snaps and this will connect the two wires. You don't need to strip the insulation from the wires. Push the black connector onto terminal 2 (GND) of the volume control as shown in the diagram. This will ground the strings to the system.

**Diagram #6**



**Soldering to the 151 Panel Jack:**

If your instrument has a long Panel Jack like the one below you will have to solder the output cable as shown.  
 Ground (Black) to the Sleeve  
 Signal (White) to the Tip

**Diagram #7**

