

ARQ

Aero RhythmTrak

AR-48

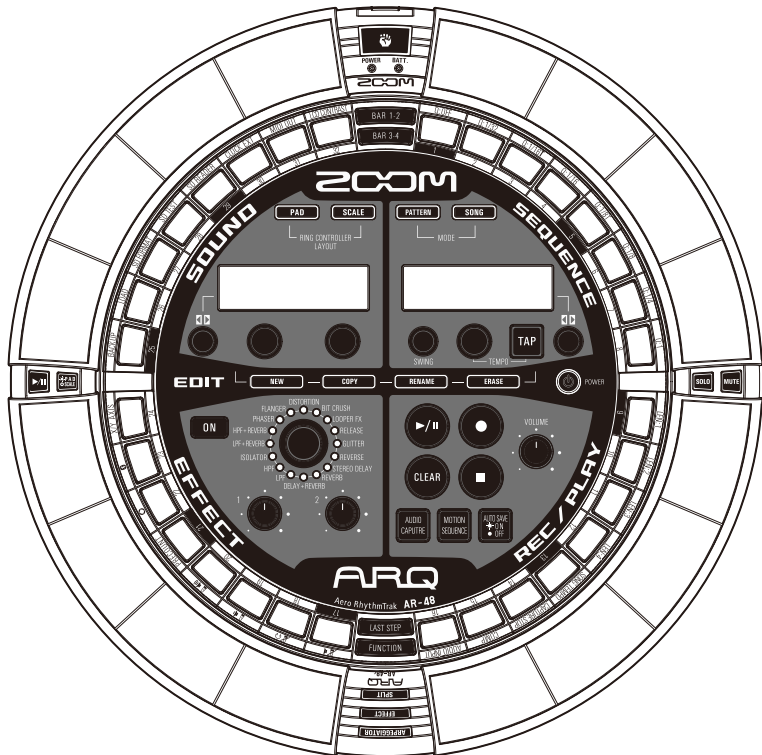

Quick Guide

The Operation Manual can be downloaded from the ZOOM website (www.zoom.co.jp/).

© 2017 ZOOM CORPORATION

Copying or reprinting this manual in part or in whole without permission is prohibited.

Contents

Using the AR-48	3	EFFECT area	
Connecting other devices	3	EFFECT area overview	19
Preparations		Effect settings.....	20
Turning the power on and off	4	REC/PLAY area	
Base Station power	4	REC/PLAY area overview	21
Ring Controller power	4	Ring Controller	
Installing SD cards and		Ring Controller overview	22
BTA-1 units.....	6	Ring Controller operation buttons.....	22
The 4 Base Station areas	7	Using the Ring Controller	23
STEP keys	7	Arpeggiator.....	23
SEQUENCE area		Setting the pad split	24
SEQUENCE area overview.....	8	Using the effect	24
Creating patterns.....	9	Soloing	25
Creating songs	10	Muting	25
SOUND area		Using the grip area.....	25
SOUND area overview.....	11	Other settings	
Instrument block structure	12	STEP key setting items	26
Editing instruments.....	14	Specifications	
Common operations.....	14	Specifications.....	27
SCALE layout settings.....	14		
Oscillator	15		
Noise	16		
Insert effects.....	16		
Filter.....	17		
Volume envelope (ADSR)	17		
Output mixer (OUTPUT)	17		
Effect send amount	18		
LED settings	18		
MIDI settings	18		

Using the AR-48

The **AR-48** consists of a Base Station and a Ring Controller.

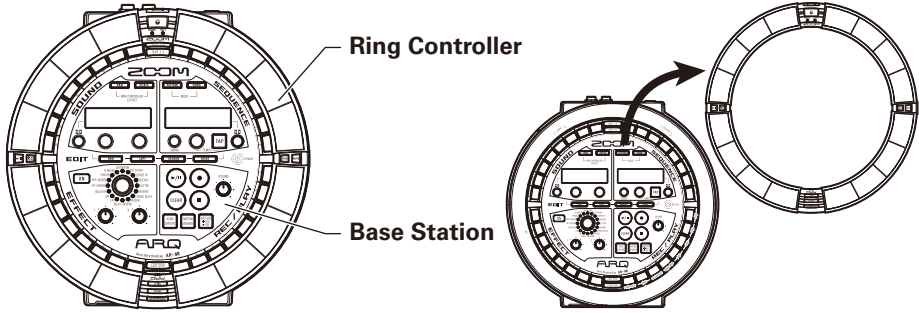

With the Base Station, you can create and save patterns, songs and other musical pieces, as well as edit tones, for example. Use the Ring Controller for input when creating music.

Since the Ring Controller can be detached from the Base Station, you can hold it in your hand and play it like an instrument. You can also connect it by USB or Bluetooth LE to a Mac computer or iOS device and use it as a MIDI controller.

NOTE

BTA-1 units (sold separately) are necessary to connect by Bluetooth LE.

Connecting other devices

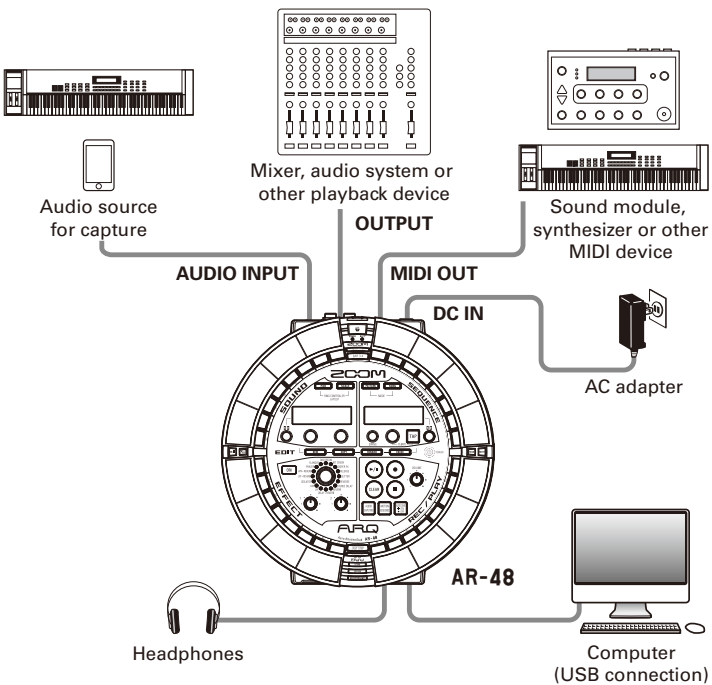



Preparations

Turning the power on and off

Base Station power

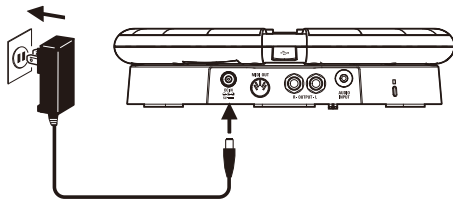
1. Connect the included AC adapter to the Base Station.



2. Press and hold  POWER on the Base Station.

The Base Station software version appears on the screen.

3. Press and hold  POWER to turn the power OFF.

HINT

When the Ring Controller is connected to the Base Station by USB, turning the Base Station power ON/OFF will also turn the Ring Controller ON/OFF.

NOTE

Use the AC adapter to power the **AR-48** even when it is connected to a computer or other device by USB.

Ring Controller power

■ When connected by USB

When the Ring Controller is connected to the Base Station or a computer by USB, it will automatically turn on and operate on USB bus power.

When operating on USB bus power, the Ring Controller POWER LED will light red, and  will be disabled.

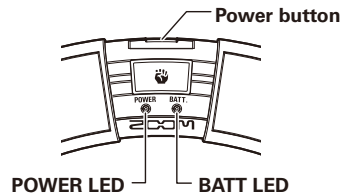

■ When using a BTA-1 and connected by Bluetooth LE

If BTA-1 (sold separately) units have been installed in the Base Station and Ring Controller and they are connected by Bluetooth LE, the Ring Controller will be powered by AA batteries. In this case, the Ring Controller BATT LED will light and  will be enabled.

HINT

- Press  to show the Ring Controller remaining battery charge on the SOUND display.
- Even if a BTA-1 is installed, it will operate on USB bus power if connected by a USB cable.

Turning the power on and off (continued)

■ Turning the Ring Controller on

1. Press  for at least 2 seconds.

This turns on the Ring Controller.

■ Turning the Ring Controller off

1. Press  for at least 2 seconds.

HINT

- When connected to the Base Station by Bluetooth LE, turning off the Ring Controller will also turn off the Base Station.
- When operating on AA batteries, the BATT LED will blink when the remaining battery charge is less than 10%.

■ Changing the Ring Controller batteries

The Ring Controller can be powered by two AA batteries.

1. Turning the Ring Controller off

2. Unlock and remove the battery compartment covers.

The Ring Controller has battery compartment covers in two places.

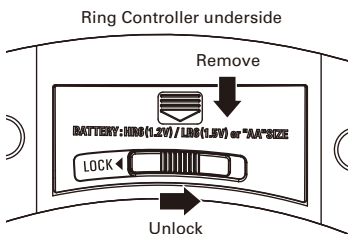

3. Install the batteries.

Be sure to orient the batteries correctly.

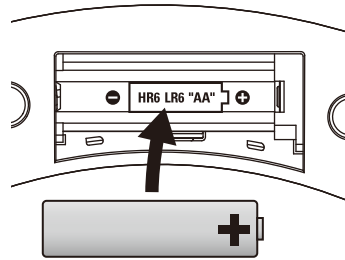

4. Replace and lock the battery compartment covers.

NOTE

Always replace both batteries at the same time with new batteries.

Installing SD cards and BTA-1 units

■ Loading and removing SD cards

1. Turn the power off.
2. Open the SD card slot cover on the Base Station.
3. Insert the SD card into the slot.

To eject an SD card:

Push the card further into the slot and then pull it out.

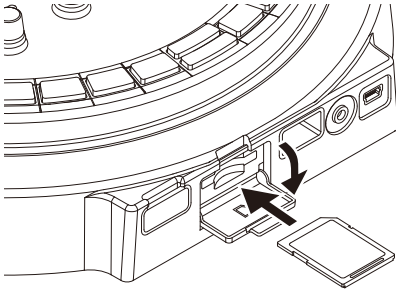

NOTE

- If no SD card is loaded in the **AR-48**, captured data cannot be saved and patterns and songs that are created cannot be backed up.
- When inserting an SD card, be sure to insert the correct end with the top side up as shown.
- Before using SD cards that have just been purchased or that have been formatted on a computer, they must be formatted by the **AR-48**.
- Formatting SD cards (→ Operation Manual)

■ Installing BTA-1 units

1. Turn the power off.

2. Remove the BTA-1 connector covers on the Ring Controller and Base Station.

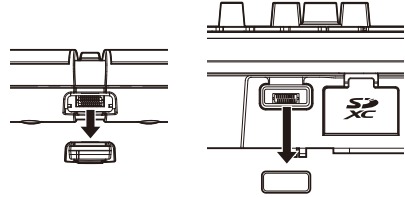

3. Insert the BTA-1 units into the connectors.

To remove a unit, pinch it with your fingers and pull it out.

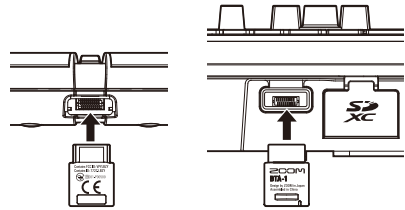

NOTE

- When wireless transmission using BTA-1 units is active, the blue BTA-1 LEDs will light.
- Communication at up to 10 meters is possible in an unobstructed indoor space with BTA-1 units. If interference from electromagnetic waves, for example, prevents communication, try the following.
 - Bring the Ring Controller and the Base Station closer together.
 - Move obstacles between the Ring Controller and the Base Station.
 - Stop unnecessary 2.4 GHz transmissions or move interfering devices further away. (These include Wi-Fi access points, smartphones and other devices that use Wi-Fi, as well as microwave ovens, audio monitors, lighting controls and other devices that communicate at 2.4 GHz.)

The 4 Base Station areas

The Base Station is divided into four areas according to use.

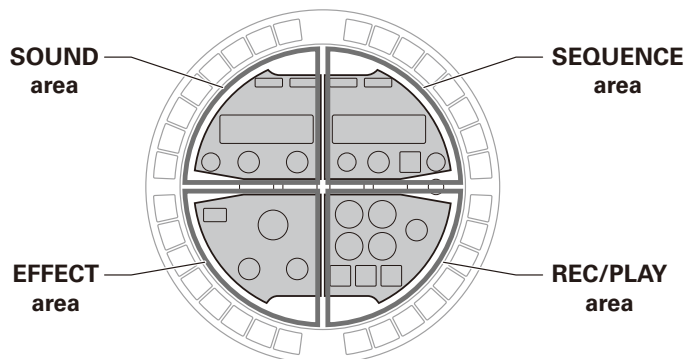

Sound area: Used to control the parameters of instruments assigned to pads. Parameters related to the instrument are shown on the display.

Sequence area: Use to set the tempo and other sequence parameters. The display shows pattern and song names.

REC/PLAY area: Use to control sequences, including playback and recording.

Effect area: Use to control effects applied to output.

STEP keys



The Base Station also has 32 STEP keys () that show pattern sequences and the states of patterns assigned to songs.

■ PATTERN mode

Press a Ring Controller pad, to show the sequence for that instrument on the  step keys.

If the pattern is longer than two bars, the  indications will switch every two bars.

To check the sequence, press  for bars 1-2 and  for bars 3-4.

You can change the last step in one cycle on the Base Station by pressing  while pressing .

For example, you can create patterns in triple time by setting the cycle to 24 steps.

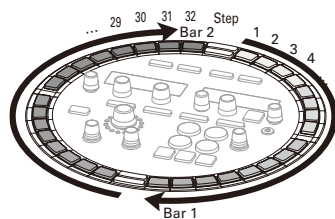

■ SONG mode

In SONG mode, use Base Station  to add patterns for playback in order starting with -1.

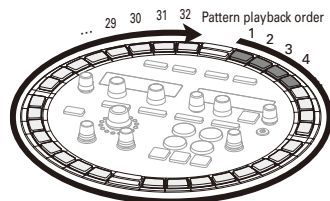

SEQUENCE area overview

The **AR-48** can save up to 384 patterns and 99 songs.

In patterns, you can use up to 16 instruments (sound sources) and record sequences that are 1–4 bars long. The instruments, sequences, parameters controlled by the Ring Controller, quantization and other settings are saved for each pattern separately.

In songs, you can combine multiple patterns to create a complete piece of music.

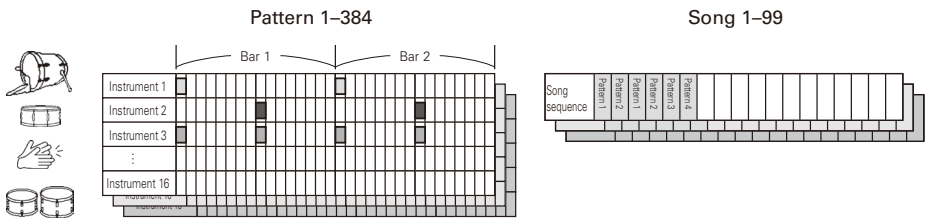

Use the SEQUENCE area to work with patterns and songs.

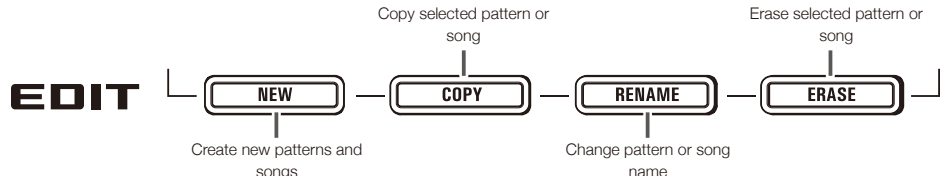
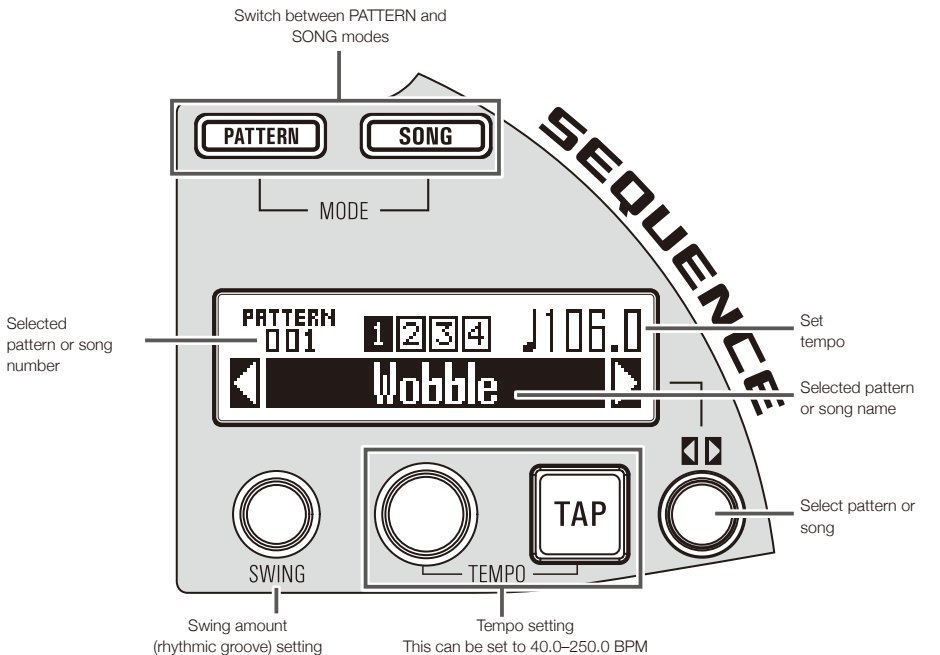

Creating patterns

In PATTERN mode, use the Ring Controller to play instruments.

Use **PAD** and **SCALE** to switch between PAD layout for playing multiple instruments and SCALE layout for playing the selected instrument in a scale.

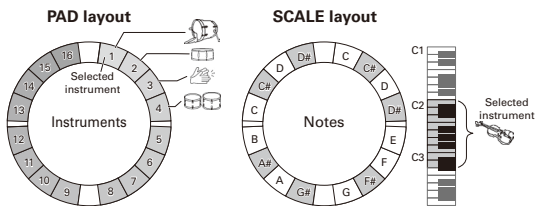

Enter PATTERN mode

Press **PATTERN** to enter PATTERN mode.

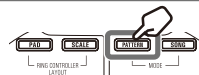

Select a pattern

Turn **CC** in the SEQUENCE area to select the pattern number.

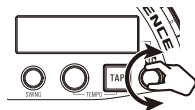

Confirm the instruments

Tap the pads on the Ring Controller if you want to listen to the sounds of the input instruments.

When a pad is tapped, its instrument becomes "selected" and it lights white. The name and parameters of the instrument are shown on the SOUND display.

Press **SCALE** to change the Ring Controller to SCALE layout.

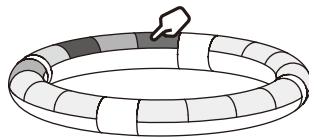

HINT

By pressing **PATTERN** as you tap a pad, you can select its instrument without playing its sound.

① Start real-time input

Press **STOP** to enter standby, and press **▶/R** to start real-time input.

In PAD layout, tap the pads of instruments to input them in time with the pattern that is playing back in a loop.

In SCALE layout, tap the pads of notes to input them in time with the pattern that is playing back in a loop.

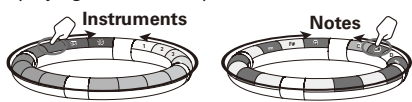

End real-time input

Press **STOP** to end real-time input.

② Start step input

While pressing a pad that corresponds to the instrument to input, press the **EDIT** keys to edit the sequence for that instrument.

In addition, you can tap pads while pressing a **EDIT** key to input instruments (in PAD layout) or notes (in SCALE layout) to input them at that step.

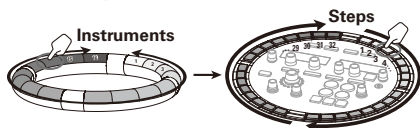

Creating songs

In SONG mode, the pads on the Ring Controller are assigned 16 patterns. You can change the patterns assigned to each pad. Tapping a pad starts playback of its assigned pattern.

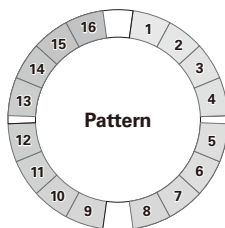

Enter SONG mode

Press **SONG** to enter SONG mode.



Select a song

Turn in the SEQUENCE area to select a song.

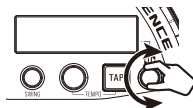

Select a pattern to play back

Tap the pad on the Ring Controller for the pattern to play back, and check it.

HINT

If the pattern you want to play back has not been assigned to a pad, use in the SOUND area to select the pattern to assign to the pad.

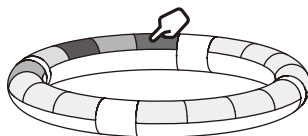

① Start real-time input

Press to start real-time input.



Create a song

Tap pads for patterns to play them and add them to the song in real time.

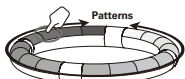

End real-time input

Press to end real-time input.

② Start step input

Press the blinking to add a new pattern at that step.

Press a lit to see information about the pattern at that position on the SEQUENCE display. You can edit pattern information, insert a new pattern, or delete this step, for example.

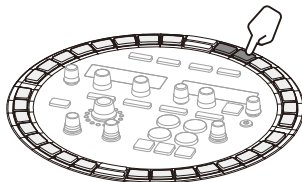

SOUND area overview

In PATTERN mode, you can use up to 16 instruments to perform.

A variety of sound sources, including drum sets, percussion instruments, basses and synthesizers, are already prepared for use.

You can also use WAV files saved on an SD card by a computer as instruments.

In addition to selecting sounds, various settings are available in each instrument. These include envelopes with attack and sustain times, filters and effects.

In SONG mode, the pads on the Ring Controller are assigned 16 patterns.

Tapping a pad starts playback of its assigned pattern.

Change instrument sounds and assigned patterns in the SOUND area.

Changing the Ring Controller layout (PATTERN mode)

PAD: Various instruments can be assigned to the 16 pads and used to perform.

SCALE: The selected instrument can be played with a musical scale, using the pads like a keyboard.

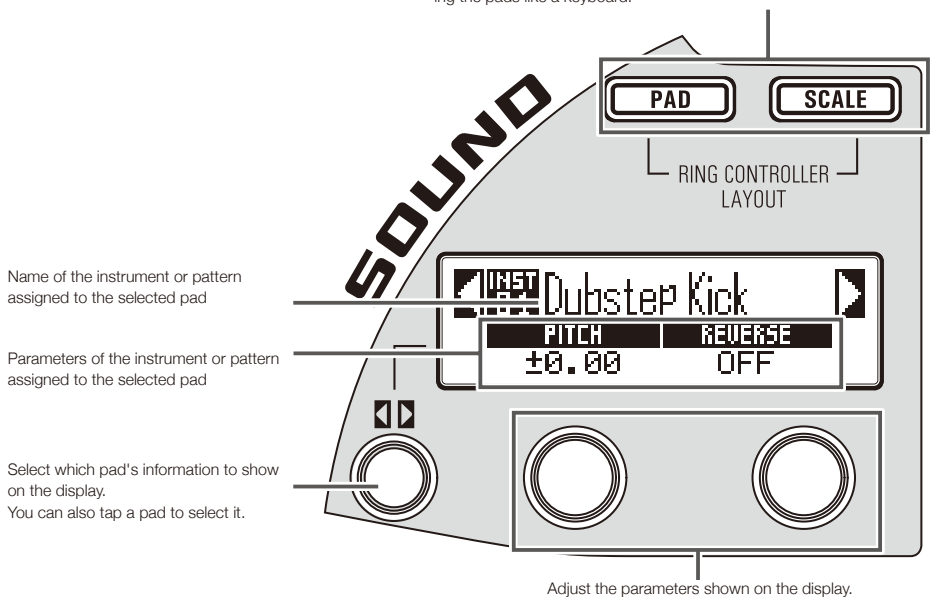

Copy the instrument or pattern assigned to the selected pad to another pad.

Erase the instrument or pattern assigned to the selected pad

EDIT

NEW



COPY

RENAME

ERASE

Edit the name of the selected instrument

Instrument block structure

Use ,  and  in the SOUND area to edit instruments and change their sounds.

The instruments are made of the following blocks, which can each be specifically set.

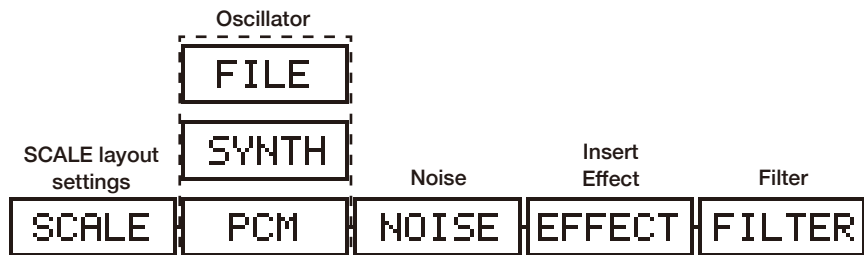

Set the scale and how sound is made when in SCALE layout.

This sets the basic instrument sound. You can select from built-in sound sources, captured recordings and WAV files loaded from the SD card. See the Operation Manual for detailed information about all the sound parameters.

Noise can be added to the sound.

Sounds can be altered with effects.

Sounds can be altered with filters.

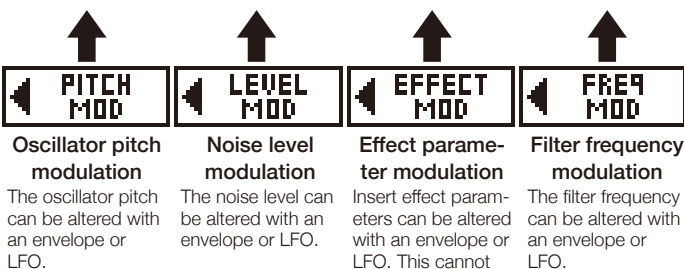

Oscillator pitch modulation

The oscillator pitch can be altered with an envelope or LFO.

Noise level modulation

The noise level can be altered with an envelope or LFO.

Effect parameter modulation

Insert effect parameters can be altered with an envelope or LFO. This cannot be used with some effects.

Filter frequency modulation

The filter frequency can be altered with an envelope or LFO.

Volume
envelope

ADSR

This sets how quickly sound starts when a pad is tapped, the sound level while it is being pressed, and how quickly it becomes silent after the pad is released.

Output mixer

OUTPUT

This sets the panning (stereo position) and level.

Effect
send amount

FX SEND

These set the amounts sent to the delay and reverb effects.

LED settings

LED

This sets the pad color and lighting style.

MIDI settings

MIDI

Use this to set the MIDI channel for playing instrument sounds by USB MIDI and for outputting playing sequences from the MIDI OUT.

Volume
modulation

The volume can be altered with an envelope or LFO.

Pan modulation

The panning can be altered with an envelope or LFO.

NOTE

Modulation blocks will not be shown if their modulation destinations are off.



Editing instruments

Common operations

1.  **CONTROLLER** Tap the pad for the instrument to be edited.

The selected parameters are shown on the SOUND display.



2. Press  and turn  in the SOUND area to select parameters to edit.

  and  to adjust the parameters shown.



HINT

See the Operation Manual for detailed information about each block.

SCALE layout settings

You can set, for example, the octave, scale and whether only a single sound (monophonic) or multiple sounds (polyphonic) can be output when the Ring Controller is in SCALE layout.

■ Octave setting (Octave)

You can change the note range that can be played on the Ring Controller. The octave shown will start on pad 1.

■ Changing the scale (Scale)

The layout of notes on the Ring Controller changes according to the scale set.

This allows you to assign only notes from the desired scale to the Ring Controller.

Select from the following scales.

CHROMATC (Chromatic), MAJOR (Ionian), MINOR 1 (Harmonic Minor), MINOR 2 (Melodic Minor), MINOR 3 (Dorian), PHRYGIAN, LYDIAN, MIXOLYDN (Mixolydian), AEOLIAN, LOCRIAN (Locrian), S-LOCRN (Super Locrian), MajBLUES (Major Blues), MinBLUES (Minor Blues), DIMINISH (Diminished), COM DIM, MajPENTA (Major Pentatonic), MinPENTA (Minor Pentatonic), RAGA 1 (Bhairav), RAGA 2, RAGA 3, ARABIC, SPANISH, GYPSY, MinGYPSY (Minor Gypsy), EGYPTIAN, HAWAIIAN, PELOG, HIROJOSI, IN-SEN, IWATO, KUMOI, MIYAKO, RYUKYU, CHINESE, WHOLE (Whole tone), WHOLE1/2 (Whole half), 5th

■ Polyphony setting (Mono/Poly)

This sets whether only a single sound (monophonic) or multiple sounds (polyphonic) are output when multiple pads are pressed at the same time.

Select Mono or Poly.

■ Setting the glide (Glide)

When a different note is triggered, the pitch can change instantly or gradually over time according to this setting.

This can be set from 0 to 100.

The higher this value is set, the more gradual the change will be.

HINT

Glide is only enabled when the polyphony mode is Mono.

■ Changing the key (Key)

You can change the key when the scale is set to anything other than Chromatic.



You can select from C, C#, D, D#, E, F, F#, G, G#, A, A# and B.

NOTE



The Ring Controller layout also changes according to the key setting.

Oscillator

This sets the basic instrument sound.

- Press  in the SOUND area, and use  to move to the oscillator block.





- Press .
- Use  in the SOUND area to select the oscillator category.
- Use  in the SOUND area to select the oscillator.



■ Selecting captured audio and WAV files

WAV files saved in the "Capture" subfolder in the "AR-48" folder on the SD card can be added as oscillators.

- Select FILE as the oscillator category.
- Use  in the SOUND area to select the audio file on the SD card, and press .

NOTE

When an audio file is selected as an oscillator, the filter and other parameters will be reset to default values.

HINT

- Files that meet the following conditions can be used as oscillators.
 - WAV format files that have been recorded as 16/24-bit PCM audio with 44.1kHz sampling frequency
 - Playback time is 6 minutes (12 minutes if mono) or less
 - File name uses only English letters and numbers
- The total length of audio files that can be added as instruments on the **AR-48** is 6 minutes (or 12 minutes if mono). For example, if a one-minute stereo audio file has been added, the total length of additional audio files that can be added as instruments is 5 minutes (or 10 minutes if mono).
- If an audio file is used in multiple patterns, this will not change the remaining time for assigning additional files.

■ Playing audio files

The playback method for audio files can be set.

- One Shot: The audio file plays once and stops.
- Toggle: Tapping the pad alternately starts and stops playback of the audio file.
- Gate: The audio file plays back in a loop while the pad is being pressed. Playback stops when it is released.

Editing instruments (continued)

Noise

Noise can be added to the sound.

■ Type of noise (Type)

You can change the type of noise.

Select Off, White or Pink.

■ Noise level (Level)

You can change the noise volume.

This can be set from 0 to 100.

Insert effects

Sounds can be altered with effects.

■ Compressor (COMP)

The compressor reduces volume variation.

■ Pumper (PUMPER)

This effect adds a pulsing feeling to the sound.

■ Sub Bass (SUB BASS)

This emphasizes low frequencies.

■ Talk Filter (TALK)

This effect creates a sound like a human voice.

■ 3Band Equalizer (3BAND EQ)

This is a three-band equalizer.

■ Ring Modulator (RING MOD)

This effect creates a metallic sound.

■ Flanger (FLANGER)

This effect adds movement and a strong swelling to the sound.

■ Phaser (PHASER)

This effect adds a bubbly swaying to the sound.

■ Chorus (CHORUS)

This effect mixes the original sound with the effect sound that has fluctuating pitch to add movement and thickness.

■ Distortion (DIST)

This effect distorts the sound.

■ Lo-Fi (LO-FI)

This effect intentionally lowers the fidelity of the sound.

HINT

See the Operation Manual for detailed information about the insert effects.

Filter

The frequency and other parameters can be set for the filter.

■ Type (TYPE)

You can change the filter type.

Peaking Filter (Peaking)

This filter emphasizes a specific range.

High-pass filter (HPF)

This filter cuts low frequencies and allows high frequencies to pass through.

Low-pass filter (LPF)

This filter cuts high frequencies and allows low frequencies to pass through.

Band-pass filter (BPF)

This filter only allows a specific range to pass through.

■ Frequency (FREQ)

This changes the filter frequency.

■ Resonance (RESO)

This changes the amount of resonance.

■ Level (LEVEL)

This sets the level after passing through the filter.

Volume envelope (ADSR)

This sets how quickly the sound starts and how quickly it becomes silent, for example.

■ Attack (Attack)

This changes how fast the sound starts.

This can be set from 0 to 100.

■ Decay (Decay)

This changes how long it takes from the attack to reach the sustain level.

This can be set from 0 to 100.

■ Sustain (Sustain)

This changes the sound level while the pad is being pressed.

This can be set from 0 to 100.

■ Release (Release)

This sets how long it takes for the sound to stop after the pad is released.

This can be set from 0 to 100.

Output mixer (OUTPUT)

This sets the panning (stereo position) and level.

■ Panning (Pan)

The left and right output level balance can be changed.

This can be set from R100 to L100.

■ Level (Level)

The output volume can be changed.

This can be set from 0 to 100.

Editing instruments (continued)

Effect send amount

The amount of sound sent to the master effect can be changed.

■ Send amount (Amount)

The volume sent to the effect can be changed.

This can be set from 0 to 100.

When set to 0, the master effect will not be used.

LED settings

You can set the color used by the Ring Controller LEDs, as well as how pads light when a pad is tapped.

■ Color (Color)

You can select from 32 colors. When set to OFF, LEDs will not light.

■ Animation (Animation)

You can select the animation used when pads are played.

The animation can be set to Off, Moire, Firework, Cross, Circulation or Rainbow.

MIDI settings

Use this to set the MIDI channel for playing instrument sounds by USB MIDI and for outputting playing sequences from the MIDI OUT.

■ Channel (Channel)

If the unit receives a MIDI message on this channel by USB, the instrument assigned to the pad will play at the pitch that corresponds to the note number.

In addition, if a sequence is recorded for the selected pad, note numbers will be output on the set MIDI channel during pattern playback.

This can be set to OFF or from 1 to 16.

The **AR-48** can output sounds for note numbers 0–108.

NOTE

The **AR-48** cannot record MIDI messages received by USB as a sequence.

EFFECT area overview

During the playback of patterns and songs, master effects can be applied to the overall output. Use the EFFECT area to adjust this effect.

Turn the effect ON/OFF.

This lights when the effect is ON. The Ring Controller EFFECT key functions the same way.

Select the effect type.

Select one of the 16 effects. The LED for the selected effect will light.

Effect parameters 1 and 2

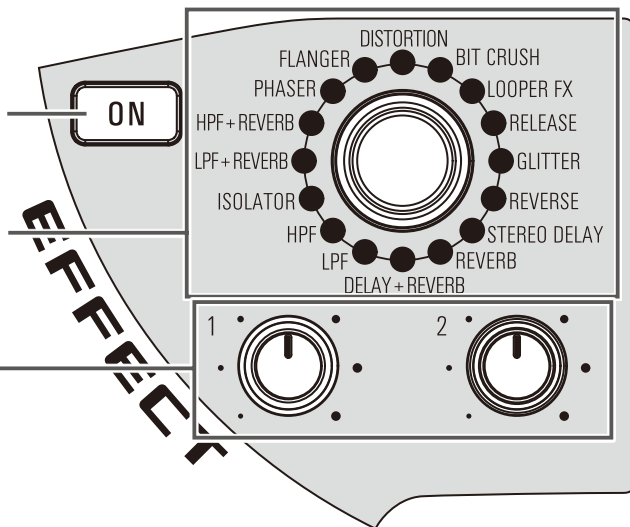

Effect settings

■ Effect list

Category	Type name	Parameter 1		Parameter 2	
		Parameter name	Setting values	Parameter name	Setting values
Filter	LPF	FREQUENCY	20-20000	RESONANCE	0-100
	HPF	FREQUENCY	20-20000	RESONANCE	0-100
	ISOLATOR	LOW	0-100	HI	0-100
	LPF + REVERB	FREQUENCY	20-20000	REVERB MIX	0-100
	HPF + REVERB	FREQUENCY	20-20000	REVERB MIX	0-100
Modulation	RELEASE	TYPE	Brake, Back Spin	SPEED	0-100
	PHASER	RATE	♩ (Type 1)	RESONANCE	0-100
	FLANGER	RATE	♩ (Type 1)	DEPTH	0-100
Distortion	DISTORTION	GAIN	0-100	TONE	0-100
	BIT CRUSH	BIT	4-16	SAMPLE	0-50
Loop/Slicer	LOOPER FX	LOOP LENGTH	♩ (Type 4)	MIX	0-100
	GLITTER	COMPLEX	1-8	MIX	0-100
Delay/Reverb	REVERSE	TIME	♩ (Type 2)	FEEDBACK	0-100
	STEREO DELAY	TIME	♩ (Type 2)	FEEDBACK	0-100
	REVERB	DECAY	1-100	MIX	0-100
	DELAY + REVERB	DELAY MIX	0-100	REVERB MIX	0-100

Note: See Tempo sync parameters for details about ♩ setting values.

■ Tempo sync parameters

When ♩ appears for a parameter or effect, it is a value that can be synchronized to the tempo.

Type 1	Type 2	Type 3	Type 4
32nd note	16th note	32nd note	32nd note
16th note	Quarter note triplet	16th note	16th note
Quarter note triplet	Dotted 16th note	Quarter note triplet	8th note
Dotted 16th note	8th note	Dotted 16th note	Quarter note
8th note	Half note triplet	8th note	Half note
Half note triplet	Dotted 8th note	Half note triplet	4 quarter notes
Dotted 8th note	Quarter note	Dotted 8th note	8 quarter notes
Quarter note	Dotted quarter note	Quarter note	
Dotted quarter note	Half note	Dotted quarter note	
Half note	3 quarter notes	Half note	
3 quarter notes	4 quarter notes	3 quarter notes	
4 quarter notes	...	4 quarter notes	
...	8 quarter notes		
19 quarter notes			
20 quarter notes			

REC/PLAY area overview

Use the REC/PLAY area to control sequences, including playback and recording.

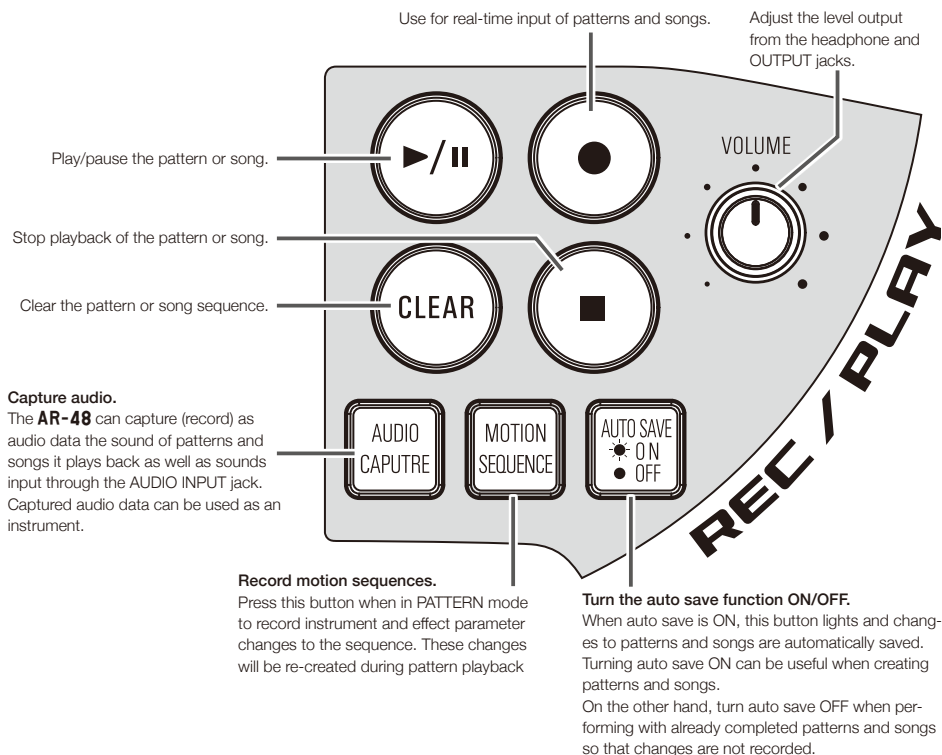

NOTE

- Captured audio data is saved on the SD card. Be aware that you will not be able to use captured recordings if you remove the SD card or replace it with a different SD card.
- The maximum length of captured recordings and audio files that can be added as instruments on the **AR-48** is 6 minutes (or 12 minutes if mono).
- For example, when a one-minute stereo audio file has been assigned, the remaining length of audio that can be assigned is 5 minutes if stereo or 10 minutes if mono.
- If a captured recording or an audio file is used in multiple patterns, this will not change the remaining time for assigning files.
- If the input level is too high, the AUDIO CAPTURE button will flash rapidly. Lower the volume of the connected device or the input level.
- Turning effects ON/OFF, changing parameters, playing pads, and changing patterns, for example, will be recorded while capturing.
- If precount is ON, a click sound will play before capturing starts.
- If the metronome is ON, its sound will play during the capture.

Ring Controller overview

The **AR-48** Ring Controller surface has 16 pressure-sensitive touchpads.

Using these pads, you can input and edit patterns and songs and perform in real-time, for example.

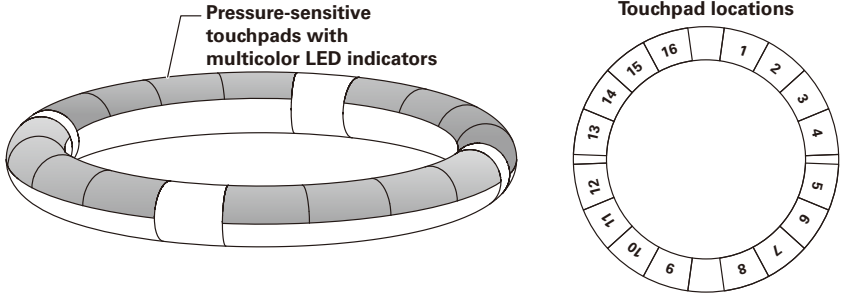

Ring Controller operation buttons

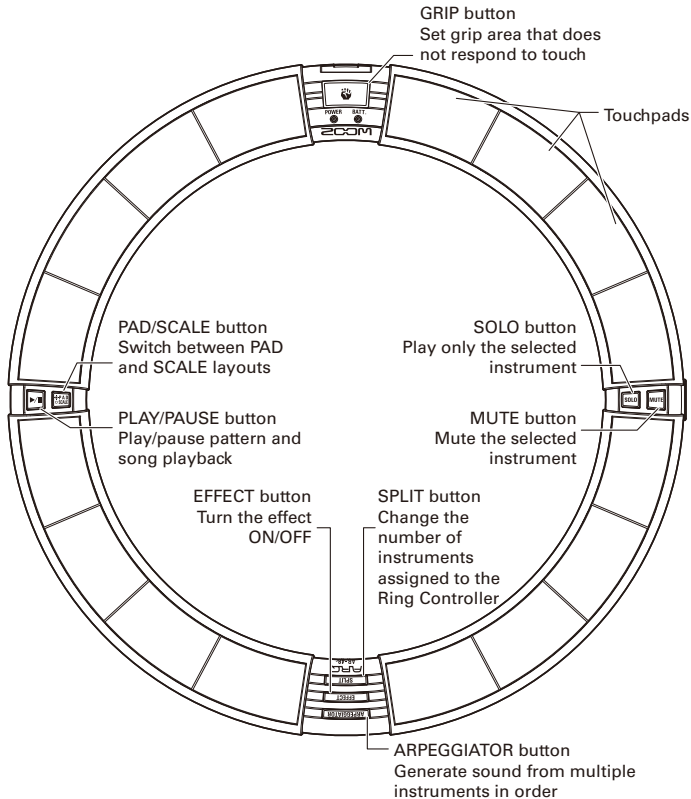

Using the Ring Controller

Arpeggiator

This function can be used to make an instrument play automatically when triggered by a pad. Pressing multiple pads will trigger multiple instruments in order.

By pressing chord tones in SCALE layout, the notes in the chord can be played back one at a time.

■ Operation procedures

1. Turn  to **CONTROLLER**. Press .

The arpeggiator setting screen opens on the SEQUENCE display.



2. Use  to select ON or LATCH.
SWING

This enables the arpeggiator.

When ON is selected, sound will be output automatically while pads are being pressed.

When LATCH is selected, sounds will automatically start output when pads are pressed and stop when their pads are pressed again.



HINT

Automatic output in LATCH mode can also be stopped by pressing .

3. Turn  to change the arpeggiator style.
TEMPO

The STYLE can be set to REPEAT, SEQUENCE, UP, DOWN, UP&DOWN, or RANDOM.

Depending on the selected STYLE, performance types and other detailed settings can be made.

4. If the selected STYLE has parameters 2 and 3, turn  in the SEQUENCE area.

Use  and  to adjust parameters 2 and 3.
SWING TEMPO







Ring Controller overview (continued)

Setting the pad split

When pad layout is selected, you can change the number of instruments assigned to the Ring Controller.

By default, you can play 16 instruments with the Ring Controller. You can, however, also reduce the number of instruments to make it easier to play when performing with it in hand.

1.  Press .  lights, and the number of instruments assigned to the Ring Controller decreases. While pressing , use  in the SEQUENCE area to set the number of assigned instruments to 8, 4, 2 or 1.



2. To cancel the split setting, press

 again.

When  is unlit, the number of instruments assigned to the Ring Controller in PAD layout reverts to 16.

HINT

When the split setting is enabled, the instruments will be assigned to pads in order starting with instrument number 1.

For example, when set to 4, instruments numbered 1–4 will be assigned to pads.

Using the effect

1.  Press .  lights when the effect is ON. After releasing , the effect will stay ON.



NOTE

The LOOPER FX and RELEASE effects will turn OFF after releasing .

2.  Press  again to turn the effect OFF.

Soloing

You can solo the playback of just the selected instrument.

1.  While pressing , tap the pad for the instrument to be soloed.



Only the tapped pad lights, and other instruments stop making sounds.

 stays lit while the solo function is activated.



Muting

You can mute just the selected instrument.

1.  While pressing , tap the pad for the instrument to be muted.

The tapped pad becomes unlit and stops making sound.

 stays lit while the mute function is activated.



NOTE

The solo and mute functions can only be used in PATTERN mode with PAD layout.

Using the grip area

You can set a grip area that does not respond to touch in order to prevent pads from being pressed unintentionally when using the Ring Controller separately from the Base Station.

■ Setting the grip area

1.  Press . All the Ring Controller pads will light blue.
2.  Grasp the area to set as the grip area.

The pads in the grasped range light white and the grip area is set.

Pads outside the grip area can be used as normal.

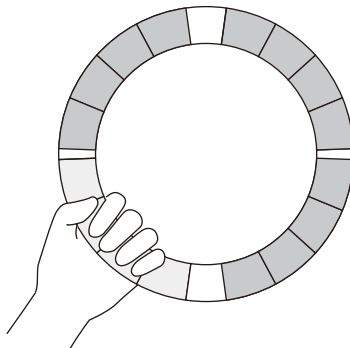

HINT

If a grip is not detected for 30 seconds, detection will automatically cancel.

STEP key setting items

While pressing **FUNCTION**, press a to make a setting.

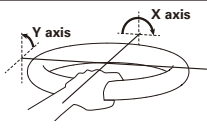
Key	Function name	Function
1	Q:OFF	These set the shortest note length that can be input into sequences. This sets timing correction during real-time input and when input can occur during step input. When FUNCTION is pressed, the <input type="checkbox"/> for the current quantize setting will light.
2	Q:1/32	
3	Q:1/16T	
4	Q:1/16	
5	Q:1/8T	
6	Q:1/8	
7	Q:1/4	
8	Q:1	
9	LEN:1	These set the pattern length. When making a pattern longer, you can also copy the sequence you have already input to the lengthened part. When a pattern is shortened, the already input sequence will not be cleared. When FUNCTION is pressed, the <input type="checkbox"/> for the current length setting will light.
10	LEN:2	
11	LEN:3	
12	LEN:4	
13	SONG TEMPO	Set whether each pattern uses its own tempo setting or all patterns use the same tempo when playing a song. When FUNCTION is pressed, <input type="checkbox"/> -13 will light if the same tempo is being used for the entire song.
14	CAPTURE STOP	Set whether audio capturing automatically stops a set time after starting, and whether captured audio is saved as stereo or mono.
15	COMP	Set the master compressor to increase the sound pressure. When FUNCTION is pressed, <input type="checkbox"/> -15 will light if the master compressor is enabled.
16	AUDIO INPUT	When a signal is being input through the AUDIO INPUT jack, set the input level and the amount sent to the master effect.
17	Metronome output	Set whether the metronome that plays as a guide during recording is output from the OUTPUT jacks. When FUNCTION is pressed, <input type="checkbox"/> -17 will light if it is set to be output from the OUTPUT jacks.
18	Metronome to headphones	Set whether the metronome that plays as a guide during recording is output from the headphone jack. When FUNCTION is pressed, <input type="checkbox"/> -18 will light if it is set to be output from the headphone jack.
19	Metronome volume -	Lower the metronome volume.
20	Metronome volume +	Raise the metronome volume.
21	PRECOUNT	Set whether a precount plays before real-time input and audio capturing starts. When FUNCTION is pressed, <input type="checkbox"/> -21 will light if the precount is enabled.
22	Ring settings	Make Ring Controller settings, including pad sensitivity, LED brightness, aftertouch, accelerometer sensitivity, battery type used, and auto power off.
23	Bluetooth LE setting	If a BTA-1 is installed in the Base Station, on the BLE SETTING screen where devices that can be connected are shown, select and pair a Ring Controller that has a BTA-1 installed.
24	X/Y AXIS	The Ring Controller accelerometer can be used to control arpeggiator timing, effect parameters, and the parameters of the instrument shown on the SOUND display. Parameters can be changed by the movement and tilt of the Ring Controller. Up to three parameters each can be assigned to the movement of the X and Y axes. 
25	BACK UP	The data for patterns and songs created, can be backed up to an SD card. You can save all the data at once or choose only some data to save.
26	LOAD	Backup data created by the AR-48 can be loaded from an SD card. You can load all the data at once or choose only some data to load.
27	SD Format	Check the amount of space used on the SD card or format it. Before using SD cards that have just been purchased or that have been formatted on a computer, they must be formatted by the AR-48 . Be aware that all data previously saved on the SD card will be deleted when it is formatted.
28	SD TEST	Test whether an SD card can be used with the A. A basic test can be done quickly, while a full test examines the entire SD card. Even if a performance test result is "OK", there is no guarantee that writing errors will not occur. This information is just to provide guidance.
29	SD READER	By connecting the A with a computer, you can check and copy data on the SD card loaded in it.
30	CLOCK EXT	Set whether the internal clock or an external clock is used when connected to other MIDI devices by USB. When FUNCTION is pressed, <input type="checkbox"/> -30 will light if external clock is set to be used.
31	MIDI OUT	When the Ring Controller pads and Base Station knobs and buttons are used, the Base Station can send MIDI messages from the USB port and MIDI OUT jack. You can edit the MIDI messages output. The AR-48 will output the set MIDI messages without change even if the mode is switched. These MIDI messages can be used to control DAW software, for example.
32	LCD CONTRAST	Set the display contrast.

Specifications

Base Station

Input	AUDIO INPUT	Connector type	Stereo mini jack (unbalanced)
		Input gain	+10 to -65 dB
		Input impedance	10 kΩ
Outputs	OUTPUT L/R	Connector type	Standard mono phone jacks (unbalanced)
		Output impedance	100 Ω
	PHONES	Connector type	Stereo mini jack (20mW × 2 into 32Ω load)
		Output impedance	10 Ω
Dynamic range			ANALOG IN (AD): 92 dB typ (IHF-A) PHONE OUT (DA): 102 dB typ (IHF-A) MAIN OUT (DA): 106 dB typ (IHF-A)
Recording media			16MB–2GB SD cards, 4GB–32GB SDHC cards, 64GB–512GB SDXC cards
MIDI IN/OUT			MIDI OUT (5-pin DIN jack) and USB MIDI
Power			5V 1A AC adapter (AD-14)
Power consumption			Base Station: 2 W maximum When powering Ring Controller: 3 W maximum
External dimensions			259.0 mm (D) × 257.6 mm (W) × 63.0 mm (H)
Weight (unit only)			1123 g
Displays			128×32 dot-matrix LCD × 2
Interface	Type B USB 2.0 MIDI class/ mass storage class operation	Supported operating systems	Windows 7 (SP1 or later), Windows 8 (including 8.1) or later, Windows 10 Mac OS X 10.8 or later
		Minimum specifications	Chipset that includes USB 2.0 as standard, Intel Core i3 or faster CPU
	Type A USB 2.0 MIDI class operation		For Ring Controller connection

Ring Controller

Sensors			PAD pressure sensors, 3-axis accelerometer
Power			USB bus power
Batteries			2 AA alkaline or rechargeable nickel-metal hydride (NiMH) batteries
Battery operation time			About 8 hours (when BTA-1 installed)
Power consumption			1 W maximum
External dimensions			280.2 mm (D) × 278.8 mm (W) × 29.7 mm (H)
Weight (unit only)			416 g
Trigger pads		Number of pads	16
		Velocity curves	4 types
Interface	Type B USB 2.0 MIDI class/ mass storage class operation	Supported operating systems	Windows 7 (SP1 or later), Windows 8 (including 8.1) or later, Windows 10 Mac OS X 10.8 or later
		Minimum specifications	Chipset that includes USB 2.0 as standard, Intel Core i3 or faster CPU
	MIDI over BLE (when BTA-1 installed)	Supported iOS devices	Devices using iOS 8.0 or later
		Supported Macs	MacBook, iMac and Mac pro series computers that use Mac OS X 10.10.5 Yosemite or later and support BLE transmission



ZOOM CORPORATION

4-4-3 Kanda-surugadai, Chiyoda-ku, Tokyo 101-0062 Japan

www.zoom.co.jp