

***MESA/BOOGIE***



***Owner's Manual***

## *Greetings from the Home of Tone*

*Congratulations on your choice of the ROADKING as your Guitar amplifier and welcome to the MESA/Boogie family! As a discriminating player you probably know that you have purchased the most comprehensive instrument for amplifying Guitar that is available. What you might not realize is that this entitles you to all the experience, resources and commitment our twenty-five years of service to musicians world wide has to offer. Our responsibility is to help you sound great! So, if at any time you feel you need help or direction, we are here for you...a phone call away.*

# ROAD KING

## Table of Contents

Precautions	0
Overview	1-2
Getting Started	3
Helpful Hints	3-4

### FRONT PANEL:

MODES: Ch 1 & 2 Clean	5
Ch 1 & 2 Fat	5
Ch 1 Tweed	5
Ch 2 Brit	6
Ch 3 & 4 Raw	6
Ch 3 & 4 Vintage	6
Ch 3 & 4 Modern	7

### CONTROLS:

GAIN	7
TREBLE	8
MID	8-9
BASS	9
PRESENCE	9
MASTER	10
OUTPUT CONTROL	10-11
SOLO CONTROL	11
HI VOLTS & AC MAINS SWITCHES	11

### REAR PANEL:

SLAVE	12
SPEAKER OUTPUT BANK A+B - Cabinet Switching	12
REVERB	13
CHANNEL STRIPS	13
PROGRESSIVE LINKAGE	13
SELECTING POWER TUBE ARRAY	14-19
RECTIFIER SELECT with TUBE-TRACKING	20
SPEAKER A/B & A+B SELECT SWITCH	21
FX LOOP SWITCHES & CONTROLS	21
TUNER MUTE	21
FX LOOP & PATCHING and EXTERNAL SWITCHING	22-23
POWER: SPONGY & BOLD	23
FUSE and SERIAL NUMBER	24
FACTORY SAMPLE SETTINGS	25-28
DIAGNOSING TUBES & TUBE MAINTENANCE	29-33
SPEAKER HOOK-UP & IMPEDANCE MATCHING GUIDE	34-39
FEATURE ARTICLE: Irishmen, Pentodes & Triodes by Randall Smith	40-42
TUBE LAYOUT & PARTS SHEET	43-44

## **IMPORTANT SAFETY INSTRUCTIONS**

Read these instructions.

Keep these instructions.

Heed all warnings.

Follow all instructions.

Do not use this apparatus near water.

Clean only with dry cloth.

Do not block any ventilation openings. Install in accordance with the manufacturer's instructions.

Do not install near any heat sources such as radiators, heat registers, stoves, or other apparatus (including amplifiers) that produce heat.

Do not defeat the safety purpose of the polarized or grounding-type plug. A polarized plug has two blades with one wider than the other. A grounding type plug has two blades and a third grounding prong. The wide blade or the third prong are provided for your safety. If the provided plug does not fit into your outlet, consult an electrician for replacement of the obsolete outlet.

Protect the power cord from being walked on or pinched particularly at plugs, convenience receptacles, and the point where they exit from the apparatus.

Only use attachments/accessories specified by the manufacturer.

Unplug this apparatus during lightning storms or when unused for long periods of time.

Refer all servicing to qualified service personnel. Servicing is required when the apparatus has been damaged in any way, such as power-supply cord or plug is damaged, liquid has been spilled or objects have fallen into the apparatus, the apparatus has been exposed to rain or moisture, does not operate normally, or has been dropped.

To insure proper ventilation always make sure there is at minimum four inches (101.6mm) of space behind the rear of the apparatus. The ventilation should not be impeded by covering the ventilation openings with items, such as newspapers, tablecloths, curtains, etc. Do not impede ventilation by placing objects on top of the apparatus which extend past the rear edge of its cabinet.

No naked flame sources, such as lighted candles, should be placed on the apparatus.

The apparatus shall not be exposed to dripping or splashing and no objects filled with liquids, such as vases, shall be placed on the apparatus.

**WARNING:** To reduce the risk of fire or electric shock, do not expose this apparatus to rain or moisture.

The AC plug is the mains disconnect. The plug should remain accessible after installation.

**WARNING:** EU: permission from the Supply Authority is needed before connection.

**WARNING:** Always make sure proper load is connected before operating the amplifier. Failure to do so could pose a shock hazard and may result in damage to the amplifier.

Do not expose amplifier to direct sunlight or extremely high temperatures.

Always insure the amplifier is properly grounded. Always unplug AC power cord before changing fuse, tubes or removing chassis. Use only same type and rating when replacing fuse.

Avoid direct contact with heated tubes. Keep amplifier away from children.

To avoid damaging your speakers and other playback equipment, turn off the power of all related equipment before making the connections.

Do not use excessive force when handling buttons, switches and controls. Do not use solvents such as benzene or paint thinner to clean the unit.

Always connect to an AC power supply that meets the power supply specifications listed on the rear of the unit. Export models: always insure unit is wired for proper voltage. Make certain grounding conforms with local standards.

**YOUR AMPLIFIER IS LOUD! EXPOSURE TO HIGH SOUND VOLUMES MAY CAUSE PERMANENT HEARING DAMAGE!**

*Your Mesa/Boogie Amplifier is a professional instrument. Please treat it with respect and operate it properly.*

**READ AND FOLLOW INSTRUCTIONS OF PROPER USAGE.**



## Operating Instructions

### Overview:

Congratulations on choosing the *Mesa Dual Rectifier Road King* as your amplifier and welcome to the *Mesa/Boogie* Family! By choosing this all-tube hand-built instrument you have taken a step into the future of guitar amplification, for as you can see at a glance, the *Road King* is more than just an amp. It's a *collection of amps* housed in one chassis that we refer to as an Advanced Amplifier Array. This arsenal of sounds is so powerful that with them at your command, inspiration will take over and propel your playing to places you have only dreamed. Let's take a moment and review the features that make up this house of tone.

First and foremost it will help you to digest this dictionary of amazing guitar sounds by realizing that, as daunting as it looks, it is really just four separate amps. If you view it as such and learn them individually and *then* combine and dedicate them, you will find the process easier. Each Preamp Channel on the Front Panel has a corresponding Power Amp/Effects Loop Control Panel on the Rear Panel (we call them Channel Strips). Once you have chosen a Channel/Mode combination for a sound, you simply go to the Rear Panel and select that Channels' power amp choice (any 1 of 5 selections), choose your Rectifier Style and program your Effects Loop choices. There you go, one channel done...repeat this scheme three more times and you are ready to explore your first palate of sounds in the *Road King*. Rest assured, many more combinations are lurking in there and you can look forward to years of discovery as you go deeper. In case that was too simple sounding, here is a more expanded way of understanding the *King*

Four independent preamp channels make up the front end of the *Road King* and though they may each be used for any sound, they are grouped as two sets of lower gain Rhythm Channels (1 & 2) and two sets of high gain Lead Channels (3 & 4). The two sets are stacked with the lower gain rhythm channels following the Input jack. Each of these channels house 3 different modes, which are voiced differently and in certain cases have different gain structures. You'll notice the modes are duplicated in the two types of channels (excepting one in each Rhythm Channel) which makes it possible to use the them for different settings of the same sound.

### FRONT VIEW : COMBO *Road King*

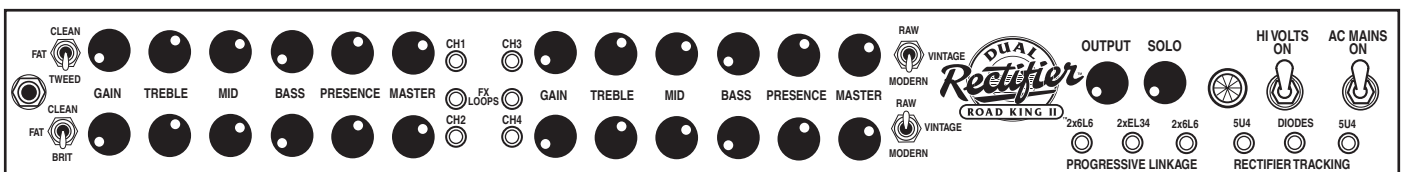

### REAR VIEW : COMBO *Road King*

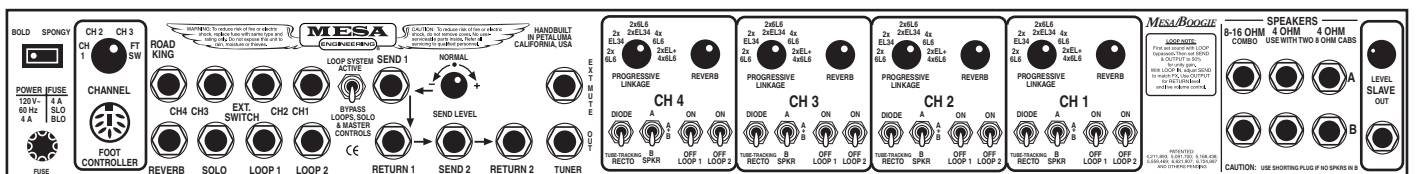

## Overview: (Continued)

This allows the *Road King* to be many amps to many players and roam confidently between extremely different musical styles while retaining the ability to focus in on any one and offer a multitude of great sounds for a specific genre. For example, a Blues player might dial up 1 & 2 for different clean sounds using the same mode for both chording and solo fills, while 3 & 4 provide different levels of the same lower gain solo sound. Conversely, a Rock player might configure 1 & 2 for semi-clean and pushed rhythm sounds respectively and dedicate 3 & 4 to high gain crunch rhythm and lead sounds using different settings of the same modes.

This type of preamp versatility means you will never have to compromise, even when you change bands or venture into a new and different style with your playing...and you've chosen an amp that will grow with you.

This awesome preamp power is then sent to the *Road Kings'* Effects Loop section and we have provided two Series Loops to assure a match to whatever type of processing you choose. These may be used individually or combined, and may be programmed active in any of the channels or, footswitched in and out on the fly.

From there we reach the coolest feature of all and the reason why the *Road King* is just that...our patented Progressive Linkage switchable, and in this case assignable, power section. That's right, any of the 4 preamps can be combined with any one of the 5 power section configurations! Your choices are the bubbly, elastic 2 x 6L6; the urgent, brash 2 x EL34; the tight, bold 4 x 6L6; the elusive, stinging 2 x 6L6 + 2 x EL34; and the huge, dominating power of 4 x 6L6 + 2 x EL34.

Each of these power configurations lends its own personality and when matched with the right preamp can sonically define a musical style. But it doesn't end there...the *Road King* also features Rectifier Tracking, a feature which automatically matches the type of rectification for each of the preamp / power sections you have configured. This means you can tune the power feel even further to the sound you are creating. You might want a lower wattage clean sound with the loose, airy feel of Tube Rectification and a high gain lead sound with higher power and the tight tracking bass response of the Solid State rectifier or vice versa. Many combinations are possible and the best part is that Rectifier Tracking follows your choices in power sections to always mate the proper amount of rectification for a given string of tubes. For example, if you are using either 2 x 6L6 or 2 x EL34 and you choose Tube rectification, 1 x 5U4G will be applied. If you use either 4 x 6L6 or 2 x 6L6 + 2 x EL34 2 x 5U4G will be used. And finally, if you choose to run all six power tubes (4 x 6L6 + 2 x EL34) then the Silicon Diodes will be called up, ensuring that you have maximum headroom at all times. This Rectifier Tracking feature provides one more layer of focus to an already mindbending array of sounds to create the most expressive amplifier available anywhere.

And if this versatility isn't enough, add to the palate Programmable Channel-specific Speaker Switching! That's right, you can utilize two different types of speaker enclosures to enhance different sonic characteristics and combine these choices with each Channel/Mode scheme. Use an open back 2 x 12 cabinet for more shimmering clean performance and switch to a closed back 2 x 12 for a bigger, more compressed lead sound. There are even provisions for using two cabinets of different impedance loads...the choice is yours.

The *Road King* incorporates a rich, all tube analog Reverb. Controlled per channel with the Rear Panel Reverb controls, it may be switched in and out via the *King Kontroller*.

Our SOLO feature is an additional Output Level control that is wired in parallel to the Output and provides a pre-assignable, footswitchable boost for stepping out when it's time to solo.

A built-in Variac, our patented SPONGY/BOLD switch, is also included which enables you to reduce the A.C. line voltage for a looser feel and increased upper harmonic spread resulting in that *brown* sound that has the elusive sag.

And finally, to keep you in constant control of all the features aboard this vehicle of expression, we have supplied one of the mightiest footswitches around...the *King Kontroller*. All possible Channels, Functions and Features are there for your instant access and their status is monitored by LED illumination.

So with an overview of the basic layout of the *Road King* behind us, let's get ready to play.

## Getting Started:

---

- 1.) After unpacking the amplifier remove the plastic webbing from all of the tubes (including the preamp tubes behind the row of power and rectifier tubes) and make sure all tubes are seated firmly in their sockets.
- 2.) Install the 5U4 Rectifier tubes (if they are not already in place) by bending back the spring steel tube clamps just enough so that the base of the tube will have to barely push the clamps out of the way as they go in. Be sure to line up the guide with the slot in the socket, don't force it...when it is lined up it will fit in the socket easily. When the tube is lined up gently press the tube into the socket while rocking it back and forth until it is seated.
- 3.) Connect the 8 Pin DIN Footcontroller Cable to the female DIN connector located on the Rear Panel just under the Rotary Mode Select Switch.
- 4.) Connect your speaker enclosure(s) to the proper impedance SPEAKER OUTPUT jacks "A & B". If only one speaker cabinet is to be used make sure that the dummy plug connected to the chassis is connected to the "B" jack to prevent accidental output transformer damage due to a "no load" scenario.
- 5.) Connect the A.C. Power Cable to a grounded A.C. outlet.
- 6.) Flip the A.C. Mains switch to the ON position and wait at least 30 seconds for the power tube filaments to warm up with the HI VOLTS switch in the down position. This cold start procedure prolongs tube life so try to follow it each time you power up the amplifier.
- 7.) Turn the Front Panel OUTPUT control to zero before flipping the HI VOLTS switch to the ON position. This will prevent accidental settings that are too loud for the room and your ears. These amplifiers are LOUD and are capable of extreme volumes and should be used with care to avoid damage to your hearing. Starting each power up with the OUTPUT control zero-ed help to eliminate painful and/or embarrassing situations.
- 8.) Flip the HI VOLTS to the ON position and enjoy your new realm.

## Helpful Hints:

---

- 1.) The Rear Panel CHANNEL SELECT Rotary switch must be set to FOOTSWITCH to access either Channels or features via the footcontroller.
- 2.) **The OUTPUT and SOLO controls work only if the Effects Loop is active.** Switch out of the LOOP BYPASS position in the EFFECTS LOOP section of the Rear Panel.
- 3.) Should you select a Channel when the Cabinet Switching Feature is not being used and experience either low output or a broken-up or distorted signal, or no signal at all... Check that the SPKR ASSIGN mini toggle in that Channels' Strip is not assigned to SPKR "A + B" or "B".
- 4.) The SOLO Control is activated when the Footcontroller is connected to the FOOTSWITCH jack on the Rear Panel and the Effects Loop is taken out of LOOP BYPASS and activated. When the Footcontroller is not connected the SOLO control will have no effect on the signal.
- 5.) The SOLO feature can be used to set a volume level above that of the OUTPUT control setting. It will not allow a setting below that of the OUTPUT control.

## Helpful Hints: *(Continued)*

---

- 6.) The GAIN and TREBLE controls are the most powerful controls in all four channels. They should be used with taste and you will find that many of the best sounds are found with the controls set somewhere in their middle regions. Avoid setting the TREBLE above 2:00 when the GAIN is maxed as the possibility of unwanted noise and squealing from microphonic tubes increases dramatically above this setting.
- 7.) You will notice a substantial volume increase when switching from either the RAW or VINTAGE modes to the MODERN mode in Channels 3 & 4. When switching modes Always check your MASTER controls to avoid sudden volume increases. It is a good practice when setting up your channels, to get in the habit of zeroing out the Channel MASTER control each time you switch modes.
- 8.) The PRESENCE control determines alot about the voicing of gain sounds. Set lower it will fatten and compress single note sounds and lend a liquid feeling to the strings in the 3 modes of Channels 3 & 4. Set higher it will add cut and brightness to the sound and can be useful in keeping Bass response tight, especially at high GAIN settings when searching for crunch rhythm sounds.
- 9.) **Always keep the dummy shorting jack connected to the “B” SPEAKER OUTPUTS** when you are not using two sets of cabinets for Cab Switching. This will protect the output transformer from damage should signal accidentally be sent to the “A+B” or “B” OUTPUTS via the SPKR Program switch.
- 10.) **Although Channels 3 & 4 contain duplicate modes, the PRESENCE controls are different and therefor settings and sounds will not dial up exactly the same. CHANNEL 3 has been optimized for the RAW and VINTAGE modes** with a PRESENCE control that peaks just above “very bright” and at the low end of the control gets truly round and squashed. This response showcases the more warm and furry nature of these two modes. **CHANNEL 4 houses a much more powerful PRESENCE control that has been optimized for the MODERN mode and will go to realms of top end that are frankly ridiculous.** However, up to the 2:00 region its’ more unbridled response makes the Recto MODERN mode a force to reckon with. Think of the difference like this; **the entire range of CHANNEL 3’s PRESENCE control can be found below 10:00 on Channel 4’s PRESENCE control.** It plays out like this; using MODERN IN Channel 3 will require a PRESENCE setting at the top of the range and conversely, using RAW and VINTAGE in CHANNEL 4 will require a very low PRESENCE setting.

**NOTE: CHANNELS 3 & 4:** *Should you find that you favor RAW and VINTAGE and never need the aggressiveness of MODERN. Or the opposite, you favor the shredding cut of MODERN and have no use for the warmer nature of RAW and VINTAGE, it is possible to duplicate the PRESENCE controls in CHANNELS 3 & 4 with a simple pot value change. However, before you call and have us send you the part, we strongly recommend working with the two channels as they are. Much thought was put into how to maximize the modes for the best performance under a broad range of styles. By spending some time exploring you may find that you come to love, and actually rely on, sounds you thought you had no use for. Such is the beauty of an amp that is capable of so much diversity.*

14. When switching Channels with Reverb applied or switching the Reverb itself in and out of the signal path with the Footcontroller, it is normal to experience approximately 1-2 seconds of delay before the Reverb effect is mixed back in with the dry signal. See NOTE: under REVERB in the Rear Panel section of this manual for more info.

Now that we have shared a few hints to make things easier, let’s take a look at the controls and modes.



# CHANNEL MODES:

## CHANNELS 1 & 2: CLEAN

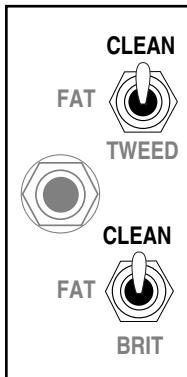

This is the lowest gain circuit of the *Road Kings*' twelve modes and is optimized for producing balanced pristine clean sounds. This mode is duplicated in CHANNEL 2 as it is extremely useful for many different applications. For the best understanding of how to achieve a great sound in this mode, please refer back to the GAIN control section of this manual. However, a great place to start is 12:30 or so on the GAIN control with more sparkle available below this and more warmth apparent above...from there adjust according to your guitars individual response.

Because of its more traditional architecture this mode also works extremely well for vintage style drive sounds. By turning the gain all the way up, a beautiful old school solo sound is possible...especially with neck single coil pick-ups. The TREBLE and MIDDLE controls can also add gain and sustain to this sound ( reduce Presence to blend highs ), but you will probably want to run the BASS control below 10:30 to avoid flubbiness and preserve a focused attack.

## CHANNELS 1 & 2: FAT

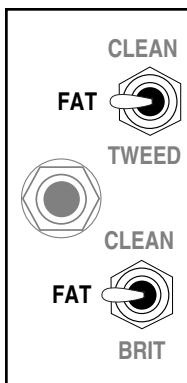

This mode comes from our original *Mark 1 Boogie* and puts emphasis on the low mid and bottom end and as a result the top strings of the instrument have more girth and width. This mode is duplicated in CHANNEL 2 is very useful for a variety of sounds. The difference is wonderful for clean single note soloing where you need more body and warmth behind the notes. Because this mode is very different from the CLEAN mode, it requires that you reset the controls for balance. We suggest running the BASS control a couple notches lower, especially for chording.

It also helps to use the GAIN controls' tonal influence (refer to GAIN in the controls section of this manual) to achieve the best results with this mode. We like to set the GAIN somewhere between 10:30 and 12:00 for chording as this brings out the sparkle and improves the headroom.

For single note clean soloing you can run the GAIN up around 1:00 – 2:00. If you are going for a pushed rhythm sound with the GAIN all the way up, you will likely have to run the BASS below 9:30 to avoid flubbiness and boom.

## CHANNEL 1: TWEED

This mode appears in CHANNEL 1 only and is a variation on the CLEAN that appears in both channels. Here we have emphasized the elastic, bouncy character of the low gain clean circuit to achieve a more vintage feel that has an element of sag built in. This mode feels easier to play and you would swear there is less resistance on the strings...almost as if you were using a lighter gauge set of strings, but it is just our treatment of the signal.

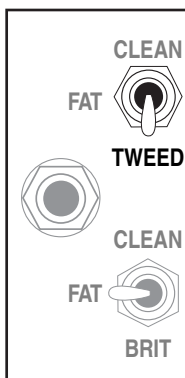

This characteristic can be enhanced even further by assigning this mode to the 2 x 6L6 power section in CHANNEL 1's Channel Strip. The bubbly nature of this lighter, brighter power feel mates perfectly with the **TWEED** mode enhancing what is already a rubber band joy-ride to achieve one of our favorite sounds in the entire amp.

And if you like this approach to clean sounds, be sure to check the beyond vintage feel by taking this scheme a step further and selecting SPONGY on the A.C. POWER SELECT switch and knocking the A.C. down for a truly soupy vibe. Whether you choose to utilize **TWEED** for these lower headroom retro applications or, you want a high headroom sound with just a bit more resiliency, this mode is a wonderful voice for any style of clean playing.

# CHANNEL MODES: *(Continued)*

**CHANNEL 2: BRIT** This mode appears in CHANNEL 2 only and, as the name implies, was inspired by the great sounding amps of the 50's & 60's that were built in Great Britain. These classic amplifiers were basically "upside down Leo circuits" but none the less had a signature sound all their own, due largely to the fact that they were powered by the pentode available to them at the time...the Euro style EL 34. This difference, along with minor value differences in the circuit, created a very different sound than the tweed and black face amps born in the United States.

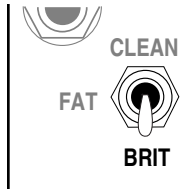

We have combined all the great qualities of several of these classic circuits to arrive at a sound that is pure teabag. With emphasis on a lower region of Treble and more punch in the low mids, this mode is truly different than the other modes in CHANNEL 1 & 2. It works extremely well for both chording and single note soloing with its thicker, throatier nature. It also lends itself well to clipped sounds, with its less extended top end and wider mid section, producing some of the coolest crunch rhythm sounds around.

Needless to say, the 2 x EL34 power section was born to serve this mode and when these two parts are used together a level of character is unveiled that is the natural equivalent opposite to TWEED feeding the 2 x 6L6 power harness. **BRIT** also works very well with the combination power sections of 2 x 6L6 + 2 x EL34 and 4 x 6L6 + 2 x EL34. These two schemes are great if you want the more urgent character of the EL's but need more headroom than they are capable of providing by themselves. The choice is yours as to how best to use this very cool and different mode and we feel sure that, no matter how you decide to dedicate your clean channels, you will find the **BRIT** mode an awesome addition to your bevy of sounds.

**CHANNEL 3 & 4: RAW** This new *Road King* mode is the lowest gain of the three in the two high gain lead channels. Its less saturated nature greatly enhances the already versatile bag of sounds the two original lead channels offered. The range of gain available covers an extremely wide spectrum and it can be set to double as a formidable alternate clean mode, a low gain purring blues sound and beyond, all the way up to a grinding crunch or searing solo sound.

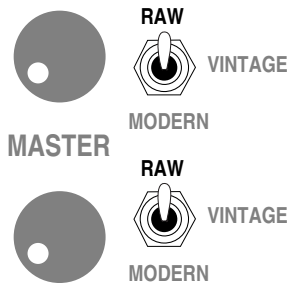

The TREBLE can be set relatively high (2:00) to add a little more gain and shred when using **RAW** for certain crunch rhythm sounds and keep in mind CHANNEL 4 is capable of more aggressive sounds due to its more extreme PRESENCE control taper. Don't overlook the amazing medium gain soloing potential **RAW** offers in CHANNELS 3 & 4 where, because of the PRESENCE controls more gradual response, a wider range of voice-like single note sounds appear that benefit from this more compressed character.

**CHANNEL 3 & 4: VINTAGE** This high gain mode is the famous liquid *Recto* voice and it can be found in its original state in CHANNELS 3 & 4. Its lush harmonic content and fat creamy feel has found its way onto so many recordings, it is now a staple for anyone headed to the studio for an album project. Combining this super juicy, expressive preamp with the *Rectos'* black magic, tube-rectified power section creates colors in gain that most players find truly addictive. Single note solo work is effortless as the strings become easy to play with **VINTAGE** modes musical and natural tube compression. Spend time learning the lower regions of the **VINTAGE** mode as the overlap between RAW and **VINTAGE** is a place where many beautiful sounds lie.

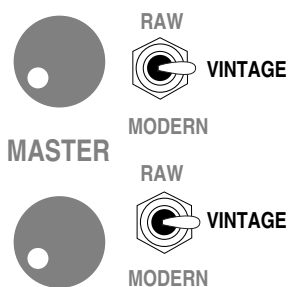

These two modes are similar enough when **VINTAGE** is set in its lower range and RAW is set in its medium to higher range and yet, each posses a character that is unique and identifiable. Remember that you can swap channels to achieve different voicings of the **VINTAGE** sound and no matter which you settle upon, you will likely find your trademark lead sound lurking somewhere in this sea of liquid gain.

## CHANNEL MODES: (Continued)

### CHANNEL 3 & 4: MODERN

Aggressive. This is the word that best describes the menacing power of the *Road Kings*' most rebellious of all modes and appears in its original form in CHANNELS 3 & 4. A take no prisoners, crushing assault of top end cut and lightning fast response creates a sound of unparalleled aggression that has set a new standard for hard core sounds.

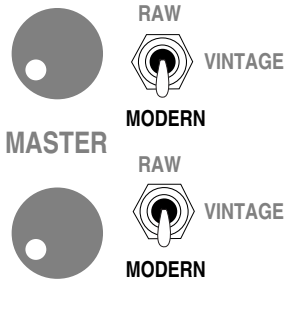

The added tightness of the low end response combined with the radically more present top end keeps the **MODERN** mode tracking accurately even at extreme gain settings. Keep in mind that when using **MODERN** in CHANNEL 3 you will have to run the PRESENCE control almost all the way up to approach the lower range of the PRESENCE control in CHANNEL 4.

This lack of extreme top end can be a benefit when searching for single note solo sounds in the **MODERN** mode as the more compressed nature of this tamer presence range in CHANNEL 3 tends to warm things up.

## CONTROLS:

**GAIN:** This control adjusts the predominant gain stage in each channels' circuit with the function and taper being optimized for each individual channel. Remember that your *Road King* is really three separate multi-mode amplifiers built onto one chassis, so though each channel looks identical, the **GAIN** control for each channel comes in a different place and adjusts a different point in that channels circuit.

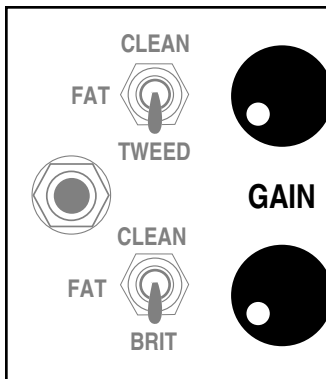

In most guitar amplifiers, and especially in all-tube circuits, the **GAIN** control is the most powerful control in the preamp. It shapes the overall style and character of the sound and is responsible for whether the sound is clean, overdriven or anywhere in between. In your *Road King*, the **GAIN** control is even more powerful. It not only determines the amount of drive, but also acts as an integral part of the tone control string as well.

To simplify the **GAIN** controls' role in shaping the overall tone of the sound we will look at it in two ways - **1**; alone and **2**; in conjunction with the tone controls.

### 1) By itself the GAIN control has basically three tonal regions -

**Low ( 7:00 - 11:00 )** provides the cleanest, least saturated sounds and in this region the sound will be brighter and contain more upper harmonics lending a three dimensional character to the sound.

**Middle ( 11:15 - 2:00 )** enhances the saturation and replaces some of the upper harmonics with a richer, warmer quality and a fuller bottom end response. Not yet fully saturated, this region is the easiest place to get a great sound in all three channels. This region contains many of the *Road Kings*' best sounds...especially for soloing due to the crucial blend of an expressive attack combined with ample sustain.

**High ( 2:15 - 5:00 )** saturates the signal and enhances low and low mid frequencies. While this region provides the maximum saturation and therefor sustain, it also compresses and softens the attack characteristics. For this reason we suggest using this higher region of the **GAIN** control sparingly and only when maximum sustain is needed.

## CONTROLS: (Continued)

**NOTE:** Due to the *Road Kings'* extreme gain potential, the highest regions of the **GAIN** control may possibly push the pre-amp tubes past what they can handle, producing microphonic squealing. While we screen and test the tubes your amplifier was shipped with and the tubes in your amp passed our rigorous test, we can't predict how the tubes will respond over time exposed to extreme gain settings. Your tubes are warranted for a period of 6 months under normal use, but you can save yourself the present and future inconvenience of having to deal with annoying microphonic tube problems by simply using **a little common sense...Don't turn the Gain all the way up!**

If you must for a specific part or at very low volumes, back down the **TREBLE** and **PRESENCE** controls. Your *Road King* was designed to provide amazing gain and tone at less than extreme settings removing the need for you to crank everything all the way up. If you are not able to achieve the sound you want at sensible settings on any or all of the controls, your problem may lie elsewhere in the signal chain, i.e. pick-ups, cabinetry, processing etc. Keep in mind you can always call on one of our product specialist Monday through Thursday and seek some advice should you find yourself struggling to get the sound you want.

**2.) GAIN - In conjunction with the Tone controls** - Basically, a simple rule applies...as the Gain is increased the Tone control string has less and less effect on the signal until at 5:00 the signal is so saturated that you are *getting mostly Gain and very little Tone*. Again, this is the reason we suggest using the **GAIN** control in its middle region. Here the Tone control string is very active and provides maximum shaping power - allowing you to dial virtually any sound you desire.

**TREBLE:** As in most tube guitar amplifiers, the **TREBLE** control ( in all four channels of your *Road King* ) is the most powerful of the rotary controls and is next in line only to the **GAIN** control as a shaping tool. Because it is first in the signal path of the tone controls - and from here the Middle and Bass receive their signal - it is by far the dominant tone control. For this reason the setting of the **TREBLE** control is very important for equal representation of the three frequency regions to appear at their respective controls.

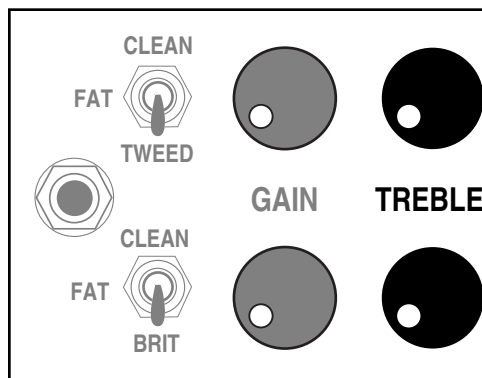

Like most of the controls on your *Road King*, there is an optimum region of the **TREBLE** control where ample top end is mixed in and yet enough signal is still passed on to the **MIDDLE** and **BASS** controls.

As you might surmise, here is the *sweet spot*. There are definitely great sounds above and below this middle region ( 11:00 - 1:30 ), but the balance between the **TREBLE** control and the other two tone controls is compromised.

The one place you may want to throw caution to the wind and set the **TREBLE** control above this median zone presents itself in **CHANNEL 1** of your new *Road King*. In all 3 modes ( **CLEAN**, **FAT** & **TWEED** ), the **TREBLE** control can be used to dump extra gain into the mix. This is especially effective in the **TWEED** mode for crunch sounds. When doing so use the **PRESENCE** control to roll off some of the more than ample top end for a more compressed feel and fatter voice. As you might surmise, the **BASS** controls' effectiveness will be reduced, so you may have to run a much higher setting than you are used to seeing to achieve a balance. This said, keep in mind that the **TREBLE** control in Channel 1 **TWEED** should not be set much above 2:30 to avoid unwanted microphonic tube problems.

**MID:** The **MID** control is responsible for the blend of midrange frequencies in the mix and though its effect is not as dramatic as that of the **TREBLE** control, it plays an integral part in achieving any sound in your *Road King*. It is capable of changing the feel dramatically as it blends in a group of frequencies that tend to soften or stiffen the way a sound feels to play.

Most players tend to lean in the direction of lower **MIDDLE** control settings ( 7:00 - 11:00 ) where a scoop in this region produces *girth* ( by letting the Bass become a little more dominant ) and a lack of punch lends a more compressed, *even* feel to the strings and therefore less apparent resistance to the pick. As the **MIDDLE** control is increased, ( 11:30 - 1:30 ) the sound is rounded-out and

## CONTROLS: (Continued)

**MID:** (Continued) filled-in with a focused mid attack appearing rather quickly. As you would guess, the feel starts to change - becoming more resistant. Above this region the **MIDDLE** control could be used to compensate for either weaker pick-ups or for times when a specific deficiency is produced by either an extremely high setting of other tone controls, or a physical anomaly in the room. While these **MIDDLE** control settings ( 2:00 - 5:00 ) can introduce added gain and create enhanced focus, the trade-off will be a stiffer, more forward, less compressed feel.

**CHANNELS 1 & 2 utilize a different MIDDLE control than that of the CHANNELS 3 and 4** with a custom-designed taper and value. In its low range ( below 12:00 ) it functions as a normal midrange control with a taper suited to blending fine increments of these frequencies. Most players lean toward a fairly radical scoop ( 7:00 - 10:30 ) for clean playing, preferring to let Treble and Bass remain dominant, thus producing the signature sparkle and breath essential for a pristine clean sound.



TREBLE

MID



As the **MIDDLE** control in CHANNELS 1 & 2 are swept past 1:00, it quickly starts to add gain in these midrange frequencies adding cut and punch. As the top end of the control is reached, ( 3:00 - 5:00 ) it becomes an additional *gain control* capable of taking both CLEAN and TWEED modes to extremes. Experiment with this cranked region in conjunction with conservative settings of the other tone controls to balance both sound and feel. While this added flexibility may make CHANNEL 1 & 2 **MIDDLE** control a little more tricky to learn at first, it will become quite valuable as you start to realize the power of this super versatile channel.

**BASS:** This control works similarly in all four channels in that it determines the amount of low frequencies present in a sound. However, the actual frequencies and *style of lows* it mixes in changes from channel to channel. Like the **MIDDLE** control, it falls in line signal-wise *after* the **TREBLE** control and the same scheme applies. When the **TREBLE** control is set high, the effectiveness of the **BASS** and **MIDDLE** controls is reduced. If the **TREBLE** control is set low these two controls become dominant.



MID

BASS



For the most balanced sound and a balance of power between the three rotary tone controls, try to use the **TREBLE** control in its middle ranges. This scenario produces nearly equal representation of all the frequencies on the tone controls and provides a great neutral starting point for further tweaking.

**PRESENCE:** The **PRESENCE** control is a high frequency attenuator that is placed at the end of each channels pre-amp stage and affects frequencies higher than those of the **TREBLE** control. It acts independently of the other rotary tone controls and is crucial in voicing the Channel. It is a powerful global tone control. Lower **PRESENCE** control settings darken and, in fact, compress the signal which works well to fatten single note solo sounds, giving them girth and focus. Some of the best lead sounds in your *Road King* will find the **PRESENCE** control in its lower regions, where a balanced, vocal response is achieved.



BASS

PRESENCE



Higher settings unleash the mighty roar of your *Road King* and this can be great for sparkling clean sounds in Channels 1 & 2 and more aggressive crunch rhythm sounds in the high gain modes. Be sure to taunt the beast that lurks in CHANNEL 3 MODERN as the **PRESENCE** is truly amazing in this most agro mode.



## CONTROLS: *(Continued)*

**MASTER:** This control is the master feed from the end of the pre-amp to the driver stage and the Effects Loop. As you can see each Channel is fitted with its own **MASTER** control, enabling the four channels relative volumes to be matched regardless of their extremely different sound styles and gain signatures. The **MASTER** control makes possible a wide range of sounds through its ability to use very low **Gain** sounds at high volumes and conversely, high **Gain** sounds at low volumes and everywhere between.



Again, we suggest using the **MASTER** control in its *sensible* ranges ( 9:00 - 2:00 ). Here, the channels will be easier to match with each other and the Effects Loop will see more reasonable signal levels.

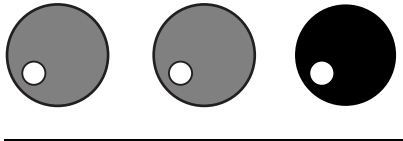

**NOTE:** Because the **MASTER** control creates the send to the Effects Loop, extreme settings will cause a large signal to be sent to the Loop for that Channel. Not only may this cause possible overloading of the processors Input stage, but will make balancing the four channels' Effect Send level difficult.

**OUTPUT CONTROL:** This is the overall **OUTPUT LEVEL** control for the entire amplifier. It is located at the input to the power section and allows you to raise adjust the playing level once you have used the individual CHANNEL MASTER controls to balance the level of the four Channels. The **OUTPUT** receives its signal from the EFFECTS RETURN jacks of both LOOP 1 and LOOP 2 and therefore this control is only in the signal path and active when the EFFECTS LOOP is set to LOOP SYSTEM ACTIVE. When in LOOP BYPASS the individual CHANNEL MASTER controls are the final output level controls.

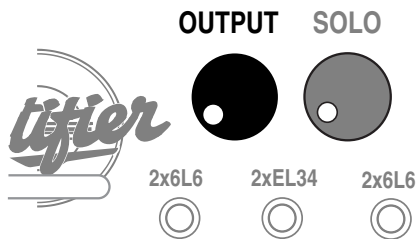

### **NOTE: USING THE ROAD KING AS A POWER AMP ONLY**

It is possible to use the *Road King's* power section as a stand alone power amp for use with external preamps, as half of a stereo power rig or, as a slave for another *Road King* in larger venues. Here's how;

- 1.) Connect your preamp signal to the EFFECTS RETURN jack of LOOP 1.
- 2.) Select LOOP ACTIVE on the Rear Panel
- 3.) Use the OUTPUT control as your power amp level control.
- 4.) Adjust the PRESENCE control of the Channel you are using to taste.
- 5.) Select a Channel and a power setting in that Channel.

All the Progressive Linkage Switching Power Functions will still work if you program power changes to the different CHANNELS and then select channels with the Footcontroller. You do not have to use the switching feature, simply leave the *Road King* in one Channel and select the power section you wish to use in that Channel Strip on the Rear Panel.

Keep in mind that all these different power sections will amplify a given preamp signal differently, so you *will* have volume differences when switching around. This *may* actually fit your needs and can be used to create some interesting power possibilities...especially if the Progressive Linkage Switching was used with a programmable tube preamp such as our *TriAxis* or another parallel with another *Road King*.

We recommend not using the MODERN mode of CHANNELS 3 & 4 for this application as the increased power sensitivity of this mode due to the removal of negative feedback in the power section creates an extremely hard to manage power amp. If you wish to use all four Channels when using the EFFECTS LOOP RETURN as a POWER IN jack we suggest using CHANNELS 1 & 2 in the CLEAN

## CONTROLS: (Continued)

**OUTPUT CONTROL: (Continued)** mode and CHANNEL 3 & 4 in the RAW mode. This will provide uniform input sensitivity and the only volume difference you will experience are those caused by the output power of the different tube harnesses.

**SOLO:** This control is an additional output control wired in parallel with the main OUTPUT that you can pre-set to a higher level and then switch to during performances. A simple idea that adds amazing potential to virtually any sound in the amplifier. Like the

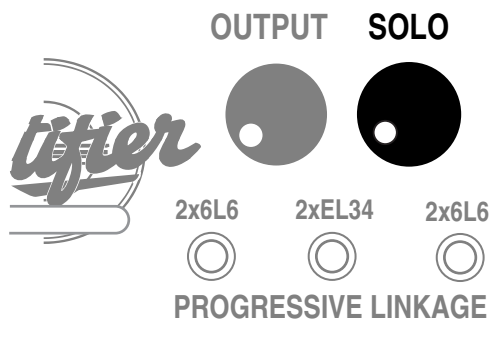

OUTPUT control, **SOLO** gets its signal from the EFFECTS RETURN jacks of LOOP1 and LOOP 2 and therefore it is only in the signal path and active when the EFFECTS LOOP is set to LOOP SYSTEM ACTIVE. This control may be used to step out for a solo or to compensate for other volume drops created by various switching scenarios. One might be a processor in the one of the LOOPS that you love the sound of, but steals gain from your signal when introduced via the LOOP. However you choose to use this valuable feature, **SOLO** adds power and versatility to an already mighty package.

**NOTE:** As mentioned above, when using the *Road King* as a slave power amp the **SOLO** control can be used to provide a footswitchable volume boost for the power amp.

**HI VOLTS:** Perfect for set breaks... this toggle switch also serves an even more important purpose. In the Standby position the tubes are at idle so that during power up they may warm up before being put to use. Before Power is switched on make sure the **STANDBY** switch is in the Standby position. Wait at least 30 seconds and then flip the **STANDBY** switch to the ON position. This prevents tube problems and increases their toneful life substantially.

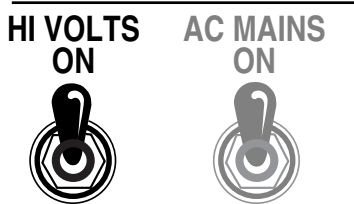

**A.C. MAINS: (POWER ON)** This switch delivers the A.C. power to your new *Road King*. Make sure the unit is grounded (all three terminals of the A.C. power cord must be connected whenever possible to avoid injury to the user as well as to the unit) and that the proper voltage is present. Follow the cold start procedure described in the ON/ STANDBY section above when powering up your new *Road King*.

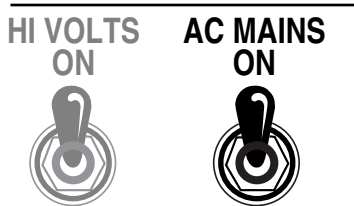

Now that we have reviewed the Channels and their Modes we are ready to go aft and check out the treasure chest of features that ride the Rear Panel.

# REAR PANEL CONTROLS & FEATURES

## REAR VIEW: *Road King*

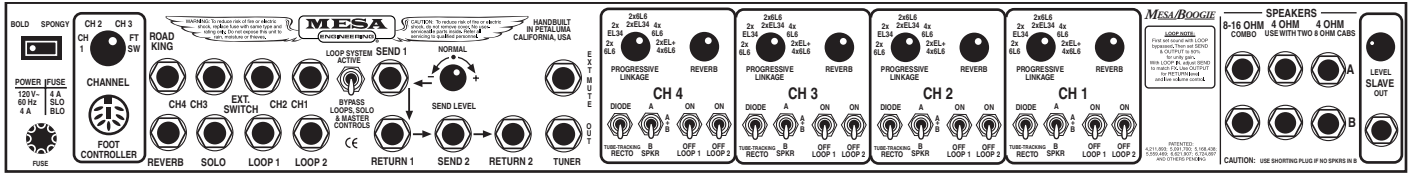

**SLAVE:** This 1/4" jack and control provide a signal derived from the speaker jack. Perfect for using either the *Road King* head version or combo as a master pre-amp and additional power amps for more power when needed. Some players use the **SLAVE** to derive an FX Send Signal and go to other amps for their wet sound.

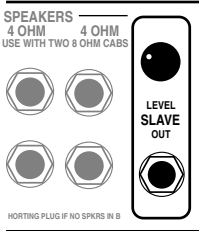

**NOTE:** Once a signal is taken from the **SLAVE**, it can not be inserted back into the FX Loop Return jack or a feedback loop will occur. Much like holding a microphone into a PA system's cabinets...a loud high pitched squeal will be the result.

**SPEAKER OUTPUTS: Bank A & B - Cabinet Switching** These are the speaker output jacks and there are provisions for both 8 and 4 Ohm speaker loads. But as mentioned earlier, this is no ordinary amp...and these are no ordinary speaker outputs. The *Road King* takes the footswitchable independent Channel concept a step further by providing two pre-assignable speaker outputs, enabling you to use two different types of speaker cabinets with the same power section. They can even be of different impedance's! For example you might want to use an open back cabinet with one type of speakers for your clean CHANNELS 1 & 2, and switch to closed back cabinetry with a different type of speakers for you lead work in CHANNELS 3 & 4. You can take this a step further and use both sets of jacks and combine them for a specific channel so that both open and closed back cabinets are on at once for a truly huge sound. These choices can be assigned per channel in the individual Channel Strips under **SPKR A/B**. Use any cabinetry you like as the *Road King* is not particularly sensitive to speaker impedance mismatches, other than decreasing headroom slightly or making your power tubes work a little harder.

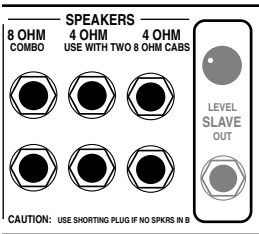

However, **It Is Extremely Important To Keep A Load On The Output Transformer At All Times!** Failure To Do So Will Damage The Output Transformer And Void Your Warranty. For this reason we have included a Shorting Dummy Plug that we have attached permanently to the chassis to prevent accidental "no load" scenarios. We ship this shorting jack connected the "B" SPEAKER OUTPUT so that if a channel is selected that is assigned to either the "B" or "A & B" OUTPUT choices, there will still be a load on the Output Transformer.

**NOTE:** Please make sure that the attached Shorting Jack is connected to the "B" SPEAKER OUTPUT jack at all times when not using the Cabinet Switching Feature.

**NOTE:** You will experience a brief second when both speaker cabinets will be active during a cabinet switching sequence. This is normal and necessary to protect the output transformer from damage due a possible "no load" scenario during the instant of switching.

**NOTE:** If you switch to a Channel when not using the Cabinet Switching Feature and experience low output combined with a broken up, distorted signal, or no output at all, check that Channels' SPEAKER ASSIGN mini toggle to be sure that it is not set to **SPKR "A + B"** or "B".

**NOTE:** Do not use the SPKR A + B selection when two 8 Ohm cabinets are each connected to the two 4 Ohm OUTPUTS of each Speaker Output Bank. A 2 Ohm load puts an excessive strain on the power tubes causing them to wear unusually fast.



# REAR PANEL CONTROLS & FEATURES *(Continued)*

**REVERB:** These 4 rotary controls determine the dry/wet mix ratio for the rich analog **REVERB** and are wired to the Reverb return circuit. Each of the 4 Channels have a dedicated control so that a different Reverb mix can be attained for each individual sound.

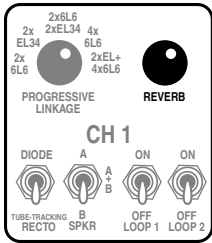

The controls sweep from a subtle background effect at their low range to a drenched, swimming effect at the top of the control. Several factors affect the **REVERB** tone and drive including the different Modes' gain structures, preamp gain settings and CHANNEL MASTER and OUTPUT control settings. Generally speaking, lower gain settings will produce cleaner, purer Reverb effects, while higher gain settings will produce more smeared, washy Reverb sounds. This difference can be useful, desirable and is a normal characteristic of Reverb circuits of this type.

The **REVERB** may be switched in and out of the circuit via the **REVERB** button on the Footcontroller.

**NOTE:** It is normal to experience approximately 1-2 seconds of delay before the **REVERB** is mixed with the dry signal after switching the **REVERB** or Channels. This intentional built-in delay prevents both switching noise from the hard bypass relays used to isolate the pure dry signal from the effected **REVERB** signal, and the prior Channels sound coming through the **REVERB** in the current Channel when switching. At first this may seem strange, but after a couple minutes in real world situations you will see that it is preferable to the embarrassing alternative of a loud overdriven crunch chord drowning out your beautiful clean passage in the middle of a breakdown.

**CHANNEL STRIPS:** These 4 clusters of switches and controls house the specific features that can be pre-assigned per individual channel. Once you have deciphered one, you have learned the *Kings'* secret and are ready to rule, for they are simply repeated for the 4 channels.

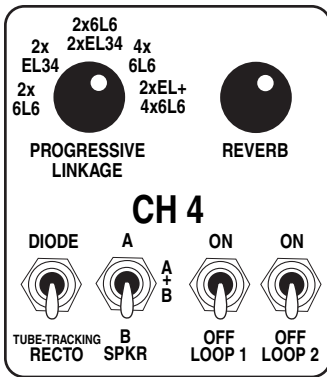

This section is where you choose the status of LOOP 1 & 2, your choice of Speaker enclosure(s), what type of Rectifier you wish to use and most importantly the power section you wish to combine with your preamp choice with the PROGRESSIVE LINKAGE rotary control. Let's go over the controls one at a time, beginning with this most important choice.

**PROGRESSIVE LINKAGE:** This 5 position rotary control contains the most powerful feature ever found on a self contained amplifier, the ability to assign your choice of 5 different power amplifiers to one of the 4 preamps and footswitch to it. Although this is not our first amplifier to showcase this patented feature – the single channel *BLUE ANGEL* first introduced it – the power of **PROGRESSIVE LINKAGE** reaches maturity here in a multi-channel format that should make all serious guitarists

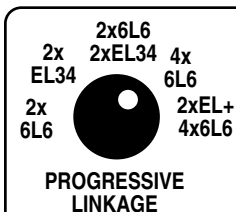

reconsider the very nature of channel switching amplifiers from here forward. By exploring the possibilities of this awesome feature and understanding how to combine the front end preamp choices with a power section that enhances that sound, you will be able to use the *Road King* to its full potential. The choices are laid out in a logical left to right array with the lowest wattage settings to the left and the most powerful RMS ratings to the right. On the Front Panel you will find the valuable **PROGRESSIVE LINKAGE** LED status indicators, which keep you informed of your current power status at all times...even from across the stage. Here is a *one-dimensional* description of the choices and their individual characters.

# REAR PANEL CONTROLS & FEATURES *(Continued)*

## SELECTING POWER TUBES:

**2x6L6** produces roughly 50 watts of bubbly resilient magic and is one of our favorite setups in the entire amplifier. It is wonderful for both low and high gain styles and has probably the best balance frequency-wise for both types of sounds. The low end is bouncy and rich, while the top end smiles with sweetness and seems to exorcise all the harsh frequencies and showcase the pleasing ones. The inherently vintage voice of this power duo lends itself to blackface era clean sounds especially well and some of the best clean sounds in the entire amp can be found here.

Be sure to experiment with the TWEED mode of CHANNEL 1 in combination with the **2 x 6L6** for there are hours of good clean fun awaiting you here. Another attribute of this setting is the way it responds to both RAW and VINTAGE in CHANNEL 3. Because of its balance and harmonically friendly nature, the gain sounds seem to turn into the creamiest tone soup we've ever experienced. The overall character is elastic, making the strings feel easier to play and more expressive and yet they respond to every nuance of your playing style.

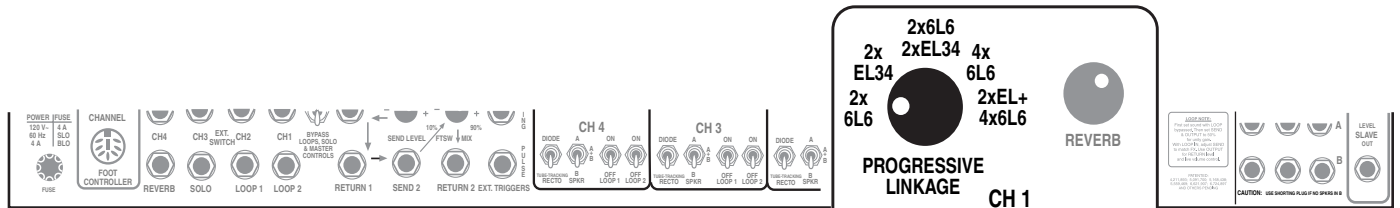

**COMBO VERSION 2 x 6L6  
(partial rear chassis view)**

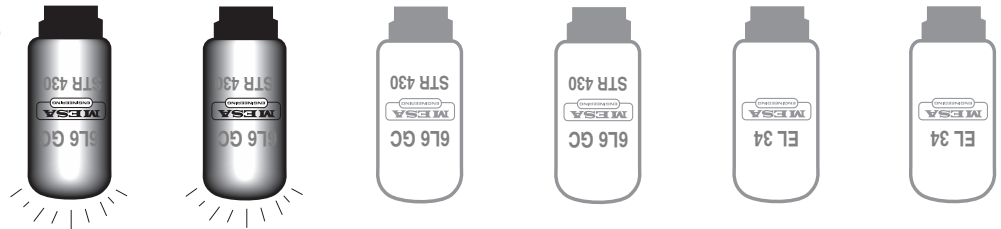

**HEAD VERSION 2 x 6L6  
(partial rear chassis view)**

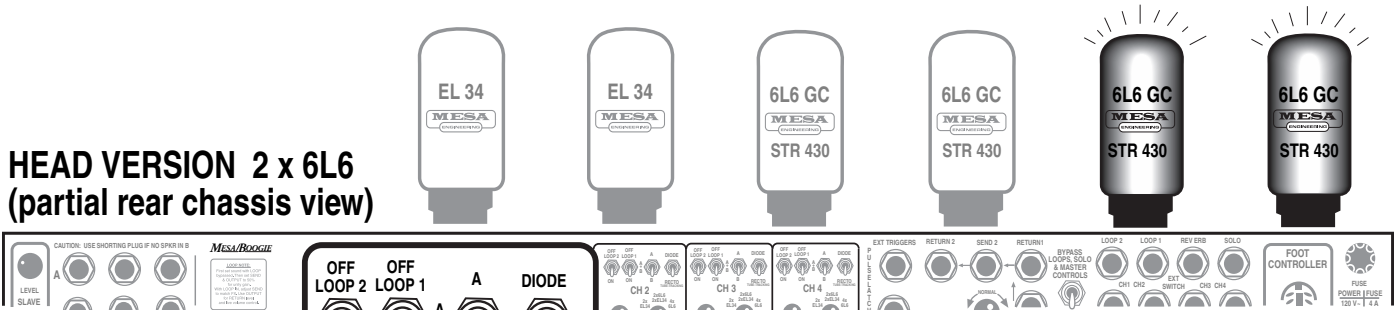

# REAR PANEL CONTROLS & FEATURES *(Continued)*

## SELECTING POWER TUBES: *(Continued)*

**2xEL34** is similar in output to the 2 x 6L6 duo but oddly enough can at times seem more powerful to the ear and has a very different character. The emphasis here is on top end and a more urgent stripped attitude. While this setup works for both low and high gain sounds, the additional top end accentuation combined with a drier low end makes clean sounds a bit more challenging to dial. There are some great *edge of clean* sounds possible, especially in the BRIT mode of CHANNEL 2 where the lower mid characteristic is complimentary to these brighter tubes.

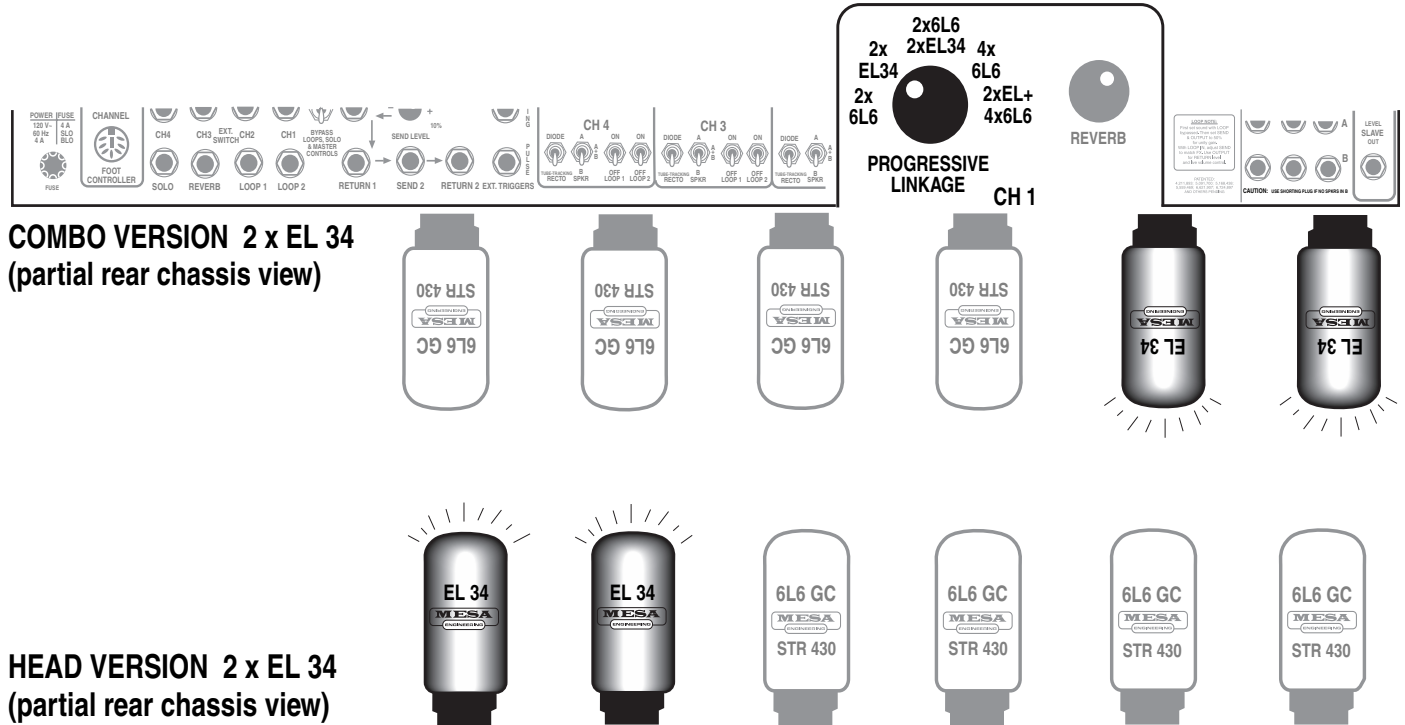

The **ELs** have the harmonic spread, but not quite the balance of the 6L6 and this makes these Euro-born pentodes hygienically challenged when compared to the 6L6. For gain sounds though, they have an attitude all their own that is undeniable in its brash urgent glory. The seeming lack of sub-low performance hinders them a bit for modern high gain mosh or metal sounds, but they own the territory between clean and crunch with a lushness of harmonics and top-end shred that is wicked, yet musical. Only these tubes respond with a looseness that is a benefit, for it produces that coming-apart-at-the-seams vibe that can put danger in any Rock and Roll part played through this rebellious team. Check out RAW and the lower half of VINTAGE in CHANNELS 3 and 4 for a world of these sounds, but ride the PRESENCE with care as there is substantially more high end here than any other power choice.

## REAR PANEL CONTROLS & FEATURES *(Continued)*

### **2xEL34:** *(Continued)*

**NOTE:** *It has been our experience that different types of EL34 seem to have drastically different sonic characters. The classic skinny German Siemens type sound much as they look, skinny and bright with a looser nature, and are by far the best sounding EL34 to our ears. These tubes are out of production and are available only as coveted New Old Stock and most EL34 aficionados search far and wide for these harmonically luscious pentodes. For **Road King** owners we have a limited supply of these New Old Stock tubes and you can contact our Customer Service Dept. and they can sell you a set. However, these are unfortunately, less reliable and if you prefer these, we suggest that you keep a spare set and some fuses on hand should they go bad. We suggest using these tubes for recording only in a stable environment, as they do not seem sturdy enough for the rigors of the road.*

*Because the Siemens tubes are no longer available in quantity, we have shipped your amplifier with the best sounding EL34 currently available. This EL34 is made in Russia and has very similar characteristics to that of the Siemens and actually has slightly more output. Best of all is that these tubes are much more reliable and are available and still being made. We suggest using these for your live and all around applications. The fatter U.S. type (also known as 6CA7) produce a sound that has some of the characteristics of the 6L6 and they too sound like they look, fatter and beefier, which is not as readily identifiable as a true EL34 sound. As you might guess, we have found these to be more reliable also and it comes down to which is more important to your individual needs. Regardless of your choice it is always a good idea to carry a full set of extra tubes and fuses in your cord bag at all times whenever using gear that relies on this quirky, yet most toneful technology.*

# REAR PANEL CONTROLS & FEATURES *(Continued)*

**2x6L6 & 2xEL34:** revisits a harness we used back in the mid '80's when we shipped our patented *Simul-Class Mark II-C* amplifiers with a pair of each of these classic tube types. The combination produced a legendary power sound that was used by the heaviest of L.A.'s session players of the day. Steve Lukather, Mike Landau and Dan Huff (as well as players around the world) became instant fans of this unique sound and blessed many a great track with their phenomenal playing through this blistering power combo. It made perfect sense to us to combine these two sonically opposite pentodes and the wiring of our *Simul* power section made this previously overlooked magic possible.

In the *Road King* this combination is achieved by different means but produces no less amazing results. This power section also works well with both clean and overdriven sounds as the combination produces the balance that the **EL34's** sometimes lack for clean sounds.

For lead or crunch rhythm sounds it is an explosive blend as the **6L6** provide the midrange punch and low end fatness and definition, while the **EL's** infuse the top end with their shredding aggressive urgency. This marriage of tubes produces one of the most aggressive power sounds of any amplifier ever. Be sure to check it out in combination with the CHANNEL 3 and 4 MODERN mode for a lesson in bad attitude.

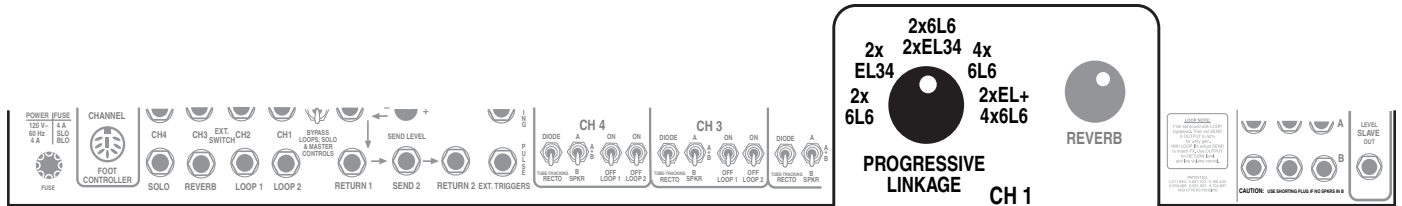

**COMBO VERSION**  
2 x 6L6 and 2 x EL 34  
(partial rear chassis view)

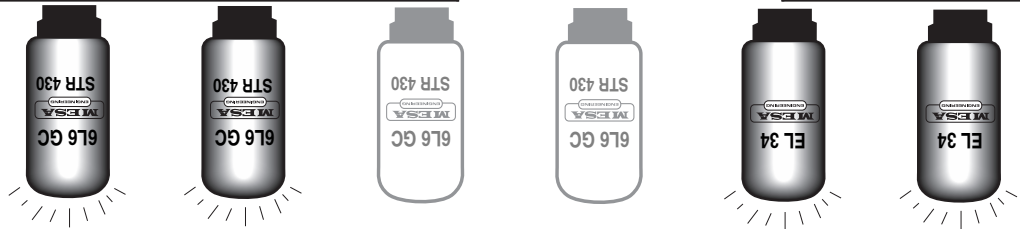

**HEAD VERSION**  
2 x EL 34 and 2 x 6L6  
(partial rear chassis view)

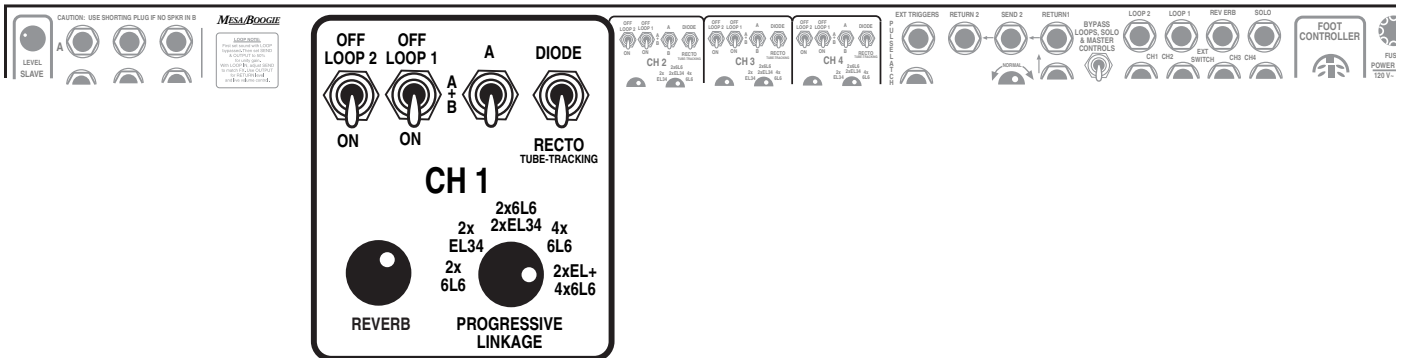
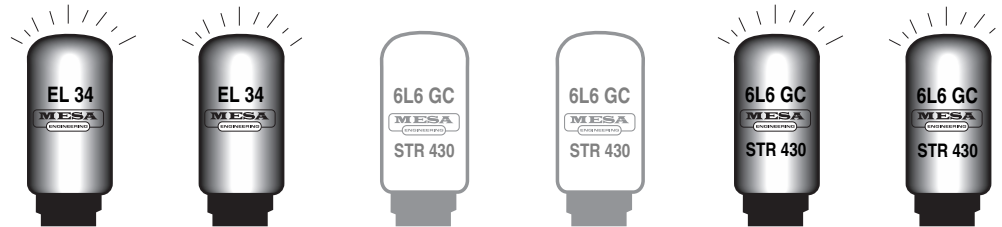

# REAR PANEL CONTROLS & FEATURES *(Continued)*

**4x6L6:** is the tried and true power section for high power and great tone. This classic string provides the best overall balance for all 4 of the *Road King* preamps with no tonal downsides. There are no liabilities with this super tight, well rounded quartet as they produce smooth response over the entire frequency range and provide a cohesiveness to even the most extreme overdrive sounds. They also provide the sweetest high power clean sounds because, even though all six power tubes run together produces more power, they create some peaks that are great for super high volume playing but lack the pristine blend of the **4 x 6L6** harness. This is also the power section that has been so successful in the *Dual Rectifier SOLO Head!*

If you are looking for the amazing liquid gain sounds from the *Recto's* VINTAGE mode or the infamous grind of the *Rectos'* MODERN mode, this power setting will duplicate those radical sounds in all their glory. Remember to match up the Rectifier...to cop the *Rectos'* most popular settings set to TUBE TRACKING for VINTAGE and DIODE for MODERN.

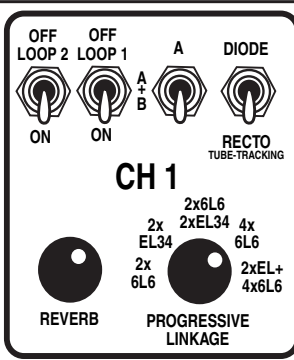
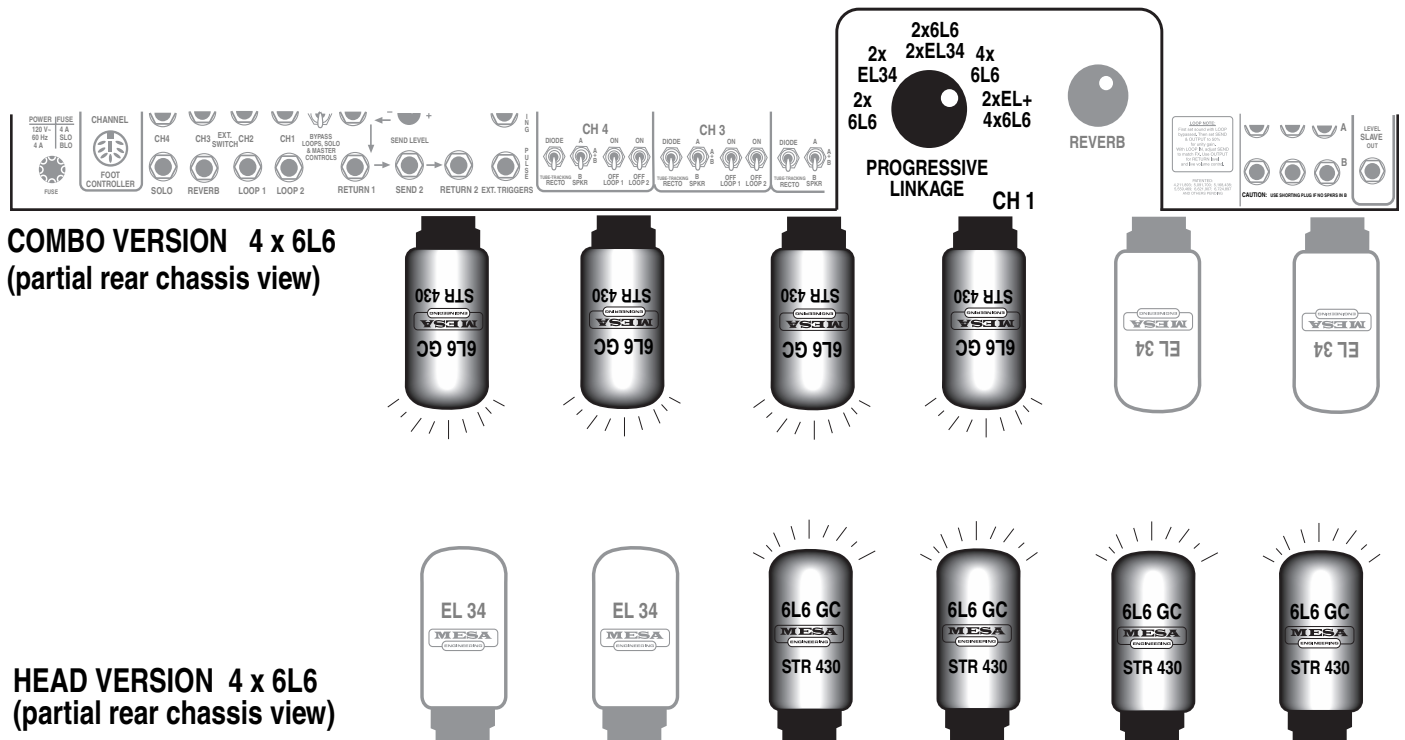

# REAR PANEL CONTROLS & FEATURES *(Continued)*

**2xEL34 + 4x6L6:** is the heavy artillery for large venues, extreme headroom or for any time you need to add unequaled power to any of your sounds. This setting wires up all six power tubes to produce roughly 135 watts of crushing power and therefore, you may find it hard to utilize in smaller rooms. In some cases the feel on the strings may be a bit stiff, or at least tighter at these lower relative volumes because the power section is running at idle up until volume levels loud enough to need substantial room to breath.

However, when it comes time to play outdoor gigs or big stage venues, there is no mistaking the authority, punch and definition of this mighty power section. A bolder version of the 2 + 2 combination, this scheme relies more on the 6L6's and therefore is a little richer in character with slightly less emphasis on the top end than the harness with equal pentode representation. This makes for a sound that has more midrange punch and low mid fatness and will work equally well for either clean rhythm or high gain lead sounds.

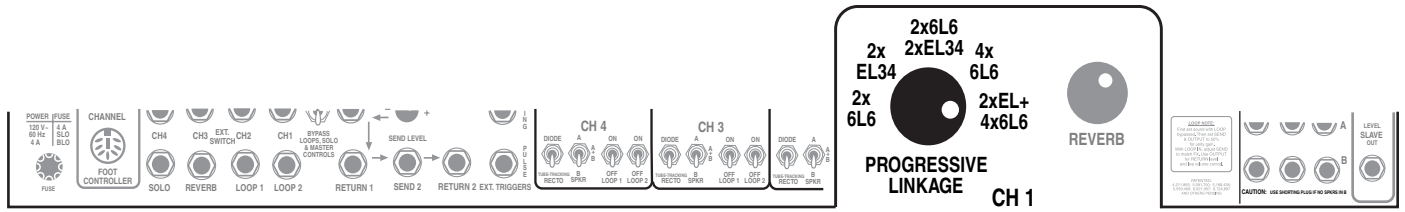

**COMBO VERSION**  
2 x EL 34 and 4 x 6L6  
(partial rear chassis view)



**HEAD VERSION**  
2 x EL 34 and 4 x 6L6  
(partial rear chassis view)

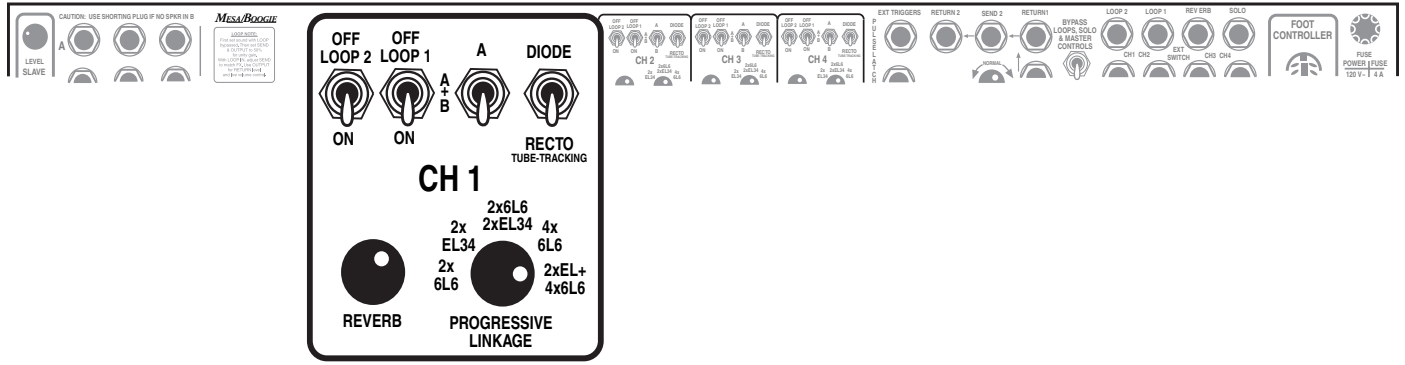



# REAR PANEL CONTROLS & FEATURES *(Continued)*

## **RECTIFIER SELECT with TUBE-TRACKING:**

This amazing feature takes our patented Dual Switchable Rectifier concept a step further and allows the tube rectifier circuit to track the PROGRESSIVE LINKAGE switchable power and provide the correct amount of rectification for each power section. The original choices of TUBE or SILICON DIODE are still in place but here, when **RECTO TUBE-TRACKING** is selected in each Channel Strip, rectifier tubes are selected depending on the needs of each of the 5 power sections.

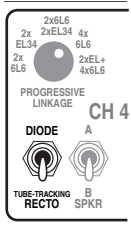

This means that you can tune each of the Channels' power feel to the preamp sound you are dialing. You might want CHANNEL 1 running the DIODE with 4 x 6L6 for high headroom clean work while CHANNEL 2 runs **TUBE-TRACKING** with 2 x EL34 for a loose edgy roots rhythm sound. For the Lead Channels, you might want CHANNEL 3 VINTAGE pumping **TUBE-TRACKING** through the 2 x 6L6 + 2 x EL34 for smoldering single note solos and DIODE pushing 4 x 6L6 for the tightest of CHANNEL 4 MODERN grinding crunch rhythm sounds. Countless choices are possible with the many different combinations and they all have their place for specific sounds. There are Front Panel LED indicators labeled RECTIFIER STATUS that keep you currently informed of your Channel Specific choices of Rectifier style. Here is an explanation of how the two choices work;

## **DIODE:**

calls up the silicon diode rectifier, which offers more punch, a tighter attack with more brightness and substantially more headroom. This rectifier choice provides the highest power and therefore the tightest rectification. This setting would be best for any application where maximum headroom is needed or tight bass response is called for. Situations that usually require this are clean rhythm playing or extreme high gain crunch rhythm sounds.

## **RECTO TUBE-TRACKING:**

takes a power section walk down memory lane, paying tribute to those vintage gems of yesteryear. In those early days of amplification the only rectifiers available *were* tubes. Unbeknownst to their creators, these sweet sounding amplifiers would someday become relics as the demand for higher volumes and more power per package led to the abandonment of the tube as a rectifier, in favor of the five cent silicon diodes' greater efficiency. With this decision went much of the sweetness and soul and by the late '60's most amps were bold, loud and efficient...but unfortunately sometimes lacking that earlier soul. We sought to bring that magic soul, personality and feel to the *Dual Rectifier* Series, and the resurrection of this age-old circuit does just that.

In the *Road King* it was a little more of a challenge however, because each of the 5 power sections would require a different amount of rectification to put out its full power potential. And beyond that, each channel would have to be able to have these two interrelated circuits pre-assigned specifically and independently! This led to the concept of **RECTIFIER TUBE-TRACKING**. In this innovative circuit a rectifier tube, or pair of rectifier tubes, is selected to correctly match the power tube choices you select. Here is a list of the matched sets;

### Rectifier / Power Tube Combinations In TUBE-TRACKING

- 2 x 6L6 ~ 1 x 5U4G
- 2 x EL34 ~ 1 x 5U4G
- 2 x 6L6 + 2 x EL34 ~ 2 x 5U4G
- 4 x 6L6 ~ 2 x 5U4G
- 2 x EL34 + 4 x 6L6 ~ Silicon Diode

You will notice that when all six power tubes are in use, the rectification type matched to this high horsepower string is the silicon diodes. Tube rectification is not available or possible for this power harness and there are two reasons for this. First, the choice would rarely be used if it were available because the whole point of this extreme power section is very high volume applications such as in large venues or extreme heavy styles of music. In these two arenas the slower, looser tube rectifier would be out of its league and begin sagging-out before the power tubes reached their potential full output. We have confirmation of this by polling our *Triple Rectifier* Artists and players that use this mighty amp to its full volume potential in large venues and they uniformly use the Silicon Diodes even when they *do* have the choice of **TUBE RECTIFIER**. Second, the *Road King* is supremely packed with circuitry making the channel specific programmable features possible, including six power tubes, that there was literally no room to include one more 5U4G which would be needed to properly rectify this harness. After spending time with these choices you will find – like we did - that you use the highest power all-six-at-once section for exactly what it was designed for, and is best at...loud, crushing volumes and super tight attack. Two applications that are at the sonically opposing end of the spectrum from the characteristics of tube rectification.



# REAR PANEL CONTROLS & FEATURES *(Continued)*

## **SPEAKER A / B & A + B SELECT SWITCH:**

As mentioned earlier in the SPEAKER OUTPUT section, this mini toggle assigns the signal to either one or both of the Speaker Output jacks. The default setting would be considered “A” and therefore the dummy shorting jack that protects the output transformer is connected to the “B” Output and should remain so until you connect a speaker load to this output.

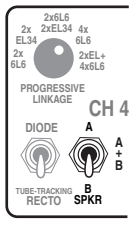

**PLEASE READ THE SPEAKER OUTPUT SECTION AS IT CONTAINS INFORMATION PERTAINING TO YOUR WARRANTY, as well as information to help you utilize this feature to its full potential without damaging your amplifier.**

**NOTE:** Do not use the SPKR A + B selection when two 8 Ohm cabinets are each connected to the two 4 Ohm OUTPUTS of each Speaker Output Bank. Using a 2 Ohm load puts an excessive strain on the power tubes and will cause them to wear out unusually fast.

## **LOOP 1 & LOOP 2 SELECT SWITCHES:**

These two mini toggle switches in each of the Channels assign the two Series EFFECTS LOOPS and determine their status in the signal path. Once the LOOPS have been engaged, their Channel specific status is sent to the Front Panel FX LOOPS LED indicators that sit between the pairs of Channels for at-a-glance monitoring of their status. See the EFFECTS LOOPS section for more information on the LOOPS.

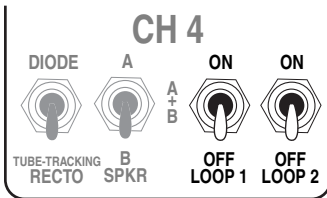

**NOTE:** Remember that the EFFECTS LOOP must be engaged in the EFFECTS LOOP section of the Rear Panel for signal to be routed via these switches.

## **TUNER:**

This output provides a Rear Panel interface for connection of a tuner. This way, the important, toneful relationship between your instrument’s pickups and the Road King’s all tube Input stage remains direct and uncompromised. The output level of the TUNER OUT jack is optimized for this application.

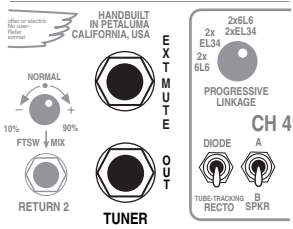

The King Controller footswitch provides a “silent tuning” feature via a switch labeled TUNER MUTE. When this switch is triggered, all sound through the speakers is muted so you can tune the instrument without annoying bandmates, engineers or an audience.

**EXT MUTE:** This jack controls the Tuner Mute function when the Road King Footcontroller is not going to be used as the main access to the King’s sounds and features in favor of an external master switching system. In this scenario, all Channels, Reverb, SOLO and LOOPS would be patched in to

the master switcher using the eight ¼” jacks on the Rear Panel labeled EXT SWITCHES (adjacent to the King Controller Input DIN jack and Channel Select Rotary). All sounds and features would then be triggered (usually under programs) from the master switcher. The Tuner Mute Function must be connected in the same way, but in its location separate from the other EXT SWITCH jacks (between the Channel Strips and the Loop). All External Switch jacks including the EXT MUTE jack respond to grounding type (tip to ground) logic to control their functions.

# REAR PANEL CONTROLS & FEATURES *(Continued)*

**EFFECT LOOPS:** As we mentioned earlier, there are two SERIES LOOPS for your processing needs. The entire LOOP section of the amplifier may be Hard Bypassed to omit all associated loop circuitry from the signal path. When BYPASS is selected, both LOOPS along with their controls, the Front Panel OUTPUT and SOLO controls and two 12AX7's are taken out of the circuit. This leaves the

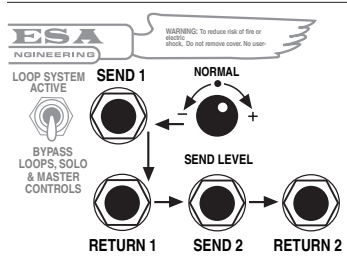

individual Channel MASTER controls as the main volume controls. Front Panel LED indicators for each Loop located between the pairs of Channels to keep you abreast of LOOP 1 & 2 status. Just to the right of the ACTIVE/BYPASS switch are the patch points for inserting your processing. Because the KING features two effects loops, there are two sets of SEND and RETURN jacks and a master SEND LEVEL control for adjusting the amount of overall post Channel Master signal fed to your processing. The two LOOPS may be footswitched in and out of the signal path only when the Loop Status switch is set to LOOP SYSTEM ACTIVE (up). To use either or both of the EFFECTS LOOPS, follow these steps:

## PATCHING EFFECTS:

Try this method of interfacing outboard processors for the best results;

### LOOP 1 & 2:

- 1.) Connect the SEND jack to the processor's INPUT.
- 2.) Connect the RETURN jack to the processor's OUTPUT.
- 3.) Dedicate and Dial in your sounds in each of the four preamp Channels and adjust Channel MASTER settings for volume balance (this affects send level strength in the LOOPS).
- 4.) Engage the two LOOPS by selecting LOOP SYSTEM ACTIVE on the Rear Panel Loop Status Switch.
- 5.) Adjust SEND level signal with the SEND LEVEL control to achieve a good INPUT level at your processor - "unity gain" is best. (Check this by switching the Loop Status switch to BYPASS(down) and there should be very little, if any, difference in volume).
- 6.) Select LOOP SYSTEM ACTIVE on the Loop Status switch again and enjoy a switchably wet Road King.

**NOTE:** Keep in mind that cleaner sounds, although they appear to be the same volume as saturated sounds, send a more dynamic signal to your processor and therefore will probably register a hotter signal on the processors' Input indicator. This is not a problem, but it will be of interest when setting up your sounds in the channels. Set the Channels for their relative volume and don't pay too much attention to the processors Input unless you experience clipping. If so, reduce all the Channel MASTER controls a bit and compensate with the OUTPUT control.

**NOTE:** It is important to understand that the two EFFECTS LOOPS were designed to work best with a unity gain signal. By increasing the gain on your processors Input or Output beyond this point, you run the risk of experiencing a high pitched squeal or feedback. This is a result of the SEND and RETURN jack being connected together by adding excessive gain at the processors Input and Output stage, thus reducing the internal separation between these stages we have built into the *Road King's* EFFECTS LOOP. Why can't there be more separation at this point in the circuit? There could be if we -and you - didn't care about TONE. This is an extremely sensitive part of any amplifier, and we have always chosen these most critical part values on the side of TONE, knowing that if the loops are used properly - with high quality processors there will be no problems.

Please try to keep in mind that this is a high performance amplifier and should be used in conjunction with outboard gear of equal quality. If you must use lesser processing, you will have to tolerate any degradation in sound quality and remember that turning up the gain of such a processor much at all will only cause feedback problems.

# REAR PANEL CONTROLS & FEATURES *(Continued)*

## **PATCHING EFFECTS:** *(Continued)*

**NOTE:** Remember that the LOOP BYPASS switch removes all LOOP circuitry from the signal path including, 2 x 12AX7's, LOOPS 1 & 2, and the OUTPUT and SOLO controls.

**NOTE:** When using the *Road King's* EFFECTS RETURN jack as a Power Amp Input, the input sensitivity will be most "normal" in CHANNELS 1 and 2. For increased power sensitivity you may choose the incredibly sensitive CHANNEL 3 or 4 MODERN mode.

This will increase the power section input sensitivity by an order of ten. Be warned, this will make the OUTPUT level control extremely sensitive and the amplifier will be LOUD!

**NOTE:** See the section on OUTPUT in the CONTROLS section earlier in this manual for more information on using the *Road King* as power amp only.

## **EXTERNAL SWITCHING:**

These eight jacks are provided so that you may control the 4 Channels, the 2 LOOPS, The Reverb and the SOLO feature with an external master Switching device. This is essential to use the *Road King* as part of a Midi rig where all sounds are called up via a Midi Footcontroller and both amplifier and effects settings are stored under a midi program number. The logic used to trigger these ports is simple tip-to-ground, latching type and most Master switching systems incorporate several jacks dedicated to this logic.

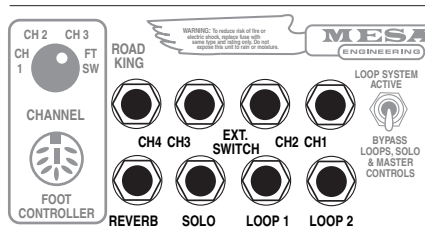

The **EXTERNAL SWITCHING** jacks override the *Road Kings'* Footcontroller. Once a Channel or Feature has been triggered "On" at the EXT. Switch ports, it may not be controlled or turned "Off" until the logic at the Switch Port is reversed.

## **POWER: SPONGY / BOLD:**

Two different A.C. power voltages may be Selected in your *Road King* by using the built-in Variac feature of the **SPONGY / BOLD** switch.

## **SPONGY:**

Works as a Variac to reduce all internal voltages, giving the whole amplifier a sweeter, looser feel and when used with the RECTIFIER TUBE-TRACKING can achieve the elusive "Brown" sound. Clean sounds will be scoopier in the midrange and the top end harmonics will move forward a bit in the mix. Overdrive sounds will seem more legato and spread out, feeling looser and slightly brighter. Be sure to check out **SPONGY** in combination with the 2 x EL34 power section set to RECTO TUBE-TRACKING for the ultimate brown clip. Another cool (literally) benefit to using the **SPONGY** position is that tube life will be substantially increased as the voltage is lowered to the point that the tubes are way below their ratings and will last longer with improved reliability.

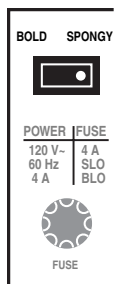

Don't run your *Road King* in **SPONGY** for this reason alone...we have paid great attention to reliability and if you prefer the sound in BOLD (we do for most sounds) by all means...roast the buggers. With our many years of amplifier building, and our contact with thousands of happy customers worldwide, tube life and reliability seem as much luck as anything else. Most customers never have to give their tubes a thought until they sound dull and need replacing as part of a routine maintenance schedule.

## **BOLD:**

Runs all internal voltages at their normal operating range and would be considered the all around, best sounding selection. This setting provides the highest headroom for the two Clean Channels and keeps the focus intact and the bass frequencies tight in the two high gain Channels. Use this setting for most live applications as it is the most versatile and powerful scenario.

# REAR PANEL CONTROLS & FEATURES *(Continued)*

## **FUSE:**

This is the A.C.'s (Alternating Current) main fuse and provides protection from outside A.C. fluctuations as well as power tube failure damage. Should the **FUSE** blow, replace it with the same rating in a Slo-Blo type package. The domestic U.S. version requires a 4 amp Slo-Blo fuse. A power tube short or failure is often the cause of a blown fuse...Follow the cold start procedure mentioned in the Hi Volts switch section and watch the power tubes as you flip the Hi Volts to the ON position. If a power tube is going bad or is arcing you will see it! Flip the Hi Volts switch down immediately and replace the faulty power tube and the **FUSE** if necessary.

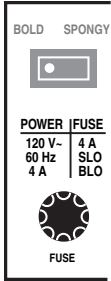

If you see nothing abnormal as you lift the Hi Volts switch, it is possible that a power tube shorted temporarily and blew the **FUSE**. If this is the case it may work again normally. To be safe, you might want to replace just the adjacent tube or all power tubes in the “shotgun” troubleshooting tradition and save the replaced set as spares. Spare fuses are a must for the fabled cord bag along with your spare tubes. Always carry both for they could be worth their weight in gold someday.

## **SERIAL NUMBER:**

The Serial Number of your amplifier is printed on a small metal tag attached to the tube side of the chassis near the Reverb and Solo External Switching Jacks (see pg 23 for reference). You'll need this number when registering your amplifier for warranty.

That covers the features and functions on the Rear Panel and by now you should be ready to start crafting your dream Tone. If you would like some examples of ways to set the modes in your *Road King* for different applications, you may find the following SAMPLE SETTINGS helpful.

We wish you a lifetime of amazing and inspirational Tone from your new musical instrument and our hope is that it takes you to new and exciting places on your musical journey.

# FACTORY SAMPLE SETTINGS:

## CHANNEL 1 SETTING #1 Versa Clean

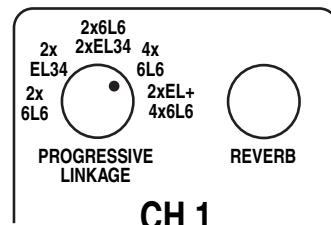
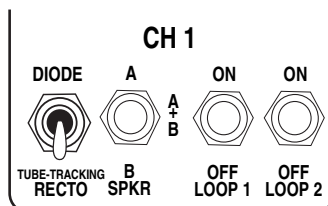
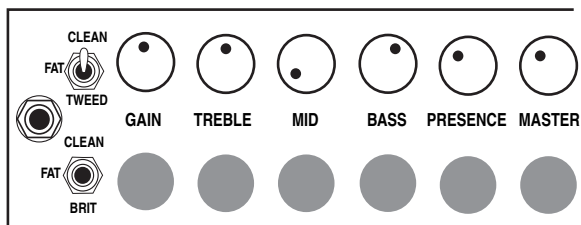

## CHANNEL 1 SETTING #2 Spank

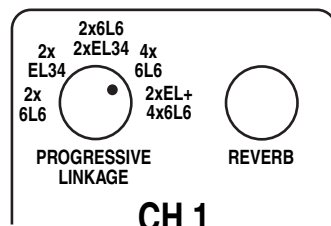
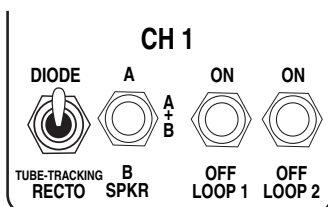
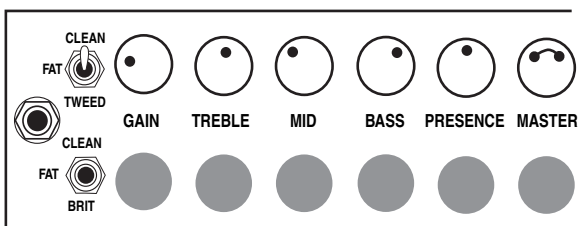

## CHANNEL 1 SETTING #3 Elastic Tweed

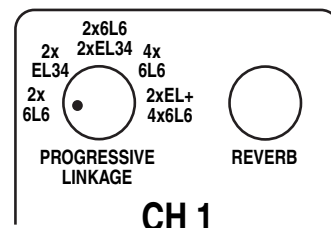
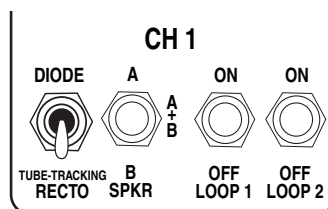
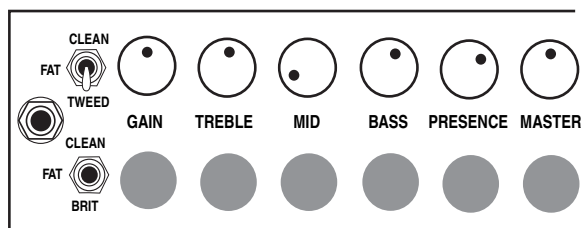

## CHANNEL 1 SETTING #4 Fat Solo

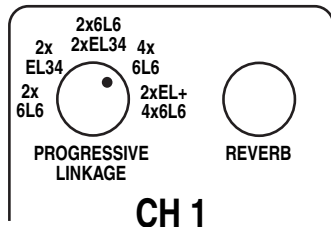
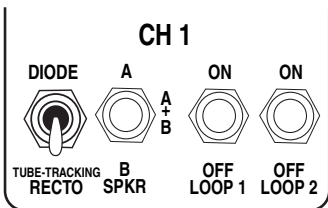
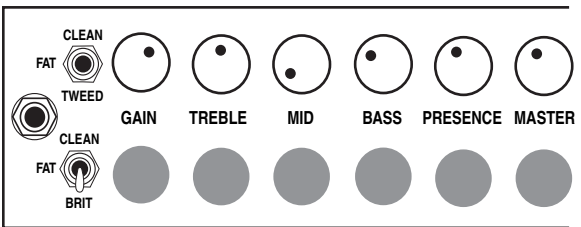

# FACTORY SAMPLE SETTINGS:

## CHANNEL 2 SETTING #1 Skinny Skank

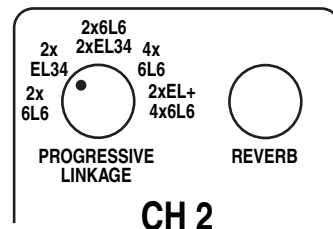
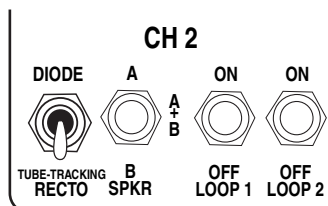
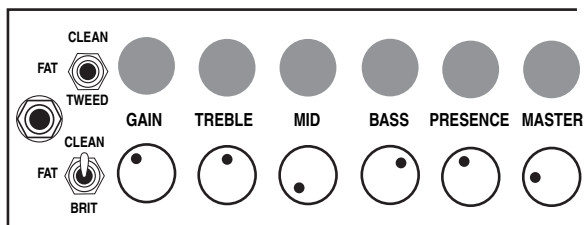

## CHANNEL 2 SETTING #2 Rhythm Mix

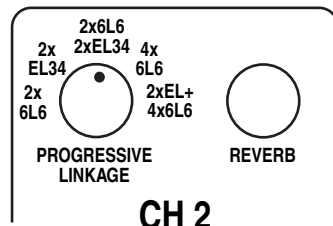
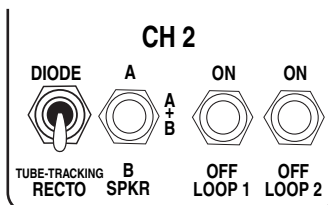
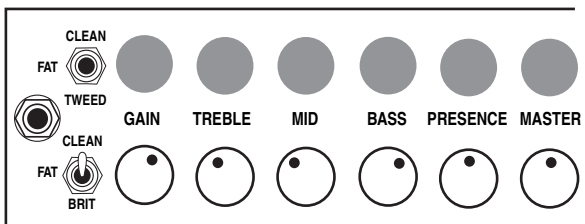

## CHANNEL 2 SETTING #3 Power Rhythm

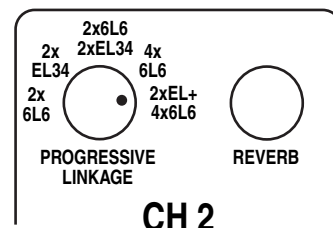
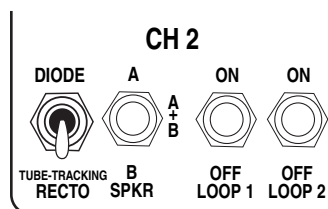
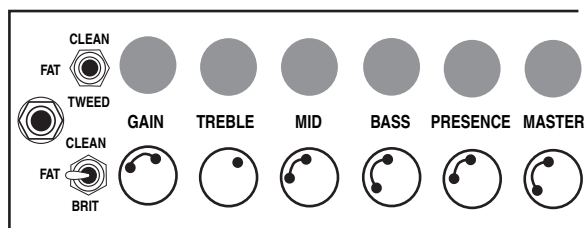

## CHANNEL 2 SETTING #4 Brit Grind

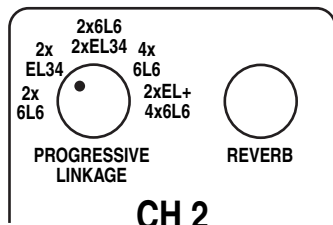
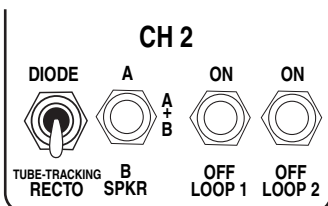
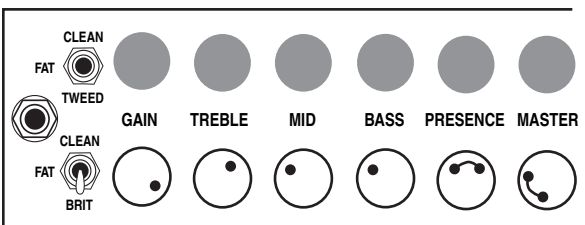

# FACTORY SAMPLE SETTINGS:

## CHANNEL 3 SETTING #1 Purring Blues

RAW VINTAGE  
MODERN

GAIN TREBLE MID BASS PRESENCE MASTER

RAW VINTAGE  
MODERN

### CH 3

DIODE A A+B ON ON  
TUBE-TRACKING B OFF OFF  
RECTO SPKR LOOP 1 LOOP 2

2x6L6  
2x EL34 4x 6L6  
2x 6L6 2xEL+ 4x6L6

PROGRESSIVE LINKAGE REVERB

### CH 3

## CHANNEL 3 SETTING #2 Smooth Grind

RAW VINTAGE  
MODERN

GAIN TREBLE MID BASS PRESENCE MASTER

RAW VINTAGE  
MODERN

### CH 3

DIODE A A+B ON ON  
TUBE-TRACKING B OFF OFF  
RECTO SPKR LOOP 1 LOOP 2

2x6L6  
2x EL34 4x 6L6  
2x 6L6 2xEL+ 4x6L6

PROGRESSIVE LINKAGE REVERB

### CH 3

## CHANNEL 3 SETTING #3 Liquid Solo (Recto Vintage)

RAW VINTAGE  
MODERN

GAIN TREBLE MID BASS PRESENCE MASTER

RAW VINTAGE  
MODERN

### CH 3

DIODE A A+B ON ON  
TUBE-TRACKING B OFF OFF  
RECTO SPKR LOOP 1 LOOP 2

2x6L6  
2x EL34 4x 6L6  
2x 6L6 2xEL+ 4x6L6

PROGRESSIVE LINKAGE REVERB

### CH 3

## CHANNEL 3 SETTING #4 Giant Fur

RAW VINTAGE  
MODERN

GAIN TREBLE MID BASS PRESENCE MASTER

RAW VINTAGE  
MODERN

### CH 3

DIODE A A+B ON ON  
TUBE-TRACKING B OFF OFF  
RECTO SPKR LOOP 1 LOOP 2

2x6L6  
2x EL34 4x 6L6  
2x 6L6 2xEL+ 4x6L6

PROGRESSIVE LINKAGE REVERB

### CH 3



# FACTORY SAMPLE SETTINGS:

## CHANNEL 4 SETTING #1 Atlantic Blues

GAIN TREBLE MID BASS PRESENCE MASTER

RAW VINTAGE MODERN

RAW VINTAGE MODERN

**CH4**

DIODE A ON ON

TUBE-TRACKING B OFF OFF

RECTO SPKR LOOP 1 LOOP 2

2x6L6 2xEL34 4x6L6

2x EL34 2xEL+ 4x6L6

2x 6L6

PROGRESSIVE LINKAGE REVERB

**CH 4**

## CHANNEL 4 SETTING #2 Stripped Grind

GAIN TREBLE MID BASS PRESENCE MASTER

RAW VINTAGE MODERN

RAW VINTAGE MODERN

**CH4**

DIODE A ON ON

TUBE-TRACKING B OFF OFF

RECTO SPKR LOOP 1 LOOP 2

2x6L6 2xEL34 4x6L6

2x EL34 2xEL+ 4x6L6

2x 6L6

PROGRESSIVE LINKAGE REVERB

**CH 4**

## CHANNEL 4 SETTING #3 Hot Liquid Solo

GAIN TREBLE MID BASS PRESENCE MASTER

RAW VINTAGE MODERN

RAW VINTAGE MODERN

**CH4**

DIODE A ON ON

TUBE-TRACKING B OFF OFF

RECTO SPKR LOOP 1 LOOP 2

2x6L6 2xEL34 4x6L6

2x EL34 2xEL+ 4x6L6

2x 6L6

PROGRESSIVE LINKAGE REVERB

**CH 4**

## CHANNEL 4 SETTING #4 Recto Modern

GAIN TREBLE MID BASS PRESENCE MASTER

RAW VINTAGE MODERN

RAW VINTAGE MODERN

**CH4**

DIODE A ON ON

TUBE-TRACKING B OFF OFF

RECTO SPKR LOOP 1 LOOP 2

2x6L6 2xEL34 4x6L6

2x EL34 2xEL+ 4x6L6

2x 6L6

PROGRESSIVE LINKAGE REVERB

**CH 4**



**TUBE NOISE & MICROPHONICS:**

You may occasionally experience some form of tube noise or microphonics. Certainly no cause for alarm, this quirky behavior comes with the territory and the Tone. Much like changing a light bulb, you don't need a technician to cure these types of minor user serviceable annoyances and in fact, you'll be amazed at how easy it is to cure tube problems...by simply swapping out a pre-amp or power tube!

First may we suggest that you set the amplifier up on something so that you can get to the tubes comfortably without having to bend down. It also helps to have adequate lighting as you will need to see the tube sockets clearly to swap tubes. **Use caution and common sense when touching the tubes after the amplifier has been on as they may be extremely hot!** If they are hot and you don't want to wait for them to cool off, try grasping them with a rag and also note that the glass down around the bulbous silvery tip is considerably less hot which makes it easier to handle. Gently rock the tube back and forth as you pull it away from its socket.

**DIAGNOSING POWER TUBE FAILURE:**

There are two main types of tube faults: shorts and noise. Both large and small tubes may fall prey to either of these problems but diagnosis and remedy is usually simple.

If a fuse blows, the problem is most likely a shorted power tube and shorts can either be mild or severe. In a mildly shorted tube the electron flow has overcome the control grid and excess current flows to the plate. You will usually hear the amp become distorted and begin to hum slightly. If this occurs, quickly look at the power tubes as you switch the amp to STANDBY and try to identify one as glowing red hot. It is likely that two of a pair will be glowing since the "shorted" tube will pull down the bias for its adjacent mates, but one tube may be glowing hotter — and that one is the culprit. The other two are often fine — unless they've been glowing bright red for several minutes.

Because there is no physical short inside the tube (just electrons rioting out of control) merely switching to STANDBY for a few moments then back to ON will usually cure the problem...at least temporarily. Watch the tubes carefully now. Should the problem recur, the intermittent tube will visibly start to over heat before the others and thus it can be identified. It should be replaced with one from the same color batch, shown on its label. Call us and we will send one out to you.

The severe short is not nearly so benign. In the worst cases, a major arcing short occurs between the plate and the cathode with visible lightning inside the glass and a major noise through the speaker. If this is seen to happen, IMMEDIATELY turn the amp to STANDBY. By this time the fuse probably will have blown. Such a short is usually caused by a physical breakdown inside the tube including contaminate coming loose or physical contact (or near contact) between the elements. Replace it and the fuse with the proper slo-blo type and power up the amp using the power up procedure as we described earlier in this manual.

**TUBE NOISE:**

Often caused by contamination within a tube, the culprit can usually be identified, and by lightly tapping on the glass, you will probably hear the noise change. Hearing some noise through the speakers while tapping on the 12AX7's is normal however. And the one nearer the INPUT will always sound louder because its output is being further amplified by the second 12AX7.

The power tubes should be all but quiet when they are tapped. If crackling or hissing changes with the tapping, you have probably found the problem. To confirm a noisy power tube, merely put the *Road King* on Standby, remove it from its socket and turn it back on. It will cause no damage to run the *Road King* briefly with one power tube missing. You may notice a slight background hum, however, as the push-pull becomes unbalanced. Whenever you are trying to diagnose a suspect tube, keep your other hand on the POWER and STANDBY switches ready to shut them off instantly in the unlikely case you provoke a major short.

If you think you've located a problem tube but aren't sure, we recommend substituting the suspect with a new one just to be sure of your diagnoses. You will be doing yourself and us a big favor by just following the simple guidelines previously mentioned regarding tube replacement. You'll probably be successful with much less effort than is required to disconnect everything and haul the unit to a technician who will basically perform the same simple tests. If the tubes are still within their six-month warranty period, we will happily send you a replacement. Just note the color designation on the tube label so that we can send you the appropriate match.

**DIAGNOSING PRE-AMP TUBE PROBLEMS:**

Because your amplifier is an all tube design, it is quite possible that you will at some point experience minor pre-amp tube noise. Rest assured - this is no cause for alarm and you can take care of the problem yourself in a matter of minutes by simply swapping tubes.

Let us begin by saying; It is a "very good" idea to keep at least a couple of spare pre-amp tubes on hand at all times to insure uninterrupted performance. These minor pre-amp tube problems can take many forms but can generally be described in two categories: Noise and Microphonics. Noise can be in the form of crackling, sputtering, white noise/hiss and/or hum. Microphonic problems usually appear in the form of a ringing or high pitched squealing that gets worse as the gain or volume is increased thus are more noticeable in the higher gain "HI" modes. Microphonic problems are easily identified because the problem is still present even with the instruments' volume off or unplugged altogether - unlike pick-up feedback which ceases as the instrument is turned down. Microphonic noise is caused by mechanical vibration and shock: think of banging a microphone around and you'll understand where the word came from.

The best way to approach a pre-amp tube problem is to see if it occurs only in one specific mode or channel. This should lead you to the tube needing replacement. Then all that remains is to swap the suspect tube for a known good performer. If you cannot narrow down the trouble to a specific mode or channel, the problem may be the small tube that drives the power tubes which is operational in all modes and channels. Though rare, a problem with the driver tube would show up in all aspects of performance - so if you can't narrow the problem down to being mode or channel specific, you may want to try replacing the driver tube. Driver problems generally show themselves in the form of crackling or hum in all modes of performance and/or weak overall output from the amplifier. Occasionally an anemic driver tube will cause the amplifier to sound flat and lifeless, but this is somewhat uncommon, as worn power tubes are a more likely suspect for this type of problem.

Sometimes making the diagnosis is more trouble than it's worth and it's faster and easier to merely replace the small pre-amp tubes ONE AT A TIME with a replacement known to be good. But MAKE SURE you keep returning the tubes to their original socket until you hit the one that cures the problem. You'll notice that tubes located nearer to the INPUT jack always sound noisier...but this is because they are at the start of the chain and their noise gets amplified over and over by the tubes that follow. The tube that goes into this "input socket" (usually labeled V1) needs to be the least noisy of the bunch. The tube that goes at the end of the preamp chain - just ahead of the power tubes - can be quite noisy without causing any problem at all. The tubes in your amp have already been located in the most appropriate sockets and this is why you should NEVER pull them all out at once and ALWAYS swap them one at a time. ALWAYS return a perfectly good tube to its original socket. Also it's a good idea to put the amp on STANDBY when swapping tubes to reduce the heat build up in the tubes themselves and to prevent explosive noises (which can still occur even if you are pulling the tubes away from their sockets gently) from coming through the speaker.

Remember, take your time, be patient and chances are real good that you can fix your amp yourself by finding and replacing the bad tube. It kills us to see someone who has shipped their amp back to us...and all it needed was a simple tube replacement! If you must send back your amp, remove the chassis from the cabinet by unscrewing the four mounting bolts on the bottom top. The chassis then slides back like a drawer and comes out from the back. Remove the big power tubes and mark them according to their location from left to right 1, 2 etc. They need to be wrapped separately with plenty of wadded up newspaper around them and put in a smaller box within the larger carton. Remove the Rectifier tubes and wrap them also. You can leave the preamp tubes in or remove them and wrap them separately being sure to label their location. (See Tube Task Chart.)

To wrap the chassis, use plenty of tightly wadded up newspaper so there is at least six inches of "crush space" between the chassis and the cardboard box. Bubble wrap also works well, but please DON'T use styrene peanuts - they will shift during transit and get lodged inside your electronics as well as allowing your amp to end up at the bottom of the box unprotected and possibly damaged.

Pre-amp tubes don't normally wear out as a rule. Therefore, it is not a good idea to change them just for the sake of changing them. If there isn't a problem - don't fix it. If there is no result from your substitutions, it may be possible that you have more than one problematic tube. Though rare, this does happen and though it makes the troubleshooting process a little more intimidating, it is still possible to cure the problem yourself.

**NOTE:** *It is normal to hear a slight metallic ringing sound when tapping on the preamp tubes. As long as the tube does not break into oscillation or start crackling or any other form of bizarre noise, it is considered normal and functional.*

**BIAS ADJUSTMENT:** (Part of a continuing series)

An Article written by Randall Smith that we thought you might find interesting.

Here's a question we often hear:

"Why doesn't *Mesa* put bias adjustments in their amplifiers?"

Well, there's a short answer and a long answer to this question.

The short answer is that during my 12 years of repairing Fenders, one of the most frequent problems I saw was bias controls that were either set wrong or that had wandered out of adjustment due to vibration. As any honest tech will tell you, there's lot's of easy money to be made by sprinkling "holy water" on amplifiers ... uh, what I meant to say is "Your amp needed biasing." See what I mean? What customer is going to argue with that?

It only takes a moment and a volt meter: The Fender diagram shows how: "Adjust this trim pot for - 52 volts." That's it. Nothing more.

Now don't be fooled into thinking that tubes "draw" more or less bias, they don't. The way a bias supply is connected to a tube is akin to a dead end road, it just trails off to nowhere without really completing a circuit. It's a static voltage and regardless of what tube is in the socket — or even if the tubes aren't plugged in at all, it doesn't change the bias voltage a bit.

So the end of the short answer is this: Since a bias supply needs to put out the right voltage and never vary, I wanted to build amplifiers that were individually hard wired to the correct values and NEVER needed adjustment. And for 25 years, that's how *MESA/Boogies* have been built.

Time to change tubes? Just plug our tubes into any one of our amps and you're DONE. No tech needed. NO bills and no BS about biasing. And most important: The bias is RIGHT because it can't change!

Now, you want the long answer? Here's more information on how our hard-wired bias avoids trouble. Please read on.

But first, let's make an important distinction. Our business is designing and building high performance amplifiers. And for this we need tubes whose variance is within a narrow range. Our warehouse is full of rejects ...oh, they work — they just don't perform within our tolerance range. We have a very sophisticated computer - based tube testing system (nicknamed "Robotube") that matches and measures tubes over seven important parameters. It can even predict which tubes are likely to have a shortened lifetime — even though they work perfectly during the test.

Because our business is building quality amps, we can afford to reject a lot of wayward tubes. The guys you hear complaining because *Boogies* don't have bias adjusters are primarily in the business of selling tubes - not amps. They don't want to throw away 30 percent of their inventory, so they promote the idea that tubes outside our parameters can be used to "customize" amplifiers and they criticize us because our amps can't be adjusted to accommodate their out-of-*MESA* tolerance tubes.

Now you might be thinking, "But I thought you just said that tubes don't "draw" bias, therefore they don't effect the bias supply and thus it doesn't need to be adjustable." When you set the bias (whether it's by selecting the right resistors, as we do, or adjusting a trimmer — which is quicker) what you are doing is establishing the correct amount of idle CURRENT that flows through the power tubes. But you can't adjust the current directly, you can only change it by adjusting the amount of bias VOLTAGE that goes onto the tubes'

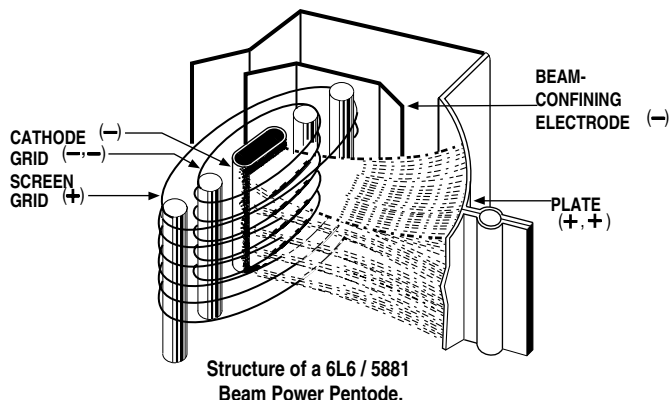

**BIAS ADJUSTMENT:** *(Continued)* control grids. Voltage and current are NOT the same. Current is the AMOUNT of electricity, the “quantity” — and is measured in amperes. Voltage is the degree of electric charge — like the “pressure” to use the old water analogy. Let me illustrate how different voltage and current are:

When you scrape your feet across a carpeted floor in dry, wintery conditions, your body can become charged with 50,000 to 100,000 volts of static electricity. And when you reach for the door knob, a spark jumps and you feel it! The voltage is super high but the current (measured in micro-amps) is tiny - otherwise you would die from electrocution.

Contrast this with your car battery, which puts out a mere 12 volts. You can lay your hands right across the terminals and not feel a thing. Yet the amount of current available can run to several hundred amperes .. enough to turn over a cold engine and get it started.

So current and voltage are two totally separate electrical parameters — though when you multiply them together, you get POWER, which is measured in watts.

When you set the bias of an amplifier, you are adjusting the static VOLTAGE at the control grid of the tube in order to produce a desired amount of idle CURRENT flowing to the tube’s plate. A small change in grid voltage, produces a large change in the amount of current flowing — and that’s basically how a tube works. Say that again because it’s super important: A small change in voltage at the grid causes a large change in current flowing to the plate. See, that’s the essence of amplification: A small change causing a large change. And here it’s a small voltage change causing a large current change.

The bias conditions are what determines how much current flows through the big power tubes when you’re not playing. And what drives your speakers is fluctuations in that current flow when you ARE playing. If the amount of current increases and decreases 440 times per second, then you’ll hear an A note. If the fluctuations in current flow are large and still at 440 per second, you’ll hear an A that is LOUD!

But for purposes of biasing, it’s the amount of “plate current” flowing with no signal applied that’s important. Unfortunately current is hard to measure because the circuit must be interrupted — as in “cut the wire” — and the meter spliced “in series” with the broken circuit. But measuring VOLTAGE is easy. It is not necessary to interrupt the circuit because a voltage reading can be taken in PARALLEL with the circuit intact.

Thus, as a matter of convenience, most bias settings are given in volts at the grid ... even though current through the plate is the important factor. In fact plate current is so inconvenient (and dangerous) to measure that Fender doesn’t even state what the correct value should be. They only give the grid voltage that will produce that current. (That’s the minus 52.) But that only happens if the tubes being used are “in spec.”

As long as the tubes ARE “in spec”, the right bias voltage will always give the correct plate “CURRENT” — but then there’s no need for the bias voltage to be adjustable!

If the tubes are NOT in spec, then the only proper way to re-set the bias is to cut the circuit and measure the current while adjusting the bias ... but no manufacturer I know even STATES the desired current value! Be that as it may, when the original bias voltage is altered far enough, it will compensate for the tube’s abnormal performance and the correct amount of idle current flow may then be restored. Clearly this is something most repair techs should not attempt.

Some newer amps have LED indicators connected to the circuit which will turn on when the right threshold of current flow has been reached. This is an improvement, and almost worthy if you’re willing to accept resistors and lights added into your amplifier’s audio path — which we aren’t.

The other “advantage” of this system is that it allows some amp manufacturers to avoid matching their power tubes. The thinking is that adjusting the bias to each tube separately eradicates the inherent differences between the tubes by insuring that the same current flows through each one.

**BIAS ADJUSTMENT:** *(Continued)* Again, this has some merit .. but it's still not as good as using tubes that are matched in the first place because compensating for the mis-match causes the push-pull circuit itself to become unbalanced. Two wrongs don't really make a right.

Some of the other recommended biasing, "methods" — such as -".. tubes running red hot, increase the bias .. sounds harsh and runs too cool, turn it down ..." are guesswork at best. Luckily, one of the great things about tube amps is that they can usually stand some abuse without causing any real harm ... at least not immediately. But don't these alterations imply that you are second-guessing the amp designer and that there's a better set of operating conditions that the designer missed but the tube sellers have discovered?

Now some players may like the sound of their amp altered by tubes with extreme characteristics and with the bias set to help compensate. But often it is the mere novelty of change that they're really responding to and when the amp goes back to the proper original way, we've seen them be far happier still!

Because every part in every one of our designs has been meticulously evaluated, compared and stressed over — no matter how seemingly insignificant it might be. And with every design we look for a "sweet spot" where all the parameters — including the bias — come together to give the best sonic performance, consistently and reliably. Every part and voltage is important — yet no one complains that these other parameters aren't available for tinkering.

Consider our patented *Simul-Class* circuitry where there are two different bias voltages used for separate pairs of power tubes ... and changing one voltage also changes the other. Great care goes into getting this just right and we think we'd be asking for trouble to have it adjustable for the world to play with ... unless you like paying to have your amp messed up. Sorry, I meant to say, "Uh, ... your amp needed biasing."

If that doesn't appeal to you, then merely plug a matched set of *MESA* tubes into one of our amps and you're ready for tone. Guaranteed. You'd be amazed at the number of service calls we field every day that lead to a diagnosis of out-of-tolerance, non-spec tube problems. To think these would be prevented by including a bias adjustment is something of an insult to you and us. If you put the wrong size tires on your car, do you think changing the pressure will make them right?

Please, don't think this is a blanket indictment of the other guys selling tubes — it isn't. And their tubes aren't all bad either. It just doesn't make sense to pay more of your hard earned cash for tubes that were probably made in the same Russian or Chinese factory and which have the possibility of being outside the performance window we select for your amp. And it pains us to hear the hype and mystique built up around biasing when twenty-five years of evidence affirms our decision to make bias circuits that "never need adjustment". How much money and trouble that has saved *MESA/Boogie* players you couldn't estimate.

Our rigorously tested and hand selected tubes are available at your nearest *MESA/Boogie* Pro Center or from us directly. Nobody offers better price, quality or warranty than we do ... so why swerve?

Next time we'll talk about our part in developing the great Sylvania STR 415 type 6L6 and how we're on the verge of seeing something fairly close reappear on the market. Remember, we still have some of these super rugged mondo-bottles available for older amps — *Boogies* only please! Until then, Relax, Breathe and Nourish your soul!

Cheers!

*MESA/Boogie Ltd.*

## SPEAKER IMPEDANCE MATCHING & HOOK-UP GUIDE:

**IMPEDANCE:** Wiring up speakers to provide the most effective load and making sure that all of them are in phase will help in creating the best sound possible. This is not too difficult, as long as you understand a few things about loading and how to connect your speakers to provide an optimal resistive load.

*MESA/Boogie* amplifiers can handle 4 and 8 ohms effectively. Never run below 4 ohms in a tube amplifier unless you are absolutely certain that the system can handle it properly; this can cause damage to the Output transformer. A few amplifiers can handle 2 ohms effectively without damaging them ( for example the *MESA'S Bass 400+* ). You can always have a higher resistance ( 16 ohms, for example ) without damaging results, but too low of a resistance will likely cause problems.

**MIS-MATCHING:** When running a higher resistance ( for example: 8 ohm output into 16 ohm cabinet ), a slightly different feel and response will be eminent. A slight mismatch can provide a darker smoother tone with a little less output and attack. This response is a result of the amplifier running a bit cooler. Sometimes when using more than one cabinet a mismatch will be the only option.

**WHAT IS MY CABINETS IMPEDANCE:** If you have only a single speaker, you just match that single speakers impedance to the amplifier, and you are done. In many cases, you will have a number of speakers, and then you must calculate the "load" that the amplifier will need to support. There are generally three ways to wire multiple speakers together. They are as follows:

**SERIES:** When you wire ( hook-up ) speakers in Series, the speakers resistance ( as measured in ohms ) is additive - i.e. putting two 8 ohm speakers in Series results in a 16 ohm load.

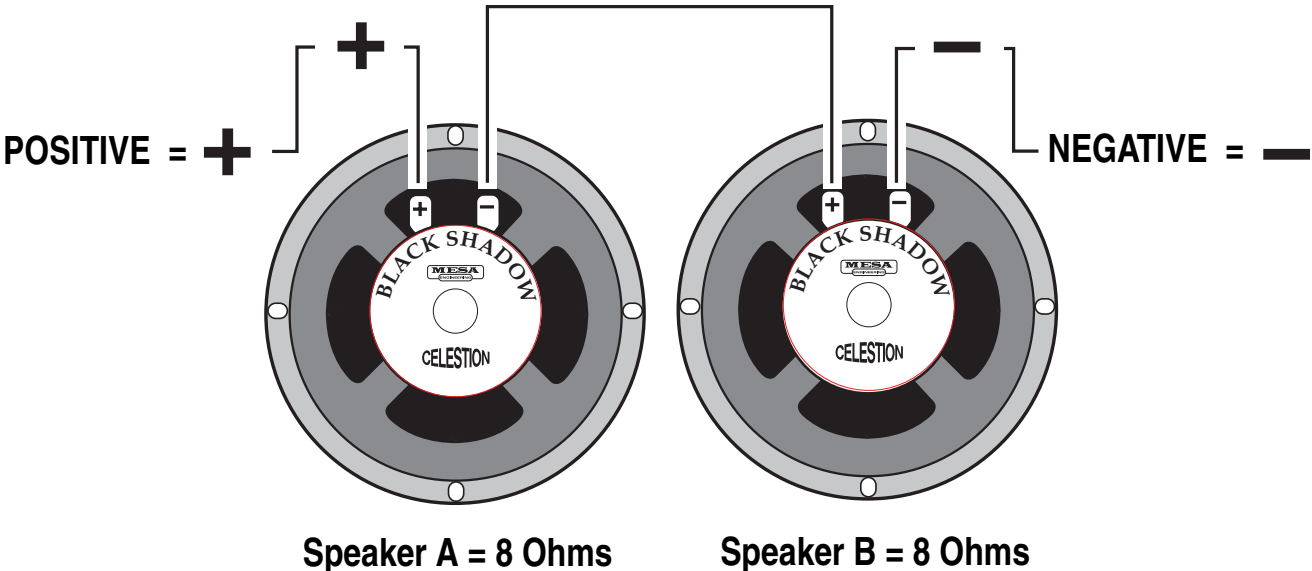

**SERIES:** Connect the Negative side of Speaker A to the Positive side of Speaker B



## SPEAKER IMPEDANCE MATCHING & HOOK-UP GUIDE: (Continued)

**PARALLEL:** When wiring in parallel, the resistance of the speakers decreases. Two 8 ohm speakers wired in ( hooked-up ) Parallel results in a 4 ohm load. It's easy to calculate the effect of a resistive load when all the speakers are all the same resistance. It is really not suggested to wire different resistive load values in Parallel ( 8 and 4, 16 and 8 etc. ) The formula for figuring the total impedance in Parallel is the multiplication of the two loads divided by the sum of the two loads - i.e. putting two 8 ohm speakers in Parallel results in a 4 ohm load. Connect the Positive side of Speaker A to the Positive side of Speaker B - Connect the Negative side of Speaker A to the Negative side of Speaker B.

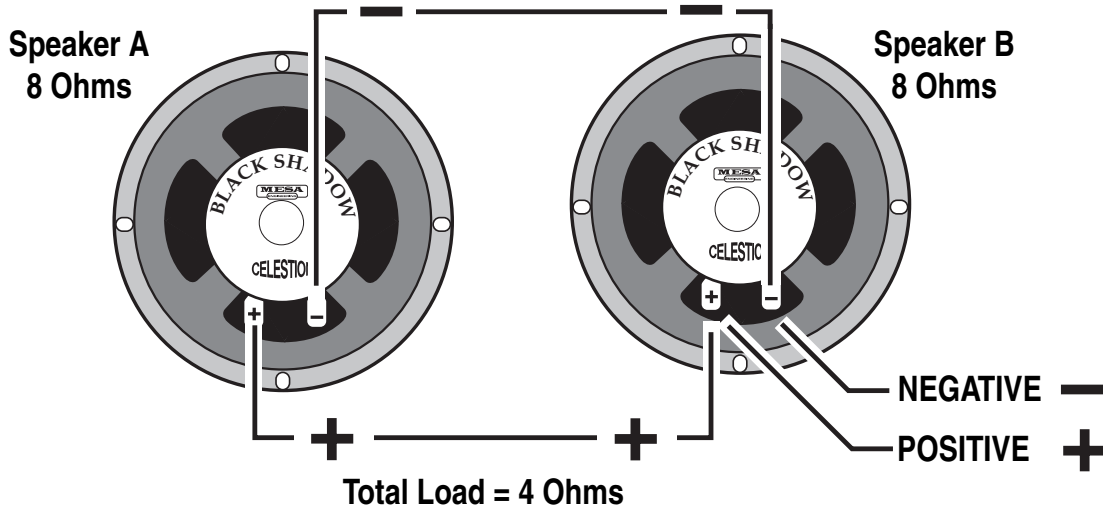

**COMBINATION OF SERIES & PARALLEL:** This is really just two sets of Series wired speakers connected in Parallel. This is how you maintain a consistent load with multiple speakers. The importance of this is more evident when you have more than one cabinet to connect to your amplifier. This is when you need to figure out the loads and how to wire them up without applying too low of a resistance on the amplifier.

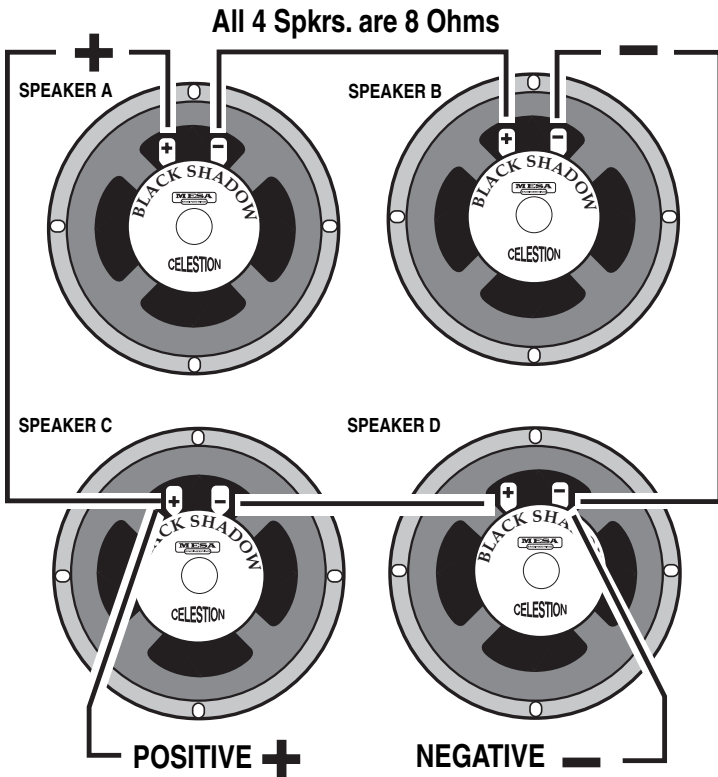

Simply connect the Positive side of Speaker A to the Positive side of Speaker C.

Connect the Negative side of Speaker A to the Positive side of Speaker B. Next, connect the Negative side of Speaker B to the Negative side of Speaker D.

And lastly, connect the Positive side of Speaker D to the Negative side of Speaker C.

4 Eight ( 8 ) Ohm speakers wired in Series Parallel = a Total Load of 8 Ohms.

# WIRING SCHEMES...Amplifier to Speaker Cabinets

1

2

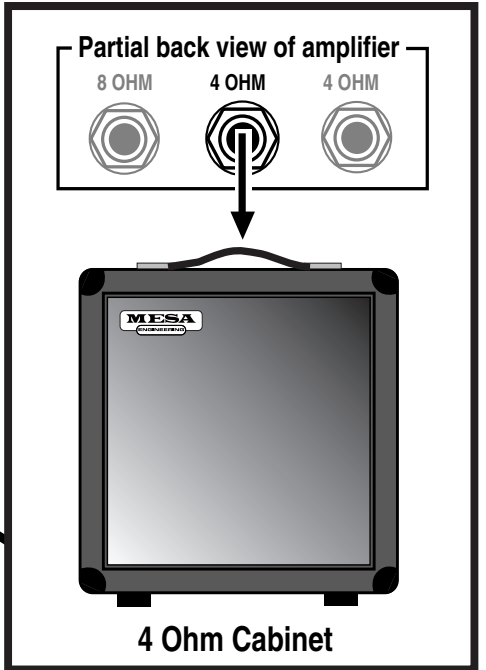
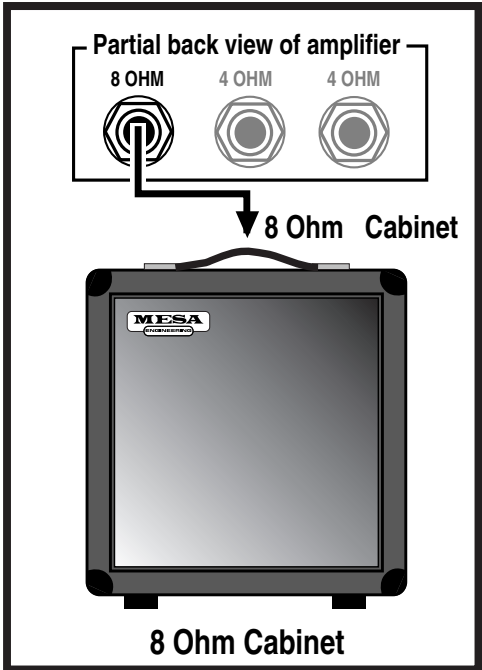

3

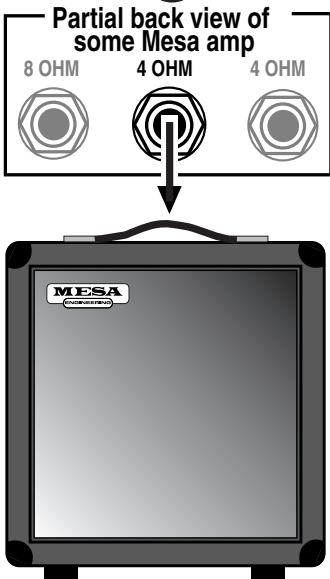

4

5

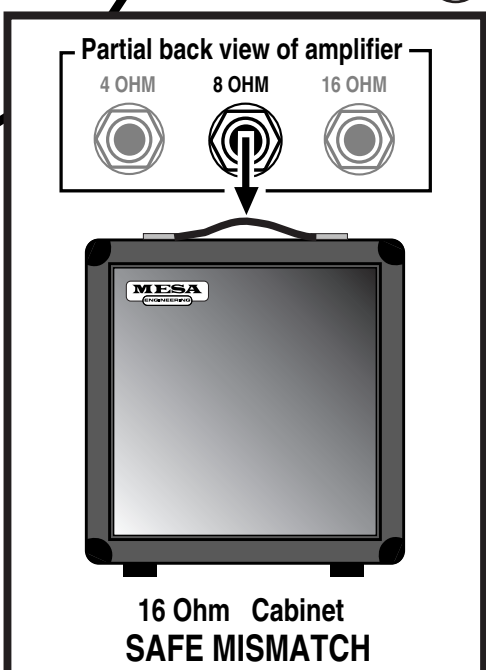
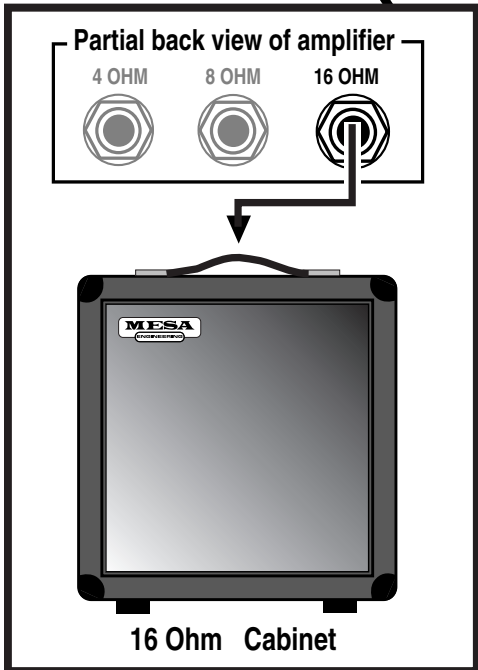



# WIRING SCHEMES...Amplifier to Speaker Cabinets

6

7

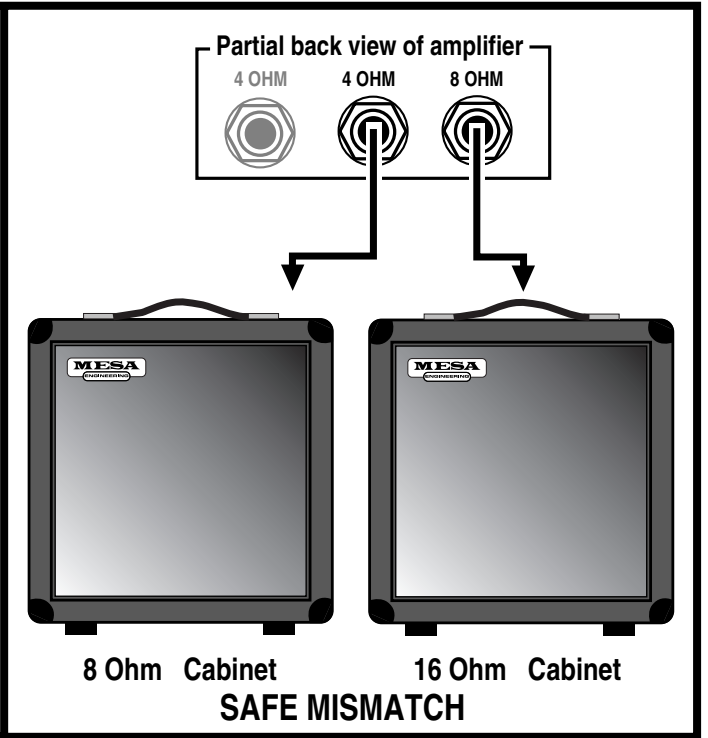
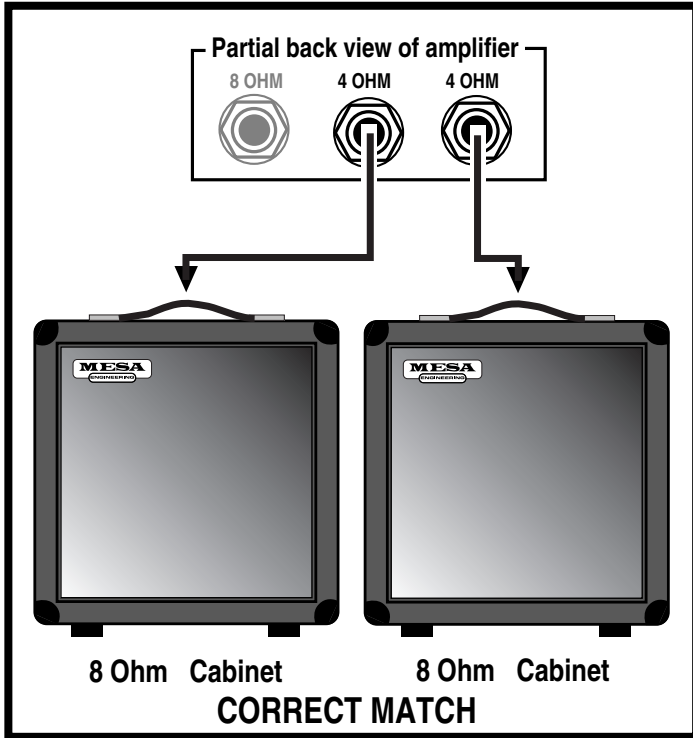

8

9

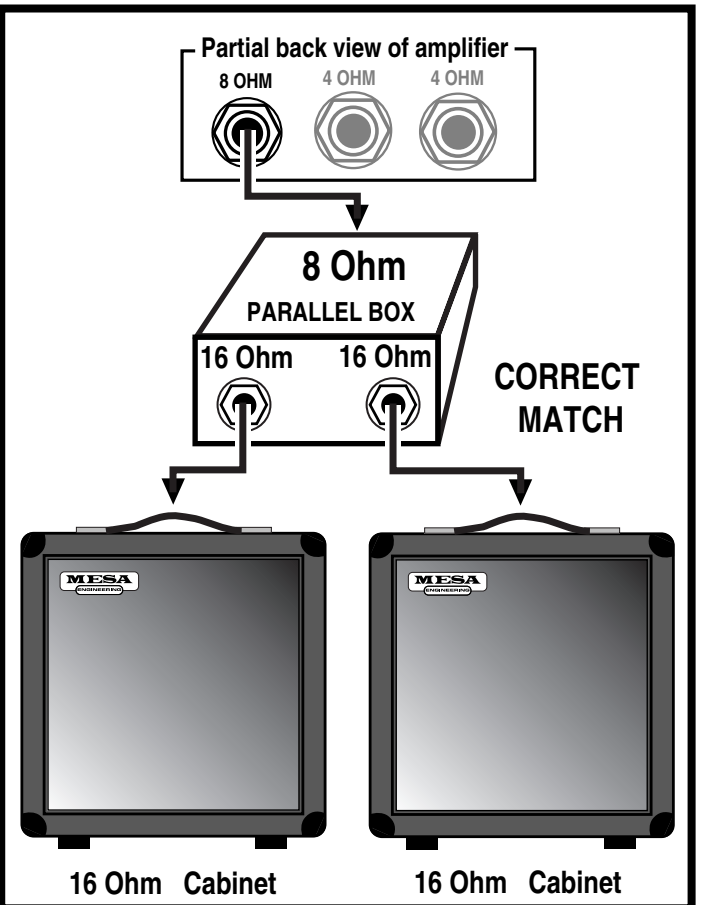
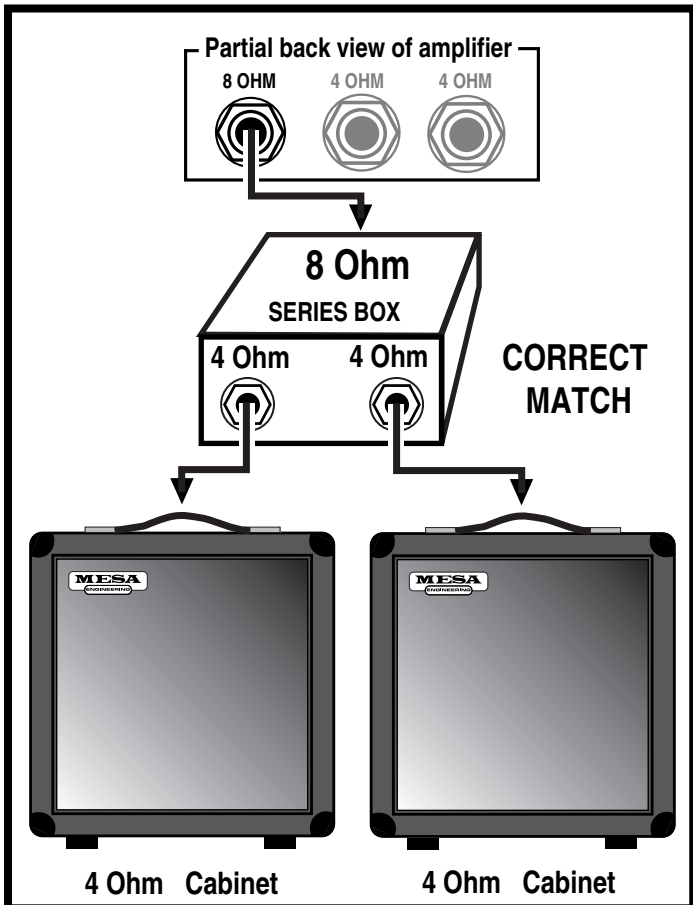

# WIRING SCHEMES...Amplifier to Speaker Cabinets

10

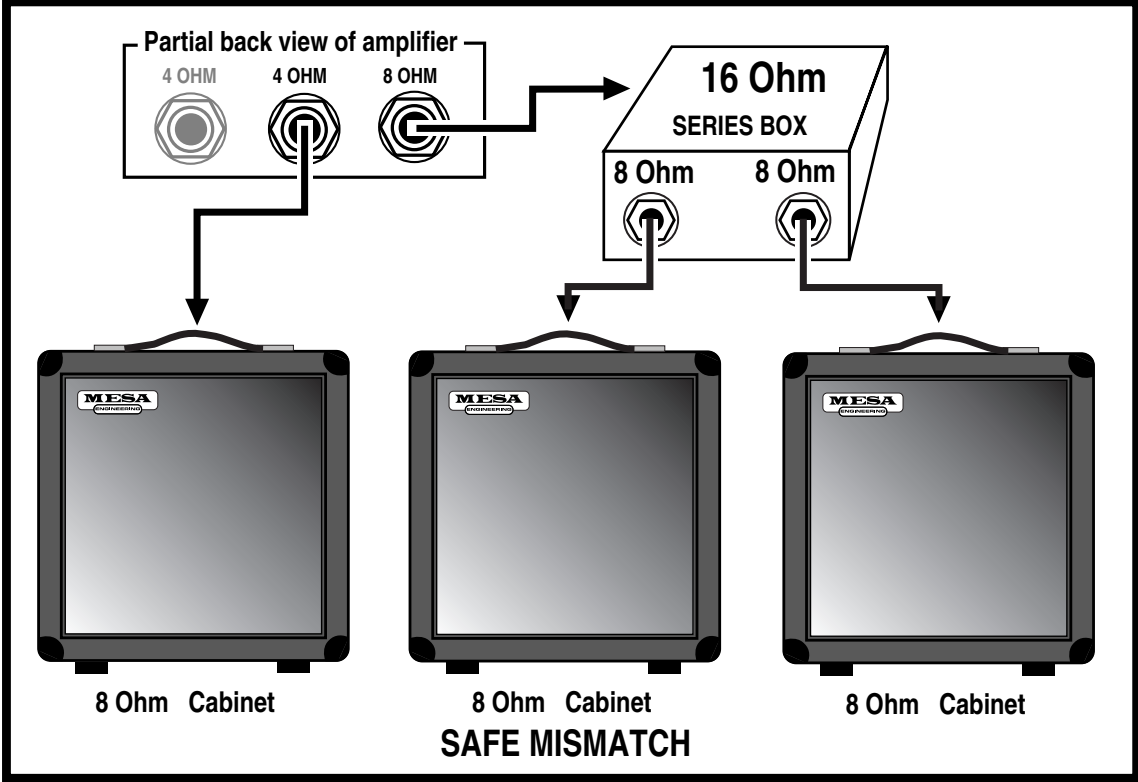

11

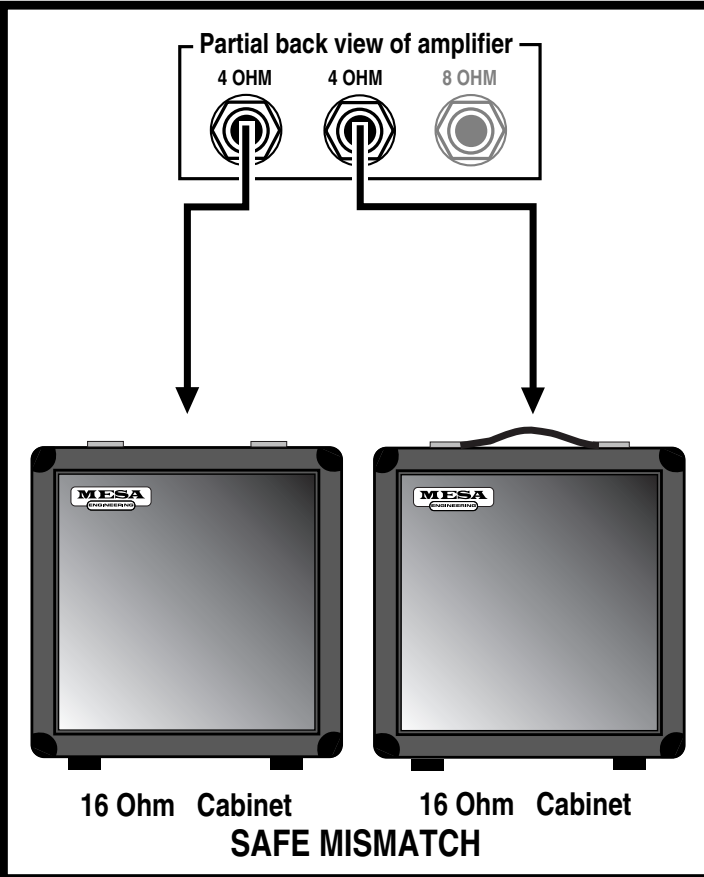

12

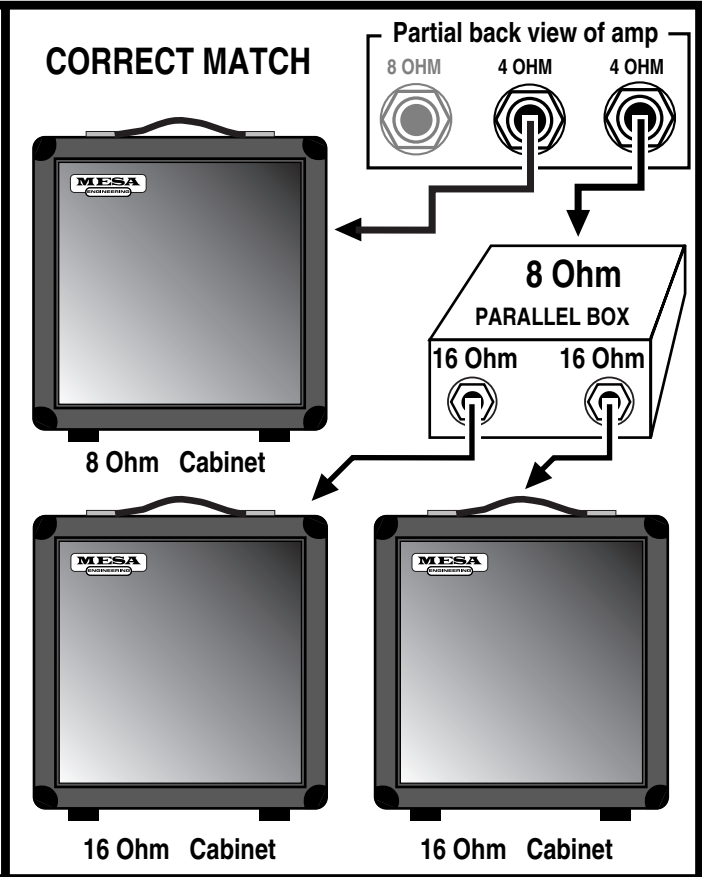

# WIRING SCHEMES...Amplifier to Speaker Cabinets

13

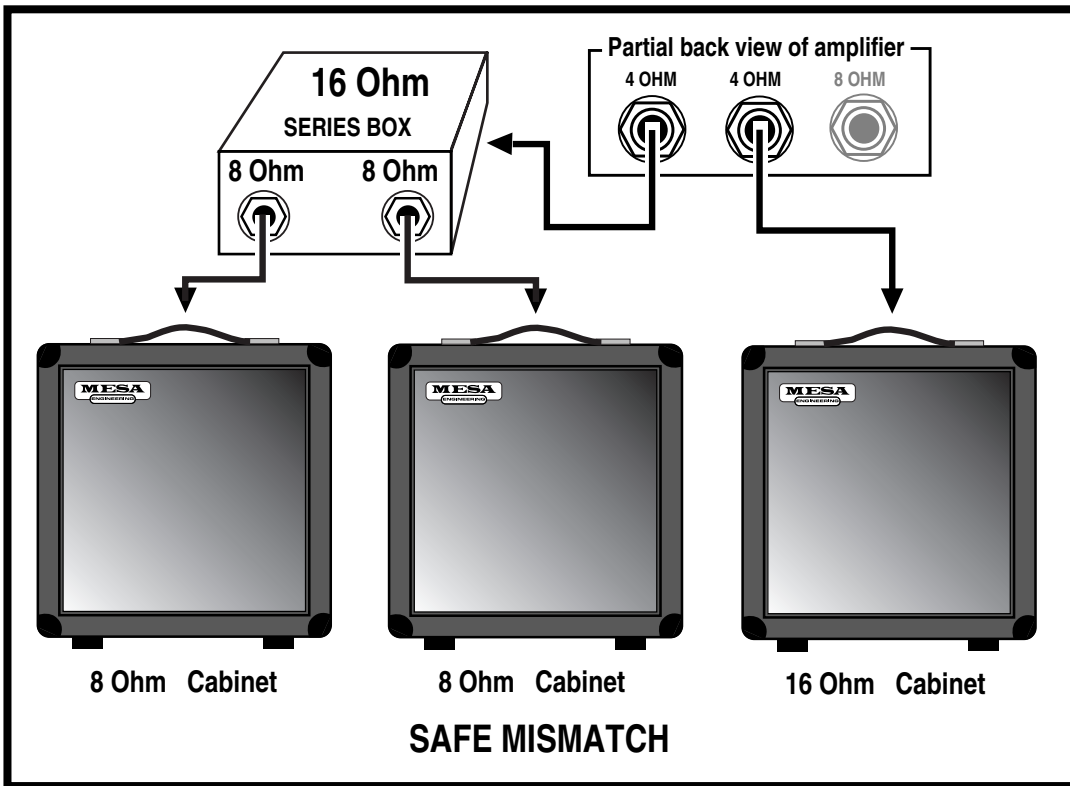

14

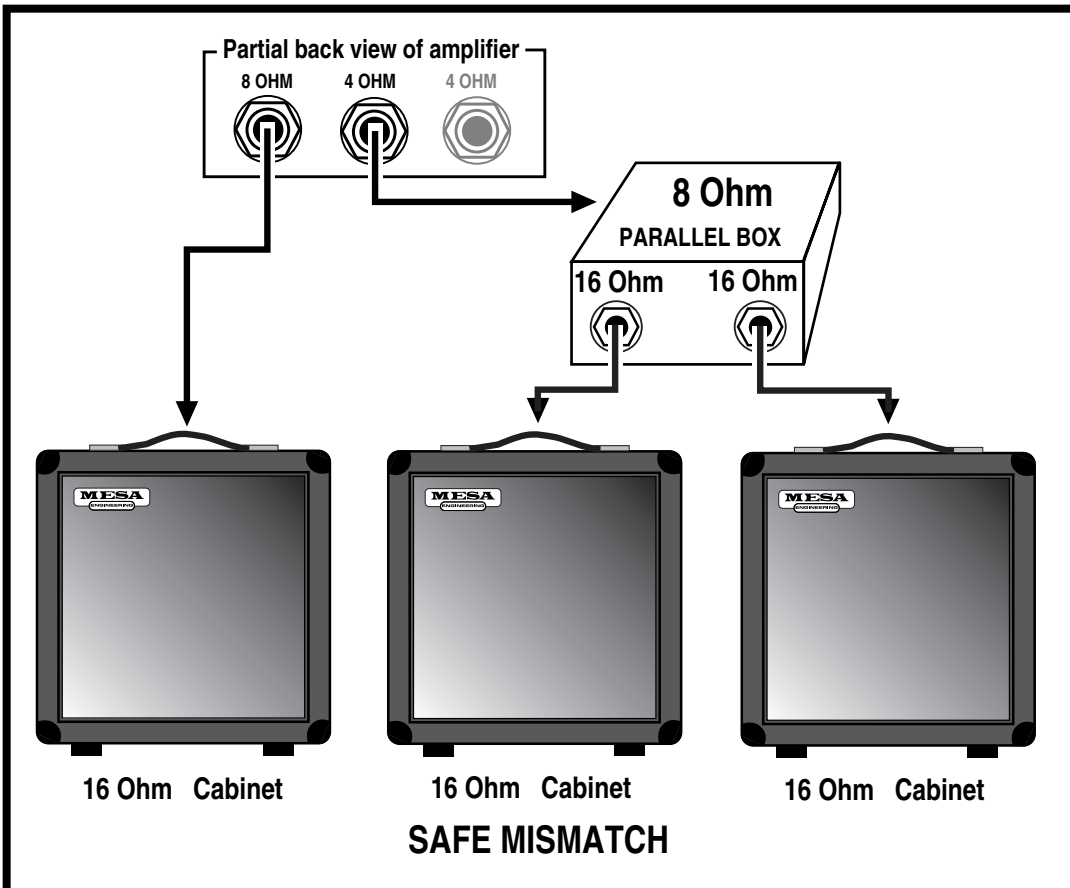

## ON TRIODES, PENTODES & IRISHMEN:

With apologies to Friends and Relatives from the Emerald Isle - who will make their appearance soon enough - the humor which follows is dedicated to the memories of Spec McAuliff and Fae (Rafael) McNally, two of the True Greats.

As their numerical references suggest, the terms Diode, Triode and Pentode indicate the number of elements within the vacuum tube i.e. two, three or five. All tubes also require a filament or heater which is not included in the count. Its purpose is to excite electrons from the cathode coating by raising the temperature such that they are able to boil out of the electron-rich coating material and form a cloud of free electrons in the vacuum space surrounding the cathode.

Although the term filament and heater are often used interchangeably, there are specific differences: A filament is a directly heated cathode where cathode coating is applied directly to the heating element. Examples are 5U4 twin diode rectifier and 300B triode amplifier tubes. A heater, on the other hand, is a heating element which is separate from the cathode and is usually inserted within the tubular cathode sleeve. Examples are 12AX7 twin triode amplifier and 6V6 or EL84 beam power pentode tubes. In all cases this fundamental aspect of each tube's construction is clearly visible, especially when the heating element is glowing red hot.

The cathode, then, would be considered the first numbered element because it is the source of the electrons. The word itself is from the Greek literally meaning completely down, which implies a sense of central origin - like the center of the earth where Tone begins. It might be said that an ecstatic audiophile experiences a positive catharsis, his soul being purified when his system transports him to Audio Nirvana. The only trouble with taking this positive imagery too far is that the cathode is, unfortunately, negative... at least electrically speaking. However this is easily remembered since virtually all musicians and audiophiles have also experienced the more common negative catharsis when they emerge from the emotional rebirth kicking and screaming in rage and frustration.

Once heated, the intrinsically negative electrons are energetic little fellows of almost no mass. Thus they may be accelerated almost instantaneously and will travel through a vacuum a nearly the speed of light. Being of like, negative charge, they tend to repel one another and thus within the electron cloud surrounding the cathode, there is much jostling and elbowing as each one tries to maintain his distance from all the others... unless there is a strong and universal attraction from an outside influence.

Visualize, if you will, a group of sub-atomic Irishmen milling about and in a repellent, negative state of mind. All are scowling and none wants to have anything to do with the other. Now introduce a strong attraction say, a public bar, and you can easily picture an orderly, if rapid movement of the lot in a single direction. This is what happens when a positively charged element called the anode or plate is introduced into the vacuum.

The plate is the large metal element most prominently visible through the glass of an electron tube. It is the outermost element of a tube's structure and it surrounds all the others. The cathode is at the center radiating electrons outwards. As higher and higher positive voltage is applied to the plate, the attraction for the electrons surrounding the cathode is increased and with nothing standing in the way, full uninhibited flow to the plate occurs... sort of like removing the doors and offering free drinks to the crowd of surly Irishmen milling around outside. As electrons flow to the plate, the space charge will continually be replenished by further 'boiling' of the hot, electron-rich cathode as you can easily imagine other Irishmen impatiently taking up the places of those who've gone inside - until the entire village is deserted.

Now, where do they come from and how do they emerge? Well, a grand and elegant lady once showed me how to revive flat champagne: She dropped a raisin into the glass. There was a dramatic and immediate increase in effervescence with the introduction of a cathoding surface. Thousands of tiny bubbles suddenly appeared - and continued to flow from the raisin. Of course the bubbles were made up of gas dissolved in the beverage, but the analogy makes it easy to visualize the loosely bound electrons dissolved in the rich cathode coating as they effervesce from its heated surface.

But back to the electron flow. If the electrons are strongly attracted to a positively charged plate, then it follows that they are strongly repelled by a negatively charged plate and they are. Thus, if an alternating current - such as comes from a transformer - is applied to the plate, electrons will flow only during the times when the plate is positively charged. During periods of negative plate charge, electron flow is stopped and the space charge of electrons remains compressed in the area around the cathode.

**ON TRIODES, PENTODES & IRISHMEN: (Continued)**

Thus a diode tube - one with a cathode and an anode - is mostly used to rectify alternating current into direct current by passing it without restriction, but in one direction only. This also explains why closing time is strictly enforced at Irish pubs: During normal operation, the traffic flow is similarly unimpeded and uni-directional toward the bar and this process rectifies the work-day negativity. It goes without saying that no one leaves as long as the atmosphere around the bar remains positively charged.

**TRIODES:**

This section is a continuing technical treatise on the workings of Irish Pubs but to make it easier for the layman to understand, it is explained in terms of vacuum tube technology. Enter the original bar - free beer and no doors. Well, it turns out that some control over the flow can be a necessary and useful advantage. This led to the invention of those swinging louvered saloon doors which are open at the top and bottom. They are patterned after the control grid of the vacuum tube, which is a loosely wound coil of thin wire located between the cathode and the plate.

In a Triode the plate is always positively charged with high voltage D.C. and even though the grid is blocking the path, those negative electrons can still FEEL the strong attraction - just as the Irishmen can see in through the louvers of the bar doors. They know what pleasures lie beyond, but to get there requires overcoming the negative influences controlling the access. This negative influence is typically called a Bias. In electronic terms that means the grid is supplied with a voltage which is slightly MORE NEGATIVE than the already negative electrons. The more negative the Bias, the more it tends to neutralize the attraction of the plate and repel the electrons back toward the cathode.

The Irish can be similarly charged with Bias, but unless you are Irish yourself, this type of Biasing may be more difficult to understand. The effect is similar though: The more negative the Bias, the more it impedes forward progress. Generally speaking though, the electronic Bias of the grid is easiest to overcome, and for two main reasons: First, the Bias is set - like the bar doors - to allow some passage. Second, the grid is mostly NOT THERE, like the louvered doors which are mostly open spaces. Unlike the plate which is solid, the grid is like a coiled bed spring. It can create a repelling field but mostly it's empty space in between widely separated windings of wire. It's very easy to control the electrons as they pass through the grid's force field: Changing the grid voltage only slightly will have an enormous effect on how much current flows through... and that's what AMPLIFICATION is: a small change in voltage at the grid causing a large change in current flowing to the plate.

The purpose of the louvered bar doors is similar to that of the grid, namely, to give momentary pause while still revealing the promise within. Hesitation mostly gives way to temptation, but there are those few stalwart Irishmen who think twice and decide to come back later. Most just pause slightly then go on through. That is the purpose of the bar doors: to prevent everyone from crowding in all at once - and as the door is made less of a barrier, wider spaces between the louvers, more of the bar's attractive influence is felt outside thus amplifying the customer flow and increasing the crowd at the bar.

**PENTODES:**

Occasionally though, bar doors - even the louvered type - were found to be too effective, and too many customers turned away. Something further was needed to increase the attraction of the bar and overcome the resistance created by the door. Thus the cocktail waitress was invented.

Once again the idea was inspired by the vacuum tube. It had been discovered in some tubes, often large power types, that the distance to the plate was too great to attract enough electrons past the negative influence of the control grid. So another grid coil of fine wire was inserted between the first grid and the plate. This was called the screen grid and carrying a highly positive charge, it functioned as a "bait" for the plate.

In a properly designed power tube such as an EL84 or a 6V6, the windings of the screen grid are precisely aligned to fall in the shadow of the control grid. This way the electrons responding to the pull of the screen grid are lined up in sheets as they pass between windings of the inner control grid... only to find that they have been fooled! Once past the control grid and drawn toward the screen grid, they discover...there's almost nothing there. The path they're on has them aligned to zing straight through the spaces BETWEEN screen grid windings. So rather than a close and personal encounter, they just fly on past - and once they're out that far, there's no stopping them. The influence of the plate takes over and - being solid metal and of the highest positive attraction - it is at this final destination that the electrons congregate.

**PENTODES:** *(Continued)*

Thus the proper cocktail waitress - visible through the louvers - is scantily clad so as to be all the more effective at reinforcing the attractive influence of her bar and by being located in between the door and the bar, she serves as bait to lure customers past the door's negative influence. Once through the door however, it is the rare Irishman who actually comes in personal contact with the cocktail waitress as, for all intents and purposes, she - like the screen grid - turns out to be a vanishing illusion. Yet, having come this far, the solid influence of the bar itself now takes over and attracts the customers to congregate, having happily reached their destination.

If you're still following this and haven't lost track of the count, you'll know we're still one element short of the five needed to make a Pentode. This last part is a pair of beam-confining shields which being negatively charged, serve to direct the flow right toward the plate. This is much the way a short entrance hall to the bar prevents wandering accidentally into the Men's room on the way.

Once at the bar though, the circuit is complete and the process of soul-nourishing works its ritual magic. Biases having been overcome, illusory nightingales having vanished, the spirits truly soar and the once surly Irishmen now are filled with warmth, wit and kindred friendship, enjoying the music and glowing nicely with their heaters on.

With appreciative thanks to the inhabitants of the Land of the Leprechaun, we have now concluded our little diversion into the mechanics of proper bar lay-out.

A feature article by Randall Smith  
Designer / President



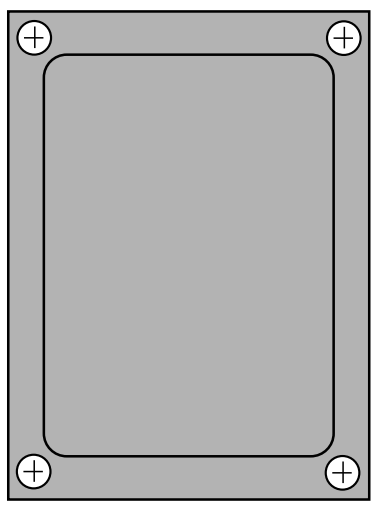
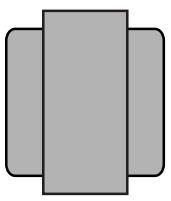
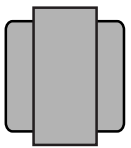

12 AX7



12 AX7



12 AX7



12 AX7



12 AX7



12 AX7

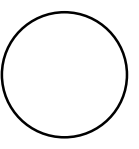
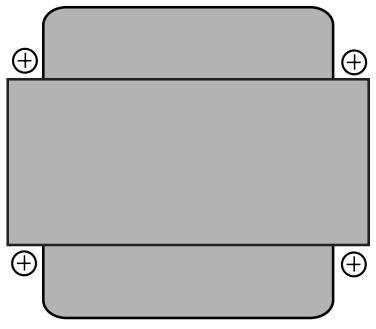

EL34

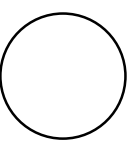

EL34

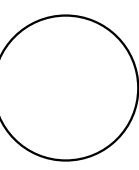

6L6

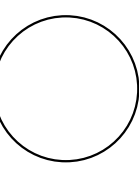

6L6

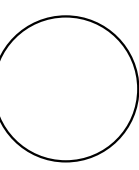

6L6

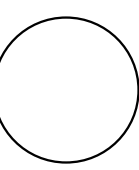

6L6

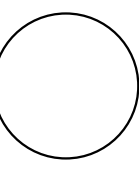

5U4

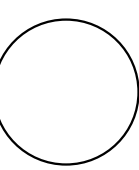

5U4

**Description of Tube Functions**

- V1 A= First Gain Stage
- V1 B= Second Gain Stage
- V2 A= 3rd Gain Stage - Ch 1 & 2
- V2 B= 3rd Gain Stage - Ch 3 & 4
- V3 A= 4th Gain Stage - Ch 3 & 4
- V3 B= Tone Stack Driver - Ch 3 & 4
- V4 A= Reverb Return
- V4 B= Reverb Driver
- V5 A= FX Loop Send
- V5 B= FX Loop Return
- V6 A= Phase Inverter / Driver
- V6 B= Phase Inverter / Driver



# ***MESA/BOOGIE***

*The Spirit of Art in Technology*

*Thank you for trusting MESA/Boogie to be your amplifier company and we wish you many years of toneful enjoyment from this handbuilt all tube instrument.*

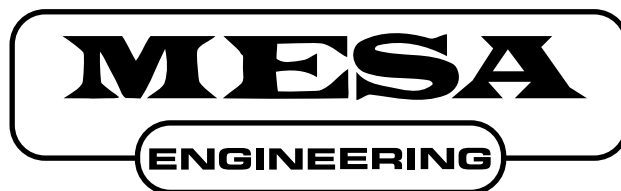

*The Spirit of Art in Technology*

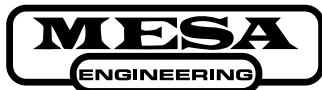

*(707) 778-6565      FAX NO. (707) 765-1503*  
*1317 Ross Street Petaluma, CA 94954*  
*USA*