



DELUXE TILTING DESKTOP MONITOR STANDS

MS-20

USER MANUAL



**DELUXE
DESKTOP
MONITOR
STANDS**



INTRODUCTION

Thank you for purchasing the Deluxe Tilting Desktop Monitor Stands by Gear4music. To get the most out of your product, please read this manual carefully.



BOX CONTENTS

- 2 x Rubber cap (1)
- 2 x Top speaker plate (2)
- 2 x Base plate (3)
- 2 x Stand (4)
- 8 x Allen screw (5)
- 2 x Cable clip (6)
- 1 x Allen key

FEATURES

- Premium height adjustable stands suitable for most studio monitors.
- Non-slip rubber pads ensure secure positioning.
- Long-lasting life via sturdy, all metal construction.
- Instantly adjust the stands to the perfect listening angle.

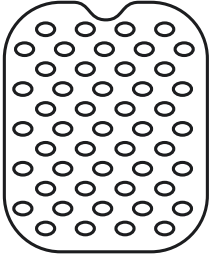
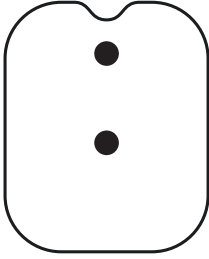
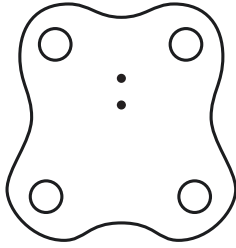
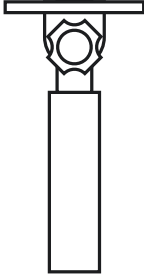
CONTENTS CHECKLIST

<p>ITEM 1</p>  <p>X2</p>	<p>ITEM 2</p>  <p>X2</p>	<p>ITEM 3</p>  <p>X3</p>
<p>ITEM 4</p>  <p>X2</p>	<p>ITEM 5</p>  <p>X8</p>	<p>ITEM 6</p>  <p>X2</p>

TOOLS

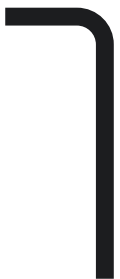

ASSEMBLY INSTRUCTIONS

1. Attach the base plate (3) to the bottom of the stand (4). Once complete secure the base plate using two Allen screws (5) and tighten with the Allen key.

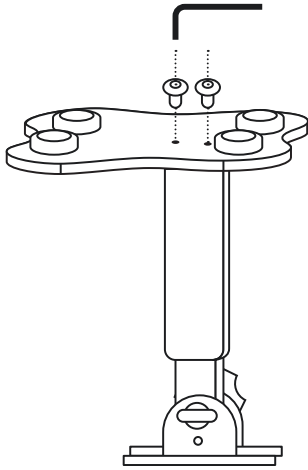

3. Attach the top speaker plate (2) to top of the stand (3). Secure the plate with two Allen screws (5), using the Allen key to tighten them.

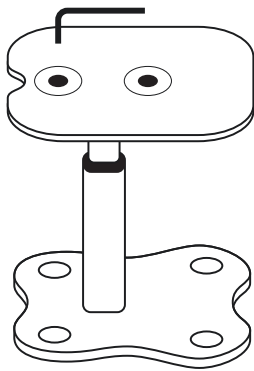

4. Put the rubber cap (1) on the top speaker plate (2) and attach the cable clip (6).

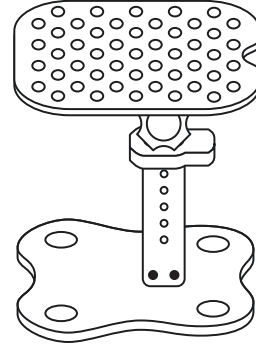

5. Finally, feed the speaker cable through the cable clip (6).

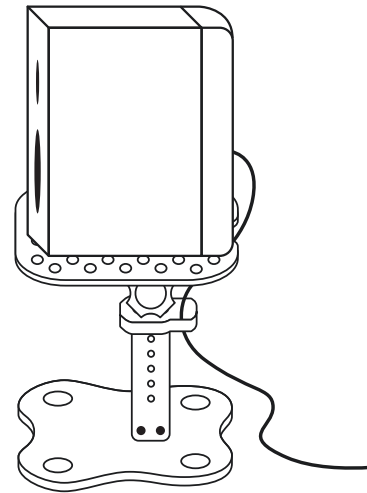

SETTING UP

To select one of the stand's four height options, press the safety pin and slide the stand to your desired height. Make sure the safety pin clicks back into place.

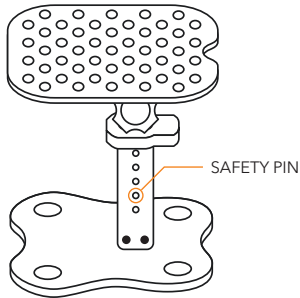

Loosen the knob and adjust to the desired angle. The scale displays what angle the stand is sitting at. The friction of the rubber pad will keep the monitor in place.

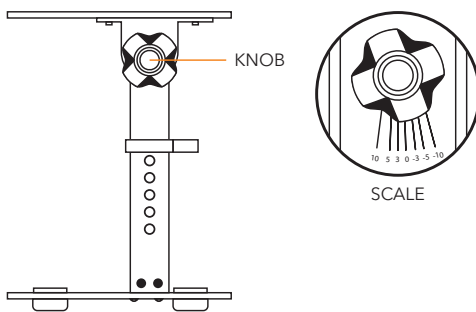

We recommend you position your studio monitors so they are at ear level. They should be set up in an equilateral triangle shape between the listener and the speakers.

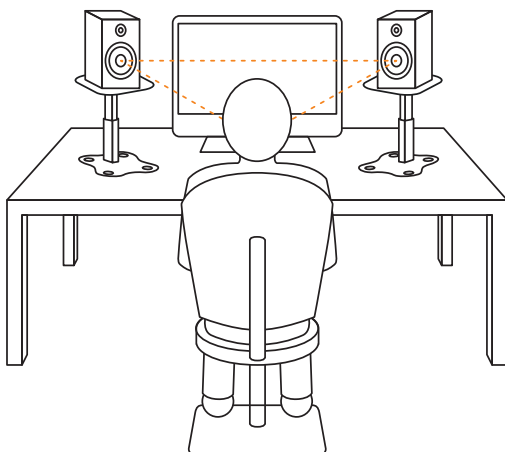

SPECIFICATIONS

Height Adjustment

Range 235mm - 280mm

Top Speaker

Plate Size 220mm x 180mm

Base Plate Size 175mm x 200mm

Maximum Load 100kg (Per stand)

Tilt Angle $\pm 10^\circ$

KETTLESTRING LANE | YORK | YO30 4XF | UNITED KINGDOM
METALLVÄGEN 45A | 195 72 ROSERSBERG | STOCKHOLM | SVERIGE
LAHNSTRASSE 27 | 45478 MÜLHEIM AN DER RUHR | DEUTSCHLAND

If you have any more questions about this product, please do not hesitate to contact the Gear4music Customer Service Team on: **+44 (0) 330 365 4444** or **info@gear4music.com**