

JDV[™] Mk5

Active Direct Box



User Guide

Radial® JDV™ Mk5

Active Direct Box

Table of Contents	Page
Feature set	1-2
Overview.....	3
Pickup or instrument source options	4
Making connections.....	5-6
Selecting channels	7
Using the JDV.....	8
Blending the two channels.....	9
Setting the output controls.....	10
Rackmounting kit.....	11
Specifications	11
Block diagram.....	12
Warranty.....	Back Cover

Thank you for purchasing the Radial JDV Mk5 Super DI. We are confident that you will find it to be one of the most enjoyable pieces of equipment you will ever use and it will likely become a mainstay for all of your recordings and live gigs.

This next generation JDV retains the natural tone of the original while adding many new features that will enhance the performance and open up creative new options. Before you get started please take a few minutes to read through this manual. Inside you will discover why certain features have been implemented which in turn will make using the JDV a lot more fun.

If after you have read the manual, you find yourself asking questions... please visit the FAQ page on the JDV web site. This is where we post questions from users and the latest updates. If you do not find what you are looking for, please send an email to info@radialeng.com and we will do our very best to reply to you in short order.

Now get ready to experience natural sound like never before!

FRONT PANEL FEATURE SET

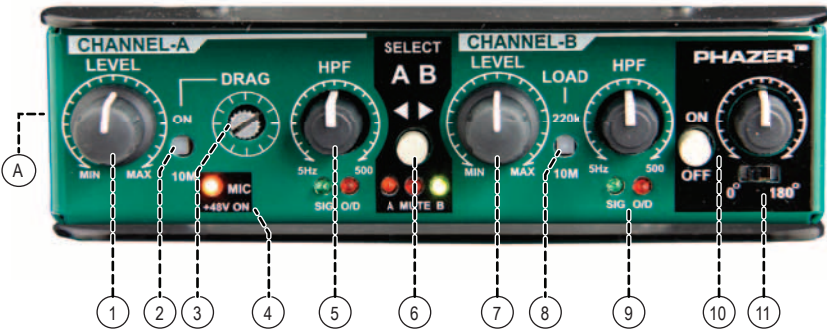

1. **LEVEL A:** Fully variable control, used to set the input sensitivity for channel-A.
2. **ON/10M:** Sets the load to 10MΩ for piezo or variable drag for magnetic pickups.
3. **DRAG:** Used to retain the natural feel of the instrument by adjusting the load for passive pickups.
4. **48V:** LED Indicator lets you know 48V phantom power is activated on the MIC IN.
5. **HPF:** Variable high-pass filter rolls off low frequency resonance that can cause feedback or muddy up the sound.
6. **AB:** Channel selector toggles between A and B inputs with LED status indicators.
7. **LEVEL B:** Fully variable control, used to set the input sensitivity for channel-B.
8. **LOAD:** Switches the input impedance from 10MΩ for piezo transducers to 220kΩ for magnetic pickups.
9. **SIG/OVD:** LEDs show signal presence and if you are exceeding the maximum input level.
10. **PHAZER:** Adjusts the relative phase between channel A and B to time align fundamentals for a more natural sound.
11. **0/180°:** Shifts the Phazer's range from 1°~180° to 181°~360°.

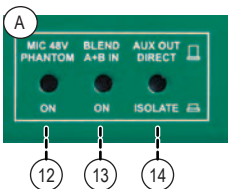

12. **MIC 48V:** Turns on the 48V phantom power at the MIC IN.
13. **BLEND:** Combines input-A with input-B and lets you mix the two sources using the front panel level controls.
14. **AUX OUT/DIRECT:** Lets you introduce an isolation transformer into the stage amp output signal path to reduce hum and buzz caused by ground loops.

REAR PANEL FEATURE SET

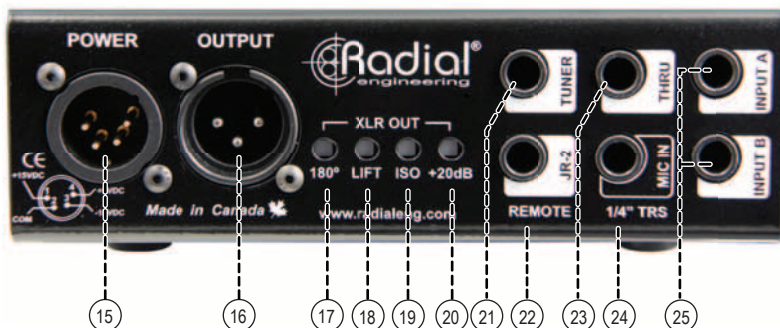

15. **POWER:** Locking 4-pin XLR connection for the external power supply.
16. **OUTPUT:** Balanced XLR output connects to the PA or recording system. Transformer isolated to eliminate hum & buzz caused by ground loops.
17. **180° POLARITY:** Inverts the signal polarity by flipping pins-2 and pin-3 on the XLR output. Used to reduce resonant peaks that cause feedback.
18. **GROUND LIFT:** Disconnects pin-1 at the XLR out to reduce hum and buzz caused by ground loops.
19. **ISO:** Introduces an isolation transformer into the XLR signal path to help eliminate hum and buzz caused by ground loops.
20. **+20dB:** Increased output to line level for direct recording.
21. **TUNER OUT:** Always-on, hi-Z output used to connect an electronic tuner.
22. **JR•2:** For optional JR•2 remote footswitch. When connected, this lets you select the input channel or mute the JDV for silent tuning.
23. **THRU:** Unbalanced 1/4" thru-put used to feed the stage amp.
24. **MIC IN:** Balanced 1/4" TRS input for condenser or dynamic microphone.
25. **INPUTS A & B:** Unbalanced 1/4" input jacks used to connect instruments to the JDV.

OVERVIEW

The Radial JDV is more than a direct box. It is a dual input DI box, mic preamp, two-channel mixer and phase adjustment tool all in one. This means it can be used for all types of instruments including:

- Passive electric bass with magnetic pickup
- Active electric bass with built-in preamp
- Acoustic guitar with built-in preamp
- Piezo equipped upright bass
- As a microphone preamp for an instrument mounted mic
- For direct recording or live performance
- Any combination thereof

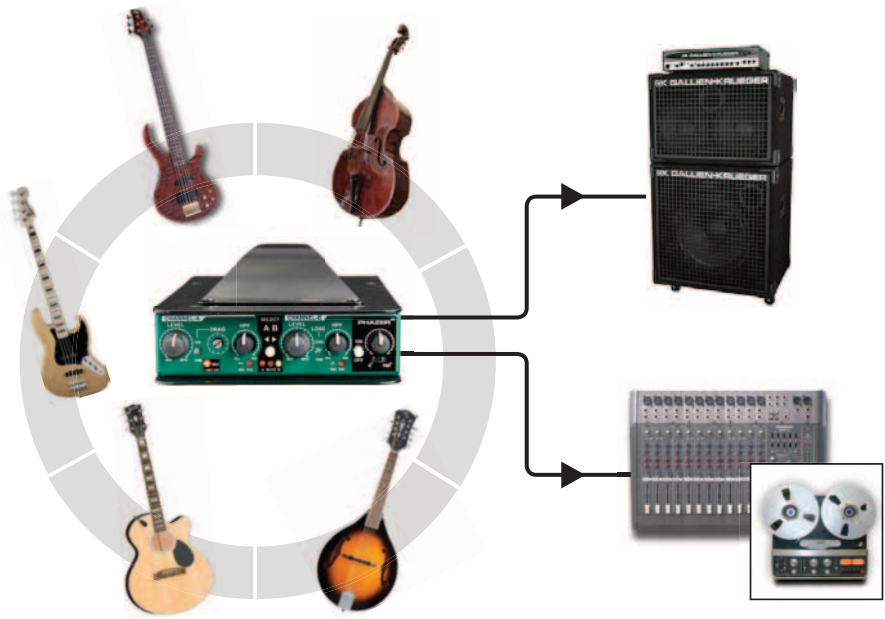

What is particularly cool about the JDV is that it packs all of this in a relatively small box. This means that you have to start by understanding the many features and then apply them according to how you intend to use it.

There are two inputs and one output. You can set each input to suit a particular instrument and then send the unbalanced output to a stage amp, while sending the balanced signal to a recording workstation or PA system. You can switch between the inputs using the front panel switch or via an optional remote footswitch. You also have the option of blending both channels together so that they play simultaneously.

PICKUP OR INSTRUMENT SOURCE OPTIONS

If you review all of the various instrument pickups or music sources that are in use today, one can actually break them down to five major categories. The JDV is designed to accommodate all of them.

Magnetic pickup

This is the most common type of pickup found on a Gibson® Les Paul electric guitar or Fender® Jazz bass. To accommodate them, the JDV is equipped with Drag™ control load correction. This lets you adjust the load from 1MΩ down to 10kΩ to set the tone as if connected directly to a tube amplifier. Set the Drag control to 12 o'clock and then adjust to suit.



Buffered instrument

A buffer is basically a unity gain amplifier. An active bass or acoustic guitar with built in electronics can be grouped into a category called a buffered source. These – usually battery operated devices – produce a louder signal than a passive magnetic pickup. Since they are already amplified, changing the load using the Drag control will have very little effect. However, you can reduce the susceptibility by lowering the input impedance by rotating the Drag control fully counter-clockwise.



Piezo transducer

For years artists and engineers have complained that piezo pickups tend to sound harsh and peaky. During the development of the Radial Tonebone PZ-Pre™, we discovered that by elevating the impedance, you can dramatically widen the frequency response and smooth out the tone. Like the PZ-Pre, the JDV sports a 10MΩ option for piezos that extends the response so well we actually had to incorporate high-pass filters to control the excessive bottom end! The filter is particularly effective at 'sizing' the instrument so that when you connect an acoustic guitar or a mandolin, you can set the filter so that it coincides with the instrument in use.



Line level instrument

Although connecting a high output keyboard or drum machine to the JDV is somewhat over the top, it will occasionally occur. This is where the internal rail voltage will come in handy. Unlike most direct boxes that have a rail voltage of about 3 to 5 volts, the JDV is able to handle signal levels in excess of 16 volts!

Microphone

Many acoustic musicians use a clip-on microphone to capture nuances that may be lost when using a magnetic pickup. The JDV is equipped with a balanced input that may be used with a dynamic or a condenser mic by activating the 48V phantom power. As a safety measure, the 48V phantom power must be turned on each time the JDV is being used.

As you gain familiarity with the JDV, you will discover that the channel-A feature set is slightly different than channel-B so you can use any of the above, in whatever combination works best for you.

MAKING CONNECTIONS



Before making connections always ensure levels are turned down or audio systems turned off. This will avoid connection or turn-on transients that could harm sensitive components such as the tweeters in your speaker system. There is no power switch on the JDV. As soon as you plug in the power supply the JDV will come to life. The JDV's external power supply will accommodate any voltage from 100V to 240V. Simply change the IEC cable to suit. The 4-pin XLR provides a secure locking connection. Before disconnecting, once again make sure the equipment that is connected is powered off or levels turned down.

As there are many connection options, we will use a simple bass guitar as the working example. The same basic approach will work for most instruments. Begin by setting all of the controls and switches in the start position as shown below.

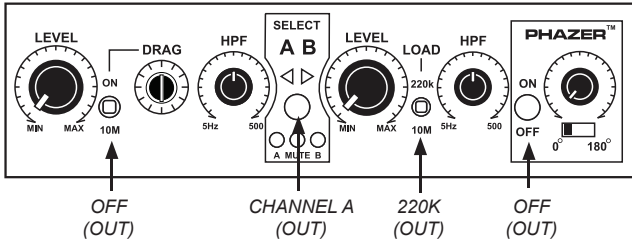

Connect your instrument to input-A using a standard 1/4" coaxial guitar cable and the XLR output to a mic input on your mixing console. The balanced XLR male output employs the AES standard with pin-1 ground, pin-2 hot (+) and pin-3 cold (-). Check to make sure the AB selector is set to A (in the "out" position). Set the level control on the JDV to 12 o'clock and increase the mixer volume until you reach a comfortable listening level. Always test at low volumes to prevent damage to components should a connection be loose. If you like, connect your stage amp using the THRU output. This buffered output is used to send the active signal to the stage amp or effects pedals.



Using piezo transducers

In order to provide maximum flexibility, both channels A and B are equipped with 10MΩ inputs for piezos. This enables two piezos to be used at once, a magnetic pickup with a piezo, a mic with a piezo or any combination of the above. The benefit here is that you do not have to use a secondary piezo preamp, simply connect directly to the JDV and it will work great.

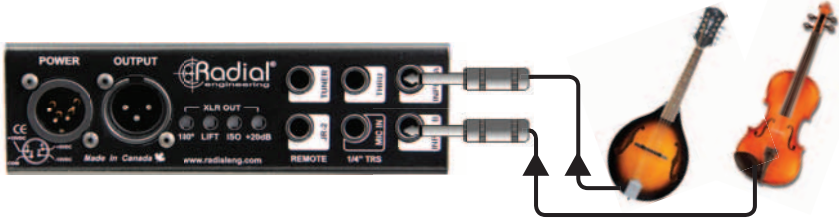

Using a microphone with the JDV

Channel-1 on the JDV is equipped with a dedicated 1/4" TRS balance mic input. Due to limited space, this is unfortunately not a standard XLR. The good news is that music stores carry XLR-F to 1/4" TRS cables as a standard offering. Once connected, this switching jack will automatically turn off the guitar inputs.

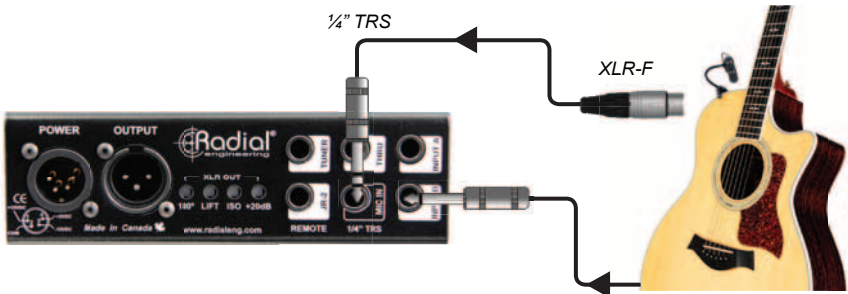

Since most instrument-mounted microphones are condensers, they generally require 48-volt phantom power. The JDV is equipped with 48V phantom on channel-A. To turn on the phantom power, simply depress the side access set & forget switch.

Caution! If you mistakenly connect your pickup to the mic input when phantom power is activated, it can seriously damage your pickup. For this reason, the JDV is equipped with a preventative measure that requires turning on the phantom power each time you power-on the JDV. To avoid a loud pop always turn PA/amp levels off before turning on phantom power.



SELECTING CHANNELS

Using the AB select switch

You can now connect your second bass to input-B. To switch, simply depress the front panel SELECT switch. You can also toggle the input by using the optional JR•2 footswitch. When connected, the JR•2 derives its power from the JDV to illuminate the status LEDs. When depressed, both the LEDs on the JR•2 and on the JDV front panel will follow suit. Set the Channel-B level control to 12 o'clock and then switch back and forth between the two instruments and adjust the levels so that they are relatively even in loudness.

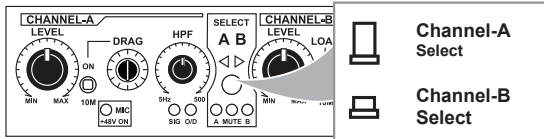

JR•2 remote footswitch

For quiet tuning on stage you can mute the JDV output using the optional JR•2 footswitch. Two footswitches are on board to allow AB switching and mute. When muted, the front panel MUTE LED will illuminate as will the footswitch mute LED. When muted, all of the JDV outputs other than the tuner will be turned off. The JR•2 may be connected using either a TRS-TRS or TRS-XLR cable.

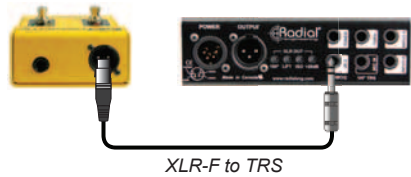
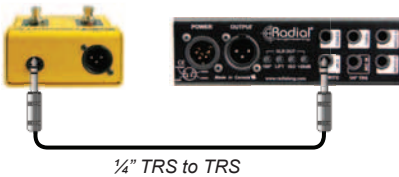

Connect an electronic tuner

The JDV is equipped with a dedicated 1/4" tuner output that is always on. This is separately buffered so that the internal quartz clock will not introduce noise into the JDV or the audio system. This output can also be used to feed a second amp.

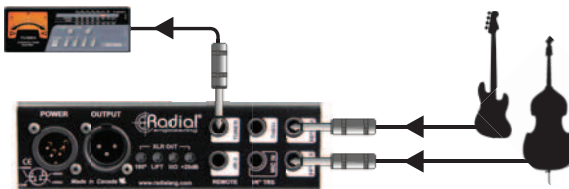

USING THE JDV

Adjusting the DRAG Control

When you connect your bass to the JDV the signal will be buffered by a unity gain amplifier. This can brighten your tone and enable much longer cables (upwards to 15 meters or 50') to be used without noise. Drag™ is a load correction circuit that enables the user to replicate the tone and feel as if connected directly to your amp using a regular 15' guitar cable.

To activate the DRAG control, push the set & forget switch inward. Start by setting the Drag control to 12 o'clock and rotate it clockwise. You will note the tone will become brighter. Now try turning it counter-clockwise to darken the tone. Adjust to suit. Drag control has little effect on an active bass or acoustic guitar with built-in electronics as the signal is pre-buffered by the electronics inside the instrument.



When set in the outward position, the DRAG control is turned off and the input impedance rises to 10MΩ to suit piezo transducers.

Using the high-pass filter

One of the most practical functions on the JDV is the high-pass filter (HPF). This fully variable control lets you adjust the cut-off point or low frequency limit to eliminate resonance. What few realize is that by reducing excessive low frequencies, instruments will fit more naturally into the mix, enabling their levels to be louder without competing as much for bandwidth. This 'Nashville trick' has been used for years to combine various acoustic instruments such as upright bass, acoustic guitar, banjo, fiddle and mandolin by sizing the instrument to suit.



Start by rotating the filter clockwise until the low frequency cut-off becomes audible. Then back off the control slightly. This will not only clean up your mix, but also help eliminate weird modulations that can creep into recordings.

When using two sources simultaneously, listen to each one individually as you adjust the low frequency cut-off point and then remix the two channels (sources) to suit.



BLENDING THE TWO CHANNELS

The JDV is also equipped with a BLEND function on the side panel that allows both channels to be active at the same time. This can be used to combine a piezo and a magnetic pickup on an acoustic guitar, a mic and a piezo on a bass or to simply have two instruments on all the time for practicality sake. The BLEND is activated by depressing the set & forget switch inward. You may find a slight drop in volume due to the mixing process. Simply adjust the input level controls to compensate.

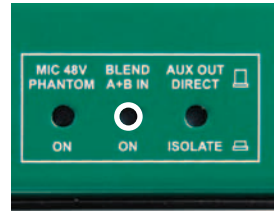

Using the Phazer

Combining two pickups or a mic with a pickup can often produce much more realistic sounds than using a mic or pickup alone. Things really start to shine when you combine the two sources using the BLEND function and then introduce the PHAZER™ into the equation.

The Phazer is an analogue phase adjustment tool that is applied to the primary source or that closest to the originating sound. This is then 'fractionally delayed' to time-align the fundamental frequencies so that they play in phase.



A - Condensator Mic



B - Pick up

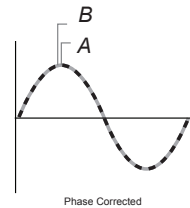
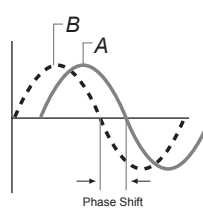

Start by setting up two sources on a single instrument and set the relative volumes to the same level. Keep in mind that if you use a mic, any movement or altering the distance of the mic from the sound hole will change the relative phase and loudness. So you either have to carefully remain in one place relative to the mic or use an instrument-mounted microphone that will move with the instrument.

Set the phase control fully counter-clockwise. Activate the Phazer by pushing in the switch. Now have someone rotate the control as you play. Altering the relative level between the mic and pickup dramatically alter the tone of the instrument. Try changing the range using the slider switch. Have fun. Note that there is no perfect setup. Phase is relative and cannot be anticipated. Simply use your ears to find the most pleasing sound.

SETTING THE OUTPUT CONTROLS

Using the 180° polarity reverse

The JDV is equipped with a 180° polarity reverse that toggles pin-2 and pin-3 on the XLR output. This function was originally intended to connect older vintage equipment that did not employ the AES standard with new gear.

This handy switch can also perform other various functions. When used with an electric bass in a small venue, reversing the polarity can be used to better align low frequencies from the on-stage bass amp with the PA system. When used with an acoustic instrument, it can be used to alleviate feedback without reverting to dramatic EQ curves. When sound from the PA system, the on-stage amp, monitors and the venue itself combine, huge frequency bumps that can cause resonant feedback or phase cancellation will often occur. Reversing the polarity on the JDV can often move the problem out of the way.



Lifting the ground and isolating the output

If you encounter hum or buzz, you can lift the ground on the XLR output by depressing the ground lift switch. This is recessed in order to prevent accidental use when reaching in behind the JDV. Use a small screwdriver to depress the switch.

You can also address noise problems by introducing an isolation transformer to the signal path. The XLR output can be isolated via the rear panel switch, and the AUX output via the side panel switch. It is good practice to employ a power bar to connect all of your amps, effects and the JDV so that they share the same electrical ground.

Try isolating the XLR first, as this will disconnect the audio ground between the stage and the PA or recording system. If you still hear hum, try reconnecting the XLR ground and then isolating the AUX output. Ground problems can crop up for all kinds of reasons. Simply take your time to try the various combinations until the noise goes away.

+20dB for direct recording

When recording direct, some players prefer to take the sound right off the JDV instead of going through a mic preamp. Depress the +20dB switch to increase the JDV output from mic level to line level.

RACK MOUNTING THE JDV

For touring the JDV may be mounted into a standard 19" rack using the optional rack mount kit. This three piece kit (*part number: R800 2020 02*) enables one or two JDV to be rack mounted in a 1RU rack space.

Single unit mounting:

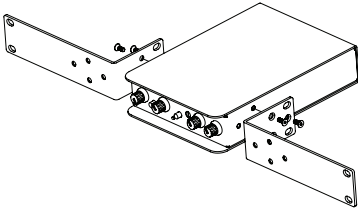

Double unit mounting:

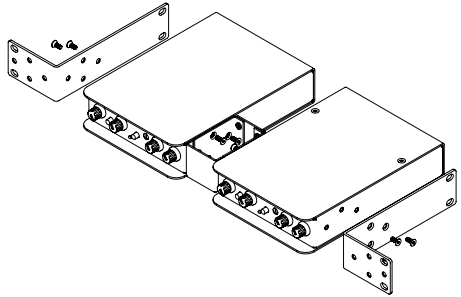

SPECIFICATIONS

Frequency response.....	30Hz ~ 20KHz
Gain (instrument input).....	+25 dB
Gain (line level boost).....	+20 dB
Gain (microphone input).....	+25 dB
Dynamic range	107dB
Equivalent input noise	-90 dBu
Input impedance	22k to 500k Drag on - 1/4" input: 10M Drag off
Output impedance at XLR.....	400 Ohms
Low-cut filter:	Variable from 25Hz ~ 500Hz (-3dB point)
Size (W, D, H) & weight.....	5.75" x 8.25" x 1.75" (2.75" with handle) 146mm x 210mm x 45mm (70mm with handle)
Weight	3.95lbs. (1.80kg)
Power supply.....	+/-16v (1600mA) 5-pin XLR power supply

**Specifications are subject to change without notice.*

BLOCK DIAGRAM

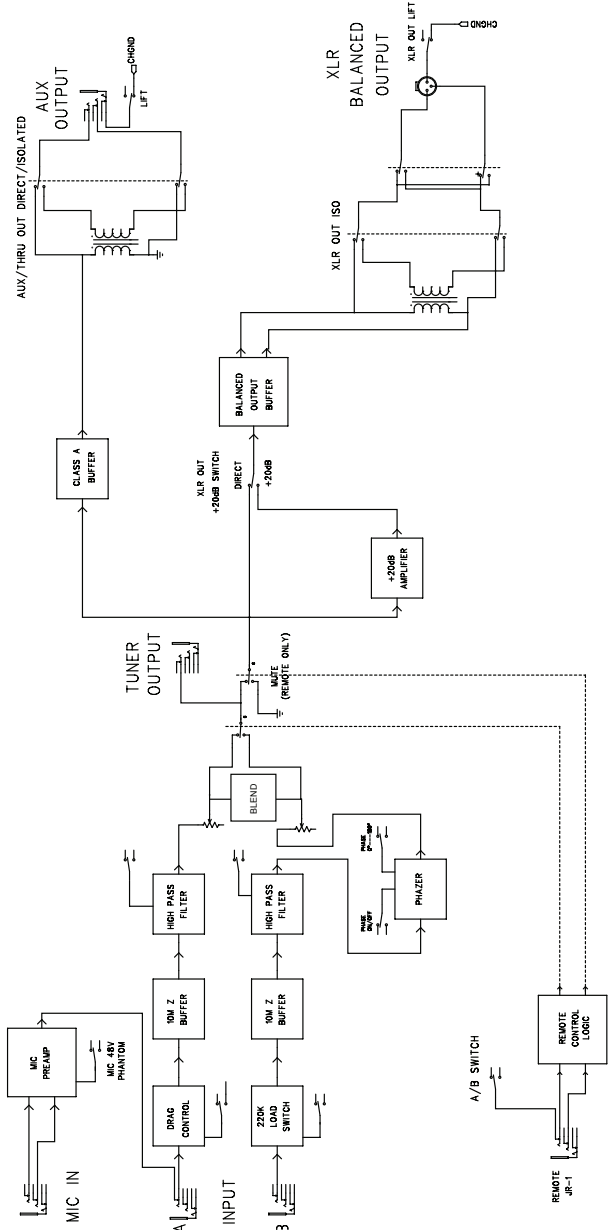

THREE YEAR TRANSFERABLE LIMITED WARRANTY

RADIAL ENGINEERING LTD. ("Radial") warrants this product to be free from defects in material and workmanship and will remedy any such defects free of charge according to the terms of this warranty. Radial will repair or replace (at its option) any defective component(s) of this product (excluding finish and wear and tear on components under normal use) for a period of three (3) years from the original date of purchase. In the event that a particular product is no longer available, Radial reserves the right to replace the product with a similar product of equal or greater value. In the unlikely event that a defect is uncovered, please call 604-942-1001 or email service@radialeng.com to obtain an RA number (Return Authorization number) before the 3 year warranty period expires. The product must be returned prepaid in the original shipping container (or equivalent) to Radial or to an authorized Radial repair center and you must assume the risk of loss or damage. A copy of the original invoice showing date of purchase and the dealer name must accompany any request for work to be performed under this limited and transferable warranty. This warranty shall not apply if the product has been damaged due to abuse, misuse, misapplication, accident or as a result of service or modification by any other than an authorized Radial repair center.

THERE ARE NO EXPRESSED WARRANTIES OTHER THAN THOSE ON THE FACE HEREOF AND DESCRIBED ABOVE. NO WARRANTIES WHETHER EXPRESSED OR IMPLIED, INCLUDING BUT NOT LIMITED TO, ANY IMPLIED WARRANTIES OF MERCHANTABILITY OR FITNESS FOR A PARTICULAR PURPOSE SHALL EXTEND BEYOND THE RESPECTIVE WARRANTY PERIOD DESCRIBED ABOVE OF THREE YEARS. RADIAL SHALL NOT BE RESPONSIBLE OR LIABLE FOR ANY SPECIAL, INCIDENTAL OR CONSEQUENTIAL DAMAGES OR LOSS ARISING FROM THE USE OF THIS PRODUCT. THIS WARRANTY GIVES YOU SPECIFIC LEGAL RIGHTS, AND YOU MAY ALSO HAVE OTHER RIGHTS, WHICH MAY VARY DEPENDING ON WHERE YOU LIVE AND WHERE THE PRODUCT WAS PURCHASED.



www.radialeng.com

Radial Engineering Ltd.

1588 Kebet Way, Port Coquitlam BC V3C 5M5

tel: 604-942-1001 • fax: 604-942-1010

info@radialeng.com • www.radialeng.com

