

The Tensor performs realtime tape stop, slowdown, reverse, time stretching, and pitch shifting. Three hold modes allow you to loop, overdub, and mangle up to 4.8 seconds of sound with pitch shifting, stretching, time compression, and random slicing.

The Tensor is always listening, and can switch from bypass to effect with no gap or delay. Latching and momentary modes allow you to inject controlled pitch jumps, stutters, and instant backwards solos.

Intelligent randomization adapts to the current knob settings to add random glitches, stutters, and pitch shifts.

To get started, set the controls to "Normal" (Sample Settings) and play a loop or some music through the Tensor. Try the SPEED, TIME, and PITCH knobs one at a time, then combine them. Next, slowly turn up the RAND knob and hear how it interacts with the other controls.

## TENSOR

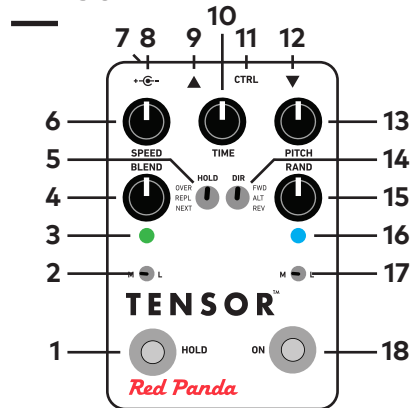

- |                  |                     |
|------------------|---------------------|
| 1 Hold switch    | 10 Time stretch     |
| 2 Momentary hold | 11 Expression pedal |
| 3 Hold indicator | 12 Input            |
| 4 Wet/dry blend  | 13 Pitch shift      |
| 5 Hold mode      | 14 Loop direction   |
| 6 Tape speed     | 15 Randomization    |
| 7 USB MIDI       | 16 Bypass indicator |
| 8 9V DC 250 mA   | 17 Momentary effect |
| 9 Output         | 18 Bypass switch    |

## CONTROLS

### SPEED

Realtime tape slowdown, stop, and reverse effect.

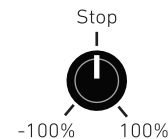

### TIME

Time stretch & compression without pitch shift. Time compression only available in hold mode.

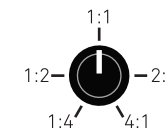

### PITCH

±2 octave pitch shift. Playback speed changes in hold mode.



### BLEND

Wet/dry mix.

### RAND

Randomization amount. Reacts to other knob positions.

### ON

Bypass switch. **M/L** switch selects momentary or latching operation.

Bypass indicator shows time stretch:

- Time stretching
- Normal
- Time compression

## HOLD

### HOLD

- OVR** Overdub (sound on sound)
- REC** Record (replace loop)
- NXT** Next (dual buffer)

### DIR

- FWD** Loop plays forward
- ALT** Loop alternates forward/reverse
- REV** Loop plays in reverse

### M/L (Momentary/Latching)

- M** Hold to start recording, release to switch to play back.
- L** Tap once to start recording, tap again to switch to play back.
- ON** Stop loop playback.

- Record/overdub/set NXT length
- Play loop



## SAMPLE SETTINGS

---

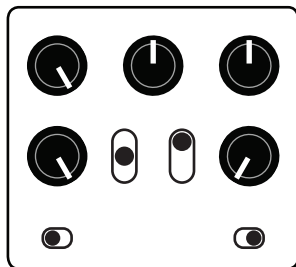

Normal

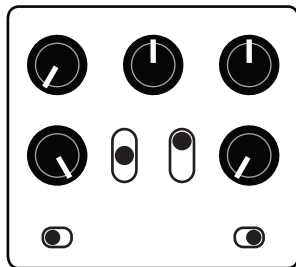

Tape Reverse

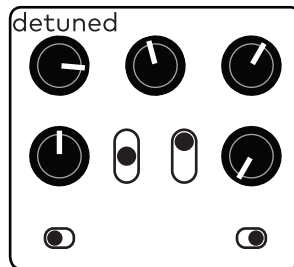

Doubling

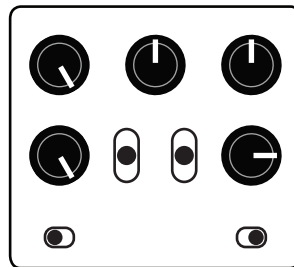

Glitch

## WARRANTY

---

This product is warranted against defects in materials and workmanship for one (1) year from date of original purchase. It does not cover damages or wear resulting from accident, misuse, abuse, or unauthorized adjustment and/or repair. Should this product require service (or replacement at our option) while under warranty, please contact [support@redpandalab.com](mailto:support@redpandalab.com).

## SPECS

---

**Input impedance:** 1 M $\Omega$   
**Output impedance:** < 470  $\Omega$   
**Maximum input:** +5.5 dBu (default), +7 dBu max  
**Bypass:** analog buffered  
**Power:** 9V DC, center negative  
**Current:** 250 mA

## CTRL (EXPRESSION PEDAL)

---

By default, the expression pedal will morph from normal playback (heel down) to the knob settings (toe down).

Use an expression pedal with a 10-25 k $\Omega$  linear pot. The CTRL input also supports control voltages with a range of 0 to +3.3V.



**QUICKSTART**  
TENSOR

 Red Panda