

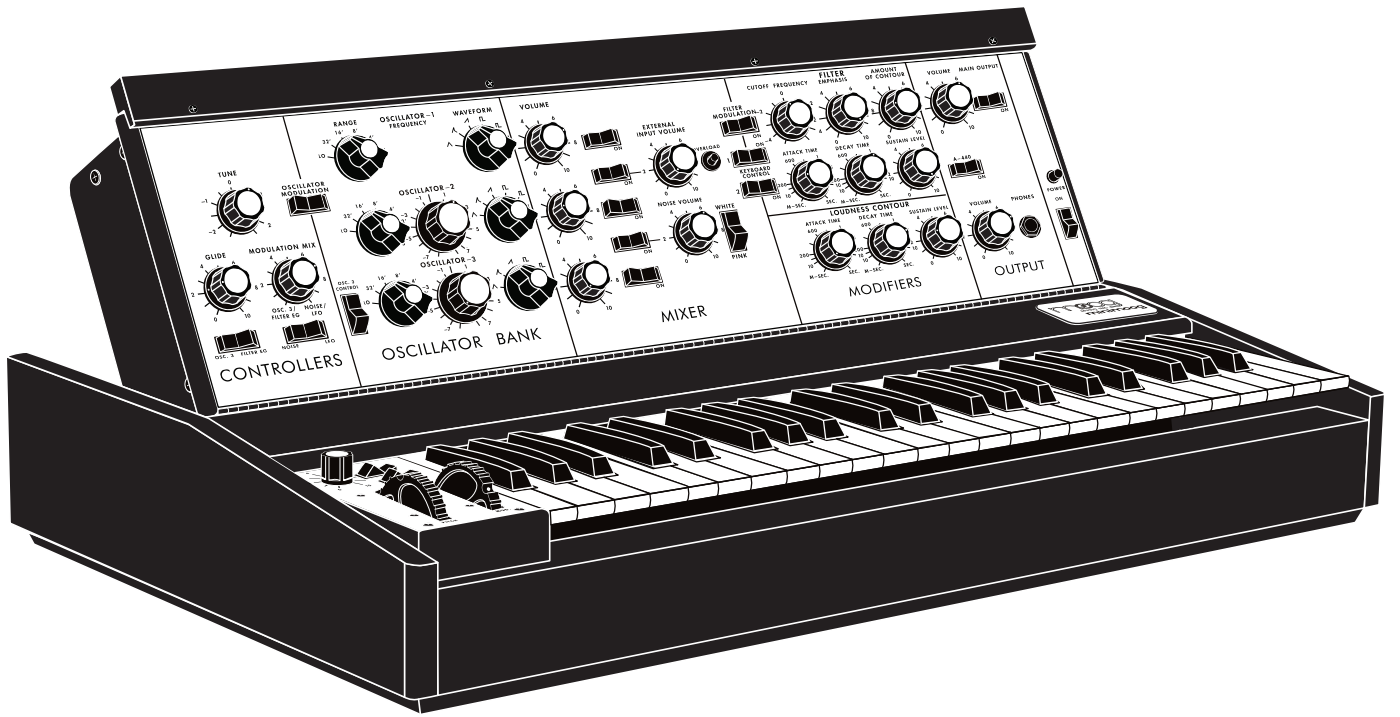

MINIMOOG[®] MODEL D

USER'S MANUAL & PATCH SHEETS

USER'S MANUAL



“All the sounds you’ve ever heard are like a second. The Moog is an eternity. Seclude yourself now and let the music sweep you away and into the dawn. Seek to become newly aware of yourself, the world of nature around you, the people near you. And if you feel it, express yourself.”

- David Van Koevering, 1971 -

IMPORTANT SAFETY INSTRUCTIONS

WARNING - WHEN USING ELECTRIC PRODUCTS, THESE BASIC PRECAUTIONS SHOULD ALWAYS BE FOLLOWED.

1. Read all the instructions before using the product.
2. Do not use this product near water - for example, near a bathtub, washbowl, kitchen sink, in a wet basement, or near a swimming pool or the like.
3. This product, in combination with an amplifier and headphones or speakers, may be capable of producing sound levels that could cause permanent hearing loss. Do not operate for a long period of time at a high volume level or at a level that is uncomfortable.
4. The product should be located so that its location does not interfere with its proper ventilation.
5. The product should be located away from heat sources such as radiators, heat registers, or other products that produce heat. No naked flame sources (such as candles, lighters, etc.) should be placed near this product. Do not operate in direct sunlight.
6. The product should be connected to a power supply only of the type described in the operating instructions or as marked on the product.
7. The power supply cord of the product should be unplugged from the outlet when left unused for a long period of time or during lightning storms.
8. Care should be taken so that objects do not fall and liquids are not spilled into the enclosure through openings.

There are no user serviceable parts inside. Refer all servicing to qualified personnel only.

NOTE: This equipment has been tested and found to comply with the limits for a class B digital device, pursuant to part 15 of the FCC rules. These limits are designed to provide reasonable protection against harmful interference in a residential installation. This equipment generates, uses and can radiate radio frequency energy and, if not installed and used in accordance with the instructions, may cause harmful interference to radio communications. However, there is no guarantee that interference will not occur in a particular installation. If this equipment does cause harmful interference to radio or television reception, which can be determined by turning the equipment off and on, the user is encouraged to try to correct the interference by one or more of the following measures:

- Reorient or relocate the receiving antenna.
- Increase the separation between the equipment and receiver.
- Connect the equipment to an outlet on a circuit different from that to which the receiver is connected.
- Consult the dealer or an experienced radio/TV technician for help.

CAUTION: Please note that any changes or modifications made to this product not expressly approved by Moog Music Inc. could void the user's authority granted by the FCC to operate the equipment.

TABLE OF CONTENTS

- 06 INTRODUCTION**
 - A Brief History
 - New Features Overview
- 07 GETTING STARTED**
 - Contents
 - Setup & Connections
- 08 Audio Monitoring**
- 09 CREATING SOUND**
- 10 FEATURES & CONTROLS**
 - Overview
 - 11 Oscillator Bank**
 - 12 Controllers**
 - 13 Left-Hand Keyboard Panel**
 - 14 Mixer & Noise**
 - 15 Modifiers**
 - 17 Output**
 - Keyboard
 - 18 Top Patch Panel**
- 20 PERFORMANCE TIPS & TECHNIQUES**
 - Processing External Audio
- 21 Enhancing a Keyboard Performance**
 - Creating FM Effects
 - Creative Switching
- 22 GLOBAL SETTINGS**
 - Power-On Commands
- 25 OSCILLATOR TUNING PROCEDURE**
- 27 SPECIFICATIONS**
- 30 WARRANTY**

INTRODUCTION

A BRIEF HISTORY

Created in 1970, the Minimoog Model D is the instrument that brought the synthesizer out of the university laboratories and recording studios and placed it in the hands of on-stage musicians around the world. Unlike the larger modular synthesizers of the day, the Minimoog Model D could be played instantly, with no cable-patching between modules. Everything the performer needed was right there on the panel. In fact, the true genius of the Minimoog Model D was the front panel design. By grouping together related components—Controllers, Oscillators, Modifiers, etc.—the front panel became a flowchart that made audio synthesis simple to understand. The Minimoog Model D was quickly embraced by a diverse roster of performers touching nearly every genre of music. In just over a decade, well over 10,000 Minimoog Model D synthesizers were sold worldwide. Today, the Minimoog Model D remains one of the most coveted of all synthesizers.

NEW FEATURES OVERVIEW

Each of these features are discussed in depth at the appropriate place in the manual.

KEYBOARD

A Fatar TP-9 keyboard has been implemented with the ability to transmit both After-Pressure and Velocity control voltages. While these signals are not hard wired to any specific parameter, the expanded Top Patch Panel allows Velocity and After Pressure signals to modify the Filter Cutoff Frequency, Loudness and Oscillator Pitch.

DEDICATED LFO (LOW FREQUENCY OSCILLATOR)

Traditionally, **OSCILLATOR-3** could operate independently of the keyboard and be used as an LFO. Now, a dedicated LFO has been added to the Left-Hand Keyboard panel. In addition, Filter Contour (**FILTER EG**) is now also available as a modulation source.

EXPANDED PATCH BAY

CONTROL OUTPUTS

- V-TRIGGER/GATE
- PITCH
- VELOCITY
- AFTER-PRESSURE

CONTROL INPUTS

- V-TRIGGER/GATE
- OSCILLATOR
- FILTER
- LOUDNESS
- EXTERNAL MODULATION SOURCE

POWER-ON COMMANDS

By holding down specific keys as the Minimoog Model D is turned on, you can select a MIDI Channel, transpose the instrument, choose the note priority, and set other global functions.

MIDI

Five-pin DIN MIDI In, MIDI Out, and MIDI Thru jacks have been added to provide basic MIDI connectivity.

EXTERNAL POWER SUPPLY

The Minimoog Model D now features a universal (100-240 VAC; 50/60 Hz) external power supply, reducing the weight and heat created by the internal power supply, and improving stability of the instrument. This also makes it easier to travel with your Minimoog Model D.

GETTING STARTED

Begin by carefully removing your new Minimoog Model D from its packaging. Moog recommends that you save all original packing material, should you ever need to safely move or ship the instrument.

CONTENTS

In addition to the instrument itself, the Minimoog Model D also includes:

1. This owner's manual
2. Power adapter and connecting power cord
3. Registration card

SETUP & CONNECTIONS

The front panel of the Minimoog Model D is hinged, so use caution and avoid grasping the top of the panel when lifting or moving the instrument.

Place the Minimoog Model D on a stable surface such as a table or keyboard stand. Be sure the instrument is placed at a comfortable playing height. The front panel can remain flat, or it can be tilted to a convenient angle for viewing and accessing the controls.

To get started, you will need to supply the Minimoog Model D with power and connect it to an audio monitoring system, or listen using a set of headphones.

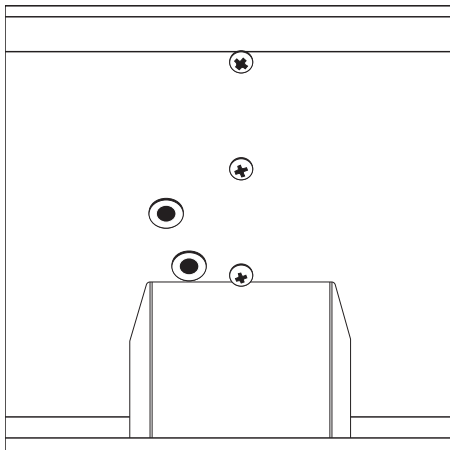

RAISING THE PANEL

1. Grab the front panel by the top wood edge and tilt it forward towards the keyboard.
2. Flip up the hinged metal kickstand located in the area under the rear panel.
3. Position the top edge of this kickstand against one of the four screw heads protruding slightly from the rear of the panel. (Each screw head will support the panel at a different angle.)
4. To lower the panel, again tilt the panel forward until the hinged kickstand returns to its original position, then gently lower the panel.

AC POWER

The Minimoog Model D uses a universal power supply that can operate using AC power sources ranging from 100 to 240 volts at either 50 or 60 cycles (Hz). The included power supply features a detachable IEC-style power cable.

1. Connect the included IEC power cable to the Minimoog Model D power supply.
2. Connect the power supply cable to the Minimoog Model D locking XLR-4 connector.
3. Connect the other end of the power cable to a suitable AC wall outlet.
4. Finally, use the **POWER** switch to turn on your new Minimoog Model D.

NOTE: The power supply connects to the Minimoog Model D using a locking connector. To release this connector from the instrument, simply press the locking tab at the base of the connector and gently pull up on the connector plug. Do not pull on the cable itself.

AUDIO MONITORING

Connect the Minimoog Model D to an instrument amplifier, powered speaker, or other monitoring system. On the top panel, two 1/4" TS outputs are provided. One is a high-level output suitable for connection to the line input of a mixer, recording setup, or other audio system. The other is a high impedance, low-level output that can connect to an instrument amplifier or other high gain, high impedance input.

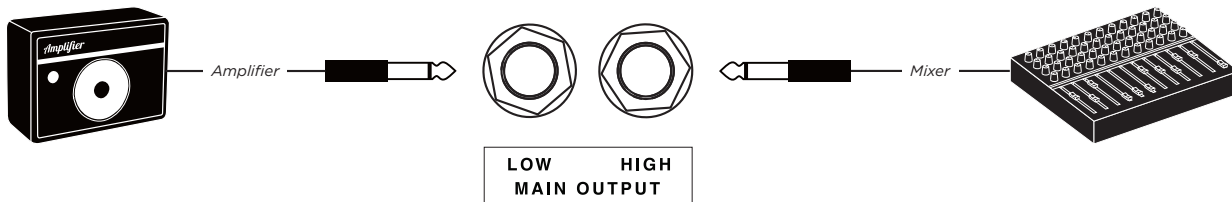

1. Begin with the monitoring system off and the Minimoog Model D **VOLUME** knob set to zero.
2. Use the appropriate output to connect the Minimoog Model D to the audio monitoring system.
3. Turn the Minimoog Model D on.

TIP: To test the audio system and set your levels without taking the time to program a sound, at this stage simply flip On the **A-440** switch in the output section. This will provide a reference tone controlled by the **VOLUME** knob.

4. Turn the **MAIN OUTPUT** switch On and raise the **VOLUME** knob to about 6.
5. Now turn on the monitoring system, and raise the levels to an appropriate audio level.

NOTE: Because the Minimoog Model D is an analog instrument, please allow it to warm up for 10-20 minutes before use. This will best ensure the most stable performance.

HEADPHONE MONITORING

The Minimoog Model D also features a headphone output jack with an independent Volume control. Plug your headphones into the **PHONES** jack and adjust the level using the **PHONES** Volume knob.

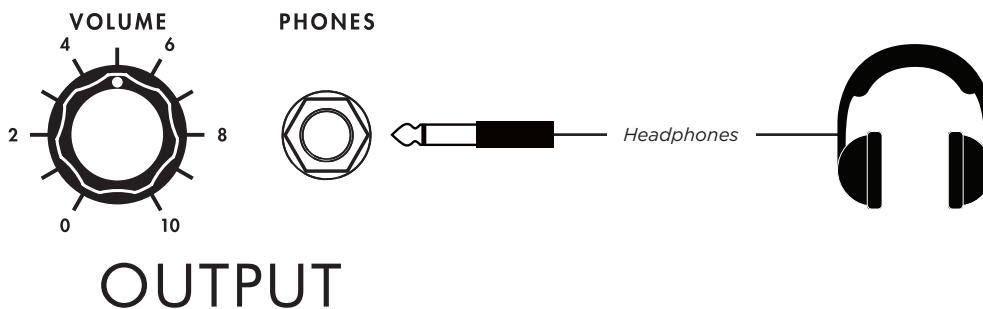

CREATING SOUND

In analog synthesizers, each set of circuits performs a particular job; each oscillator, filter, and contour generator is a self-contained module. The Minimoog Model D connects these modules together internally using both audio signals and control signals. Audio signals are the sounds you hear emanating from the sound creation circuits of the instrument. Control signals modify the settings of these circuits by providing a continuously variable control voltage—the foundation of the voltage controlled synthesizer. An additional type of control signal is known as a Gate or V-Trigger, which is simply used to initiate an event. For example, playing a note on the keyboard sends a control voltage to the Oscillators to change the pitch, and also sends a gate signal to trigger the Loudness Contour and Filter Contour generators. Additional patch points are provided on the Top Patch Panel to expand the functionality of the Minimoog Model D, and to allow it to interface with other voltage-controlled equipment.

SOUND EXPERIMENTS

If you are not familiar with analog subtractive synthesis or with the Minimoog Model D, here are some quick experiments to introduce you to the main sound-creation components and their functions. Begin by setting the Minimoog Model D front panel controls as shown below. Ignore any knobs or switches that have no value indicated in the diagram.

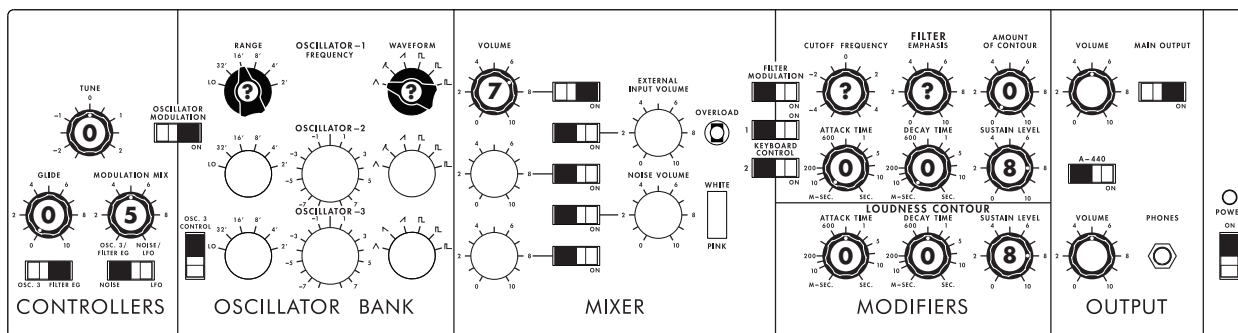

1. These settings isolate **OSCILLATOR-1** and route it through the **FILTER**. You can use the **OSCILLATOR-1/RANGE** knob to select different octave settings, and the **WAVEFORM** knob to listen to the distinct harmonic content of each waveform.
2. In the **FILTER** section, experiment with the **CUTOFF FREQUENCY** and **EMPHASIS** knob settings to see how the **FILTER** affects each of the different Oscillator Waveforms.
3. To make the sound less organ-like, first turn On the **DECAY** switch located above the **PITCH** and **MOD** wheels at the left end of the keyboard. Then play with the position of the **ATTACK TIME** and **DECAY TIME** knobs in the **LOUDNESS CONTOUR**.
4. The **FILTER** has its own **ATTACK TIME** and **DECAY TIME** knobs. As you adjust these values, you will also need to raise the **AMOUNT OF CONTOUR** value to hear the effect. Continue to explore the **FILTER CUTOFF** and **EMPHASIS** knobs as you change these settings.

***NOTE:** Each of the knobs, switches, and other controls are explained in more detail in the following sections of the manual.*

FEATURES & CONTROLS

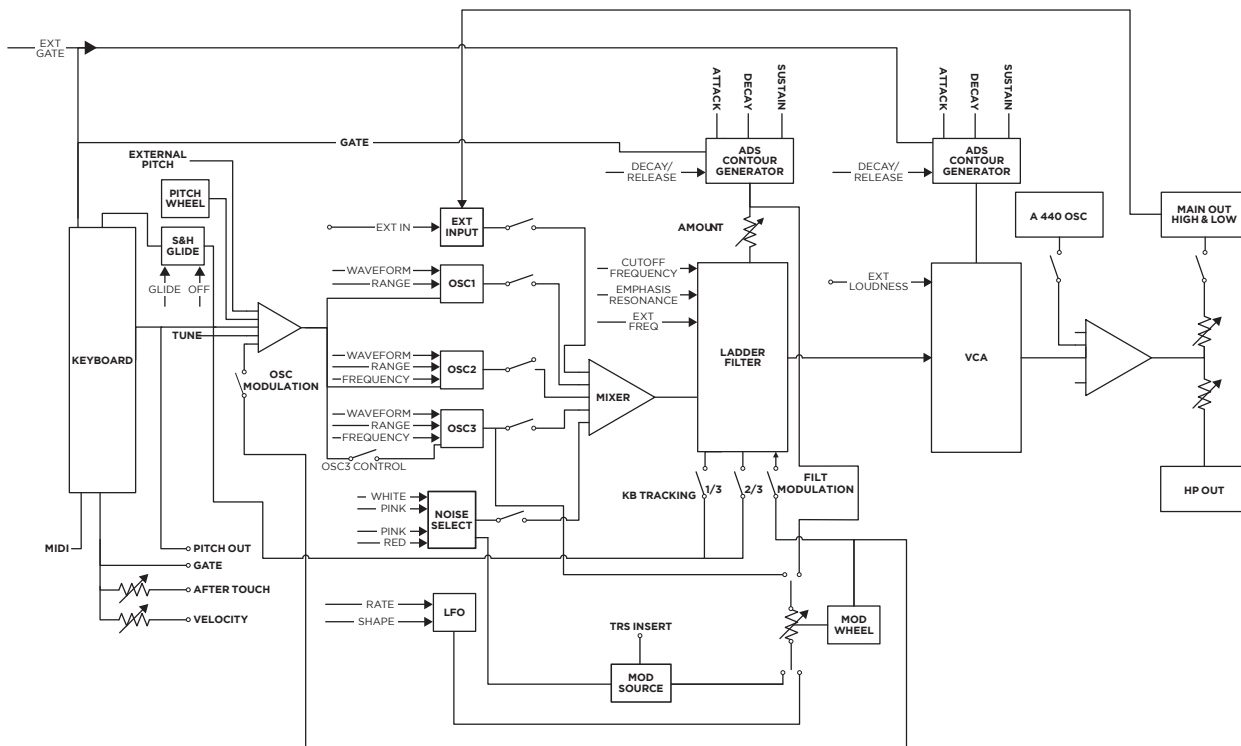

OVERVIEW

The Minimoog Model D is a self-contained monophonic analog synthesizer, and the direct descendant of the Moog modular synthesizers that preceded it. The main synthesizer components include:

- Oscillator-1
- Oscillator-2
- Oscillator-3
- Noise Generator
- LFO Modulation Oscillator
- Audio Mixer
- Filter
- Filter Contour (Envelope Generator)
- Loudness Contour (Envelope Generator)
- 44 full-size keys with Velocity and After Pressure
- Pitch Bend and Modulation Wheels and Glide
- Enhanced Patch Panel

The front panel groups these elements and controls together by type: **CONTROLLERS, OSCILLATOR BANK, MIXER, MODIFIERS, OUTPUT** in an intuitive and efficient design. All of these elements are controlled via single-function knobs and switches. And like its modular ancestors, the Minimoog Model D is constructed of independent synthesizer circuits connected by audio pathways and control lines. In place of patch cables, the Minimoog Model D uses color-coded rocker switches to establish connections between these circuit elements, or modules.

- Orange Switches: Connect modulation sources to their destinations.
- Blue Switches: Turn audio sources On and Off.
- White Switches: Turn performance features On and Off.
- Black Switches: Select between modulation sources.

OSCILLATOR BANK

Oscillators are the primary source of sound in an analog synthesizer. The Minimoog Model D **OSCILLATOR BANK** contains three nearly identical Oscillators. This arrangement means each key can sound up to three oscillators—each with its own Waveform, Octave, and Pitch setting—creating a deep or complex sound. The Mixer then controls the balance between the Oscillators.

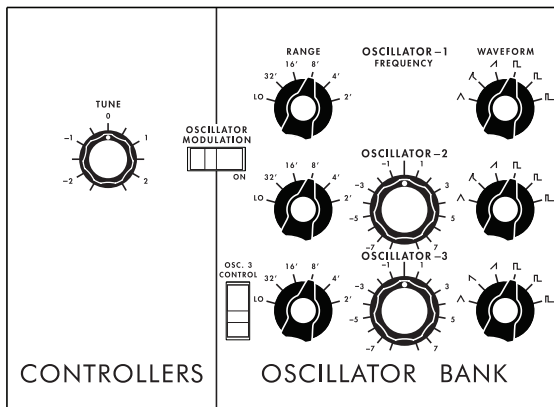

TUNE

The tuning of Oscillator-1 is determined by the master **TUNE** knob, located at the top of the **CONTROLLERS** panel.

RANGE

The **RANGE** knob selects the fundamental octave for each oscillator over a five octave range. A sixth **LO** setting brings the pitch down even further, allowing the Oscillator to be used for other purposes, such as a modulation source.

FREQUENCY

Oscillator-2 and Oscillator-3 are each equipped with a **FREQUENCY** knob that can be used to detune the Oscillator from the pitch of Oscillator-1. Slight amounts of detuning can create a rich, chorusing effect. Tuning the Oscillators to an interval (Perfect Fifth above, Perfect Fourth below, etc.) provides a powerful voice for playing lead passages or creating chords.

WAVEFORM

Each of the three Oscillators provides six distinct Waveform shapes. Each waveform has a unique harmonic content that is based on the number and strength of harmonic overtones that it contains. These overtones are what impart a particular timbre to the Oscillator.

TRIANGLE

The Triangle wave has an extremely strong fundamental, yet contains only odd-numbered harmonics at very low levels. This makes the Triangle wave an ideal choice for creating soft, flute-like sounds that have a pure tone with little overtone activity.

TRIANGLE/SAWTOOTH (OSCILLATOR-1 AND OSCILLATOR-2 ONLY)

This waveform is a hybrid of the Triangle and the Sawtooth waveforms. It contains more harmonic energy than the Triangle wave and adds in some of the even-numbered harmonics, but it is not nearly as brash as the Sawtooth wave. This hybrid waveform can add a little more edge than the Triangle wave alone, allowing it to cut through the mix with a bit more clarity.

REVERSE SAWTOOTH (OSCILLATOR-3 ONLY)

The Reverse Sawtooth has a sound similar to the regular Sawtooth wave; it is included here primarily as a waveform choice when using Oscillator-3 as a modulation source.

SAWTOOTH

The Sawtooth waveform is the most harmonically dense of the waveforms, containing all of the natural harmonics in relatively strong levels. In addition to creating thick, brassy sounds, the Sawtooth waveform lends itself to powerful lead and bass sounds as well.

WAVEFORM (Continued)

PULSE 1 / SQUARE

The harmonic content of a Pulse wave is based on the width of the top half of the wave in relation to the bottom half of the wave, also known as the duty-cycle. In the Square wave, the width of these two portions of the wave are equal. As with the Triangle wave, the Pulse 1/Square waveform contains only odd-numbered harmonics, but with greater energy. A Square wave provides a rich starting point for string-like sounds.

PULSE 2 / WIDE RECTANGLE

As the Pulse wave changes from Square to Rectangular, even numbered harmonics are introduced, but the overall harmonic mix is changed. The wide rectangle forms the basis for hollow, reedy sounds.

PULSE 3 / NARROW RECTANGLE

As the Pulse wave continues to get narrower, lower numbered harmonics—both odd and even—are emphasized. The resulting timbre takes on a more nasal tone.

***TIP:** Mixing a Triangle wave from one Oscillator with the more complex wave of another Oscillator allows you to emphasize one particular harmonic without adding unwanted overtones. Changing the relative tuning of the Triangle wave Oscillator can enhance this effect.*

OSC. 3 CONTROL

Oscillator-3 is unique. Normally, all Oscillators are controlled directly from the keyboard and Pitch wheel. Turning the orange rocker switch to **OFF** releases **OSCILLATOR-3** from keyboard control, providing a greater range of frequency control and allowing it to run free as a modulation source.

OSCILLATOR MODULATION

When this switch is set to **ON**, the Oscillators can be modulated by Oscillator 3, Noise, Filter Contour, an External Mod Source, and the LFO (Low Frequency Oscillator) as defined by the **CONTROLLERS** settings and the Modulation Wheel position.

CONTROLLERS

The Minimoog Model D contains a number of modulation sources that can affect the pitch of the Oscillators or the Cutoff Frequency of the Filter. In this regard, the Minimoog Model D has been modified from its original design, and two black rocker switches have been added to the **CONTROLLERS** section. Each switch selects between two modulation sources, while the Modulation Mix knob controls the balance between them. In the end, the Modulation Wheel (located on the Left-Hand Keyboard panel) controls the amount of modulation applied to the Oscillators and or Filter.

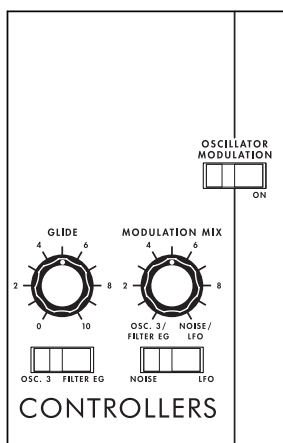

OSC. 3/FILTER EG SWITCH

This switch to the bottom left side of the **CONTROLLERS** panel is used to choose the modulation source that will be assigned to the counterclockwise position of the **MODULATION MIX** knob. Normally, this switch would be set to **OSC. 3**, allowing Oscillator-3 to be assigned as a modulation source. In the **FILTER EG** position, the shape defined by the **ATTACK TIME**, **DECAY TIME**, and **SUSTAIN LEVEL** knobs of the Filter Contour are used as a modulation source. Filter EG is an ideal modulation source for creating analog brass and percussion sounds.

CONTROLLERS (Continued)

NOISE/LFO SWITCH

This switch to the bottom right side of the **CONTROLLERS** panel is used to choose the modulation source that will be assigned to the clockwise position of the **MODULATION MIX** knob. Normally, this switch would be set to **NOISE**, allowing the Noise Generator to be assigned as a modulation source. The **NOISE** switch located in the mixer selection determines what type of noise is used for modulation. When **WHITE NOISE** is selected, Pink Noise is actually the modulation source. When **PINK NOISE** is selected, Red Noise is actually the modulation source. In the LFO position, the additional LFO located on the Left-Hand Keyboard panel is used as a modulation source. This is ideal for pitch vibrato and trills when all three oscillators are in use.

***TIP:** The Noise position can also be used to introduce an external modulation source via the **MOD. SRC.** (Modulation Source) jack on the Top Patch Panel. Inserting a standard 1/4" TS cable into this jack breaks the normalled connection, and any external control voltage can be used as a modulation source. Additionally, if a TRS to TS insert cable is used, the Modulation Noise signal output is made available on the ring/send portion of the cable.*

MODULATION MIX

This knob sets the balance between the modulation sources selected using the **OSC.3/FILTER EG** and **NOISE/LFO** switches. With the **MODULATION MIX** knob rotated fully counterclockwise, only the modulation source selected by the **OSC.3/FILTER EG** switch is applied. With the **MODULATION MIX** knob rotated fully clockwise, only the modulation source selected by the **NOISE/LFO** switch is applied. In the center position, both selected modulation sources are applied equally.

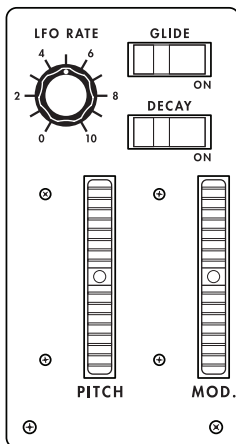

LEFT-HAND KEYBOARD PANEL

LFO RATE

Located on the Left-Hand Keyboard panel, the **LFO RATE** knob sets the speed for the dedicated LFO (Low Frequency Oscillator) modulation source that has been added to the Minimoog Model D. Normally, the LFO uses a Triangle wave; pulling up slightly on the **LFO RATE** knob will switch the LFO to a Square wave.

MOD WHEEL

The **MODULATION** Wheel provides a real-time performance controller that can apply the modulation sources selected using the **OSC.3/FILTER EG** and **NOISE/LFO** switches, using the mix determined by the **MODULATION MIX** knob. The Oscillator Modulation switch between the **CONTROLLERS** panel and the **OSCILLATOR BANK** must be in the **ON** position to apply modulation

to the Oscillator pitch. The **FILTER MODULATION** switch connecting the **CONTROLLER** panel and the Filter must be in the **ON** position to apply modulation to the Filter Cutoff Frequency. The zero position for the Mod Wheel is all the way down, with the indent in the wheel closest to you.

***NOTE:** The **MODULATION** Wheel does not transmit or receive MIDI data due to its traditional passive attenuator design.*

PITCH WHEEL

Located next to the **MODULATION** Wheel, the **PITCH** Wheel provides a real-time performance controller for bending the pitch of the Oscillators, in the way that a guitarist may bend a string or a sax player may bend the reed to alter the pitch of a note. The zero position for the **PITCH** Wheel is in the center, allowing the pitch to be bent either sharp or flat.

***NOTE:** The **PITCH** Wheel on the Minimoog Model D does not have a spring-loaded return, but does have a center-detent.*

LEFT-HAND KEYBOARD PANEL *(Continued)*

GLIDE

Glide allows the pitch to change in a smooth, continuous manner as you transition from note to note, rather than instantly stepping to the new pitch.

GLIDE SWITCH

Located on the Left-Hand Keyboard panel, this switch turns the Glide effect on and off.

GLIDE KNOB

Located on the **CONTROLLERS** panel, the **GLIDE** knob determines the amount of time needed to transition from one note to the next.

DECAY SWITCH

When the **DECAY** switch is **ON**, the last note played will continue to sound as it fades and the Filter Cutoff Frequency will lower at the rate set using the **DECAY TIME** knobs in the **MODIFIERS** section. (Page 16).

MIXER & NOISE

The **MIXER** sets the levels of all five of the Minimoog Model D audio sources—3 Oscillators, Noise Generator, and External Audio Input. The combined output of the Mixer next passes through the Filter and finally arrives at the audio output. In addition to a dedicated Volume knob, each audio source also includes an On/Off switch. These switches allow any source to be quickly removed from the mix while preserving their **VOLUME** knob position, and can also be useful when setting the tuning of each Oscillator.

The Oscillators are somewhat self-explanatory in regard to the Mixer. The External Input Volume and the Noise Generator require some extra explanation.

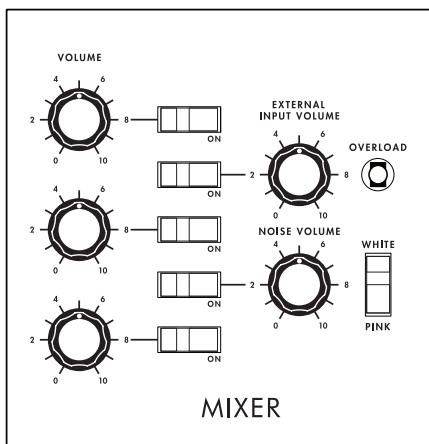

EXTERNAL INPUT VOLUME

An external audio source can be introduced to the Minimoog Model D using the **EXT. INPUT SIGNAL** jack located on the Top Patch Panel. The Volume of the external signal is controlled using this knob.

If no cable is connected to the **EXT. INPUT SIGNAL** jack, the main audio output of the Minimoog Model D is attenuated slightly and then normalled to the External Input signal path. In this case, the Main Output signal is sent back to the input of the mixer. By increasing the External Input volume far enough, the Mixer can overload, introducing varying levels of overdrive or distortion. When this occurs, the Overload indicator lamp will light. In this case, the External Input Volume control is **POST** Main Output volume. This means that the **MAIN OUTPUT VOLUME** knob will affect the amount of overload in addition to the **EXTERNAL INPUT VOLUME** knob.

CRITICAL NOTE: With no cable connected to the **EXT. INPUT SIGNAL** jack, and the **EXTERNAL INPUT VOLUME** and **MAIN OUTPUT VOLUME** controls turned all the way up, it is possible to overload the mixer to the point that only one sound is heard and different pitches do not sound. This will not damage the instrument.

NOISE

Noise can be a very desirable sound source—either alone, or mixed in with other sources. It can be used to create anything from a rocket launch to the subtle breath of a flute sound. In addition to the **NOISE VOLUME** knob, there is a switch for selecting either **WHITE** or **PINK** noise. White Noise contains all audible frequencies at equal amplitude levels, much like white light. Pink Noise contains equal energy in each band of the audio spectrum, and is perceived as having more low-frequency components. If you think of White Noise as TV static, consider Pink Noise more as a waterfall pounding the rocks below.

MODIFIERS

The **MODIFIERS** Panel contains three separate sections: **FILTER**, **FILTER CONTOUR**, and **LOUDNESS CONTOUR**. The Filter selectively modifies the harmonic content of the sound. The Contour controls, also known as Envelope Generators, provide a control signal that changes over time. The **FILTER CONTOUR** controls the filter's Cutoff Frequency over time. The **LOUDNESS CONTOUR** controls the output volume level over time.

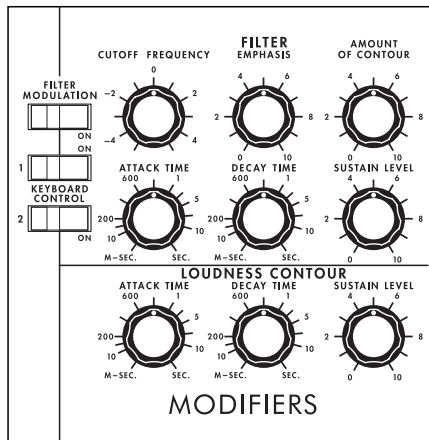

FILTER CONTROLS

CUTOFF FREQUENCY KNOB

The Minimoog Model D is equipped with a traditional Moog Ladder Filter with 10Hz-32kHz frequency response. This is a critical component to the thick, punchy and powerful Minimoog Model D sound. When a note is played, harmonic content occurring above the filter Cutoff Frequency is reduced by the filter at a rate of 24dB/Octave. Harmonic content, or sound, below the filter Cutoff Frequency will freely pass unaffected. This is the foundation of subtractive analog synthesis. While the Cutoff Frequency can be set manually using the **CUTOFF FREQUENCY** knob, the value is also affected by the **KEYBOARD CONTROL** switches, **FILTER MODULATION** switch, **FILTER CONTOUR** controls

and the **AMOUNT OF CONTOUR** knob, which are discussed below. When closing the filter by lowering the **CUTOFF FREQUENCY**, the sound will be perceived as growing darker, while increasing the Filter's **CUTOFF FREQUENCY** will create a progressively brighter sound.

EMPHASIS KNOB

Often referred to as resonance, the **EMPHASIS** knob takes a portion of the output of the Filter and sends it back to the input of the Filter, creating a resonance peak that occurs at the filter's Cutoff Frequency. By turning the **EMPHASIS** control up and lowering the Filter **CUTOFF FREQUENCY**, the Filter can be coaxed into a self-oscillating state, acting as a sine-wave oscillator whose pitch can be controlled or played via the keyboard by using the **KEYBOARD CONTROL** switches defined below.

FILTER MODULATION SWITCH

When this switch is On, the Filter Cutoff Frequency can be modulated by the Noise Generator, Filter Contour, Oscillator 3, and the LFO (Low Frequency Oscillator). The modulation source and amount are defined by the **CONTROLLERS** settings and the **MODULATION WHEEL** position.

KEYBOARD CONTROL (1 & 2) SWITCHES

The **KEYBOARD CONTROL** switches allow the note played on the keyboard of the Minimoog Model D to affect the Filter Cutoff Frequency, a process also known as key tracking. This allows notes played higher on the keyboard to have brighter sound. **KEYBOARD CONTROL 1** provides 1/3 of the total amount of available key tracking. **KEYBOARD CONTROL 2** provides 2/3 of the total amount of available key tracking. By using both switches together, the full amount of available key tracking ($1/3 + 2/3 = 1$) is applied.

MODIFIERS *(Continued)*

COUNTOUR CONTROLS

Contour controls provide a way to add articulation to the sound of the synthesizer. The Minimoog Model D features two Contour, or Envelope Generators. One provides a signal to change the Filter Cutoff Frequency over time. The second provides a signal to change the Loudness over time. In both cases, the Contour contains three main controls: **ATTACK TIME**, **DECAY TIME**, and **SUSTAIN LEVEL**.

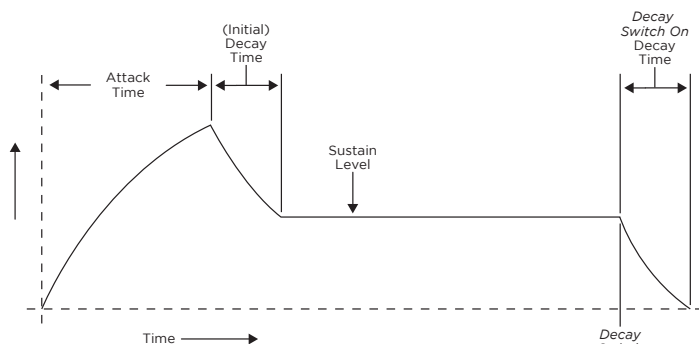

FILTER CONTOUR

ATTACK TIME KNOB

The **ATTACK TIME** knob sets the time required for the Filter Contour Generator to raise the Filter's Cutoff Frequency from its manual setting to its maximum level (determined by the **AMOUNT OF CONTOUR** knob) once a key is pressed or after a gate is received.

DECAY TIME KNOB

The **DECAY TIME** knob sets the time required for the Filter Contour Generator to lower the Filter's Cutoff Frequency from the level achieved by the Attack stage to the Sustain Level. The **DECAY TIME** knob can also control the amount of time required for the Filter to return to its manual setting after the key is released (or after an external gate signal ends). This second function of the **DECAY TIME** knob is activated by the **DECAY** switch, located on the Left-Hand Keyboard panel.

SUSTAIN LEVEL KNOB

After the Attack and Decay stages have been completed, the Filter Contour Generator will hold the Filter's Cutoff Frequency at the level determined by the **SUSTAIN LEVEL** knob for as long as a note is held.

AMOUNT OF CONTOUR KNOB

The **AMOUNT OF CONTOUR** knob determines how much of the control signal created by the Filter Contour will be applied to change the Filter Cutoff Frequency over time.

LOUDNESS CONTOUR

ATTACK TIME KNOB

The **ATTACK TIME** knob sets the time required for the Loudness Contour Generator to raise the Volume from zero to its maximum level once a key is pressed or after a gate is received.

DECAY TIME KNOB

The **DECAY TIME** knob sets the time required for the Loudness Contour Generator to lower the Volume from its maximum level achieved by the Attack stage to the Sustain Level. The **DECAY TIME** knob can also control the amount of time required for the note to completely fade out after a key is released (or after an external gate signal ends). This second function of the **DECAY TIME** knob is activated by the **DECAY** switch, located on the Left-Hand Keyboard Panel.

SUSTAIN LEVEL KNOB

After the Attack and Decay stages have been completed, the Loudness Contour Generator will maintain the Volume level determined by the **SUSTAIN LEVEL** knob for as long as a note is held.

OUTPUT

The **OUTPUT** section is divided into three functions—**MAIN OUTPUT**, **PHONES OUTPUT**, and the **A-440** Reference Tuner. The **MAIN OUTPUT** and the **PHONES OUTPUT** feature independent Volume controls. The Main Output also offers an On/Off switch.

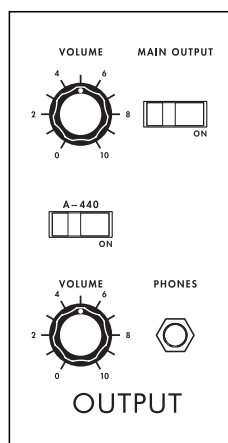

MAIN OUTPUT VOLUME KNOB

The **MAIN OUTPUT VOLUME** knob determines the signal level being sent to the **HIGH** and **LOW** audio outputs on the Top Patch Panel.

NOTE: The Low output signal is 30 dB lower than the High level output.

MAIN OUTPUT SWITCH

This switch can quickly mute the Main Output of the instrument without having to dial the Volume down to zero and then reset it to a nominal level. Muting the Main Output allows a performer to use the Phones Output as a cue/monitor for privately tweaking settings during a live performance.

A-440 TUNER SWITCH

A reference tuner pitched at A=440 Hz is built into the Minimoog Model D. The reference tone is sent to both the Main Output and the Phones Output. The Tuner provides a convenient way to keep all of the oscillators in tune, at all times.

PHONES VOLUME KNOB

The **PHONES VOLUME** knob determines the signal level being sent to the **PHONES** jack. This knob operates independent of the **MAIN OUTPUT VOLUME** knob.

PHONES JACK

Even though the Minimoog Model D is monophonic, the **PHONES** jack is a 1/4" TRS Stereo jack, delivering the same signal to both ears.

TIP: Mute the Main Output and use a pair of headphones to monitor the Minimoog Model D in order to prepare the next sound or to check the tuning.

KEYBOARD

The keyboard of the Minimoog Model D features 44 keys, or three and a half octaves, from F to C. Playing a note will transmit control voltage information to the Oscillators, Keyboard Tracking information to the Filter, and will trigger both of the Contour Generators. The original keyboards used on the Minimoog Model D in the 1970s have long since vanished, so a new Fatar TP-9 keyboard is used. This new keyboard introduces features that have long been desired by Minimoog Model D owners, without compromising the integrity of the instrument. The keyboard can now transmit MIDI information, generate a Velocity control voltage signal and also an After-Pressure control voltage signal. These additional control signals are available as CV outputs on the Top Patch Panel in addition to analog Pitch CV and Gate outputs.

TIP: Using Power-On Commands, the performance of the keyboard can be customized. For example, traditionally the Minimoog Model D used Low-Note Priority; this can now be set to Last-Note priority. To learn more about Power-On commands, go to page 22 of this manual.

TOP PATCH PANEL

While not a modular synthesizer, the Minimoog Model D features an enhanced Patch Panel to interface with other analog synthesizers and musical equipment via Control Voltage, Trigger signals and MIDI. This Patch Panel also expands the expressive performance capabilities of the Minimoog Model D itself. The Patch Panel is located along the top edge of the synthesizer.

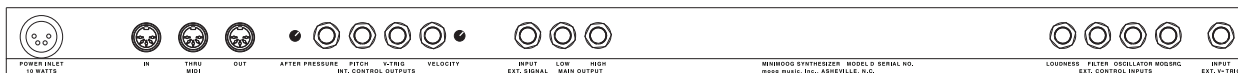

MIDI PORTS

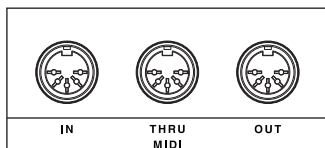

MIDI IN

The Minimoog Model D can receive MIDI Note, Velocity, and Pitch Bend information, as well as SysEx commands.

MIDI OUT

The Minimoog Model D can send MIDI Note, Velocity, and Pitch Bend information, as well as Aftertouch.

MIDI THRU

This jack rebroadcasts the signal arriving at the MIDI IN jack, and passes it along to other MIDI equipment.

CONTROL OUTPUTS

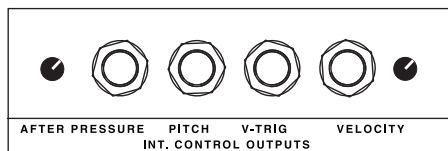

PITCH OUT

This jack sends a control voltage signal based on the Pitch of the note being played on the keyboard. This output is not affected by the position of the Pitch wheel. The default setting is for the key C0 to generate zero volts; however this note is not accessible from the keyboard itself. Using the Pitch CV Zero Volt Power On Command (see page 22), you can specify a particular key to have a control voltage value of zero volts.

VELOCITY OUT

This jack sends a control voltage signal based on the Velocity used to play a note on the keyboard. There is a small trimpot located adjacent to this jack that is used for attenuating the level of the Velocity control voltage signal.

AFTER PRESSURE OUT (AFTERTOUCH)

This jack sends a control voltage signal based on the After Pressure that is generated by pressing down further on a key that is already being held down on the keyboard. There is a small trimpot located adjacent to this jack that is used for attenuating the level of the After Pressure control voltage signal.

V-TRIG OUT

This 1/4" jack sends a Trigger signal each time a note is played. It uses a standard V-Trigger connector in place of the S-Trigger and Cinch-Jones hardware used on the original Minimoog Model D.

AUDIO OUTPUTS

There are two Main audio outputs: **LOW** level, and **HIGH** level.

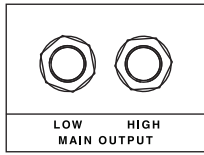

MAIN OUTPUT LOW JACK

This is the most commonly used output for connecting to guitar amplifiers, DI inputs on a preamplifier, etc...

MAIN OUTPUT HIGH JACK

This is the most commonly used output for connecting to the line input of a mixer, audio interface, keyboard amplifier etc...

AUDIO INPUT

An external audio source can be introduced into the Minimoog Model D via this input jack. The signal appears at the **EXTERNAL INPUT** switch and **VOLUME** knob in the **MIXER** panel. This allows an external audio signal to be processed, gated, and filtered by the Minimoog Model D.

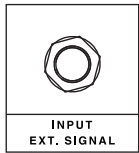

EXT. SIGNAL INPUT JACK

Connect the audio output cable from your external sound source to this input jack. If no cable is connected here, the output of the Minimoog Model D is attenuated and then normalled to the External Input signal path. In this case, increasing the level of the **EXTERNAL INPUT VOLUME** knob on the **MIXER** panel will reintroduce the output signal of the instrument back to the input of the mixer. By increasing the External Input volume far enough, the Mixer can overload, introducing varying levels of overdrive or distortion. When this occurs, the **OVERLOAD** indicator lamp will light, regardless of whether or not the **EXTERNAL INPUT** switch is set to **ON** or **OFF**.

NOTE: The scaling of overdrive is directly related to the **MAIN OUTPUT VOLUME** knob. Because of this, it is ideal to keep the **MAIN OUTPUT VOLUME** knob at or below 6 for the most musical range of overdrive control via the **EXTERNAL INPUT VOLUME** knob.

CONTROL INPUTS

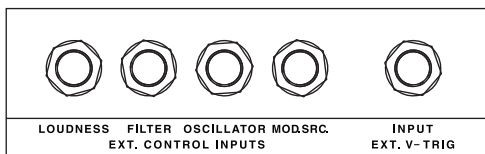

OSCILLATOR INPUT JACK

A 1 V/Octave additive control voltage signal connected to this input jack will affect the pitch of the Oscillators.

LOUDNESS INPUT

A 0 to +5 volt control voltage signal connected to this input jack will affect the overall level of the Loudness Contour.

FILTER INPUT

A 0 to +5 volt control voltage signal connected to this input jack will affect the Cutoff Frequency of the Filter.

NOTE: The **OSCILLATOR**, **VELOCITY**, and **FILTER** input jacks are equipped with TRS (Tip/Ring/Sleeve) connectors with a current-limited +5V on the ring. This allows each parameter to be controlled via control voltage signal or from a Moog EP-3 expression pedal.

CONTROL INPUTS *(Continued)*

V-TRIG IN

This 1/4" jack can receive a standard V-Trigger from other electronic instruments. It uses a standard V-Trigger connector in place of the S-Trigger and Cinch-Jones connector used on the original Minimoog Model D. A trigger signal received here will cause the Contour Generators to fire and will act as a keyboard gate.

MOD. SRC. INPUT

A varying control voltage signal connected to this input jack can be used as a modulation source. Inserting a standard 1/4" cable into this jack breaks the normalled connection of the Noise modulation source, and any external control voltage applied will take its place. With no cable connected, this jack remains normalled, connecting the Noise send to the **MOD. SRC.** input, and **NOISE** can be selected as a modulation source.

***TIP:** This jack is equipped with a TRS (Tip/Ring/Sleeve) connector, which allows it to also function as a send for the Noise Generator. With **WHITE NOISE** selected, the modulation source becomes Pink Noise. With **PINK NOISE** selected, the modulation source becomes Red Noise.*

PERFORMANCE TIPS & TECHNIQUES

Even with its streamlined control panel, the Minimoog Model D remains a deep and versatile instrument for audio synthesis. Here are just a few examples of how the Minimoog Model D may be used in interesting and perhaps unexpected ways.

PROCESSING EXTERNAL AUDIO

Using a Moog Ladder Filter to process external sounds can lead to extremely creative explorations. Try filtering another keyboard, a guitar, found sounds, etc.

1. Connect the external audio source to the Minimoog Model D via the **EXT. SIGNAL INPUT** jack on the Top Patch Panel. (The level is set using the **EXTERNAL INPUT VOLUME** knob on the **MIXER** panel.)
2. Be sure the blue rocker switch for the **EXTERNAL INPUT VOLUME** is **ON**. For now, set the other blue rocker switches to **OFF** so you can isolate the external signal.
3. In order to hear the signal being filtered, the Contour Generators need to be triggered. This can be done by touching the keyboard, or by using an external trigger from a drum machine, additional synthesizer, etc. Ensure the orange **FILTER MODULATION** rocker switch is set to **ON** or the Contour Generator will have no effect on the filter.
4. Using the Modulation Wheel can introduce more complex filtering effects. For example, set the black **NOISE/LFO** rocker switch to **LFO**, set the orange **FILTER MODULATION** switch to **ON** and rotate the **MODULATION MIX** knob fully clockwise.
5. Next, pull up on the **LFO RATE** knob to select a square wave.
6. Finally, as the external source is playing, hold down any note on the Keyboard and push the **MODULATION** Wheel forward to create a pulsed filter effect. Adjust the **LFO RATE**, **FILTER CUTOFF FREQUENCY**, and **EMPHASIS** knobs accordingly.

PERFORMANCE TIPS & TECHNIQUES *(Continued)*

ENHANCING A KEYBOARD PERFORMANCE

In this example, the expressive capabilities of the Minimoog Model D Keyboard are enhanced by adding Velocity control to the volume and After Pressure control to the filter brightness.

1. Connect a 1/4" TS to 1/4" TS instrument cable from the **VELOCITY** Control Output to the **LOUDNESS** Ext. Control Input. Now, the velocity with which a note is played will affect the Loudness, or output volume of the Model D. Use the adjustable trimpot adjacent to the **VELOCITY INT.** Control Output to determine the amount of velocity control.
2. Next, connect a 1/4" TS to 1/4" TS instrument cable from the **AFTER PRESSURE** Control Output to the **FILTER EXT** Control Input. By applying small amounts of pressure to a key while holding a note, the Filter Cutoff Frequency will change, allowing the note to appear brighter in tone or timbre. Use the adjustable trimpot adjacent to the **AFTER PRESSURE** Control Output to determine the amount of After Pressure control.

CREATING FM EFFECTS

Often when we think of Modulation, we are thinking of adding a slow cyclic change in pitch, filter brightness, etc. The Minimoog Model D also allows one audio oscillator to modulate another, creating interesting Frequency Modulation effects.

1. Set **OSCILLATOR-1** to the **16'** or **8'** Range.
2. Set **OSCILLATOR-3** to the **16'** or **8'** Range.
3. Isolate **OSCILLATOR-3** from keyboard control by setting the orange **OSC.3 CONTROL** rocker switch to **OFF**.
4. In the **CONTROLLERS** section, set the black **OSC.3/FILTER EG.** rocker switch to **OSC.3** and rotate the **MODULATION MIX** knob fully counterclockwise.
5. Turn Off all audio inputs to the **MIXER** panel—except **OSCILLATOR-1**—using the blue rocker switches.
6. Hold any note on the Keyboard, and use the **MODULATION** Wheel to apply Frequency Modulation to Oscillator-1 using Oscillator-3. The FM effect can be controlled by the position of the Modulation Wheel, as well as the Range, Frequency, and Waveform settings of Oscillator-3.

CREATIVE SWITCHING

With a little forethought, the blue and orange rocker switches on the Minimoog Model D can be used to quickly introduce new elements to your performance. For example, by tuning Oscillator-2 and Oscillator-3 to specific intervals in regards to Oscillator-1, extra harmonies or chords can be added to your performance as you play.

1. Tune **OSCILLATOR-2** to a Fifth (5) above **OSCILLATOR-1**.
2. Tune **OSCILLATOR-3** to a Fourth (-4) below **OSCILLATOR-1** (be sure that the orange **OSC. CONTROL** rocker switch is **ON**).
3. In the **MIXER** panel, use the blue rocker switches to turn **OSCILLATOR-1 ON**, and **OSCILLATOR-2** and **OSCILLATOR-3 OFF**.
4. Now, as you play a lead, you can use the blue **OSCILLATOR-2** and **OSCILLATOR-3** rocker switches to instantly add a parallel harmony voice.

GLOBAL SETTINGS

Under the hood, the Minimoog Model D is equipped with a number of global functions that expand the versatility of the instrument. Some of these functions are accessed via Power-On commands, while others are accessed via MIDI SysEx (System Exclusive) messages—or both. SysEx documentation can be downloaded at moogmusic.com.

POWER-ON COMMANDS

By holding down specific keys on the keyboard during power-on, you can access certain Global settings, referred to in this manual as Power-On Commands. These Commands can only be activated one at a time, but their effect is cumulative. Power-On Commands are retained by the Minimoog Model D, even when the power has been turned off.

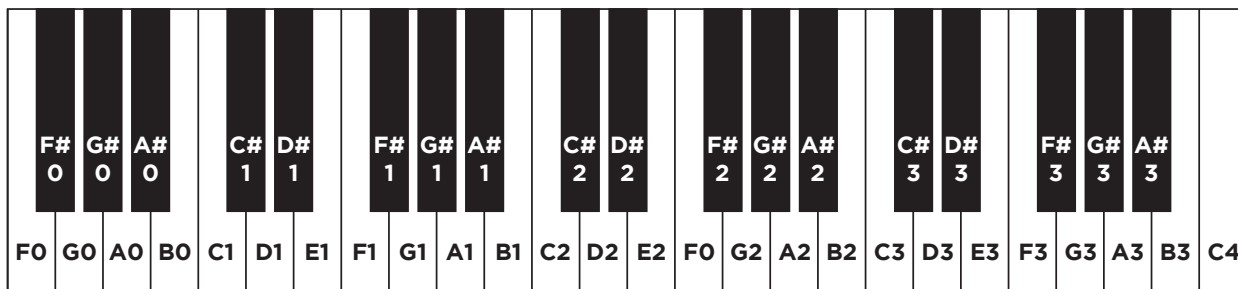

GLOBAL RESET

To return the instrument to its original factory settings, simply press and hold the lowest four white keys on the keyboard (F0, G0, A0, B0) while turning on the power.

NOTE PRIORITY POWER-ON COMMANDS

The Priority function specifies which note will take priority when more than one note is played at a time on the keyboard—the last note played, the highest note, or the lowest note.

LAST NOTE PRIORITY

Hold this C Major chord (C3, E3, G3) while turning on the power to choose Last Note Priority.

LOW NOTE PRIORITY

Hold this C minor chord (C3, Eb3, G3) while turning on the power to choose Low Note Priority. This is the default setting and how a classic Model D behaves.

HIGH NOTE PRIORITY

Hold this C augmented chord (C3, E3, G#3) while turning on the power to choose High Note Priority.

LEGATO TRIGGERING POWER-ON COMMANDS

When multiple triggering is enabled, each new note played on the keyboard will send a new pitch to the Oscillators, and will trigger the Filter and Loudness Contour Generators. By disabling multiple triggering (Legato Mode), the Contour Generators will only trigger if all notes have been released on the keyboard before a new note is played. The Legato Mode allows you to hold one note on the keyboard, and then play a new note before the previous note is released. The pitch will change, but the Filter and Loudness settings will remain the same as the new note sounds.

MULTI-TRIGGER ON

Hold this D Major chord (D3, F#3, A3) while turning on the power to set Multi-Triggering to On.

MULTI-TRIGGER OFF (LEGATO MODE)

Hold this D Minor chord (D3, F3, A3) while turning on the power to set Multi-Triggering to Off.

GATE SOURCE POWER-ON COMMANDS

Determines which sources will trigger the Keyboard Gate and Contour Generators.

EXTERNAL GATE

Hold F2 + A2 while turning on the power to select External Gate sources only

EXTERNAL AND LOCAL KEYS (NO MIDI)

Hold F2 + Bb2 while turning on the power to select External and Local Keys as Gate sources only.

EXTERNAL AND MIDI (NO LOCAL KEYS)

Hold F2 + B2 while turning on the power to select External and MIDI as Gate sources only.

EXTERNAL, MIDI AND LOCAL KEYS (ALL)

Hold F2 + C3 while turning on the power to select all Gate sources (Default).

VELOCITY CONTROL VOLTAGE RANGE POWER-ON COMMANDS

The voltage range of the Velocity control output can be doubled from five volts to ten volts in order to accommodate different types of analog equipment.

VELOCITY CV RANGE = 5 VOLTS

Hold G0 + C#1 while turning on the power to limit the Velocity CV range to five volts.

VELOCITY CV RANGE = 10 VOLTS

Hold G0 + D1 while turning on the power to expand the Velocity CV range to ten volts.

KEYBOARD TUNING ERROR POWER-ON COMMAND

The Pratt-Read keyboard on the original Minimoog Model D used a fixed resistor network on each key to set the pitch. This feature can recreate the tuning errors caused by variations in the resistor values to add a more vintage sound and feel to the instrument. When On, a random error value (within 10 cents), to replicate the tolerance values of the original resistors will be applied to each key; the error value remains constant each time the key is played.

KEYBOARD TUNING ERROR ON

Hold F1 + C2 while turning on the power to turn Keyboard Tuning Error On.

KEYBOARD TUNING ERROR OFF

Hold F1 + B1 while turning on the power to turn Keyboard Tuning Error Off.

MIDI POWER-ON COMMANDS

SETTING THE MIDI CHANNEL

Hold A#3 and press any of the lowest 16 lowest keys while turning on the power to set the MIDI Channel. The MIDI IN and MIDI OUT Channel are always the same.

MIDI IN TRANSPOSE

Hold C4 and press any key in the octave above or below C2 while turning on the power to transpose the MIDI IN note data by +/- 12 semitones.

MIDI OUT TRANSPOSE

Hold B3 and press any key in the octave above or below C2 while turning on the power to transpose the MIDI OUT note data by +/- 12 semitones.

MIDI PITCH WHEEL ON

Hold F0 + C1 while turning on the power to transmit Pitch Bend data via MIDI.

MIDI PITCH WHEEL OFF

Hold F0 + B0 while turning on the power to disable the transmission of Pitch Bend data via MIDI.

MIDI POWER-ON COMMANDS (Continued)

MIDI AFTERTOUCH ON

Hold G0 + C1 while turning on the power to transmit Aftertouch (After Pressure) data via MIDI.

MIDI AFTERTOUCH OFF

Hold G0 + B0 while turning on the power to disable the transmission of Aftertouch (After Pressure) data via MIDI.

MIDI LOCAL ON

Hold the highest three white keys (A3, B3, C4) while turning on the power to turn MIDI Local On.

MIDI LOCAL OFF

Hold the highest three black keys (F#3, G#3, A#3) while turning on the power to turn MIDI Local Off.

***TIP:** By transposing the MIDI note output, you can command a slave MIDI synthesizer to play in parallel harmony with the Minimoog Model D. Additionally, by setting MIDI Local to Off and transposing the MIDI note output, you can play in any key while using normal fingering.*

MIDI VELOCITY CURVES

MIDI VELOCITY CURVE SOFT

Hold this C minor chord (C2, Eb2, G2) while turning on the power to choose the soft MIDI Velocity Curve.

MIDI VELOCITY CURVE MEDIUM

Hold this C Major chord (C2, E2, G2) while turning on the power to choose the medium MIDI Velocity Curve.

MIDI VELOCITY CURVE HARD

Hold this C Augmented chord (C2, E2, G#2) while turning on the power to choose the hard MIDI Velocity Curve.

MIDI TUNING TABLE POWER-ON COMMANDS

STANDARD TUNING (ALTERNATE TUNING TABLE OFF)

Hold G1 + B1 while turning on the power to use the default tuning.

CUSTOM TUNING TABLE 1: PYTHAGOREAN C SCALE

Hold G1 + C2 while turning on the power to select Tuning Table 1 from memory.

CUSTOM TUNING TABLE 2: WENDY CARLOS HARMONIC 12-TONE SCALE

Hold G1 + D2 while turning on the power to select Tuning Table 2 from memory.

CUSTOM TUNING TABLE 3: HARRY PARTCH 43-TONE SCALE

Hold G1 + E2 while turning on the power to select Tuning Table 3 from memory.

PITCH CV ZERO VOLT POWER-ON COMMAND

Primarily of value when interfacing the Minimoog Model D with other analog synthesizers, this command allows you to specify which note will cause the **PITCH OUT** control voltage (Pitch CV) to have a value of zero volts. The default setting causes the Pitch CV to be 1.00 volt when the C above low F on the keyboard is played. This key corresponds to MIDI note 48, meaning that MIDI note 36 will produce a Pitch CV value of zero volts. To specify a different note, hold A3 and press any one key in the octave above or below Middle C on the keyboard.

***NOTE:** This setting will affect both the Pitch CV output and the tuning of the synth itself, since the same voltage driving the oscillators appears at the Pitch CV output jack. Note that if you move “which key outputs zero volts” to a higher note on the keyboard, then the pitch that you hear when you play the same key will be transposed down by the same number of notes.*

MINIMOOG MODEL D OSCILLATOR TUNING PROCEDURE

From time to time the analog circuitry in your Minimoog Model D may require tuning to ensure peak performance. This tuning procedure should only be performed by a qualified technician. Please follow the procedure carefully and complete each step before advancing to the next step.

WARNING: Before tuning your Minimoog Model D, you **MUST** perform the Global Reset procedure as described on page 22 of this manual or calibration may fail.

To begin the tuning procedure, set the front panel rotary controls to the following positions:

- | | |
|----------------------------------|----------------------------------|
| TUNE: Centered | OSC 3 OCTAVE: 8' |
| GLIDE: Fully CCW | OSC 3 TUNE: Centered |
| MODULATION MIX: Fully CCW | OSC 3 WAVEFORM: Sawtooth |
| OSC 1 OCTAVE: 8' | OSC 1 VOLUME: 10 |
| OSC 1 WAVEFORM: Sawtooth | EXTERNAL SIGNAL VOLUME: 0 |
| OSC 2 OCTAVE: 8' | OSC 2 VOLUME: 10 |
| OSC 2 TUNE: Centered | NOISE VOLUME: 0 |
| OSC 2 WAVEFORM: Sawtooth | OSC 3 VOLUME: 10 |

Place the front panel switches in the following positions:

- OSC 3 CTRL:** ON (Up position)
- OSC 1 VOLUME:** ON
- EXTERNAL INPUT:** OFF
- OSC 2 VOLUME:** OFF
- NOISE VOLUME:** OFF
- OSC 3 VOLUME:** OFF

Place the LHC controls in following positions:

- PITCH WHEEL:** Centered
- MODULATION WHEEL:** Down
- GLIDE:** OFF
- DECAY:** OFF

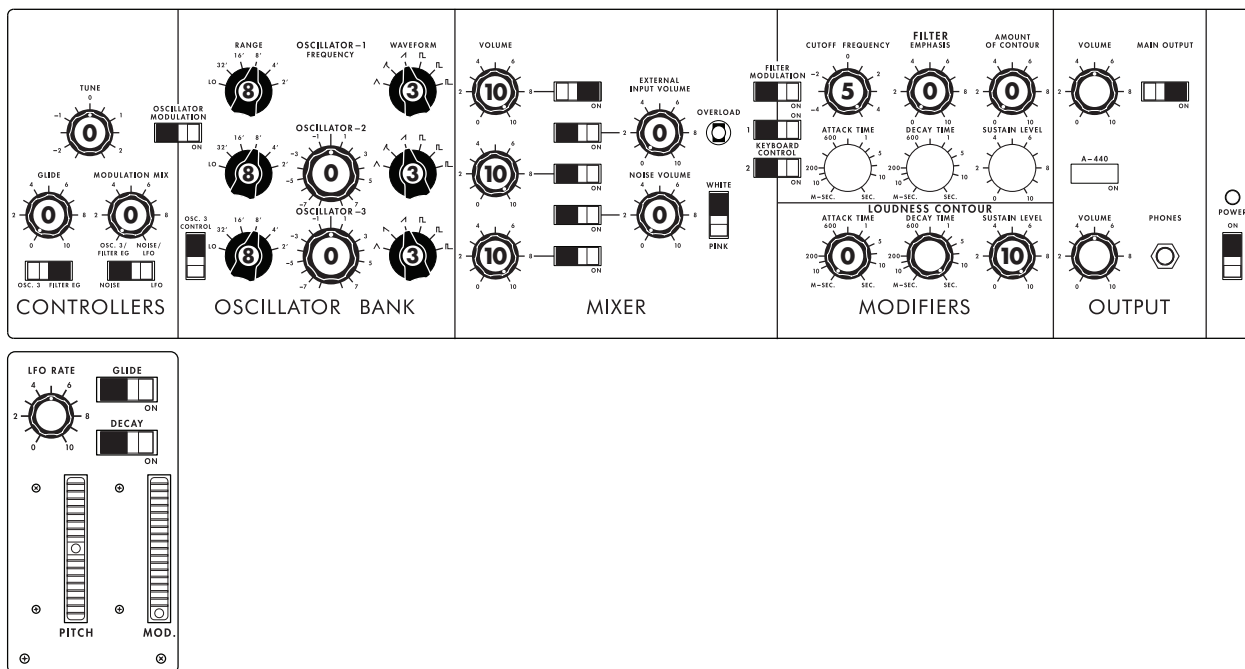

MINIMOOG MODEL D OSCILLATOR TUNING PROCEDURE (Continued)

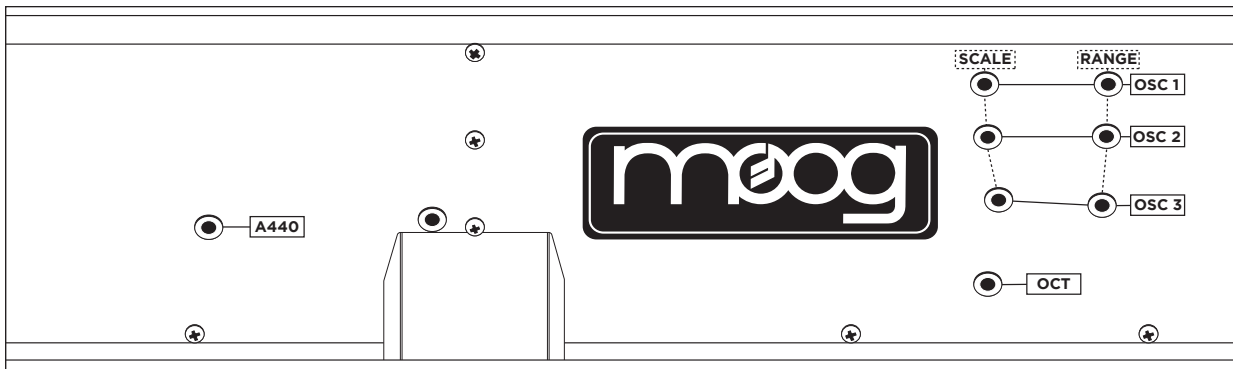

OSC 1 RANGE AND SCALE BOARD 1

NOTE: the following procedure uses headphones for the oscillator tuning. An audio amplification system can be used for this instead of the headphones.

NOTE: Periodically check the tuning of the A-440 tuner. If it is out of tune, simply use the A-440 trim pot to adjust it's tuning.

1. Set the **A-440** switch to the **ON** position.
2. Set the Filter **CUTOFF FREQUENCY** control to the maximum position.
3. Set the Filter **EMPHASIS** control to the minimum position.
4. Set the **LOUDNESS CONTOUR SUSTAIN LEVEL** and **DECAY TIME** controls to their maximum positions.
5. Depress the highest "A" key on the keyboard, and adjust the **OSC 1 RANGE** trimpot for zero beats.
6. Depress the lowest "A" on the keyboard, and adjust the **OSC 1 SCALE** trimpot for zero beats.
7. Repeat steps 6 and 7 above until there are zero beats against the A-440 tone. Note that this process may take several iterations.
8. Set the **A-440** switch to the **OFF** position, but keep **OSC 1** on.

OSC 2 RANGE AND SCALE BOARD 1

1. Set the **OSC 2 VOLUME** switch to the **ON** position.
2. Depress the highest "A" on the keyboard, and adjust the **OSC 2 RANGE** trimpot for zero beats to **OSC 1**.
3. Depress the lowest "A" on the keyboard, and adjust the **OSC 2 SCALE** trimpot for zero beats to **OSC 1**.
4. Repeat steps 2 and 3 above until there are zero beats from **OSC 2** to **OSC 1**.
5. Set the **OSC 2** audio switch to the **OFF** position.

OSC 3 RANGE AND SCALE BOARD 1

1. Set the **OSC 3 VOLUME** switch to the **ON** position.
2. Depress and hold the highest "A" on the keyboard, and adjust the **OSC 3 RANGE** trimpot for zero beats to **OSC 1**.
3. Depress and hold the lowest "A" on the keyboard, and adjust the **OSC 3 SCALE** trimpot for zero beats to **OSC 1**.
4. Repeat steps 2 and 3 above until there are zero beats from **OSC 3** to **OSC 1**.
5. Set the **OSC 3 VOLUME** switch to the **OFF** position.

OCT TRIM BOARD 1

1. Set the **OSCILLATOR-1 RANGE** rotary control to the **2'** position.
2. Set the **OSCILLATOR-2 RANGE** rotary control to the **2'** position.
3. Set the **OSCILLATOR-2 VOLUME** switch to the **ON** position.
4. Depress the highest "C" on the keyboard and hold.
5. Tune **OSCILLATOR-2** to **OSCILLATOR-1** with zero beats.
6. Set the **OSCILLATOR-1 RANGE** rotary switch to the **8'** position.
7. Adjust the OCT Trim trimpot for zero beats.
8. Repeat as needed until both oscillators are in tune with each other at any setting of the **RANGE** controls.

SPECIFICATIONS

SOUND SOURCES (5)

Oscillators x 3
Noise Generator
External Input

OSCILLATORS

Frequency Range: 0.1 to 20 kHz (In Six Overlapping Ranges)
Oscillator Stability (short term) > 0.25 %
Waveforms:

- Triangle
- Triangle-Sawtooth (Oscillator-1, Oscillator-2)
- Reverse Sawtooth (Oscillator-3)
- Sawtooth
- Rectangle
- Wide Pulse
- Narrow Pulse

NOISE GENERATOR

White
Pink

LFO

Rate: 0.05Hz to 200 Hz
Waveform: Triangle (knob down); Square (knob up)

EXTERNAL INPUT

Input Range: +10 millivolts to +2 volts
Input Impedance: 1MEG Ohms

FILTER

Filter Type: Voltage Controlled Low Pass (Moog Ladder Filter)
Cutoff Frequency Range: 10 Hz to 20 kHz
Filter Slope: 24 dB per Octave
Filter Resonance: At Cutoff Frequency

CONTOUR GENERATORS

Attack Time: 1 millisecond to 10 seconds
Decay Time: 4 milliseconds to >35 seconds
Sustain Level: 0 to 100% of Contour peak
Filter Contour Width: 0 to 4 Octaves

VOLTAGE CONTROLLED AMPLIFIERS (VCA)

Loudness Contour Dynamic Range: 80 dB

AUDIO INPUT LEVELS

1/4" External Signal Input
Voltage: +10 millivolts (min); +10 volt (max.)
Nominal Input Impedance: 1000K Ohms

SPECIFICATIONS *(Continued)*

AUDIO OUTPUT LEVELS

High Level Output

Typical Voltage: 0.5 volts

Maximum Voltage: 4.2 volts (peak-to-peak)

Nominal Output Impedance: 3K Ohms

Low Level Output (30 dB below High level)

Typical Voltage: 15 millivolts

Nominal Output Impedance: 1K Ohms

Headphone Output (stereo)

Maximum Voltage: 0.3 volts

Output Impedance: 8 Ohms

KEYBOARD

Key Action: Synthesizer (Spring)

Number of Keys: 44

Key Range: F0 to C4

Priority (Low, High, Last): User Selectable

Hardwired Connections:

Oscillator-1 (Pitch)

Oscillator-2 (Pitch)

Filter Contour (Trigger)

Loudness Contour (Trigger)

Switchable Connections:

Oscillator-3 (Pitch)

Filter (Keyboard Tracking 1/3)

Filter (Keyboard Tracking 2/3)

Typical Voltage: 0.5 volts

Maximum Voltage: 4.2 volts (peak-to-peak)

Nominal Output Impedance: 3K Ohms

Glide Rate (octave): 1 millisecond to 10 seconds

Pitch Bend Range: (+/-) 5 semitones (minimum)

CONTROL VOLTAGE OUTPUTS

After Pressure (aftertouch): 1/4" TS

0 to +5 volts with user adjustable trimpot

Pitch: 1/4" TS

-3 volts to +7 volts. C=0 volts

Gate: 1/4" TS

0 to +5 volts

Velocity: 1/4" TS

Selectable 0 to +5 volts or 0 to +10 volts with user adjustable trimpot

SPECIFICATIONS *(Continued)*

CONTROL VOLTAGE INPUTS

Loudness: 1/4" TRS

0 to +5 volts; +5 volts = Unity Gain

Ring connector allows pedal control via Moog EP-3 Expression Pedal

Filter (Cutoff Frequency): 1/4" TRS

1 volt per octave of change

Ring connector allows pedal control via Moog EP-3 Expression Pedal

Oscillators (Pitch): 1/4" TRS

1 volt per octave of change

Ring connector allows pedal control via Moog EP-3 Expression Pedal

Modulation Source: 1/4" TRS

Ring=Noise Send; Tip=Modulation Receive (This jack makes a normalised connection with no cable present.)

Trigger: +5 volt V-Trigger; 1/4" TS

Activates both Contour Generators

MIDI JACKS (5-PIN DIN STYLE)

MIDI In Note On (Trigger), Note #

MIDI Out Note On (Trigger); Note #
Pitch CV; Velocity; Aftertouch

MIDI Thru Mirror of the MIDI In signal

POWER SUPPLY

Self-switching external supply; 100-240 volts;
50/60 Hz; <12 Watt nominal consumption.

Locking XLR-4 connector.

DIMENSIONS (WITH PANEL FULLY LOWERED)

Width: 28.625" / 727 mm

Depth: 17.125" / 435 mm

Height: 5.75" / 146 mm

Net Weight: 32 lbs. / 14.5 kg.

TEMPERATURE

Storage Temperature: 5F to 140F (2C to 60C)

Nominal Operating Temperature: 10 - 35 C (50 - 95 F)

Operational Temperature: 10 - 50 C (50 - 122 F)

Specifications Subject To Change Without Notice

WARRANTY

Moog warrants its products to be free of defects in materials or workmanship and conforming to specifications at the time of shipment. The Warranty Period is one year from the date of purchase. If, in Moog's determination, it has been more than five years since the product shipped from our factory, Moog will determine whether or not to honor the warranty without regard to the date of the purchase. Your new product warranty is transferrable to a new user with a proof of purchase dated less than one year prior to the current date. To initiate a warranty transfer, email info@moogmusic.com with a copy of the original proof of purchase, the serial number, and your personal information and we will update the warranty status. During the Warranty Period, any defective products will be repaired or replaced, at Moog's option, on a return-to-factory basis. This warranty covers defects that Moog determines are no fault of the user.

The Moog Limited Warranty applies to USA purchasers only. Outside the USA the warranty policy and associated service is determined by the laws of the country of purchase and supported by our local authorized distributor. A listing of our authorized distributors is available on moogmusic.com.

If you purchase outside of your country, you can expect to be charged for warranty as well as non-warranty service by the service center in your country.

RETURNING YOUR PRODUCT TO MOOG MUSIC

You must obtain prior approval in the form of an RMA (Return Material Authorization) number from Moog before returning any product. Email techsupport@moogmusic.com for the RMA # via email or call us at (828) 251-0090. All products must be packed carefully and shipped with the Moog supplied power adapter. The Minimoog Model D must be returned in the original inner packing including the cardboard inserts. Sorry, the warranty will not be honored if the product is not properly packed. Once you have received the RMA# and carefully packed your Moog, ship the product to Moog Music Inc. with transportation and insurance charges paid, and include your return shipping address.

MOOG MUSIC
160 Broadway St.
Asheville NC, 28801

WHAT WE WILL DO

Once received, we will examine the product for any obvious signs of user abuse or damage as a result of transport. If the product abused, damaged in transit, or is out of warranty, we will contact you with an estimate of the repair cost. Warranty work will be performed and Moog will ship and insure your product to your United States address free of charge.

HOW TO INITIATE YOUR WARRANTY

Please initiate your warranty online at www.moogmusic.com/register. If you do not have web access, please call (828) 251-0090 to register your product.

CARING FOR THE MINIMOOG MODEL D

Clean the Minimoog Model D with a soft, dry cloth only – do not use solvents or abrasive detergents. Heed the safety warnings at the beginning of the manual. Don't drop the unit.

AN IMPORTANT NOTE ABOUT SAFETY: *There are no user serviceable parts in the Minimoog Model D. Refer all servicing to qualified personnel only.*

PATCH SHEETS

MIDNIGHT FUNK

CONTROLLERS

- TUNE: 0
- GLIDE: 1
- MODULATION MIX: 10
- OSC. 3 FILTER EG: [Slider]
- NOISE: [Slider]
- LFO: [Slider]
- OSCILLATOR MODULATION: [Slider]

OSCILLATOR BANK

- OSCILLATOR-1: RANGE 2, WAVEFORM 6
- OSCILLATOR-2: RANGE 16, WAVEFORM 0
- OSCILLATOR-3: RANGE 16, WAVEFORM 3

MIXER

- VOLUME: 5, 9, 10
- EXTERNAL INPUT VOLUME: 7
- NOISE VOLUME: 1.5
- OVERLOAD: [Switch]
- WHITE: [Slider]
- PINK: [Slider]

MODIFIERS

- CUTOFF FREQUENCY: -4
- FILTER EMPHASIS: 7
- AMOUNT OF CONTOUR: 6
- ATTACK TIME: 0
- DECAY TIME: 200
- SUSTAIN LEVEL: 4
- LOUDNESS CONTOUR: ATTACK TIME 0, DECAY TIME 800, SUSTAIN LEVEL 10

OUTPUT

- VOLUME: [Slider]
- MAIN OUTPUT: [Slider]
- A-440: [Slider]
- PHONES: [Slider]
- POWER: [Switch]

LFO RATE: 4

GLIDE: [Slider]

DECAY: [Slider]

PITCH: [Slider]

MOD.: [Slider]

NOTES

Adjust Filter Cutoff Frequency to taste.

AIR BASS

CONTROLLERS

- TUNE: 0
- GLIDE: 3
- MODULATION MIX: 0
- OSC. 3 FILTER EG: [Slider]
- NOISE: [Slider]
- LFO: [Slider]
- OSCILLATOR MODULATION: [Slider]

OSCILLATOR BANK

- OSCILLATOR-1: RANGE 32, WAVEFORM 3
- OSCILLATOR-2: RANGE 32, WAVEFORM 0
- OSCILLATOR-3: RANGE 16, WAVEFORM 6

MIXER

- VOLUME: 8, 2, 3
- EXTERNAL INPUT VOLUME: 0
- NOISE VOLUME: 1.5
- OVERLOAD: [Switch]
- WHITE: [Slider]
- PINK: [Slider]

MODIFIERS

- CUTOFF FREQUENCY: -3
- FILTER EMPHASIS: 3
- AMOUNT OF CONTOUR: 6
- ATTACK TIME: 0
- DECAY TIME: 100
- SUSTAIN LEVEL: 0
- LOUDNESS CONTOUR: ATTACK TIME 0, DECAY TIME 400, SUSTAIN LEVEL 10

OUTPUT

- VOLUME: [Slider]
- MAIN OUTPUT: [Slider]
- A-440: [Slider]
- PHONES: [Slider]
- POWER: [Switch]

LFO RATE: 4

GLIDE: [Slider]

DECAY: [Slider]

PITCH: [Slider]

MOD.: [Slider]

NOTES

SAWYER = BASS

CONTROLLERS

- TUNE: 0
- OSCILLATOR MODULATION: ON
- GLIDE: 0-8
- MODULATION MIX: 0-8
- OSC. 2 FILTER EG: 0-10
- NOISE: 0-10
- LFO: 0-10

OSCILLATOR BANK

- OSCILLATOR-1: RANGE (32), FREQUENCY (10)
- OSCILLATOR-2: RANGE (16), FREQUENCY (16)
- OSCILLATOR-3: RANGE (16), FREQUENCY (16)
- WAVEFORM: 3

MIXER

- VOLUME: 10, 10, 10
- EXTERNAL INPUT VOLUME: 9
- NOISE VOLUME: 0
- OVERLOAD: ON
- WHITE: ON
- PINK: ON

MODIFIERS

- CUTOFF FREQUENCY: -5
- ATTACK TIME: 0
- DECAY TIME: 5
- AMOUNT OF CONTOUR: 8
- SUSTAIN LEVEL: 0
- LOUDNESS CONTOUR: ATTACK TIME (0), DECAY TIME (5), SUSTAIN LEVEL (9)

OUTPUT

- VOLUME: 0-10
- MAIN OUTPUT: ON
- A-440: ON
- PHONES: ON
- POWER: ON

LFO RATE: 9

GLIDE: ON

DECAY: ON

PITCH: 0-10

MOD.: 0-10

NOTES

Adjust External Input Volume to taste.

KRAFT BASS

CONTROLLERS

- TUNE: 0
- OSCILLATOR MODULATION: ON
- GLIDE: 0-8
- MODULATION MIX: 10
- OSC. 2 FILTER EG: 0-10
- NOISE: 0-10
- LFO: 0-10

OSCILLATOR BANK

- OSCILLATOR-1: RANGE (32), FREQUENCY (10)
- OSCILLATOR-2: RANGE (32), FREQUENCY (10)
- OSCILLATOR-3: RANGE (16), FREQUENCY (16)
- WAVEFORM: 1

MIXER

- VOLUME: 10, 10, 10
- EXTERNAL INPUT VOLUME: 8
- NOISE VOLUME: 0
- OVERLOAD: ON
- WHITE: ON
- PINK: ON

MODIFIERS

- CUTOFF FREQUENCY: -3
- ATTACK TIME: 0
- DECAY TIME: 3M
- AMOUNT OF CONTOUR: 5
- SUSTAIN LEVEL: 0
- LOUDNESS CONTOUR: ATTACK TIME (0), DECAY TIME (400), SUSTAIN LEVEL (9)

OUTPUT

- VOLUME: 0-10
- MAIN OUTPUT: ON
- A-440: ON
- PHONES: ON
- POWER: ON

LFO RATE: 3

GLIDE: ON

DECAY: ON

PITCH: 0-10

MOD.: 0-10

NOTES

Adjust External Input Volume to taste.
Use Mod Wheel to introduce Vibrato.

DARK TOMS

<p>CONTROLLERS</p> <p>TUNE 0</p> <p>GLIDE 0</p> <p>MODULATION MIX 0</p> <p>OSC. 3/ FILTER EG 0</p> <p>NOISE 0</p> <p>LFO 0</p>	<p>OSCILLATOR BANK</p> <p>RANGE 32' 16' 8' 4'</p> <p>OSCILLATOR -1 FREQUENCY 32</p> <p>WAVEFORM 2</p> <p>OSCILLATOR -2</p> <p>OSCILLATOR -3</p> <p>OSC. 3 CONTROL</p>	<p>MIXER</p> <p>VOLUME 5</p> <p>EXTERNAL INPUT VOLUME 7</p> <p>NOISE VOLUME 2</p> <p>OVERLOAD</p> <p>WHITE</p> <p>PINK</p>	<p>MODIFIERS</p> <p>CUTOFF FREQUENCY -2</p> <p>FILTER EMPHASIS 0</p> <p>AMOUNT OF CONTOUR 4</p> <p>ATTACK TIME 0</p> <p>DECAY TIME 10M</p> <p>SUSTAIN LEVEL 0</p> <p>LOUDNESS CONTOUR</p> <p>ATTACK TIME 0</p> <p>DECAY TIME 600</p> <p>SUSTAIN LEVEL 0</p>	<p>OUTPUT</p> <p>VOLUME</p> <p>MAIN OUTPUT</p> <p>A-440</p> <p>PHONES</p> <p>POWER</p>
---	--	---	--	---

NOTES

LFO RATE

GLIDE ON

DECAY ON

PITCH

MOD.

VOCAL-BOT

<p>CONTROLLERS</p> <p>TUNE 0</p> <p>GLIDE 2</p> <p>MODULATION MIX 5</p> <p>OSC. 3/ FILTER EG 0</p> <p>NOISE 0</p> <p>LFO 0</p>	<p>OSCILLATOR BANK</p> <p>RANGE 32' 16' 8' 4'</p> <p>OSCILLATOR -1 FREQUENCY 32</p> <p>WAVEFORM 4</p> <p>OSCILLATOR -2</p> <p>OSCILLATOR -3</p> <p>OSC. 3 CONTROL</p>	<p>MIXER</p> <p>VOLUME 10</p> <p>EXTERNAL INPUT VOLUME</p> <p>NOISE VOLUME</p> <p>OVERLOAD</p> <p>WHITE</p> <p>PINK</p>	<p>MODIFIERS</p> <p>CUTOFF FREQUENCY -4</p> <p>FILTER EMPHASIS 8</p> <p>AMOUNT OF CONTOUR 1</p> <p>ATTACK TIME 0</p> <p>DECAY TIME 10M</p> <p>SUSTAIN LEVEL 0</p> <p>LOUDNESS CONTOUR</p> <p>ATTACK TIME 0</p> <p>DECAY TIME 800</p> <p>SUSTAIN LEVEL 5</p>	<p>OUTPUT</p> <p>VOLUME</p> <p>MAIN OUTPUT</p> <p>A-440</p> <p>PHONES</p> <p>POWER</p>
---	--	--	--	---

NOTES

LFO RATE

GLIDE ON

DECAY ON

PITCH

MOD.

VERY BAD PLACE

CONTROLLERS

- TUNE: 0
- OSCILLATOR MODULATION: ON
- GLIDE: 0
- MODULATION MIX: 5
- OSC. 2/ NOISE/ FILTER EG: 0
- OSC. 3/ FILTER EG: 0
- OSC. 3 CONTROL: 0

OSCILLATOR BANK

- OSCILLATOR-1 FREQUENCY: RANGE 10, 33, 16, 8, 4; WAVEFORM 4
- OSCILLATOR-2 FREQUENCY: RANGE 10, 33, 16, 8, 4; WAVEFORM 0
- OSCILLATOR-3 FREQUENCY: RANGE 10, 33, 16, 8, 4; WAVEFORM 0

MIXER

- VOLUME: 7, 4, 10
- EXTERNAL INPUT VOLUME: 0
- NOISE VOLUME: 5
- OVERLOAD: OFF
- WHITE: 0
- PINK: 0

MODIFIERS

- FILTER MODULATION: ON
- KEYBOARD CONTROL: 1
- CUTOFF FREQUENCY: -1
- ATTACK TIME: 0
- DECAY TIME: 400
- AMOUNT OF CONTOUR: 4
- SUSTAIN LEVEL: 0
- LOUDNESS CONTOUR: ATTACK TIME 0, DECAY TIME 3, SUSTAIN LEVEL 10

OUTPUT

- VOLUME: 0
- MAIN OUTPUT: ON
- A-440: ON
- VOLUME: 0
- PHONES: OFF
- POWER: ON

LFO RATE: 0

GLIDE: ON

DECAY: ON

PITCH: 0

MOD.: 0

NOTES

70's VIOLIN LEAD

CONTROLLERS

- TUNE: 0
- OSCILLATOR MODULATION: ON
- GLIDE: 2
- MODULATION MIX: 10
- OSC. 2/ NOISE/ FILTER EG: 0
- OSC. 3/ FILTER EG: 0
- OSC. 3 CONTROL: 0

OSCILLATOR BANK

- OSCILLATOR-1 FREQUENCY: RANGE 10, 33, 16, 8, 4; WAVEFORM 3
- OSCILLATOR-2 FREQUENCY: RANGE 10, 33, 16, 8, 4; WAVEFORM 4
- OSCILLATOR-3 FREQUENCY: RANGE 10, 33, 16, 8, 4; WAVEFORM 6

MIXER

- VOLUME: 5, 2
- EXTERNAL INPUT VOLUME: 0
- NOISE VOLUME: 0
- OVERLOAD: OFF
- WHITE: 0
- PINK: 0

MODIFIERS

- FILTER MODULATION: ON
- KEYBOARD CONTROL: 2
- CUTOFF FREQUENCY: 0
- ATTACK TIME: 10M
- DECAY TIME: 400
- AMOUNT OF CONTOUR: 3
- SUSTAIN LEVEL: 6
- LOUDNESS CONTOUR: ATTACK TIME 10M, DECAY TIME 1, SUSTAIN LEVEL 6

OUTPUT

- VOLUME: 0
- MAIN OUTPUT: ON
- A-440: ON
- VOLUME: 0
- PHONES: OFF
- POWER: ON

LFO RATE: 3

GLIDE: ON

DECAY: ON

PITCH: 0

MOD.: 0

NOTES

Use Mod Wheel to introduce Vibrato.

ROOM SNARE

CONTROLLERS

- TUNE: 0, -1, 1, -2, 2
- GLIDE: 0, 4, 6, 8, 10
- MODULATION MIX: 0, 2, 4, 6, 8
- OSC. 3 FILTER EG: 0, 10
- NOISE: 0, 10
- NOISE/LFO: 0, 10
- OSC. 3 CONTROL: 0, 10

OSCILLATOR BANK

- OSCILLATOR -1 FREQUENCY: RANGE (32', 16', 8', 4', 2'), WAVEFORM (A, FL, PL)
- OSCILLATOR -2: RANGE (32', 16', 8', 4', 2'), WAVEFORM (A, FL, PL)
- OSCILLATOR -3: RANGE (32', 16', 8', 4', 2'), WAVEFORM (A, FL, PL)

MIXER

- VOLUME: 0, 2, 4, 6, 8, 10
- EXTERNAL INPUT VOLUME: 0, 2, 4, 6, 8, 10
- NOISE VOLUME: 0, 2, 4, 6, 8, 10
- OVERLOAD: ON, OFF
- WHITE: 0, 10
- PINK: 0, 10

MODIFIERS

- CUTOFF FREQUENCY: 0, 2, 4, 6, 8, 10
- FILTER EMPHASIS: 0, 2, 4, 6, 8, 10
- AMOUNT OF CONTOUR: 0, 2, 4, 6, 8, 10
- ATTACK TIME: 0, 100, 200, 300, 400, 500, 600, 700, 800, 900, 1000
- DECAY TIME: 0, 10, 20, 30, 40, 50, 60, 70, 80, 90, 100
- SUSTAIN LEVEL: 0, 2, 4, 6, 8, 10
- LOUDNESS CONTOUR: ATTACK TIME (0-1000), DECAY TIME (0-100), SUSTAIN LEVEL (0-10)

OUTPUT

- VOLUME: 0, 2, 4, 6, 8, 10
- MAIN OUTPUT: ON, OFF
- A-440: ON, OFF
- PHONES: ON, OFF
- POWER: ON, OFF

NOTES

Play up and down the keyboard. Adjust Filter Decay and Cutoff Frequency. Use Mod Wheel to add modulation.

LFO RATE: 0, 2, 4, 6, 8, 10

GLIDE: ON, OFF

DECAY: ON, OFF

PITCH: 0, 10

MOD.: 0, 10

HI-HAT

CONTROLLERS

- TUNE: 0, -1, 1, -2, 2
- GLIDE: 0, 4, 6, 8, 10
- MODULATION MIX: 0, 2, 4, 6, 8
- OSC. 3 FILTER EG: 0, 10
- NOISE: 0, 10
- NOISE/LFO: 0, 10
- OSC. 3 CONTROL: 0, 10

OSCILLATOR BANK

- OSCILLATOR -1 FREQUENCY: RANGE (32', 16', 8', 4', 2'), WAVEFORM (A, FL, PL)
- OSCILLATOR -2: RANGE (32', 16', 8', 4', 2'), WAVEFORM (A, FL, PL)
- OSCILLATOR -3: RANGE (32', 16', 8', 4', 2'), WAVEFORM (A, FL, PL)

MIXER

- VOLUME: 0, 2, 4, 6, 8, 10
- EXTERNAL INPUT VOLUME: 0, 2, 4, 6, 8, 10
- NOISE VOLUME: 0, 2, 4, 6, 8, 10
- OVERLOAD: ON, OFF
- WHITE: 0, 10
- PINK: 0, 10

MODIFIERS

- CUTOFF FREQUENCY: 0, 2, 4, 6, 8, 10
- FILTER EMPHASIS: 0, 2, 4, 6, 8, 10
- AMOUNT OF CONTOUR: 0, 2, 4, 6, 8, 10
- ATTACK TIME: 0, 100, 200, 300, 400, 500, 600, 700, 800, 900, 1000
- DECAY TIME: 0, 10, 20, 30, 40, 50, 60, 70, 80, 90, 100
- SUSTAIN LEVEL: 0, 2, 4, 6, 8, 10
- LOUDNESS CONTOUR: ATTACK TIME (0-1000), DECAY TIME (0-100), SUSTAIN LEVEL (0-10)

OUTPUT

- VOLUME: 0, 2, 4, 6, 8, 10
- MAIN OUTPUT: ON, OFF
- A-440: ON, OFF
- PHONES: ON, OFF
- POWER: ON, OFF

NOTES

Adjust Loudness Decay Time to change behavior/hat tension.

LFO RATE: 0, 2, 4, 6, 8, 10

GLIDE: ON, OFF

DECAY: ON, OFF

PITCH: 0, 10

MOD.: 0, 10

DRONING BRASS INTRO

CONTROLLERS

- TUNE: 0
- OSCILLATOR MODULATION: ON
- GLIDE: 2
- MODULATION MIX: 10
- OSC. 3/ NOISE/ FILTER EG: 0
- NOISE: 0
- LFO: 0

OSCILLATOR BANK

- OSCILLATOR-1: RANGE 4, FREQUENCY 32'
- OSCILLATOR-2: RANGE 8, FREQUENCY 0
- OSCILLATOR-3: RANGE 8, FREQUENCY 0

MIXER

- VOLUME: 5, 2, 4
- EXTERNAL INPUT VOLUME: 0
- NOISE VOLUME: 0
- OVERLOAD: OFF
- WHITE: 0
- PINK: 0

MODIFIERS

- CUTOFF FREQUENCY: 1
- FILTER MODULATION: ON
- KEYBOARD CONTROL: 1
- ATTACK TIME: 10M
- DECAY TIME: 400
- FILTER EMPHASIS: 3
- AMOUNT OF CONTOUR: 2
- SUSTAIN LEVEL: 3
- LOUDNESS CONTOUR: ATTACK TIME 10M, DECAY TIME 1, SUSTAIN LEVEL 6

OUTPUT

- VOLUME: 0
- MAIN OUTPUT: ON
- A-440: ON
- VOLUME: 0
- PHONES: OFF
- POWER: ON

LFO RATE: 2

GLIDE: ON

DECAY: ON

PITCH

MOD.

NOTES

Turn Osc 2 Range to 32' for added depth.

BRIGHT & RUDE

CONTROLLERS

- TUNE: 0
- OSCILLATOR MODULATION: ON
- GLIDE: 0
- MODULATION MIX: 10
- OSC. 3/ NOISE/ FILTER EG: 0
- NOISE: 0
- LFO: 0

OSCILLATOR BANK

- OSCILLATOR-1: RANGE 8, FREQUENCY 3
- OSCILLATOR-2: RANGE 16, FREQUENCY 4
- OSCILLATOR-3: RANGE 32, FREQUENCY 6.5

MIXER

- VOLUME: 8, 8, 9
- EXTERNAL INPUT VOLUME: 0
- NOISE VOLUME: 0
- OVERLOAD: OFF
- WHITE: 0
- PINK: 0

MODIFIERS

- CUTOFF FREQUENCY: -3
- FILTER MODULATION: ON
- KEYBOARD CONTROL: 1
- ATTACK TIME: 10M
- DECAY TIME: 5
- FILTER EMPHASIS: 7
- AMOUNT OF CONTOUR: 6
- SUSTAIN LEVEL: 0
- LOUDNESS CONTOUR: ATTACK TIME 0, DECAY TIME 5, SUSTAIN LEVEL 10

OUTPUT

- VOLUME: 0
- MAIN OUTPUT: ON
- A-440: ON
- VOLUME: 0
- PHONES: OFF
- POWER: ON

LFO RATE: 3

GLIDE: ON

DECAY: ON

PITCH

MOD.

NOTES

Reduce Filter Emphasis for less rudeness.

STEEL WOUND

<p>CONTROLLERS</p> <p>TUNE 0</p> <p>GLIDE 0</p> <p>MODULATION MIX 0</p> <p>OSC. 3/ FILTER EG / NOISE / LFO</p>	<p>OSCILLATOR BANK</p> <p>OSCILLATOR -1 FREQUENCY: RANGE 32' 16' 8' 4' 2', WAVEFORM 6</p> <p>OSCILLATOR -2 FREQUENCY: RANGE 32' 16' 8' 4' 2', WAVEFORM 1</p> <p>OSCILLATOR -3 FREQUENCY: RANGE 32' 16' 8' 4' 2', WAVEFORM 1</p>	<p>MIXER</p> <p>VOLUME 4, 5, 4</p> <p>EXTERNAL INPUT VOLUME</p> <p>NOISE VOLUME 4</p> <p>OVERLOAD</p> <p>WHITE</p> <p>PINK</p>	<p>MODIFIERS</p> <p>CUTOFF FREQUENCY: FILTER MODULATION, KEYBOARD CONTROL</p> <p>FILTER EMPHASIS: 2</p> <p>AMOUNT OF CONTOUR: 6</p> <p>LOUDNESS CONTOUR: ATTACK TIME, DECAY TIME, SUSTAIN LEVEL</p>	<p>OUTPUT</p> <p>VOLUME MAIN OUTPUT</p> <p>A-440</p> <p>VOLUME PHONES</p> <p>POWER ON</p>
---	--	---	--	--

NOTES

LFO RATE 3

GLIDE ON

DECAY ON

PITCH

MOD.

FUZZ LEAD

<p>CONTROLLERS</p> <p>TUNE 0</p> <p>GLIDE 2</p> <p>MODULATION MIX 10</p> <p>OSC. 3/ FILTER EG / NOISE / LFO</p>	<p>OSCILLATOR BANK</p> <p>OSCILLATOR -1 FREQUENCY: RANGE 32' 16' 8' 4' 2', WAVEFORM 4</p> <p>OSCILLATOR -2 FREQUENCY: RANGE 32' 16' 8' 4' 2', WAVEFORM 3</p> <p>OSCILLATOR -3 FREQUENCY: RANGE 32' 16' 8' 4' 2', WAVEFORM 5</p>	<p>MIXER</p> <p>VOLUME 6, 7, 4</p> <p>EXTERNAL INPUT VOLUME</p> <p>NOISE VOLUME</p> <p>OVERLOAD</p> <p>WHITE</p> <p>PINK</p>	<p>MODIFIERS</p> <p>CUTOFF FREQUENCY: FILTER MODULATION, KEYBOARD CONTROL</p> <p>FILTER EMPHASIS: 2</p> <p>AMOUNT OF CONTOUR: 2</p> <p>LOUDNESS CONTOUR: ATTACK TIME, DECAY TIME, SUSTAIN LEVEL</p>	<p>OUTPUT</p> <p>VOLUME MAIN OUTPUT</p> <p>A-440</p> <p>VOLUME PHONES</p> <p>POWER ON</p>
--	--	---	--	--

NOTES

LFO RATE 3

GLIDE ON

DECAY ON

PITCH

MOD.

Use Mod Wheel to add Filter Modulation.

TRI KICK

CONTROLLERS

- TUNE: 0
- OSCILLATOR MODULATION: ON
- GLIDE: 0
- MODULATION MIX: 0
- OSC. 3/ NOISE/ FILTER EG: 0
- OSC. 3/ FILTER EG: 0
- NOISE: 0
- LFO: 0

OSCILLATOR BANK

- RANGE: 32
- OSCILLATOR-1 FREQUENCY: 0
- WAVEFORM: 1
- OSCILLATOR-2: 0
- OSCILLATOR-3: 0
- OSC. 3 CONTROL: 0

MIXER

- VOLUME: 10
- EXTERNAL INPUT VOLUME: 0
- NOISE VOLUME: 2
- OVERLOAD: OFF
- WHITE: 0
- PINK: 0

MODIFIERS

- FILTER MODULATION: ON
- KEYBOARD CONTROL: 1
- CUTOFF FREQUENCY: -0.5
- ATTACK TIME: 0
- DECAY TIME: 10M
- FILTER EMPHASIS: 0
- AMOUNT OF CONTOUR: 4
- SUSTAIN LEVEL: 0
- LOUDNESS CONTOUR: 0
- ATTACK TIME: 0
- DECAY TIME: 600
- SUSTAIN LEVEL: 0

OUTPUT

- VOLUME: 0
- MAIN OUTPUT: ON
- A-440: ON
- VOLUME: 0
- PHONES: OFF
- POWER: ON

LFO RATE: 0

GLIDE: ON

DECAY: ON

PITCH: 0

MOD.: 0

NOTES

Increase Amount Of Contour to add punch.

ABANDONED PLANET

CONTROLLERS

- TUNE: 0
- OSCILLATOR MODULATION: ON
- GLIDE: 2
- MODULATION MIX: 0
- OSC. 3/ NOISE/ FILTER EG: 0
- OSC. 3/ FILTER EG: 0
- NOISE: 0
- LFO: 0

OSCILLATOR BANK

- RANGE: 10
- OSCILLATOR-1 FREQUENCY: 10
- WAVEFORM: 4
- OSCILLATOR-2: 2
- OSCILLATOR-3: 0
- OSC. 3 CONTROL: 2

MIXER

- VOLUME: 8
- EXTERNAL INPUT VOLUME: 0
- NOISE VOLUME: 10
- OVERLOAD: OFF
- WHITE: 0
- PINK: 0

MODIFIERS

- FILTER MODULATION: ON
- KEYBOARD CONTROL: 1
- CUTOFF FREQUENCY: -4.5
- ATTACK TIME: 0
- DECAY TIME: 650
- FILTER EMPHASIS: 5
- AMOUNT OF CONTOUR: 2.5
- SUSTAIN LEVEL: 0
- LOUDNESS CONTOUR: 10M
- ATTACK TIME: 10M
- DECAY TIME: 10
- SUSTAIN LEVEL: 10

OUTPUT

- VOLUME: 0
- MAIN OUTPUT: ON
- A-440: ON
- VOLUME: 0
- PHONES: OFF
- POWER: ON

LFO RATE: 0

GLIDE: ON

DECAY: ON

PITCH: 0

MOD.: 0

NOTES

BUBBLE BASS

NOTES
Hold Notes. Pull down Mod Wheel for variation.

3-SQUARE LEAD

NOTES
Slightly detune Osc 2 & 3. Add Vibrato with Mod Wheel.

FREQY

CONTROLLERS

- TUNE: 0
- OSCILLATOR MODULATION: ON
- GLIDE: 4
- MODULATION MIX: 0
- OSC. 3/ NOISE/ FILTER EG: 0
- OSC. 3/ NOISE/ FILTER EG: 0

OSCILLATOR BANK

- RANGE: 32
- OSCILLATOR -1 FREQUENCY: 32
- WAVEFORM: 4
- OSCILLATOR -2: 16
- OSCILLATOR -2: 0
- OSCILLATOR -2: 4
- OSCILLATOR -3: 2
- OSCILLATOR -3: -4
- OSCILLATOR -3: 3
- OSC. 3 CONTROL: 0

MIXER

- VOLUME: 10
- EXTERNAL INPUT VOLUME: 0
- NOISE VOLUME: 0
- WHITE: 0
- PINK: 0

MODIFIERS

- CUTOFF FREQUENCY: -4
- FILTER EMPHASIS: 7
- AMOUNT OF CONTOUR: 9
- ATTACK TIME: 0
- DECAY TIME: 600
- SUSTAIN LEVEL: 2.5
- LOUDNESS CONTOUR: 0
- ATTACK TIME: 0
- DECAY TIME: 600
- SUSTAIN LEVEL: 7

OUTPUT

- VOLUME: 0
- MAIN OUTPUT: ON
- A-440: ON
- PHONES: 0
- POWER: ON

LFO RATE: 2

GLIDE: ON

DECAY: ON

PITCH

MOD.

NOTES

JURASSIC LOVE

CONTROLLERS

- TUNE: 0
- OSCILLATOR MODULATION: ON
- GLIDE: 5
- MODULATION MIX: 6
- OSC. 3/ NOISE/ FILTER EG: 0
- OSC. 3/ NOISE/ FILTER EG: 0

OSCILLATOR BANK

- RANGE: 16
- OSCILLATOR -1 FREQUENCY: 16
- WAVEFORM: 6
- OSCILLATOR -2: 16
- OSCILLATOR -2: 0
- OSCILLATOR -2: 6
- OSCILLATOR -3: 0
- OSCILLATOR -3: 4
- OSC. 3 CONTROL: 32

MIXER

- VOLUME: 7
- EXTERNAL INPUT VOLUME: 0
- NOISE VOLUME: 8
- WHITE: 0
- PINK: 0

MODIFIERS

- CUTOFF FREQUENCY: -5
- FILTER EMPHASIS: 5
- AMOUNT OF CONTOUR: 6
- ATTACK TIME: 0
- DECAY TIME: 10
- SUSTAIN LEVEL: 0
- LOUDNESS CONTOUR: 0
- ATTACK TIME: 0
- DECAY TIME: 5
- SUSTAIN LEVEL: 0

OUTPUT

- VOLUME: 0
- MAIN OUTPUT: ON
- A-440: ON
- PHONES: 0
- POWER: ON

LFO RATE: 2

GLIDE: ON

DECAY: ON

PITCH

MOD.

NOTES

TORNADUS

<p>CONTROLLERS</p> <p>TUNE 0</p> <p>GLIDE 2</p> <p>MODULATION MIX 6</p> <p>OSC. 3/ NOISE/ FILTER EG/ LFO</p>	<p>OSCILLATOR BANK</p> <p>RANGE 32' 16' 8' 4'</p> <p>OSCILLATOR -1 FREQUENCY 32</p> <p>OSCILLATOR -2 FREQUENCY 32</p> <p>OSCILLATOR -3 FREQUENCY 4.5</p> <p>WAVEFORM 1 3 2</p> <p>OSC. 3 CONTROL 4</p>	<p>MIXER</p> <p>VOLUME 10 8 7</p> <p>EXTERNAL INPUT VOLUME</p> <p>NOISE VOLUME 6</p> <p>OVERLOAD</p> <p>WHITE</p> <p>PINK</p>	<p>MODIFIERS</p> <p>CUTOFF FREQUENCY -3</p> <p>FILTER EMPHASIS 4</p> <p>AMOUNT OF CONTOUR 4.5</p> <p>ATTACK TIME 0</p> <p>DECAY TIME 600</p> <p>SUSTAIN LEVEL 4</p> <p>LOUDNESS CONTOUR</p> <p>ATTACK TIME 0</p> <p>DECAY TIME 400</p> <p>SUSTAIN LEVEL 6</p>	<p>OUTPUT</p> <p>VOLUME MAIN OUTPUT</p> <p>A-440</p> <p>VOLUME PHONES</p> <p>POWER ON</p>
---	---	--	--	--

NOTES

LFO RATE 3

GLIDE ON

DECAY ON

PITCH

MOD.

OCTAVE OUROBORUS

<p>CONTROLLERS</p> <p>TUNE 0</p> <p>GLIDE 0</p> <p>MODULATION MIX 6</p> <p>OSC. 3/ NOISE/ FILTER EG/ LFO</p>	<p>OSCILLATOR BANK</p> <p>RANGE 32' 16' 8' 4'</p> <p>OSCILLATOR -1 FREQUENCY 32</p> <p>OSCILLATOR -2 FREQUENCY 16</p> <p>OSCILLATOR -3 FREQUENCY 32</p> <p>WAVEFORM 6 5 1</p> <p>OSC. 3 CONTROL 4</p>	<p>MIXER</p> <p>VOLUME 8 6 6</p> <p>EXTERNAL INPUT VOLUME</p> <p>NOISE VOLUME 6</p> <p>OVERLOAD</p> <p>WHITE</p> <p>PINK</p>	<p>MODIFIERS</p> <p>CUTOFF FREQUENCY -2</p> <p>FILTER EMPHASIS 3</p> <p>AMOUNT OF CONTOUR 8</p> <p>ATTACK TIME 200</p> <p>DECAY TIME 1</p> <p>SUSTAIN LEVEL 10</p> <p>LOUDNESS CONTOUR</p> <p>ATTACK TIME 0</p> <p>DECAY TIME 5</p> <p>SUSTAIN LEVEL 10</p>	<p>OUTPUT</p> <p>VOLUME MAIN OUTPUT</p> <p>A-440</p> <p>VOLUME PHONES</p> <p>POWER ON</p>
---	--	---	--	--

NOTES

LFO RATE 3

GLIDE ON

DECAY ON

PITCH

MOD.

LIGHT CYCLE

CONTROLLERS

- TUNE: 0
- GLIDE: 0
- MODULATION MIX: 6
- OSC. 3/ NOISE/ FILTER EG/ LFO: 0
- OSC. 3 CONTROL: ON
- OSCILLATOR MODULATION: ON

OSCILLATOR BANK

- RANGE: 2
- OSCILLATOR -1 FREQUENCY: 16'
- WAVEFORM: 6
- OSCILLATOR -2: 16'
- OSCILLATOR -3: 16'

MIXER

- VOLUME: 4, 8
- EXTERNAL INPUT VOLUME: ON
- NOISE VOLUME: ON
- OVERLOAD: ON
- WHITE: ON
- PINK: ON

MODIFIERS

- CUTOFF FREQUENCY: -5
- FILTER EMPHASIS: 3
- AMOUNT OF CONTOUR: 8
- ATTACK TIME: 10
- DECAY TIME: 600
- SUSTAIN LEVEL: 10
- LOUDNESS CONTOUR: 0, 5, 10

OUTPUT

- VOLUME: 0
- MAIN OUTPUT: ON
- A-440: ON
- PHONES: ON
- POWER: ON

LFO RATE: 4

GLIDE: ON

DECAY: ON

PITCH

MOD.

NOTES

Experiment with the position of the modulation selection switches in the CONTROLLERS section.

MORE BOUNCE BASS

CONTROLLERS

- TUNE: 0
- GLIDE: 6
- MODULATION MIX: 0
- OSC. 3/ NOISE/ FILTER EG/ LFO: 0
- OSC. 3 CONTROL: ON
- OSCILLATOR MODULATION: ON

OSCILLATOR BANK

- RANGE: 32
- OSCILLATOR -1 FREQUENCY: 16'
- WAVEFORM: 3
- OSCILLATOR -2: 16'
- OSCILLATOR -3: 16'

MIXER

- VOLUME: 10, 10
- EXTERNAL INPUT VOLUME: ON
- NOISE VOLUME: ON
- OVERLOAD: ON
- WHITE: ON
- PINK: ON

MODIFIERS

- CUTOFF FREQUENCY: -4
- FILTER EMPHASIS: 6
- AMOUNT OF CONTOUR: 8
- ATTACK TIME: 500
- DECAY TIME: 10M
- SUSTAIN LEVEL: 2
- LOUDNESS CONTOUR: 0, 1, 10

OUTPUT

- VOLUME: 0
- MAIN OUTPUT: ON
- A-440: ON
- PHONES: ON
- POWER: ON

LFO RATE: 4

GLIDE: ON

DECAY: ON

PITCH

MOD.

NOTES

Mod Wheel controls Vibrato amount.

70's FRENCH SCI FI MOVIE

CONTROLLERS

- TUNE: 0
- GLIDE: 3
- MODULATION MIX: 0
- OSC. 3 FILTER EG: [Slider]
- NOISE: [Slider]
- LFO: [Slider]
- OSCILLATOR MODULATION: [ON/OFF]

OSCILLATOR BANK

- OSCILLATOR -1 FREQUENCY: 8
- OSCILLATOR -2: 16
- OSCILLATOR -3: 5
- RANGE: 32', 16', 8', 4', 2'
- WAVEFORM: 3, 2
- OSC. 3 CONTROL: [Slider]

MIXER

- VOLUME: 10, 10, [Slider]
- EXTERNAL INPUT VOLUME: [Slider]
- NOISE VOLUME: [Slider]
- WHITE: [Slider]
- PINK: [Slider]
- OVERLOAD: [ON/OFF]

MODIFIERS

- CUTOFF FREQUENCY: -3
- FILTER EMPHASIS: 6.5
- AMOUNT OF CONTOUR: 0
- ATTACK TIME: 0
- DECAY TIME: 800
- SUSTAIN LEVEL: 5
- LOUDNESS CONTOUR: 0, 800, 5
- KEYBOARD CONTROL: [ON/OFF]

OUTPUT

- VOLUME: [Slider]
- MAIN OUTPUT: [ON/OFF]
- A-440: [ON/OFF]
- PHONES: [ON/OFF]
- POWER: [ON/OFF]

LFO RATE: [Slider]

GLIDE: [ON/OFF]

DECAY: [ON/OFF]

PITCH: [Slider]

MOD.: [Slider]

NOTES

With Mod Wheel up, Osc 3 Frequency controls rate of “wobbly” modulated Filter.

CLASSIC STANLEY

CONTROLLERS

- TUNE: 0
- GLIDE: 5
- MODULATION MIX: 10
- OSC. 3 FILTER EG: [Slider]
- NOISE: [Slider]
- LFO: [Slider]
- OSCILLATOR MODULATION: [ON/OFF]

OSCILLATOR BANK

- OSCILLATOR -1 FREQUENCY: 4
- OSCILLATOR -2: 16
- OSCILLATOR -3: [Slider]
- RANGE: 32', 16', 8', 4', 2'
- WAVEFORM: 4, 1
- OSC. 3 CONTROL: [Slider]

MIXER

- VOLUME: 5, 3, [Slider]
- EXTERNAL INPUT VOLUME: [Slider]
- NOISE VOLUME: [Slider]
- WHITE: [Slider]
- PINK: [Slider]
- OVERLOAD: [ON/OFF]

MODIFIERS

- CUTOFF FREQUENCY: -3
- FILTER EMPHASIS: 6
- AMOUNT OF CONTOUR: 5
- ATTACK TIME: 5M
- DECAY TIME: 10M
- SUSTAIN LEVEL: 6
- LOUDNESS CONTOUR: 0, 600, 8
- KEYBOARD CONTROL: [ON/OFF]

OUTPUT

- VOLUME: [Slider]
- MAIN OUTPUT: [ON/OFF]
- A-440: [ON/OFF]
- PHONES: [ON/OFF]
- POWER: [ON/OFF]

LFO RATE: [Slider]

GLIDE: [ON/OFF]

DECAY: [ON/OFF]

PITCH: [Slider]

MOD.: [Slider]

NOTES

Use Mod Wheel for seasick Vibrato.

SUB BASS

CONTROLLERS

- TUNE: 0
- GLIDE: 0
- MODULATION MIX: 10
- OSC. 3/ NOISE/ FILTER EG: 0
- OSC. 3 CONTROL: ON
- OSCILLATOR MODULATION: ON

OSCILLATOR BANK

- OSCILLATOR -1: RANGE 32', 16', 8', 4', 2'; FREQUENCY 10; WAVEFORM 1
- OSCILLATOR -2: RANGE 32', 16', 8', 4', 2'; FREQUENCY 10; WAVEFORM 1
- OSCILLATOR -3: RANGE 32', 16', 8', 4', 2'; FREQUENCY 10; WAVEFORM 1
- OSC. 3 CONTROL: 10

MIXER

- VOLUME: 10
- EXTERNAL INPUT VOLUME: ON
- NOISE VOLUME: 0
- WHITE: ON
- PINK: ON

MODIFIERS

- CUTOFF FREQUENCY: 5
- FILTER EMPHASIS: 0
- AMOUNT OF CONTOUR: 0
- ATTACK TIME: 10
- DECAY TIME: 10
- SUSTAIN LEVEL: 10
- LOUDNESS CONTOUR: 0

OUTPUT

- VOLUME: 0
- MAIN OUTPUT: ON
- A-440: ON
- PHONES: ON
- POWER: ON

LFO RATE: 1

GLIDE: ON

DECAY: ON

PITCH

MOD.

NOTES

SYNC-STRIKE

CONTROLLERS

- TUNE: 0
- GLIDE: 1
- MODULATION MIX: 0
- OSC. 3/ NOISE/ FILTER EG: 0
- OSC. 3 CONTROL: ON
- OSCILLATOR MODULATION: ON

OSCILLATOR BANK

- OSCILLATOR -1: RANGE 4'; FREQUENCY 4; WAVEFORM 2
- OSCILLATOR -2: RANGE 4'; FREQUENCY 4; WAVEFORM 4
- OSCILLATOR -3: RANGE 32', 16', 8', 4', 2'; FREQUENCY 0; WAVEFORM 0
- OSC. 3 CONTROL: 32'

MIXER

- VOLUME: 5
- EXTERNAL INPUT VOLUME: ON
- NOISE VOLUME: 3
- WHITE: ON
- PINK: ON

MODIFIERS

- CUTOFF FREQUENCY: -3
- FILTER EMPHASIS: 0
- AMOUNT OF CONTOUR: 10
- ATTACK TIME: 10
- DECAY TIME: 300
- SUSTAIN LEVEL: 0
- LOUDNESS CONTOUR: 0

OUTPUT

- VOLUME: 0
- MAIN OUTPUT: ON
- A-440: ON
- PHONES: ON
- POWER: ON

LFO RATE: 1

GLIDE: ON

DECAY: ON

PITCH

MOD.

NOTES

Ensure Osc. 3 tuning is exact for proper performance.

NOTHIN' LEAD

<p>CONTROLLERS</p> <p>TUNE 0</p> <p>GLIDE 4.5</p> <p>MODULATION MIX 10</p> <p>OSC. 3 FILTER EG</p> <p>NOISE</p> <p>NOISE/FILTER LFO</p>	<p>OSCILLATOR BANK</p> <p>RANGE 32' 16' 8' 4'</p> <p>OSCILLATOR -1 FREQUENCY 2</p> <p>WAVEFORM 1</p> <p>OSCILLATOR -2</p> <p>OSCILLATOR -3</p> <p>OSC. 3 CONTROL</p>	<p>MIXER</p> <p>VOLUME 5</p> <p>EXTERNAL INPUT VOLUME</p> <p>NOISE VOLUME</p> <p>WHITE</p> <p>PINK</p>	<p>MODIFIERS</p> <p>CUTOFF FREQUENCY 0</p> <p>FILTER EMPHASIS 0</p> <p>AMOUNT OF CONTOUR 1</p> <p>ATTACK TIME 10M</p> <p>DECAY TIME 10M</p> <p>SUSTAIN LEVEL 0</p> <p>LOUDNESS CONTOUR</p> <p>ATTACK TIME 10M</p> <p>DECAY TIME 400</p> <p>SUSTAIN LEVEL 10</p>	<p>OUTPUT</p> <p>VOLUME</p> <p>MAIN OUTPUT</p> <p>A-440</p> <p>PHONES</p> <p>POWER</p>
--	---	---	--	---

LFO RATE 3

GLIDE

DECAY

PITCH

MOD.

NOTES
Mod Wheel adds Vibrato.

SMOOTH-E-P

<p>CONTROLLERS</p> <p>TUNE 0</p> <p>GLIDE 0</p> <p>MODULATION MIX 0</p> <p>OSC. 3 FILTER EG</p> <p>NOISE</p> <p>NOISE/FILTER LFO</p>	<p>OSCILLATOR BANK</p> <p>RANGE 32' 16' 8' 4'</p> <p>OSCILLATOR -1 FREQUENCY 4</p> <p>WAVEFORM 4</p> <p>OSCILLATOR -2</p> <p>OSCILLATOR -3</p> <p>OSC. 3 CONTROL</p>	<p>MIXER</p> <p>VOLUME 3</p> <p>EXTERNAL INPUT VOLUME</p> <p>NOISE VOLUME</p> <p>WHITE</p> <p>PINK</p>	<p>MODIFIERS</p> <p>CUTOFF FREQUENCY -1</p> <p>FILTER EMPHASIS 5</p> <p>AMOUNT OF CONTOUR 1</p> <p>ATTACK TIME 0</p> <p>DECAY TIME 10M</p> <p>SUSTAIN LEVEL 0</p> <p>LOUDNESS CONTOUR</p> <p>ATTACK TIME 0</p> <p>DECAY TIME 800</p> <p>SUSTAIN LEVEL 5</p>	<p>OUTPUT</p> <p>VOLUME</p> <p>MAIN OUTPUT</p> <p>A-440</p> <p>PHONES</p> <p>POWER</p>
---	---	---	--	---

LFO RATE 3

GLIDE

DECAY

PITCH

MOD.

NOTES

60'S SPACE

CONTROLLERS

- TUNE: 0
- OSCILLATOR MODULATION: ON
- GLIDE: 0
- MODULATION MIX: 0
- OSC. 3/ NOISE/ FILTER EG/ LFO: 0
- OSC. 3 FILTER EG: 0
- NOISE: 0

OSCILLATOR BANK

- OSCILLATOR -1 FREQUENCY: RANGE 8
- OSCILLATOR -2 FREQUENCY: 32
- OSCILLATOR -3 FREQUENCY: 5
- WAVEFORM: 1

MIXER

- VOLUME: 8
- EXTERNAL INPUT VOLUME: 0
- NOISE VOLUME: 0
- OVERLOAD: 0
- WHITE: 0
- PINK: 0

MODIFIERS

- FILTER MODULATION: ON
- KEYBOARD CONTROL: ON
- CUTOFF FREQUENCY: -3
- FILTER EMPHASIS: 5
- AMOUNT OF CONTOUR: 7
- ATTACK TIME: 5
- DECAY TIME: 1
- SUSTAIN LEVEL: 0
- LOUDNESS CONTOUR: ATTACK TIME 5M, DECAY TIME 3, SUSTAIN LEVEL 10

OUTPUT

- VOLUME: 0
- MAIN OUTPUT: ON
- A-440: ON
- PHONES: 0
- POWER: ON

LFO RATE: 0

GLIDE: ON

DECAY: ON

PITCH: 0

MOD.: 0

NOTES

Use Osc 3 Frequency Knob to adjust modulation rate.

SOFT REZ BASS

CONTROLLERS

- TUNE: 0
- OSCILLATOR MODULATION: ON
- GLIDE: 1
- MODULATION MIX: 0
- OSC. 3/ NOISE/ FILTER EG/ LFO: 0
- OSC. 3 FILTER EG: 0
- NOISE: 0

OSCILLATOR BANK

- OSCILLATOR -1 FREQUENCY: RANGE 16
- OSCILLATOR -2 FREQUENCY: 0
- OSCILLATOR -3 FREQUENCY: 0
- WAVEFORM: 1

MIXER

- VOLUME: 10
- EXTERNAL INPUT VOLUME: 0
- NOISE VOLUME: 0
- OVERLOAD: 0
- WHITE: 0
- PINK: 0

MODIFIERS

- FILTER MODULATION: ON
- KEYBOARD CONTROL: ON
- CUTOFF FREQUENCY: -3
- FILTER EMPHASIS: 5
- AMOUNT OF CONTOUR: 5
- ATTACK TIME: 0
- DECAY TIME: 200
- SUSTAIN LEVEL: 2
- LOUDNESS CONTOUR: ATTACK TIME 0, DECAY TIME 200, SUSTAIN LEVEL 10

OUTPUT

- VOLUME: 0
- MAIN OUTPUT: ON
- A-440: ON
- PHONES: 0
- POWER: ON

LFO RATE: 0

GLIDE: ON

DECAY: ON

PITCH: 0

MOD.: 0

NOTES

SINGING WIND

<p>CONTROLLERS</p> <p>TUNE: 0</p> <p>GLIDE: 0</p> <p>MODULATION MIX: 0</p> <p>OSC. 3/ FILTER EG: 0</p> <p>NOISE: 0</p> <p>LFO: 0</p>	<p>OSCILLATOR BANK</p> <p>OSCILLATOR -1 FREQUENCY: 32', 16', 8', 4', 2'</p> <p>OSCILLATOR -2: 32', 16', 8', 4', 2', -3, -5</p> <p>OSCILLATOR -3: 32', 16', 8', 4', 2', -3, -5</p>	<p>MIXER</p> <p>VOLUME: 2</p> <p>EXTERNAL INPUT VOLUME: 2</p> <p>NOISE VOLUME: 7</p> <p>WHITE: 0</p> <p>PINK: 0</p>	<p>MODIFIERS</p> <p>CUTOFF FREQUENCY: -2</p> <p>FILTER EMPHASIS: 7</p> <p>AMOUNT OF CONTOUR: 0</p> <p>ATTACK TIME: 0</p> <p>DECAY TIME: 0</p> <p>SUSTAIN LEVEL: 0</p> <p>LOUDNESS CONTOUR: 10M, 600, 3</p>	<p>OUTPUT</p> <p>VOLUME: 0</p> <p>A-440: 0</p> <p>PHONES: 0</p> <p>POWER: ON</p>
---	--	--	---	---

NOTES

LFO RATE: 2

GLIDE: ON

DECAY: ON

PITCH: 0

MOD.: 0

SONIC 7

<p>CONTROLLERS</p> <p>TUNE: 0</p> <p>GLIDE: 0</p> <p>MODULATION MIX: 10</p> <p>OSC. 3/ FILTER EG: 0</p> <p>NOISE: 0</p> <p>LFO: 0</p>	<p>OSCILLATOR BANK</p> <p>OSCILLATOR -1 FREQUENCY: 16</p> <p>OSCILLATOR -2: 32</p> <p>OSCILLATOR -3: 10</p> <p>WAVEFORM: 5, 4, 2</p>	<p>MIXER</p> <p>VOLUME: 10</p> <p>EXTERNAL INPUT VOLUME: 10</p> <p>NOISE VOLUME: 0</p> <p>WHITE: 0</p> <p>PINK: 0</p>	<p>MODIFIERS</p> <p>CUTOFF FREQUENCY: -2</p> <p>FILTER EMPHASIS: 7</p> <p>AMOUNT OF CONTOUR: 0</p> <p>ATTACK TIME: 0</p> <p>DECAY TIME: 0</p> <p>SUSTAIN LEVEL: 0</p> <p>LOUDNESS CONTOUR: 0, 800, 8</p>	<p>OUTPUT</p> <p>VOLUME: 0</p> <p>A-440: 0</p> <p>PHONES: 0</p> <p>POWER: ON</p>
--	---	--	---	---

NOTES

LFO RATE: 4

GLIDE: ON

DECAY: ON

PITCH: 0

MOD.: 0

Beefy Square wave bass with Mod Wheel down.
Crazy FX "ala Sonic 6" with Mod Wheel up.

DESTITUTION

The Destitution synthesizer control panel is divided into several sections:

- CONTROLLERS:** Includes a TUNE knob (0), GLIDE knob (0), MODULATION MIX knob (0), OSC. 3/ NOISE/ FILTER EG/ LFO selector, OSC. 3 CONTROL knob (0), and OSC. 3 FILTER EG/ NOISE/ LFO selector.
- OSCILLATOR BANK:** Features three oscillators (1, 2, 3) with RANGE, FREQUENCY, and WAVEFORM controls. Oscillator 1 is set to 8, 2 to 16, and 3 to 32.
- MIXER:** Contains three VOLUME knobs (8, 8, 0) and three ON/OFF switches for EXTERNAL INPUT VOLUME, NOISE VOLUME, and a color selector (WHITE/PINK).
- MODIFIERS:** Includes FILTER MODULATION, KEYBOARD CONTROL, CUTOFF FREQUENCY (-5), FILTER EMPHASIS (7), AMOUNT OF CONTOUR (5.5), ATTACK TIME (200), DECAY TIME (200), and SUSTAIN LEVEL (0) knobs.
- OUTPUT:** Features VOLUME, MAIN OUTPUT, A-440, PHONES, and POWER ON/OFF controls.

NOTES

LFO RATE knob is set to 4. GLIDE and DECAY are ON. PITCH and MOD. sliders are at their minimum positions.

NOTES

LOOKING GLASS ROCK

The Looking Glass Rock synthesizer control panel is divided into several sections:

- CONTROLLERS:** Includes a TUNE knob (0), GLIDE knob (0), MODULATION MIX knob (2), OSC. 3/ NOISE/ FILTER EG/ LFO selector, OSC. 3 CONTROL knob (0), and OSC. 3 FILTER EG/ NOISE/ LFO selector.
- OSCILLATOR BANK:** Features three oscillators (1, 2, 3) with RANGE, FREQUENCY, and WAVEFORM controls. Oscillator 1 is set to 16, 2 to 32, and 3 to 0.
- MIXER:** Contains three VOLUME knobs (5, 7, 9) and three ON/OFF switches for EXTERNAL INPUT VOLUME, NOISE VOLUME, and a color selector (WHITE/PINK).
- MODIFIERS:** Includes FILTER MODULATION, KEYBOARD CONTROL, CUTOFF FREQUENCY (-3), FILTER EMPHASIS (5), AMOUNT OF CONTOUR (7), ATTACK TIME (200), DECAY TIME (10), and SUSTAIN LEVEL (0) knobs.
- OUTPUT:** Features VOLUME, MAIN OUTPUT, A-440, PHONES, and POWER ON/OFF controls.

NOTES

LFO RATE knob is set to 3. GLIDE and DECAY are ON. PITCH and MOD. sliders are at their minimum positions.

NOTES

Try manipulating the Modulation Mix Control position.

REZ HIT

CONTROLLERS

- TUNE: 0
- GLIDE: 0
- MODULATION MIX: 0
- OSC. 3 FILTER EG: 0
- NOISE: 0
- NOISE/LFO: 0
- OSC. 3 CONTROL: 0
- OSCILLATOR MODULATION: ON

OSCILLATOR BANK

- OSCILLATOR-1 FREQUENCY: RANGE 32', 16', 8', 4', 2'; VALUE: 8
- OSCILLATOR-2: VALUE: 32
- OSCILLATOR-3: VALUE: 16
- WAVEFORM: OSCILLATOR-1: 5; OSCILLATOR-2: 2; OSCILLATOR-3: 4

MIXER

- VOLUME: 6, 6, 6
- EXTERNAL INPUT VOLUME: 0
- NOISE VOLUME: 0
- OVERLOAD: 0
- WHITE: 0
- PINK: 0

MODIFIERS

- CUTOFF FREQUENCY: -5
- FILTER EMPHASIS: 9
- AMOUNT OF CONTOUR: 3
- ATTACK TIME: 0
- DECAY TIME: 5M
- SUSTAIN LEVEL: 0
- LOUDNESS CONTOUR: ATTACK TIME: 0; DECAY TIME: 200; SUSTAIN LEVEL: 0

OUTPUT

- VOLUME: 0
- MAIN OUTPUT: ON
- A-440: ON
- PHONES: 0
- POWER: ON

LFO RATE: 0

GLIDE: ON

DECAY: ON

PITCH: 0

MOD.: 0

NOTES

Play with the Mod Wheel for varied effect.

SQUARE-MEOW

CONTROLLERS

- TUNE: 0
- GLIDE: 0
- MODULATION MIX: 10
- OSC. 3 FILTER EG: 0
- NOISE: 0
- NOISE/LFO: 0
- OSC. 3 CONTROL: 0
- OSCILLATOR MODULATION: ON

OSCILLATOR BANK

- OSCILLATOR-1 FREQUENCY: RANGE 32', 16', 8', 4', 2'; VALUE: 32
- OSCILLATOR-2: VALUE: 8
- OSCILLATOR-3: VALUE: 4
- WAVEFORM: OSCILLATOR-1: 4; OSCILLATOR-2: 5; OSCILLATOR-3: 6

MIXER

- VOLUME: 10, 10, 10
- EXTERNAL INPUT VOLUME: 0
- NOISE VOLUME: 0
- OVERLOAD: 0
- WHITE: 0
- PINK: 0

MODIFIERS

- CUTOFF FREQUENCY: -5
- FILTER EMPHASIS: 6
- AMOUNT OF CONTOUR: 8
- ATTACK TIME: 600
- DECAY TIME: 600
- SUSTAIN LEVEL: 4
- LOUDNESS CONTOUR: ATTACK TIME: 0; DECAY TIME: 600; SUSTAIN LEVEL: 7

OUTPUT

- VOLUME: 0
- MAIN OUTPUT: ON
- A-440: ON
- PHONES: 0
- POWER: ON

LFO RATE: 4

GLIDE: ON

DECAY: ON

PITCH: 0

MOD.: 0

NOTES

LEVEL-3

NOTES

THE HAUNTING

NOTES

THE JUMP

NOTES

BROKEN RADIO

NOTES

All Osc 3 controls, Filter Cutoff and Mod Wheel values can be changed or varied to create interesting effects. Having a long release time after striking notes allows both hands to change multiple knob values at once. Try changing Cutoff and Osc 3 Frequency simultaneously.

WEST COAST GHOST LEAD

CONTROLLERS

- TUNE: 0
- GLIDE: 7
- MODULATION MIX: 2
- OSC. 3/ NOISE/ FILTER EG/ LFO: 0
- OSC. 3 CONTROL: 10
- OSCILLATOR MODULATION: ON

OSCILLATOR BANK

- RANGE: 16' 8' 4'
- OSCILLATOR -1 FREQUENCY: 32' 16' 8' 4' 2'
- OSCILLATOR -2: 16' 8' 4' 2'
- OSCILLATOR -3: 16' 8' 4' 2'
- WAVEFORM: A, FL, FL
- OSC. 1: 3
- OSC. 2: 1
- OSC. 3: 1

MIXER

- VOLUME: 2, 4, 6, 8, 10
- EXTERNAL INPUT VOLUME: ON
- NOISE VOLUME: ON
- OVERLOAD: ON
- WHITE: ON
- PINK: ON

MODIFIERS

- CUTOFF FREQUENCY: -2.5
- FILTER EMPHASIS: 10
- AMOUNT OF CONTOUR: 0
- ATTACK TIME: 200
- DECAY TIME: 200
- SUSTAIN LEVEL: 2
- LOUDNESS CONTOUR: 0
- ATTACK TIME: 200
- DECAY TIME: 200
- SUSTAIN LEVEL: 8

OUTPUT

- VOLUME: 0, 5, 10
- MAIN OUTPUT: ON
- A-440: ON
- PHONES: ON
- POWER: ON

LFO RATE: 2, 4, 6, 8, 10

GLIDE: ON

DECAY: ON

PITCH: 0, 10

MOD.: 0, 10

NOTES

Using the A-440 Switch, press A2 on the Keyboard and tune the Cutoff Freq to A-440 (approx. 9 o'clock).

OUTLAW

CONTROLLERS

- TUNE: 0
- GLIDE: 0
- MODULATION MIX: 0
- OSC. 3/ NOISE/ FILTER EG/ LFO: 0
- OSC. 3 CONTROL: 16
- OSCILLATOR MODULATION: ON

OSCILLATOR BANK

- RANGE: 16' 8' 4'
- OSCILLATOR -1 FREQUENCY: 32' 16' 8' 4' 2'
- OSCILLATOR -2: 32'
- OSCILLATOR -3: 16' 8' 4' 2'
- WAVEFORM: A, FL, FL
- OSC. 1: 4
- OSC. 2: 0
- OSC. 3: 0

MIXER

- VOLUME: 5, 8, 10
- EXTERNAL INPUT VOLUME: ON
- NOISE VOLUME: ON
- OVERLOAD: ON
- WHITE: ON
- PINK: ON

MODIFIERS

- CUTOFF FREQUENCY: -5
- FILTER EMPHASIS: 0
- AMOUNT OF CONTOUR: 10
- ATTACK TIME: 0
- DECAY TIME: 200
- SUSTAIN LEVEL: 0
- LOUDNESS CONTOUR: 0
- ATTACK TIME: 0
- DECAY TIME: 1
- SUSTAIN LEVEL: 10

OUTPUT

- VOLUME: 0, 5, 10
- MAIN OUTPUT: ON
- A-440: ON
- PHONES: ON
- POWER: ON

LFO RATE: 2, 4, 6, 8, 10

GLIDE: ON

DECAY: ON

PITCH: 0, 10

MOD.: 0, 10

NOTES

Turn Osc 2 On/Off to introduce bass.

PRESET NAME:

CONTROLLERS

OSCILLATOR BANK

MIXER

MODIFIERS

OUTPUT

LFO RATE

GLIDE

DECAY

PITCH

MOD.

NOTES

PRESET NAME:

CONTROLLERS

OSCILLATOR BANK

MIXER

MODIFIERS

OUTPUT

LFO RATE

GLIDE

DECAY

PITCH

MOD.

NOTES

©2016 MOOG MUSIC INC. | 160 Broadway St. Asheville, NC 28801

Moog is a registered trademark of Moog Music Inc.

Minimoog is a registered trademark of Moog Music Inc.

The Moog Wordmark is a registered trademark of Moog Music Inc.

The Moog Icon is a registered trademark of Moog Music Inc.

All rights reserved to Moog Music Inc. on all text & graphics here within.

Phone: 828.251.0090

Email: info@moogmusic.com

Website: www.moogmusic.com

The Minimoog Model D Is Handcrafted With Care By Employee-Owners In Asheville, NC