

FillmoreTM 25

Owner's Manual

Hello from the Tone Farm

Congratulations on your choice of the FILLMORE™ and welcome to the MESA/Boogie® Family! The instrument you've selected has a deep heritage that combines the best attributes of vintage tube amplification with pioneering innovation that brings high-gain channel switching performance to a new frontier. One look at the thoroughness of the feature set of this amplifier tells you it's loaded with inspiring tools, but underneath the hood, the authenticity of these groundbreaking circuits and features (beware imitators) dates back to our MARK I™ and the very beginning of Modern guitar amplification. So congratulations on your choice... you should feel a sense of pride that you're playing an amp like no other, an original in every way! Just like you!

Our 45+ year commitment to excellence along with our solemn promise to musicians - to treat each of them as we ourselves would wish to be treated - guarantees you an experience that will make you feel truly justified in your choice. We're confident your new amplifier will have you smiling and inspired within minutes of plugging in for the first time...but what's really gratifying is that you will be finding new and inspiring sounds years after the price of admission has faded from memory and the FILLMORE™ continues to unveil it's true worth.

It's with our sincere thanks for trusting us with your TONE and our best wishes for all your musical endeavors that we welcome you home. Should you ever need assistance or guidance we're here to help. You now have in your hands an instrument of limitless expression. Our hope is that it takes you and your playing to new and unimagined places throughout your musical journey. From all of us here at MESA®...Enjoy!

Fillmore™ 25

Table of Contents

PRECAUTIONS	
OVERVIEW	1-3
GETTING STARTED	4
HELPFUL HINTS	5

FRONT PANEL

GAIN	5-6
TREBLE	6
MID	7
BASS	7-8
PRESENCE	8-9
MASTER	9
CHANNEL SELECT	9
MODE SELECT	9
POWER	9
STANDBY	9-10

REAR PANEL

AC MAINS SOCKET	10
FUSE	10
EFFECTS LOOP (SERIES)	10-11
REVERB FOOTSWITCH	11
REVERB	11-12
SPEAKER OUTPUTS	12
FACTORY SAMPLE SETTINGS	14-15
USER SETTINGS	16-17
TUBE TROUBLESHOOTING GUIDE	18-19
SPEAKER HOOKUP GUIDE	20-23
TUBE TASK CHART	24
PARTS LIST	25

IMPORTANT SAFETY INSTRUCTIONS

Read these instructions.

Keep these instructions.

Heed all warnings.

Follow all instructions.

Do not use this apparatus near water.

Clean only with dry cloth.

Do not block any ventilation openings. Install in accordance with the manufacturer's instructions.

Do not install near any heat sources such as radiators, heat registers, stoves, or other apparatus (including amplifiers) that produce heat.

Do not defeat the safety purpose of the polarized or grounding-type plug. A polarized plug has two blades with one wider than the other. A grounding type plug has two blades and a third grounding prong. The wide blade or the third prong are provided for your safety. If the provided plug does not fit into your outlet, consult an electrician for replacement of the obsolete outlet.

Protect the power cord from being walked on or pinched particularly at plugs, convenience receptacles, and the point where they exit from the apparatus.

Only use attachments/accessories specified by the manufacturer.

Unplug this apparatus during lightning storms or when unused for long periods of time.

Refer all servicing to qualified service personnel. Servicing is required when the apparatus has been damaged in any way, such as power-supply cord or plug is damaged, liquid has been spilled or objects have fallen into the apparatus, the apparatus has been exposed to rain or moisture, does not operate normally, or has been dropped.

To insure proper ventilation always make sure there is at minimum four inches (101.6mm) of space behind the rear of the apparatus. The ventilation should not be impeded by covering the ventilation openings with items, such as newspapers, tablecloths, curtains, etc. Do not impede ventilation by placing objects on top of the apparatus which extend past the rear edge of its cabinet.

No naked flame sources, such as lighted candles, should be placed on the apparatus.

The apparatus shall not be exposed to dripping or splashing and no objects filled with liquids, such as vases, shall be placed on the apparatus.

WARNING: To reduce the risk of fire or electric shock, do not expose this apparatus to rain or moisture.

The AC plug is the mains disconnect. The plug should remain accessible after installation.

WARNING: EU: permission from the Supply Authority is needed before connection.

WARNING: Always make sure proper load is connected before operating the amplifier. Failure to do so could pose a shock hazard and may result in damage to the amplifier.

Do not expose amplifier to direct sunlight or extremely high temperatures.

Always insure the amplifier is properly grounded. Always unplug AC power cord before changing fuse, tubes or removing chassis. Use only same type and rating when replacing fuse.

Avoid direct contact with heated tubes. Keep amplifier away from children.

To avoid damaging your speakers and other playback equipment, turn off the power of all related equipment before making the connections.

Do not use excessive force when handling buttons, switches and controls. Do not use solvents such as benzene or paint thinner to clean the unit.

Always connect to an AC power supply that meets the power supply specifications listed on the rear of the unit. Export models: always insure unit is wired for proper voltage. Make certain grounding conforms with local standards.

YOUR AMPLIFIER IS LOUD! EXPOSURE TO HIGH SOUND VOLUMES MAY CAUSE PERMANENT HEARING DAMAGE!

Your Mesa/Boogie Amplifier is a professional instrument. Please treat it with respect and operate it properly.

READ AND FOLLOW INSTRUCTIONS OF PROPER USAGE.

Fillmore™ 25

Operating Instructions

OVERVIEW

From the other branch of the Boogie® Family Tree comes this new vintage-voiced and styled amplifier featuring—soft clip to saturated—our most expressive cleans and transitional to medium gain ever presented.

To some this amplifier might seem a collection of contradictions: traditional looking and sounding cabinetry, yet loaded with a fully featured chassis sporting two identical Channels with 3 powerful Modes each. Basic circuit architecture paying homage to the best of the 1950s designs, yet modified, updated and hyper-tuned for present day needs and reliability. Hyper-tuned to accentuate the best of those classic sounds while also delivering higher gain performance rich with that spirit and character. Simplicity of operation that makes finding your voice near instantaneous and intuitive, yet offering versatility only found in much more feature-laden platforms. To us though, it's just an obvious natural step in the evolution of “classic” amplification.

The Fillmore™ is not just another Boogie...it's a new strand of Boogie DNA. Yet the molecules that make up this soulful sounding model are really just a revisiting of the Company's earliest roots. Randall Smith's very first Boogie's were based on this architecture. It was only the success of another “MARK I Experiment” featuring a different branch of the tree used by Carlos Santana on his “Ab-raxas” album that catapulted that sound and circuit and caused the shelving of circuitry the FILLMORE™ now resurrects with such beauty and authenticity.

Humbly named in tribute to the renown bi-coastal venues that showcased the biggest names in Classic Rock over decades, this new instrument has been dubbed super-responsive, nuanced, organic... and vintage-inspired magic by those who've experienced it. Subtle saturation that serves, not smothers, your style.

Don't wait a moment longer to discover what the MARK Series success inadvertently postponed for so long... you've already missed too many days and nights without inspiration like this. You can come back to this later and get some tips, but we purposefully made this amplifier the easiest ever wearing our moniker to navigate.

The FILLMORE™ was long Boogie's best-kept secret and has finally emerged and awaits your touch to ignite a new level of passion in your playing. We feel confident it'll take you there.

FRONT VIEW: FILLMORE™ 25

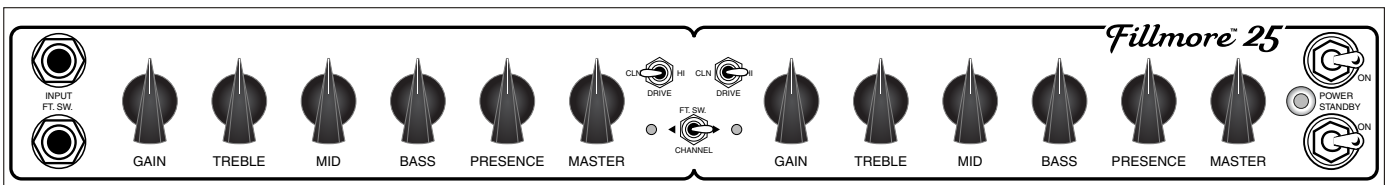

REAR VIEW: FILLMORE™ 25

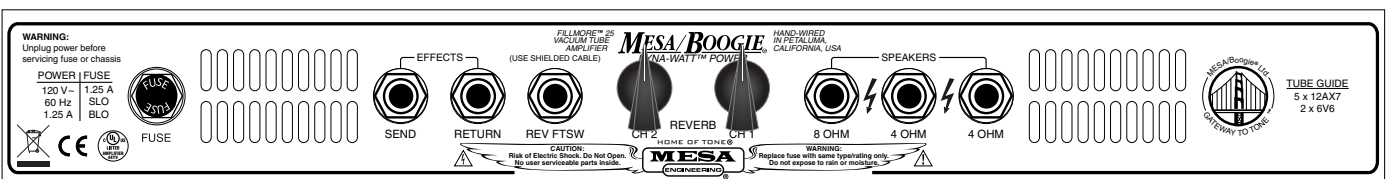

IDENTICAL CHANNELS

As you've noticed by now, the FILLMORE™ features two identical Channels. Three Modes aimed at covering all your needs, both clean and overdriven, are provided and virtually every sound imaginable can be found among them.

We've found over decades that most players, especially in the stylistic categories the FILLMORE™ aims at, tend to use either slight variations of the same gain structure or differing gain structures that are closely related sonically. The Fillmore's identical Channel platform offers the greatest flexibility in a 2-Channel Footswitchable format for the widest array of styles and players.

One player might use two Channels set to CLEAN and use one for pristine Chording and the other for pushed, soft-clip chording and single-note work, or perhaps a setting tailored for their favorite overdrive pedals. Another player might set up the classic clean and overdrive scenario using either of the gain Modes. Yet another might dial up a Crunch Rhythm sound in Channel 1 with DRIVE and a higher gain Lead voice with HI in Channel 2. Nearly limitless possibilities are supported with the Fillmore's identical Channel and Mode complement. It's up to you to explore them all and dedicate them to the sounds and switchable options that best suit your music, but best of all is that we've made it simple and intuitive to do so.

THE CHANNEL MODES

CLEAN

While the architecture of the Fillmore's preamp leans toward the more throaty voice and easier to clip "Tweed" circuits of the 1950s, we've managed to get the lower half of the CLEAN Mode to behave more like a 1960s circuit associated with the Blackface side of California's long-adored amplifier heritage. Below 1:00 on the GAIN control you'll find a wide range of beautiful clean sounds that have ample sparkle and chime to fall under the pristine clean umbrella.

Until the upper end of the CLEAN Mode's performance is explored for clipped sounds this trick might be taken for granted. However, when the region of authentic clipped sounds is taken into consideration as you approach 3:00 and beyond, it's no less than incredible the chameleon-like response this upper range delivers by comparison. All that crystalline sparkle gives way smoothly to a perfect top end that doesn't sound buzzy or thin when it's clipped and saturated. It's about as close as one can imagine to sustain without distortion—something we all dream about—or at least those of us who rely on sustain as an integral part of their solo voice.

The transition zone between these two different "personalities", 1:00-3:00, is where many will find the perfect "Clean" for relying on the instrument's volume control to add girth, push and color. This region also behaves really well with overdrive pedals, with enough top end to keep things open and sweet, but not so much that the overdrive applied from the pedals gets spike-y or adds buzz. This middle region possesses a nice blend of traits that works well with many different instruments, styles and external overdrive pedals. Though it is somewhat narrower than the truly clean zone below, or the more gain-rich region above, it nonetheless contains a usable gradient of low-end and top-end response that should be explored for these popular in-between sounds.

DRIVE

Speaking of "in-between", DRIVE is the quintessential model for this tricky and elusive world of not-quite-clean, but-not-overly-saturated guitar sounds. DRIVE picks up where the CLEAN Mode tops out (actually a little before) and goes almost up to "high gain" as can be found in the middle region of the HI Mode. However, unlike the rounder, warmer voice of HI, DRIVE features top end response more reminiscent of a clean channel or mode. This added or "unedited" top end allows the harmonics to come through and allows for a less compressed response that works extremely well with chordal work and single note soloing with a lot of dynamic content.

The DRIVE Mode, like CLEAN, contains more of this unfiltered harmonic content in the lower region of the GAIN Control's range, below 12:00. Beyond that, a more overdriven character becomes dominant and eventually, above 3:00, a more saturated sound is created. Unlike HI, this upper range still retains substantial top end and depending on application, the TREBLE, MID and PRESENCE become more important if you are looking for smooth single note soloing sounds. Each of these Tone Controls carries top end, including the MID, so you will need to experiment to find the right blend of each. This ratio is perhaps a little less critical for chordal work, but overall there is a fair amount of harmonics that expose themselves as the GAIN control is increased toward its maximum. This

is purposeful as it allows for overdriven chords to sound “open”, expressive and dynamically unhindered, as is needed for much of the Indy Rock and “Nashville Clean” styles. You will likely need to run the above three Tone Controls in their lower regions for smooth, singing, single note soloing.

HI HI delivers the highest gain of the three Modes in each Channel and like DRIVE, it features a wide range of saturation from subtle expressive clip to burning overdrive. The overlap between DRIVE and HI is found near its middle region and from there on up, HI begins to unleash more and more all-tube saturation until, at its maximum, it creates ample sustain, harmonics and compression for almost anything save for perhaps extreme modern metal sounds. Its whole purpose and sonic signature pays homage to the very best of the late 70s/early 80s Crunch Rhythm and Lead sounds used on so many records. It rides the line beautifully between those created by us at MESA/Boogie back in the day and those produced by the classic Brit amps popular in that era. Circuit-wise HI is all American, remaining closer to the wonderful tweed covered amps hailing from California in the 50s. We have taken our race shop approach and our usual “tuning”, though we refer to it as “Toning”, to create a veritable beast when things are dialed up past the 12:00 midway point on the GAIN control.

HI is also voiced a bit more rounded off on the top end and the harmonics are shaped to produce better single note response and a more voice-like character. This voicing excels at single-note soloing and allows a more vocal, pleasing tone for melody work. It can grind and growl as well, but you may find the TREBLE, MID and PRESENCE set a bit higher to get closer to the voicing of the DRIVE Mode. At times this may strike you at first listen as choked, rolled off or “not open” sounding, especially when coming from a sound you’ve created in the DRIVE Mode. This is likely an EQ Hangover, very familiar to us in our line of work. It often occurs when going from brighter sounds to warmer, darker ones. It also occurs with the midrange frequencies; a sound with very little mids present in the mix can make a sound with some midrange content intact sound “boxy” or “nasal”. Just give your ears a little time to adjust and you’ll discover that most sounds have their attributes and it’s all just a matter of recent reference and the application.

Some players find they can use HI as both a clean and overdrive sound simply by rolling up and down the instrument’s volume control. Depending on the guitar and how bright the pickups sound as the volume pot is rolled back, this is certainly a viable method of attaining both signatures. However, due to the less trimmed harmonics in the DRIVE Mode and depending on the amount of saturation you need for your optimal overdrive sound, you might find better results in the DRIVE Mode for this approach of using one Mode for your cover-all gain structure. Don’t forget. While this can, in effect, add an extra sound to your 2 Channel configuration here in the Fillmore, we did after all include a duplicate Channel so you wouldn’t have to sacrifice one beloved sound for another very often, if ever.

GETTING STARTED

1. After unpacking the amplifier, check to make sure all the tubes are firmly seated in their sockets as some may have loosened a bit during shipping.
2. Connect the A.C. Cord to a grounded (3 pin) A.C. outlet.
3. Unpack the footswitch and connect it using the mono cable provided to the FT. SW. jack on the far left of the Front Panel.
4. If you have purchased a Head Format, connect your speaker enclosure to the proper matching impedance SPEAKER OUTPUT on the Rear Panel, most typically to the 8 Ohm SPEAKER OUTPUT jack. An 8 Ohm load is preferable for your first experience with an amp this dynamic and explosive as you will hear the full power potential and best tonal balance. Combo amplifiers use an 8 Ohm internal speaker and it should already be connected to the proper impedance SPEAKER OUTPUT. If not, move the speaker cable to the 8 Ohm SPEAKER OUTPUT jack.
5. Flip the POWER Switch to the ON position while leaving the STANDBY Switch in the STANDBY position for at least 30 seconds. This allows the filaments to warm up in the tubes before being put to use. Following this cold-start procedure every time you power up will increase the toneful life of your tubes.
6. If you intend to connect processing devices to the EFFECTS LOOP, do so now. Look up EFFECTS LOOP in this manual for proper connection and operation. We recommend auditioning the Fillmore without processing for the first time, just to hear the pure sounds and get to know the amp by itself before adding processing. This also helps tell you if your processing might be robbing anything sonically from your new amplifier. If the Loop is to be used, check the INPUT levels on your processor to make sure they are in the medium to lower range so you can increase the level slowly once you have lifted STANDBY on the FILLMORE™ and run through the Channels to view the SEND level coming from the amp.

NOTE: Pedal type Processors don't always have an Input Level indicator, some have clip lights, and on either of these types you'll need to trust your ears regarding levels

7. Follow the Sample Settings examples below and set the Controls at these approximate settings for a tour through your new world of TONE. Remember these are just a glimpse at the vast possibilities and are meant to give you a taste of one possible way to set up your Channels. Feel free to fine tune the sound as you go...you can't hurt a thing and you will be learning by feel...the best way.
8. Flip the STANDBY to the ON position and enjoy the ride!

INSTANT GRATIFICATION In case you haven't yet played your new amplifier, below is just one example of the many ways to set up the Channels. This example demonstrates a pristine Clean sound in Channel 1 and a medium gain solo sound in Channel 2

Instant Gratification Settings

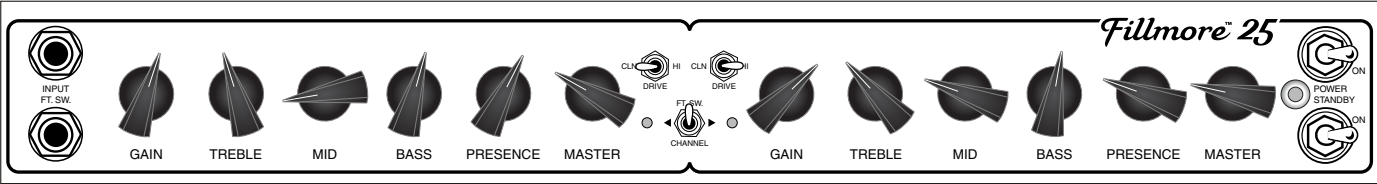

HELPFUL HINTS

NOTE: REDUNDANT INFORMATION: Throughout this Operating Guide you may encounter redundant information and sections that are repeated for your continued awareness and as reminders. This is done so a person can read only the sections they are interested in and yet still get the important points they should know or NEED to know about the FILLMORE™. We apologize if this gets annoying for the cover-to-cover reader, but even they may appreciate it some time in the future when referencing this Guide quickly for a specific topic.

- Beware of high settings on the BASS control in the DRIVE and HI modes, especially when the GAIN is set high. Too much BASS will produce a flubby, indistinct attack and “slow” the response time. A basic rule regarding the BASS control might be this; As the GAIN goes up...the BASS should come down.
- The GAIN and TREBLE Controls are the most powerful tone shaping controls in each Mode and should be used with taste. They determine much about the attack characteristic and the overall personality of the sound in all the Modes. Many of the great sounds found in all Modes will find these two Controls in their middle ranges.

NOTE: Avoid setting the TREBLE high (above 2:00) when the GAIN is to be set high as this brings about the tendency for a slightly microphonic tube to ring or squeal.

- Your amplifier will sound better and feel better to play if you have at least one speaker cabinet touching the floor you are standing on while you play. The coupling effect and especially the transmission of bass frequencies will cause the amp to sound fatter and the strings to feel more substantial and tangible when the amp (or cab) sits on the floor. Wood floors (like stages) are really great! Let's face it... the guitar can be one of those weird instruments that rarely feels the same way two days in a row, night to night, from room to room... and we can use all the help we can get. This usually helps... with the only exception being a stage filled with too many live mics...sometimes then you are forced to lift the amp to avoid the coupling effect.
- Use the STANDBY switch every time you power-up (from cold or hot), during set breaks, cable hook-ups and anytime you are not playing for a few minutes. Doing so will increase the toneful life of your tubes
- Circuits emanating from this “other side” of the MESA Line (as in non-MARK amplifiers) like your FILLMORE™ tend to favor TREBLE and PRESENCE control settings on the lower side for sounds in the warmer domain. Depending on guitar woods, pickups and technique, don't be surprised if you find great sounds below 12:00, or even all the way off on the TREBLE and PRESENCE, with the MID's broad Q that carries substantial top end providing all the top end cut you need.
- In the FILLMORE™, different and unique top end frequencies are found in the TREBLE, MID and PRESENCE controls. We suggest becoming familiar with what each of these powerful controls bring out or bury in the mix and learn to “swap the top” as you see fit for different styles, characters, responses and attack center-points. Spending a little time early on with these three powerful Tone and “dynamic” controls will allow you to dial up sounds quickly and easily and enhance your enjoyment of your amplifier.

FRONT PANEL

GAIN This is, by far, the most powerful control in the Tone Control string. Its setting determines the style and personality of the selected Mode(s). It meters the gain in different tube stages depending on the Mode and it sets Input Stage headroom, which determines whether the sound will be clean or overdriven. It also acts as a subtle Tone control as the tube stage's gain is increased or decreased and imparts its own “color” on the sound.

In all the Modes, there are three regions of the GAIN control; a low gain zone between 8:00 - 11:30, a warmer, more saturated zone from 11:00 - 2:00 and a higher gain zone from 2:30 – 5:00. Each of these zones can be used for many different applications and all can be used for both chording and single note solo work. As the GAIN control is swept throughout its range it imparts different textures and tonal characteristics.

Generally speaking, the lower end of the control (8:30 – 11:30) in both Channel's Modes produces a brighter, more open character that has more dynamic content available. This region is great for clean, sparkling chording in CLEAN, where the maximum headroom

is available, the top end harmonics are bubbly and the attack is fast. DRIVE and HI are tuned to deliver threshold sounds in this zone where the gain is more subtle, and there is still plenty of the guitar's personality intact. This zone is great for all the sounds when DRIVE and HI used for clipped chording, as there are plenty of dynamics intact that have not yet been compressed by too much saturation.

The middle region of the GAIN control (11:00 – 2:00) is where the most balanced sounds live and you will find this region delivers warm, full sound, detailed attack and good dynamics. CLEAN delivers great chording response, sounds richer and has more body here. Depending on pickup style and strength you will have to watch for clipping as you are nearing the crossover or threshold point gain-wise between clean and some saturation. Some of the most expressive best sounds possible in DRIVE and HI are to be found here, as things start smearing nicely as they transition into more and more tube overdrive. As you approach 12:00 in DRIVE and HI there will be plenty of saturation to push chords into clip and single notes hanging, but not so much as to start compressing the sound much.

The highest region of the GAIN control (2:00 – 5:00) is all about saturation, especially in DRIVE. Up here the signal gets much fatter in the low end and the top end begins to recede to create a rounder, more compressed sound. Dynamics become a little slower with lower peaks that are smoothed a bit and a more liquid feel is produced. In CLEAN the high end of the GAIN control produces some great pushed sounds as the Input stage gives it up and starts to saturate. This range of the GAIN control turns CLEAN into a viable and very expressive Mode for vintage-inspired single note Soloing. It also accommodates diode and tube based overdrive pedals nicely.

Both the DRIVE and HI Modes get wonderfully aggressive at the top-end of the GAIN control, unveiling their true potential for Crunch Rhythm and Rock oriented soloing. There is ample gain up here to rip into any style you wish, save for perhaps Modern Metal, pumping out thick stacked harmonic layers for chording and/or very expressive and nuanced overdrive for single notes.

At the highest GAIN settings you will notice the Tone controls have a slightly diminished effect on the sound. The notes are so saturated and their character has been pre-determined by the way each Channel is voiced and how it reacts to this level of gain. May we humbly suggest using the GAIN control no higher than you need it to achieve the style you want whenever possible in order reach the best balance of overdrive and still retain the most active shaping power of the Tone Controls. Also, your attack will remain more intact and definitive and not get over saturated and “slowed down”, which almost always leads to a more expressive and emotionally charged sound.

NOTE: TONE CONTROLS: *In the Fillmore, different and unique top-end frequencies are found in the TREBLE, MID and PRESENCE controls. We suggest becoming familiar with what each of these powerful controls bring out or bury in the mix and learn to “swap the top” as you see fit for different styles, characters, responses and attack center-points. Spending a little time early on with these three powerful Tone and “dynamic” controls will allow you to dial up sounds quickly and easily and enhance your enjoyment of your amplifier.*

TREBLE While the GAIN is the most powerful control, the TREBLE comes in a close second. The TREBLE is responsible for shaping the character of the entire Channel. It can overpower the rest of the Tone controls and therefore, its setting is crucial to a rich and balanced sound in all Modes. Setting the TREBLE with care and taste in mind is critical for achieving a blend and assuring the Tone control string works harmoniously.

In all three Modes the middle region of the TREBLE delivers the best balance and creates sounds that are plenty bright enough but still rich and warm. We suggest that you start with the TREBLE at 11:00 and adjust up or down slightly until the desired blend is achieved. However, circuits emanating from this “other side” of the MESA line and sharing that DNA tend to favor TREBLE and PRESENCE control settings on the lower side for sounds in the warmer domain. Depending on guitar woods, pickups and technique, don't be surprised if you find great sounds below 12:00, or even occasionally very low on the TREBLE and PRESENCE, with the MID's broad Q that carries substantial top end providing all the top-end cut you need.

In DRIVE and HI, the MID control carries frequencies that are somewhat close to the TREBLE along with the upper mid and lower mid frequencies it is centered around. Use this idiosyncrasy to your advantage and experiment with setting the TREBLE lower than “normal” and running the MID up a bit and vice versa. Some very cool sounds can be found with the TREBLE lower, even very low or “off” and the MID higher. Be sure to check this interaction between these two powerful controls, as it will be critical in achieving the sounds you hear in your head.

MID The MID control brings in and out a broad band of midrange frequencies and – as we have mentioned earlier in the TREBLE section – along with these rides a fair amount of higher “low treble” range frequencies. These highs are lower than that of the TREBLE, but they are important for the punch and cut of the amplifier in a mix.

For rhythm playing in the CLEAN Mode, but really globally in all the Channels, a lower MID setting (7:30–10:00) scoops some of this midrange attack and makes the bottom end breathe more while letting the higher harmonics define the top end, producing more sparkle, chime and openness. This range will also make things more resilient and create an easier to play, more elastic feel on the strings. Single coil guitars work very well here for the slinky, rubber-band attack and bouncy bass character associated with Blues, R&B, Country and most clean styles.

The middle region (10:00–1:00) is where the punch and attack begin to come on with more urgency and this is where mahogany guitars really like to see the MID set for adding the cut and definition. Here the top end begins to show itself in the mix of the MID controls' spectrum and chording sounds start to chime and slash with a more forward and very present character.

From there on up (1:00–5:30) the MID introduces an aggressive range of sounds that are still full, but quite forward as the dominant frequencies become those present under control of the MID. In this range you will likely have to increase the BASS to add back in the richness and warmth that gets overshadowed when the MID control is set high. If you like the attack and urgency found in this range of the MID, all the other controls (except maybe the MASTER, which you may have to back down as the sound gets more forward) may have to be set higher to keep up with the MID dominant curve. This is fine, although there will reach a point of diminishing return as the headroom in the preamp gets eaten up by this tonal arms race and you begin to clip the preamp with the high signal from the Tone control string.

For gain sounds in DRIVE and HI, a similar story unfolds as the MID is increased. Lower settings (7:30 – 10:30) will produce wider sounding, more elastic feeling chording sounds and the single notes will have a creamier, smoother character. High harmonics created by the gain and controlled largely with the TREBLE, will put a patina of three-dimensional, harmonic-enriched haze on things that smears nicely.

As the MID is increased past the 10:00 range, cut and bite begins to creep in along with a more chesty midrange punch. This is where some classic Crunch is found in the middle range of the GAIN control. This MID kick is an integral part of the impact and tight-tracking accuracy of this iconic medium-gain sound that has been a Rock staple for the last four decades. In both DRIVE and HI, the single notes leap forward with greater authority, speed.

Passing the 1:00 on the MID unleashes the brash attitude and top end joins the party. Here is where you look for the most forward and aggressive attack over a wider range than that of the TREBLE control. The feel on the strings will become less forgiving and your playing will be put under a microscope in the time domain. This region is great for pushing Rock rhythm sounds to the forefront of a mix. Single-note solo sounds will be fast, accurate and certainly will be heard by all. They will have a definite point of origin in the bar line.

One suggestion—or maybe more of a word of caution—the MID control contains frequencies that can be a little tough on the ears if not used with some discretion. Be sure to put your head down by the cabinet at some point and sample what you are dealing out to the audience and/or the microphone. You might be surprised how much impact—and possibly even unpleasantness—can be dialed in with higher settings of the MID. Unless you are out to hurt people, which is never a good idea, you may find the middle to lower range of the MID gives you plenty of attack and definition but still sounds balanced and warm and lets others enjoy your playing without wincing at every note.

BASS The BASS control blends in a fairly wide slice of rich bottom end to round out the sound. Internal switching that occurs when the different Modes are selected re-voices the frequency and amount of bass present for each circuit. This difference is crucial to the sounds and a big part of their character.

Clean incorporates a much lower bass frequency that adds depth, dimension and air to the sound. Both DRIVE and HI Modes utilize a higher frequency of bass that produces a more resonant, thumping quality and keeps things tighter and more bouncy with the added gain present in these two overdrive Modes. This frequency can be used in greater proportions as compared with the lower,

and possibly detrimental here, frequency used in the CLEAN mode. Therefore the need to be able to have different amounts of these two different frequencies is critical to both great sound and great footswitching compatibility between the Modes/Channels.

In the CLEAN mode, we like the balance of the BASS control when it is blending in warmth and body, but not overpowering the attack and sparkle in the mix. Depending on the setting of the GAIN control this can be different, as the lower GAIN settings can handle a little higher BASS settings. You will have to experiment with the exact settings. Below is a rough guideline example. But basically, if you follow this simple common sense approach—as GAIN goes up, BASS should come down—you'll find great sounds more easily.

Example:

- With the GAIN at 12:00 – BASS at 1:00
- With the GAIN at 1:00 – BASS at 12:00
- With the GAIN at 2:00 – BASS at 11:00

Again, this is just to give you a rough example of the concept. The offset differences might be greater than this or less, depending on guitar, speaker cabinet, room, live mics on stage, outdoors vs. indoors, etc.

The higher frequencies found in the BASS control in the DRIVE and HI modes are much more forgiving and can be used in higher amounts than the lower frequencies present in CLEAN. BASS settings between 12:00 and 3:00 will be commonplace with lower GAIN settings needing higher BASS settings and higher GAIN settings calling for more careful use of the BASS control. As the gain gets set lower and lower (GAIN 10:00 – 12:00) and things get tighter, there is a need for the rich low-end air that is created by the BASS control. When the gain saturates things as it's cranked up (GAIN 12:00 – 5:30), the notes thicken up and less bass is needed to create girth until - at a certain point - the bass frequencies start to slow things down and can even get in the way for some styles.

The great thing about the BASS control is that is the least affected by other controls and really the GAIN is the only control you will need to consider as far as avoiding less than optimum sounds. Unlike the TREBLE, MID and PRESENCE, which share the top end duties across a wide spectrum from really high midrange all the way to the harmonic region far above that the TREBLE affects, the BASS is a one stop shop in terms of dialing in rich low end.

PRESENCE

This control adjusts high frequencies above those of the TREBLE and is farther downstream in the signal path than the standard Tone Controls and located in the power section. You can think of the PRESENCE as a control that allows you to either clamp the highs down in the power amp, compressing and darkening things - or open it up and let the full spectrum of upper harmonics come chiming through. It also has a great deal to do with how dynamic the signal is and how a sound will cut through the mix in an ensemble environment.

At low settings (7:30 – 10:30) the sound will be warm and round with a more compressed feel and dynamic attack, especially in the upper frequencies that add urgency, will be limited. As the PRESENCE is increased (11:00 – 2:30), the top end starts to become more dominant and that compression gives way to “cut” and dynamic peaks jump out with startling speed and accuracy. At the top end of the control (2:30 – 5:30), a super aggressive blend of upper harmonics dominate the sound and this region can be somewhat dangerous if it's not applied in small measures. Higher notes will slice and dice even the bravest set of ears and we suggest using this region mostly in the studio for recording where the sound can be isolated and dealt with in context. Even then, it may find it's most appropriate applications on parts that feature the lower strings. This highest region – especially when coupled with the inherent curve of many of the microphones typically used in P.A. (sound reinforcement) applications, can be truly punishing in the wrong hands, so be cautious and courteous to your bandmates and audience and dial with care.

Clean sounds in Channel 1 can generally benefit from a bit higher settings (10:30 – 12:30) than sounds in this or any Channel that has overdrive involved in its makeup. Once saturation begins the frequencies carried in the PRESENCE control can make things edgy or brittle... even buzzy, real fast if you aren't careful. Overdriven chording sounds can tolerate higher settings (10:30 – 12:30) better than can single note sounds, which usually want to roam the zone below 11:00 to stay round, focused and vocal.

NOTE: As mentioned earlier, the entire top end spectrum is shared among the TREBLE, MID and PRESENCE, each having its own

region, power (effectiveness) and character in the overall signature of the top end. So when dialing in your sounds make sure to use all three of these controls to balance the different frequencies and amounts in your overall mix in each of the Modes.

MASTER This control determines the overall output level of each Mode/Channel and is located at the very end of the preamp. By using it in combination with the GAIN control, any amount of preamp signal strength – gain – (Within a Channel's parameters) can be achieved at any playing volume. Once you have dedicated the Channels to their respective sounds with the Mode Switch, you can then balance the volume levels of the Channels using the MASTER controls.

In addition to adjusting the playing loudness of the Channels, the MASTER, along with the setting of the GAIN control way upstream, functions as an EFFECTS SEND level control for the EFFECTS LOOP. The levels have been optimized at the SEND to accommodate the widest range of great usable sounds, so you will never likely know all the trouble we go to make sure not only do these three elements work seamlessly in tandem and protect the integrity of your Tone WITHOUT using the Loop, you can rest assured your processors will interface nicely with your FILLMORE™ without compromising the sound of it. However, please remember that EVERYTHING in the signal path is a “Tone element”, so keep that in mind when choosing processors to place right in the middle of your amplifier. Try to use processors of good quality that utilize good input and output circuitry as well as effects processor(s) or engines. For general applications and to get the best performance out of all the Modes we recommend MASTER settings in the 9:30 – 1:00 range with most great sounds producing adequate stage volumes around 10:00 – 12:00 on the MASTER.

Some purists like to run the MASTER all the way up and raise the GAIN until they reach their desired sound. The thinking there is that this scenario achieves the purest sound. In theory, they believe this resembles removing the control altogether from the signal path, and in a way it does. However, most all the “vintage non-master” amplifiers they are seeking to emulate have discrete resistors in that place in the circuit anyway to adjust or “tune” the output of the preamp to the power section sensitivity.

The MASTER is nothing more than a variable resistor(s) that offers an infinite range of settings possibilities and makes the amplifier many times more versatile with no sonic penalty. If you prescribe to this old school approach, then by all means, use the FILLMORE™ this way... it won't hurt the amplifier. However you will be severely limiting the potential sounds you can achieve by removing the limitless great sounding combinations of GAIN and MASTER settings.

CHANNEL SELECT This 3-Position mini toggle allows selection of the two Channels when the Footswitch is not in use. To use the Footswitch, select the Center FT. SW. position and select the desired Channel with the button on the Footswitch.

MODE SELECT Each Channel contains a MODE SELECT switch which allows selection of any one of the three preamp Modes (CLEAN, DRIVE and HI). The Channels are identical (except for any minor tolerance differences in the actual Pots, so you may dedicate your Channels as you see fit with no compromise or limitations.

POWER This switch controls the AC power Mains in your amplifier. Always make sure the (supplied) IEC Power Cable is connected to a grounded Outlet delivering the proper AC voltage – 117V USA. Never alter the Power Cable as doing so may cause damage to the amplifier, increase the risk of electric shock for you, and will void your Warranty. Always follow the Cold Start Procedure below and allow the tubes to warm up before turning the STANDBY on (switch up) as this will help the tubes and all other components in your amplifier to provide years of reliable service.

STANDBY This large toggle controls the high voltage to the power tubes and from cold start, helps minimize the inrush of current and reduces the “shock” on them, which ultimately helps increase their useful life. Just like a light bulb, much of the wear on tubes happens at the instant of power up. Minimizing this shock and allowing them to warm up more slowly ensures they will give you the longest life possible.

Before Power is switched on, make sure the amp is in STANDBY. Wait at least 30 seconds and then flip the STANDBY switch to the ON position. STANDBY is also very useful as a MUTE for either short interruptions – like changing instruments or patching cables as well as longer intervals such as Set Breaks or other extended periods. While you can leave the amplifier in STANDBY mode for hours

with no harm, it is probably wise to power down if you know you won't be playing for an hour or two. Why waste the electricity? Just remember to follow the Cold Start procedure mentioned above when you power back up, even if the amp is still "warm". The filaments in the tubes cool much more quickly than even the glass they are encased in, and they return to their "cold" state even after a short time with the power off. This procedure, when followed religiously, will help prevent tube problems and extend their useful life substantially.

COLD START PROCEDURE:

(Use every time amplifier has been switched off for more than 3 minutes)

1. Switch to STANDBY
2. Turn POWER to ON.
3. Wait AT LEAST 30 Seconds, preferably longer, for tubes to warm up.
4. Flip STANDBY to ON

NOTE: *This Cold Start Procedure is an important part of ensuring maximum tube life and reliability. Like a light bulb, the most wear occurs in the instant (short period, first few seconds) voltage is first applied. Like a light bulb, if a dimmer is used to reduce the voltage for the first few seconds or so of use, increased longevity is the result. The STANDBY is the amp's equivalent to a dimmer and using it in the above described method will ensure the longest life and best performance from a set of tubes (especially Output tubes).*

REAR PANEL

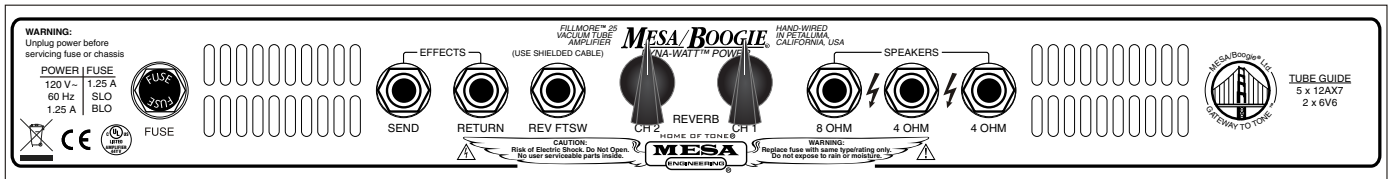

POWER OUTLET/AC MAINS SOCKET: (Removable IEC TYPE)

Underneath Rear Panel: This is the AC MAINS Power Cord Socket. The standardized removable power cable supplied with your amp can only be plugged in one way. Always connect the male end to a grounded (3-Hole) wall socket with the proper voltage present (117 Volts on U.S.A. Models). To Avoid The Risk Of Shock, Never Alter The Power Cable in any way. Altering the Power Cable will void your warranty and put you at risk while leaving your amplifier open to the possibility of damage.

FUSE

This is the A.C.'s (Alternating Current) main fuse and provides protection from outside A.C. fluctuations as well as power tube failure damage. Should the FUSE blow, replace it with the same rating in a Slo-Blo type package. The Domestic 117V version requires a 1.25 Amp Slo-Blo fuse. A power tube short or failure is often the cause of a blown fuse. Follow the cold start procedure mentioned in the STANDBY switch section and watch the power tubes as you flip the STANDBY to the ON position. If a power tube is going bad or is arcing, you will see it! Flip the STANDBY switch down immediately and replace the faulty power tube and the FUSE if necessary.

EFFECTS LOOP (SERIES)

These two 1/4" jacks provide the interfacing patch points for your "rear end" processing needs. The Effects Loop is basically a circuit bridge from the end of the preamp to the Driver stage, with the SEND interrupting the signal at the preamp's end and the RETURN feeding the power section just before the Driver tube.

Using this patch point usually ensures the best sonic performance as well as signal to noise ratio with your outboard processors. That said, it is important to point out that this is a critical junction in the Fillmore's circuit path and whatever is inserted here can have an effect on the overall performance of the amplifier.

The Effects Loop is a Series Loop, meaning that the entire signal goes through it, unlike a Parallel Loop where a percentage of the unaffected pure signal is taken around the Loop. Therefore, the quality of the devices used in the Loop and their performance is criti-

cal to achieving the best sound and performance from your amplifier. We recommend auditioning any processor with your amplifier BEFORE buying it to ensure it delivers a good match in performance. One clue is price. Like in any segment of the marketplace, you get what you pay for most times and there is a wide range of quality in regards to both build and sonic performance. While technology has raced ahead and features are at an all time pinnacle, it is the sound and feel for which you've likely chosen your pure analog all-tube amplifier. Therefore, we recommend a similar degree of discretion when it comes to choosing your processing devices. Ultimately, what you insert in the middle of your amplifier's signal path will have a lot to do with how it performs.

To connect your Processors:

1. Connect the SEND to your processor's INPUT
- 2 Connect the RETURN to your processor's OUTPUT.

Done.

It is always best to use the shortest cable lengths possible. If you intend to run very long cable lengths, use a buffer. Even though the amplifier's Effects Loop IS buffered, there can be some minimal sonic penalty the longer the cable length becomes.

Always use shielded, high quality cables to connect your processors to the Effects Loop.

One way to check the quality of your processors and also, match the levels, is this simple test:

Set up a sound without processors in the Loop. Listen to the sound and observe the feel.

Insert your processing into the Loop. Do the same.

Remove the SEND and RETURN cables from the Fillmore and if the sound gets better, or the level jumps up, you will know that either your processor's levels are too low, the quality is in question, or both. If unplugging the cables from your Effects Loop drops the signal level, simply reduce the Input or Output Levels of the processors. Repeat the test until there is no or very little difference in levels when the processors are inserted and removed again from the Effects Loop.

REVERB FOOTSWITCH

This 1/4" jack allows remote control of the Reverb via an optional Footswitch. You can obtain the Footswitch through your nearest MESA Dealer or from us directly. You may also use any standard "tip to ground" latching (not momentary) type Footswitch to control the Reverb. It's important to use a mono **shielded** cable to connect the footswitch to this jack. An unshielded cable creates a potential for noise.

REVERB

The FILLMORE™ uses an analog all-tube, spring Reverb circuit that produces lush, ambient Reverb effects from subtle to fully-drenched "Surf" levels that really enhance the Fillmore's vintage-inspired character. This control is the easiest to operate on the entire amp because what you hear is exactly what you get and, other than the physical interaction of volume and whatever harmonic resonances that might create, it is largely autonomous in nature and really shares no duties.

That said, much like the BASS, the more extreme the setting the GAIN control is, the more sensibly the Reverb should be applied. Luckily, this seems to follow the stylistic boundaries to a certain extent, in that most players who use extremely gained up sounds, tend to rely more on Delay than Reverb as their main form of adding a spatial quality to their sound.

However, in the clipped Clean domain things can often be different. In those circles, where clean amps cranked up produces the sound in favor, the sound of Reverb Tanks and their springs being overdriven, along with the analog circuitry feeding them, is an integral part of the authenticity and vibe. Feel free to utilize the CLEAN Mode for this application, crank the preamp's GAIN control and set the REVERB to your desired saturation level. Just remember that reverb is essentially a mechanical moving part at its core and therefore affected by physical elements such as vibration, both in the amp and externally, and also by certain frequencies, as everything that vibrates can potentially resonate with other things vibrating. The most clear example of this is Reverb set at very high levels "feeding

back” on certain notes. If you ever experience this phenomena, simply start reducing GAIN and Reverb levels, sometimes even the Tone Controls individually, until things stabilize and no longer want to feed back and take off.

SPEAKER OUTPUTS These are the Speaker Outputs to your cabinetry or in the case of a Combo, the Internal Speaker. As mentioned earlier, we prefer 8 Ohm Loads whenever possible for many reasons from sonic to adaptability with other speakers and feel your amplifier sounds its best with that impedance loading it.

When using the Combo by itself or the Head through a standard MESA 8 Ohm 4x12 or 1x12 Extension cabinet, use the 8 OHM jack. Most MESA 2x12 Cabinets are also wired to 8 Ohms and they can be used in this Output as well.

Adding a second 8 Ohm speaker or Cabinet we advise connecting each to a 4 Ohm Output. Current and recent MESA Cabinetry also provides a Parallel Jack that allows daisy-chaining and this configuration mimics connecting each 8 Ohm Speaker to a separate 4 Ohm Output. This will provide a better impedance match and ensure the full power and headroom is available.

A single 4 Ohm Cabinet should be used with the 4 OHM Output.

A 16 Ohm 4x12 Cabinet or 2x12 Cabinet should be used in the 8 OHM Output and will result in a slight reduction in maximum power, though it will likely be unnoticeable with the additional coverage four or even two speakers provides.

Two 16 Ohm Cabinets connected to the 8 OHM Output will produce a better impedance match and will offer the full power and headroom.

NOTE: *We do not recommend using two 4 Ohm cabinets as this will present a 2 Ohm load to the Output transformer and put undue strain on it as it was not designed for this application.*

Below for your reference are some common and correct SPEAKER Output Connection Examples:

- One 8 Ohm Cabinet – To 8 Ohm SPEAKER Output (One MESA 8 Ohm Cabinet).
- Two 8 Ohm Cabinets – Each to a separate 4 Ohm SPEAKER Output or... One Cabinet to PARALLEL Input on MESA Speaker Cabinet and 2nd Cabinet to other PARALLEL jack On MESA Cabinet.
- One 4 Ohm Cabinet – To 4 Ohm SPEAKER Output. (Any 4 Ohm Cabinet)
- Two 4 Ohm Cabinets – NOT RECOMMENDED! Output Transformer NOT setup to run on 2 Ohm Load.
- One 16 Ohm Cabinet – To 8 Ohm SPEAKER Output. (Slight reduction in maximum power)
- Two 16 Ohm Cabinets – Use Parallel Box or “Y” connector to 8 Ohm SPEAKER Output.

These common Cabinet connection scenarios will cover most of the widely used setups you will run into. There are likely others less common that we have not identified here, and some may also be safe and unique sounding. Feel free to call us if you are concerned as it is always better to be safe than sorry when it comes to ensuring proper loading of an expensive amplifier/piece of equipment like the Fillmore. Our Product Specialists will be happy to guide you and/or get you the proper information regarding this important topic.

We thank you for choosing us to be your amplifier company and we look forward to helping you derive many years of satisfaction from your new amplifier. Call us should you ever need assistance not provided here in this User Manual.

Again, Congratulations on your choice of the FILLMORE™ and welcome to the MESA/Boogie Worldwide Family!

REST AREA

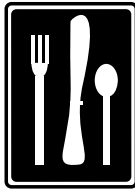
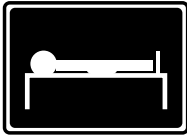

FACTORY SAMPLE SETTINGS

CLEAN

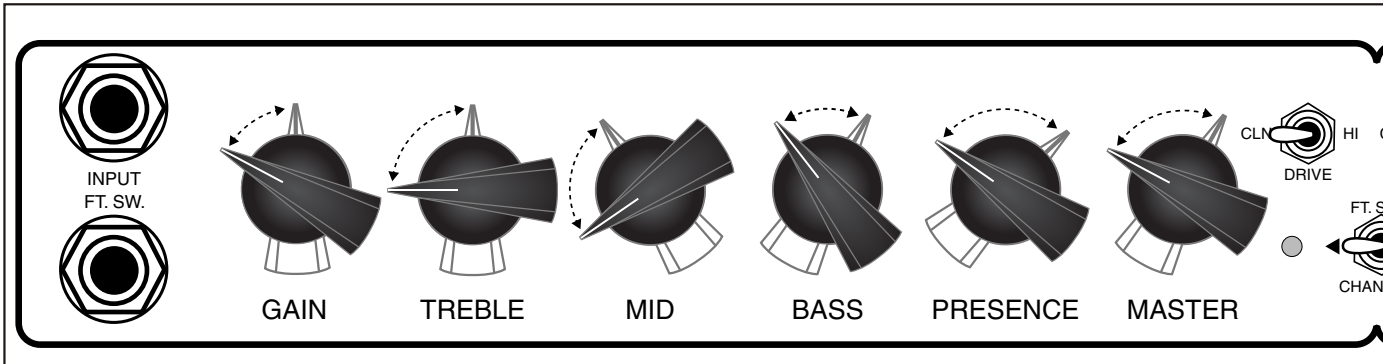

DRIVE

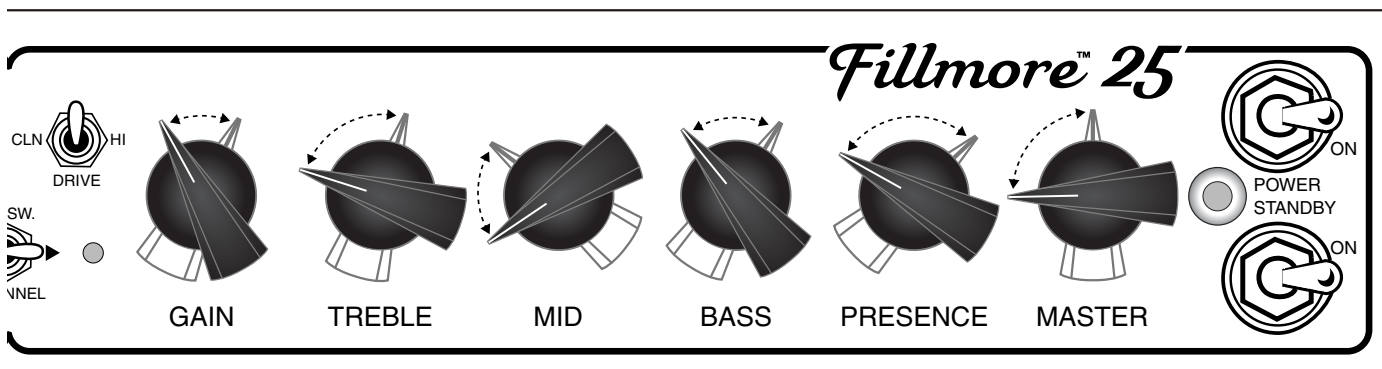

DRIVE CRUNCH

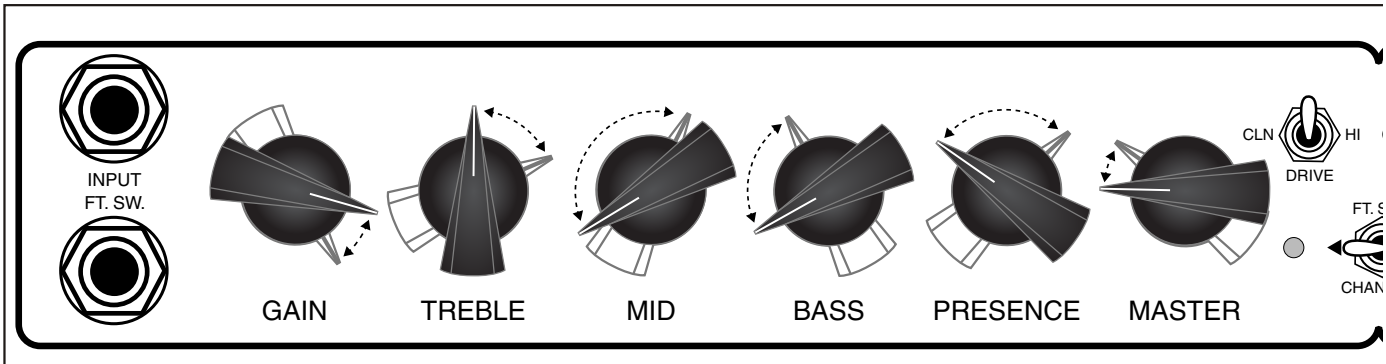

BURN

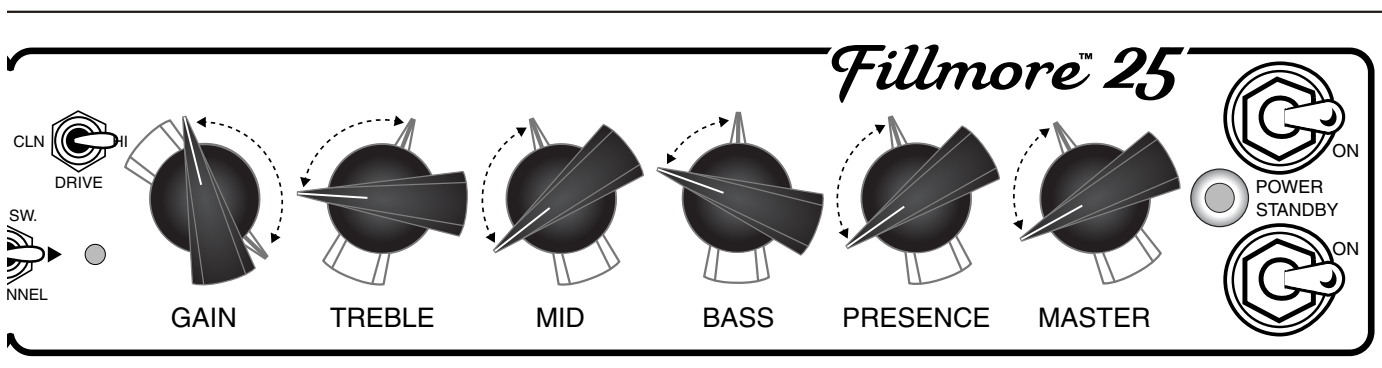

FACTORY SAMPLE SETTINGS

PUSHED CLEAN

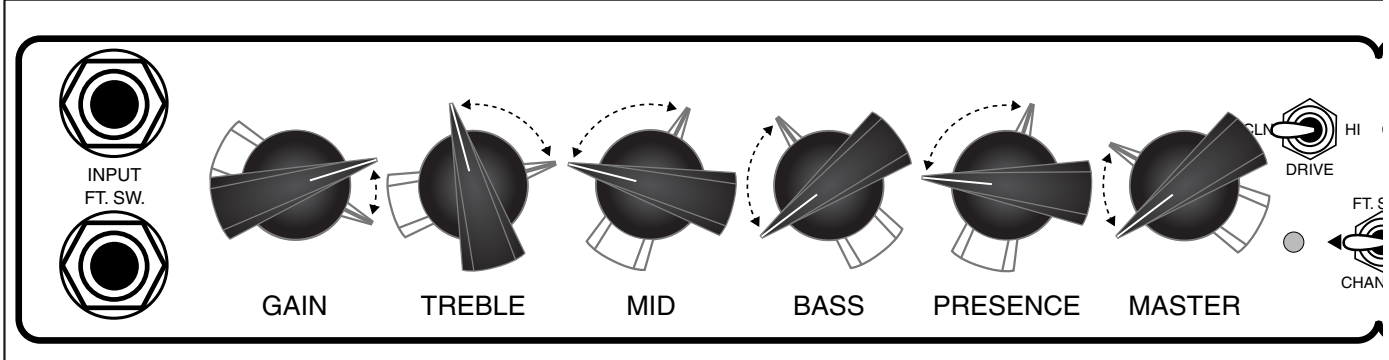

DRIVE SOLO

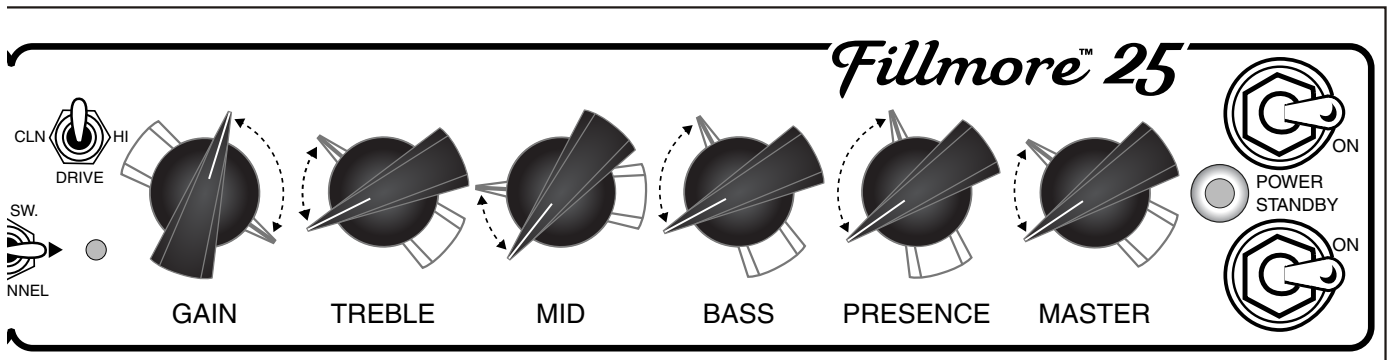

DRIVE "CLEAN"

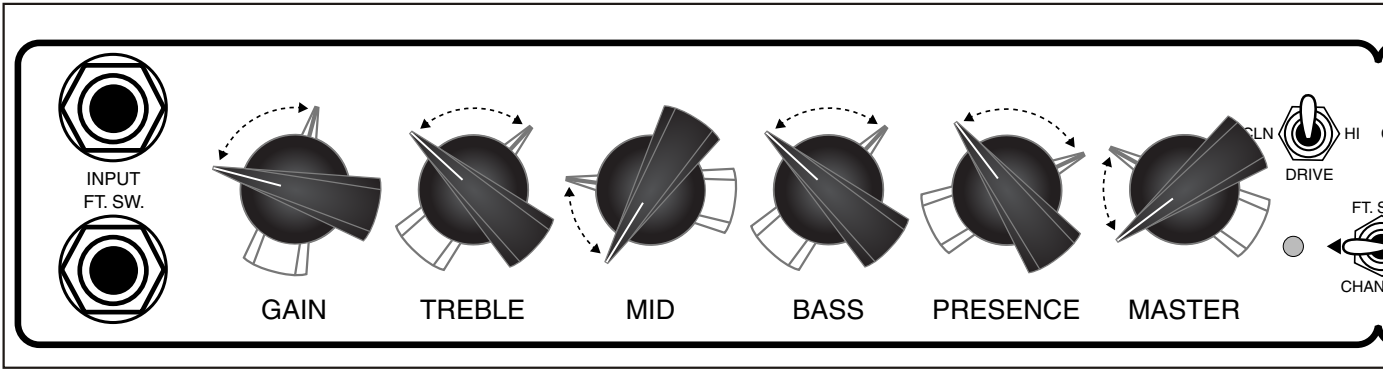

BLUES HI

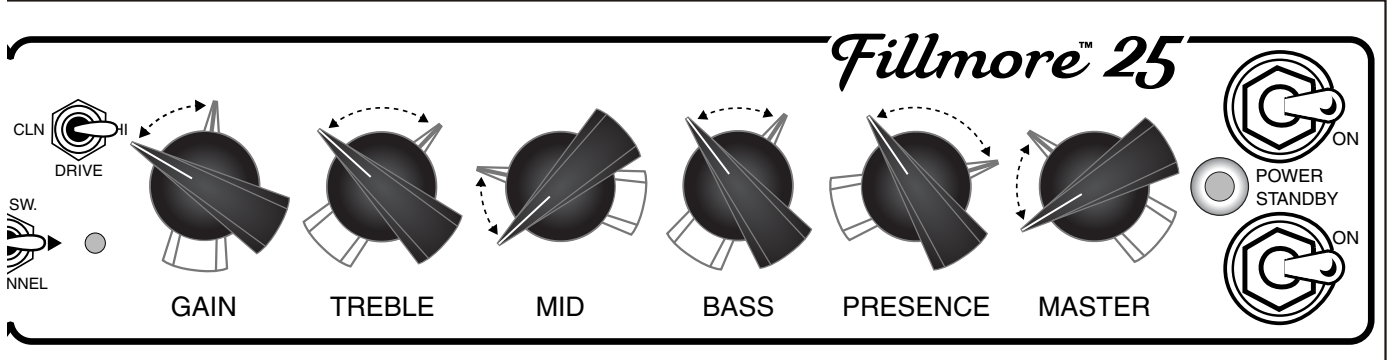

USER SETTINGS

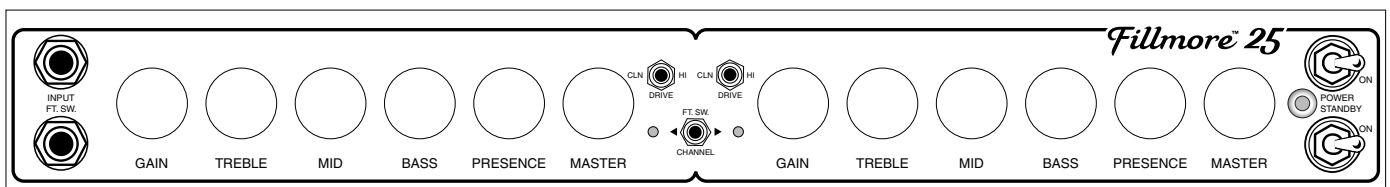
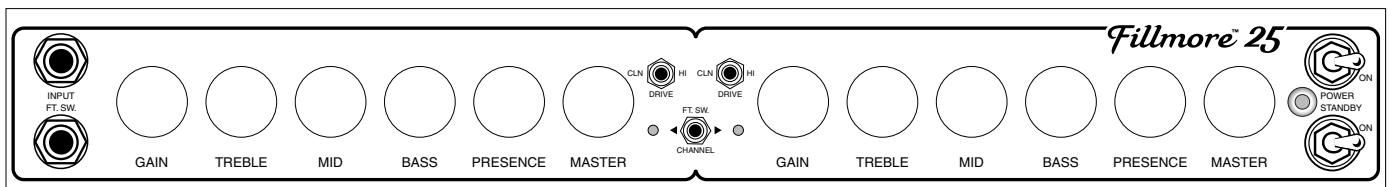
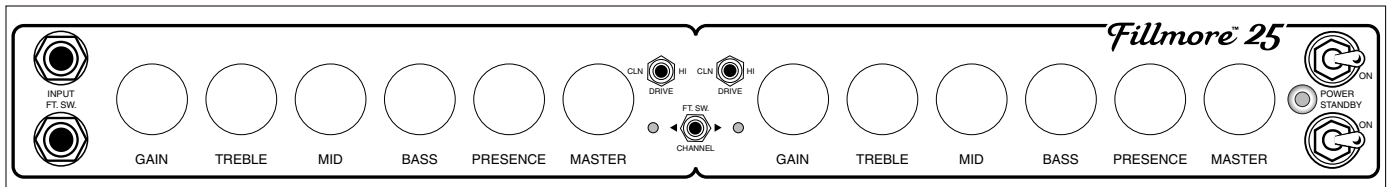
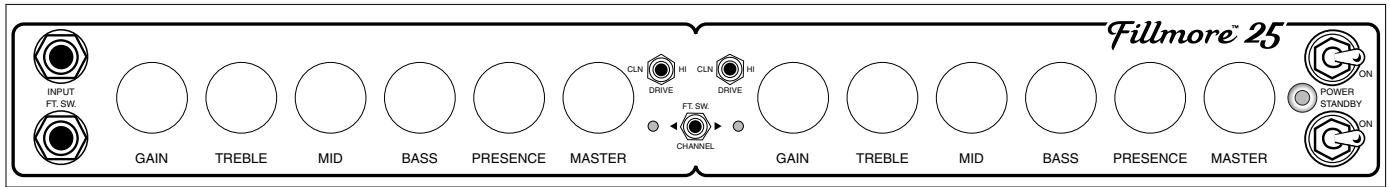

USER SETTINGS

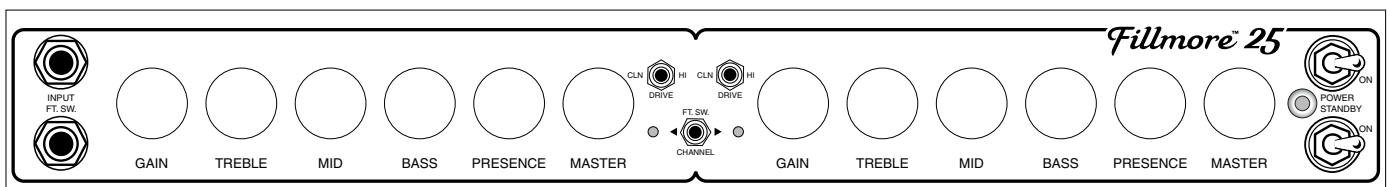
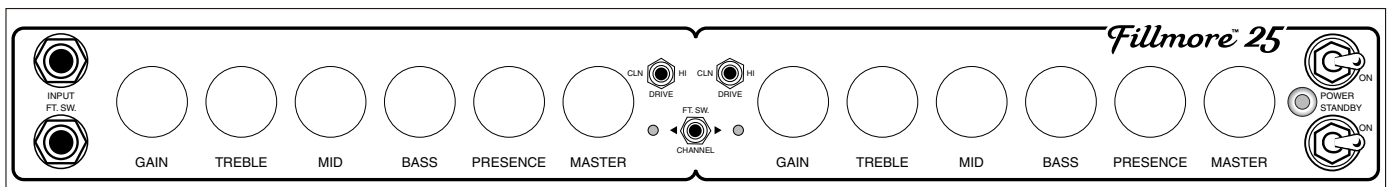
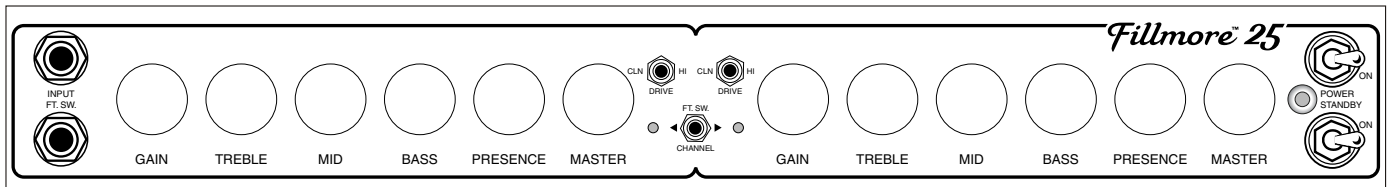
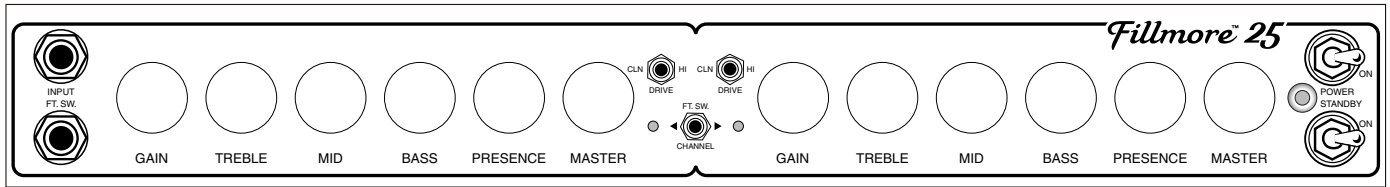

TUBE NOISE & MICROPHONICS:

You may occasionally experience some form of tube noise or microphonics. Certainly no cause for alarm, this quirky behavior comes with the territory and the Tone. Much like changing a light bulb, you don't need a technician to cure these types of minor user serviceable annoyances and in fact, you'll be amazed at how easy it is to cure tube problems...by simply swapping out a pre-amp or power tube!

First may we suggest that you set the amplifier up on something so that you can get to the tubes comfortably without having to bend down. It also helps to have adequate lighting as you will need to see the tube sockets clearly to swap tubes. **Use caution and common sense when touching the tubes after the amplifier has been on as they may be extremely hot!** If they are hot and you don't want to wait for them to cool off, try grasping them with a rag and also note that the glass down around the bulbous silvery tip is considerably less hot which makes it easier to handle. Gently rock the tube back and forth as you pull it away from its socket.

DIAGNOSING POWER TUBE FAILURE:

There are two main types of tube faults: shorts and noise. Both large and small tubes may fall prey to either of these problems but diagnosis and remedy is usually simple.

If a fuse blows, the problem is most likely a shorted power tube and shorts can either be mild or severe. In a mildly shorted tube the electron flow has overcome the control grid and excess current flows to the plate. You will usually hear the amp become distorted and begin to hum slightly. If this occurs, quickly look at the power tubes as you switch the amp to STANDBY and try to identify one as glowing red hot. It is likely that two of a pair will be glowing since the "shorted" tube will pull down the bias for its adjacent mates, but one tube may be glowing hotter — and that one is the culprit. The other two are often fine — unless they've been glowing bright red for several minutes.

Because there is no physical short inside the tube (just electrons rioting out of control) merely switching to STANDBY for a few moments then back to ON will usually cure the problem...at least temporarily. Watch the tubes carefully now. Should the problem recur, the intermittent tube will visibly start to over heat before the others and thus it can be identified. It should be replaced with one from the same color batch, shown on its label. Call us and we will send one out to you.

The severe short is not nearly so benign. In the worst cases, a major arcing short occurs between the plate and the cathode with visible lightning inside the glass and a major noise through the speaker. If this is seen to happen, IMMEDIATELY turn the amp to STANDBY. By this time the fuse probably will have blown. Such a short is usually caused by a physical breakdown inside the tube including contaminate coming loose or physical contact (or near contact) between the elements. Replace it and the fuse with the proper slo-blo type and power up the amp using the power up procedure as we described earlier in this manual.

TUBE NOISE:

Often caused by contamination within a tube, the culprit can usually be identified, and by lightly tapping on the glass, you will probably hear the noise change. Hearing some noise through the speakers while tapping on the 12AX7's is normal however. And the one nearer the INPUT will always sound louder because its output is being further amplified by the second 12AX7.

The power tubes should be all but quiet when they are tapped. If crackling or hissing changes with the tapping, you have probably found the problem. To confirm a noisy power tube, merely put the amplifier on Standby, remove it from its socket and turn it back on. It will cause no damage to run the amplifier briefly with one power tube missing. You may notice a slight background hum, however, as the push-pull becomes unbalanced. Whenever you are trying to diagnose a suspect tube, keep your other hand on the POWER and STANDBY switches ready to shut them off instantly in the unlikely case you provoke a major short.

If you think you've located a problem tube but aren't sure, we recommend substituting the suspect with a new one just to be sure of your diagnoses. You will be doing yourself and us a big favor by just following the simple guidelines previously mentioned regarding tube replacement. You'll probably be successful with much less effort than is required to disconnect everything and haul the unit to a technician who will basically perform the same simple tests. If the tubes are still within their six-month warranty period, we will happily send you a replacement. Just note the color designation on the tube label so that we can send you the appropriate match.

DIAGNOSING PRE-AMP TUBE PROBLEMS:

Because your amplifier is an all tube design, it is quite possible that you will at some point experience minor pre-amp tube noise. Rest assured - this is no cause for alarm and you can take care of the problem yourself in a matter of minutes by simply swapping tubes.

Let us begin by saying; It is a "very good" idea to keep at least a couple of spare pre-amp tubes on hand at all times to insure uninterrupted performance. These minor pre-amp tube problems can take many forms but can generally be described in two categories: Noise and Microphonics. Noise can be in the form of crackling, sputtering, white noise/hiss and/or hum. Microphonic problems usually appear in the form of a ringing or high pitched squealing that gets worse as the gain or volume is increased thus are more noticeable in the higher gain "HI" modes. Microphonic problems are easily identified because the problem is still present even with the instruments' volume off or unplugged altogether - unlike pick-up feedback which ceases as the instrument is turned down. Microphonic noise is caused by mechanical vibration and shock: think of banging a microphone around and you'll understand where the word came from.

The best way to approach a pre-amp tube problem is to see if it occurs only in one specific mode or channel. This should lead you to the tube needing replacement. Then all that remains is to swap the suspect tube for a known good performer. If you cannot narrow down the trouble to a specific mode or channel, the problem may be the small tube that drives the power tubes which is operational in all modes and channels. Though rare, a problem with the driver tube would show up in all aspects of performance - so if you can't narrow the problem down to being mode or channel specific, you may want to try replacing the driver tube. Driver problems generally show themselves in the form of crackling or hum in all modes of performance and/or weak overall output from the amplifier. Occasionally an anemic driver tube will cause the amplifier to sound flat and lifeless, but this is somewhat uncommon, as worn power tubes are a more likely suspect for this type of problem.

Sometimes making the diagnosis is more trouble than it's worth and it's faster and easier to merely replace the small pre-amp tubes ONE AT A TIME with a replacement known to be good. But MAKE SURE you keep returning the tubes to their original socket until you hit the one that cures the problem. You'll notice that tubes located nearer to the INPUT jack always sound noisier...but this is because they are at the start of the chain and their noise gets amplified over and over by the tubes that follow. The tube that goes into this "input socket" (usually labeled V1) needs to be the least noisy of the bunch. The tube that goes at the end of the preamp chain - just ahead of the power tubes - can be quite noisy without causing any problem at all. The tubes in your amp have already been located in the most appropriate sockets and this is why you should NEVER pull them all out at once and ALWAYS swap them one at a time. ALWAYS return a perfectly good tube to its original socket. Also it's a good idea to put the amp on STANDBY when swapping tubes to reduce the heat build up in the tubes themselves and to prevent explosive noises (which can still occur even if you are pulling the tubes away from their sockets gently) from coming through the speaker.

Remember, take your time, be patient and chances are real good that you can fix your amp yourself by finding and replacing the bad tube. It kills us to see someone who has shipped their amp back to us...and all it needed was a simple tube replacement! If you must send back your amp, remove the chassis from the cabinet by unscrewing the four mounting bolts on the bottom top. The chassis then slides back like a drawer and comes out from the back. Remove the big power tubes and mark them according to their location from left to right 1, 2 etc. They need to be wrapped separately with plenty of wadded up newspaper around them and put in a smaller box within the larger carton. Remove the Rectifier tubes and wrap them also. You can leave the preamp tubes in or remove them and wrap them separately being sure to label their location. (See Tube Task Chart.)

To wrap the chassis, use plenty of tightly wadded up newspaper so there is at least six inches of "crush space" between the chassis and the cardboard box. Bubble wrap also works well, but please DON'T use styrene peanuts - they will shift during transit and get lodged inside your electronics as well as allowing your amp to end up at the bottom of the box unprotected and possibly damaged.

Pre-amp tubes don't normally wear out as a rule. Therefore, it is not a good idea to change them just for the sake of changing them. If there isn't a problem - don't fix it. If there is no result from your substitutions, it may be possible that you have more than one problematic tube. Though rare, this does happen and though it makes the troubleshooting process a little more intimidating, it is still possible to cure the problem yourself.

NOTE: *It is normal to hear a slight metallic ringing sound when tapping on the preamp tubes. As long as the tube does not break into oscillation or start crackling or any other form of bizarre noise, it is considered normal and functional.*

SPEAKER IMPEDANCE MATCHING & HOOK-UP GUIDE:

IMPEDANCE: Wiring up speakers to provide the most effective load and making sure that all of them are in phase will help in creating the best sound possible. This is not too difficult, as long as you understand a few things about loading and how to connect your speakers to provide an optimal resistive load.

MESA/Boogie amplifiers can handle 4 and 8 ohms effectively. Never run below 4 ohms in a tube amplifier unless you are absolutely certain that the system can handle it properly; this can cause damage to the Output transformer. A few amplifiers can handle 2 ohms effectively without damaging them (for example the **MESA'S Bass 400+**). You can always have a higher resistance (16 ohms, for example) without damaging results, but too low of a resistance will likely cause problems.

MIS-MATCHING: When running a higher resistance (for example: 8 ohm output into 16 ohm cabinet), a slightly different feel and response will be eminent. A slight mismatch can provide a darker smoother tone with a little less output and attack. This response is a result of the amplifier running a bit cooler. Sometimes when using more than one cabinet a mismatch will be the only option.

WHAT IS MY CABINETS IMPEDANCE?: If you have only a single speaker, you just match that single speakers impedance to the amplifier, and you are done. In many cases, you will have a number of speakers, and then you must calculate the "load" that the amplifier will need to support. There are generally three ways to wire multiple speakers together. They are as follows:

SERIES: When you wire (hook-up) speakers in Series, the speakers resistance (as measured in ohms) is additive - i.e. putting two 8 ohm speakers in Series results in a 16 ohm load.

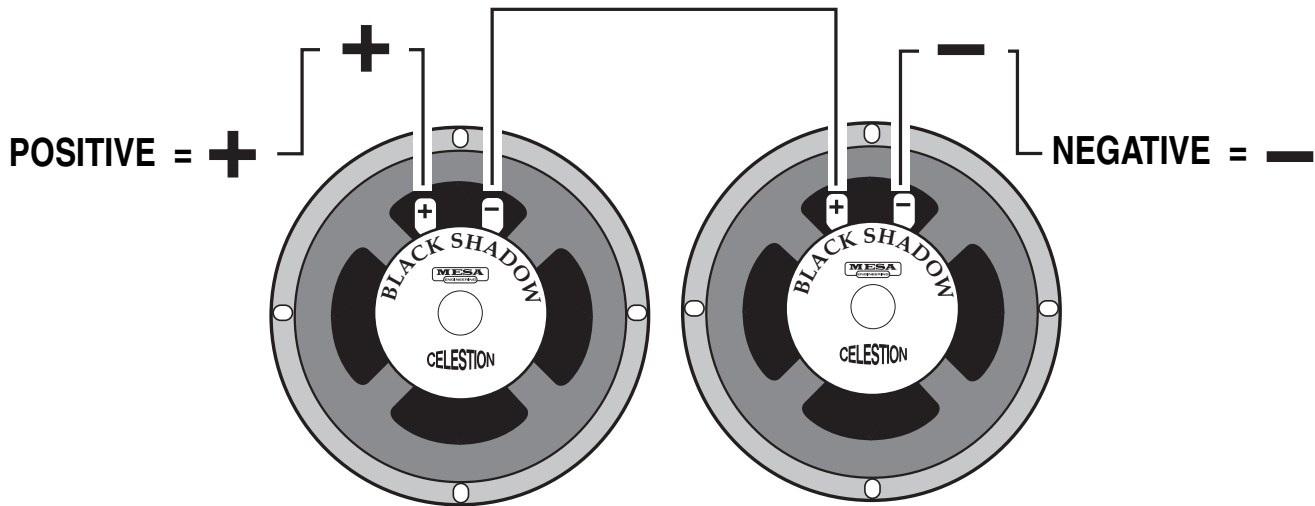

Speaker A = 8 Ohms

Speaker B = 8 Ohms

SERIES: Connect the Negative side of Speaker A
to the Positive side of Speaker B

SPEAKER IMPEDANCE MATCHING & HOOK-UP GUIDE: (Continued)

PARALLEL: When wiring in parallel, the resistance of the speakers decreases. Two 8 ohm speakers wired in (hooked-up) Parallel results in a 4 ohm load. It's easy to calculate the effect of a resistive load when all the speakers are all the same resistance. It is really not suggested to wire different resistive load values in Parallel (8 and 4, 16 and 8 etc.) The formula for figuring the total impedance in Parallel is the multiplication of the two loads divided by the sum of the two loads - i.e. putting two 8 ohm speakers in Parallel results in a 4 ohm load. Connect the Positive side of Speaker A to the Positive side of Speaker B - Connect the Negative side of Speaker A to the Negative side of Speaker B.

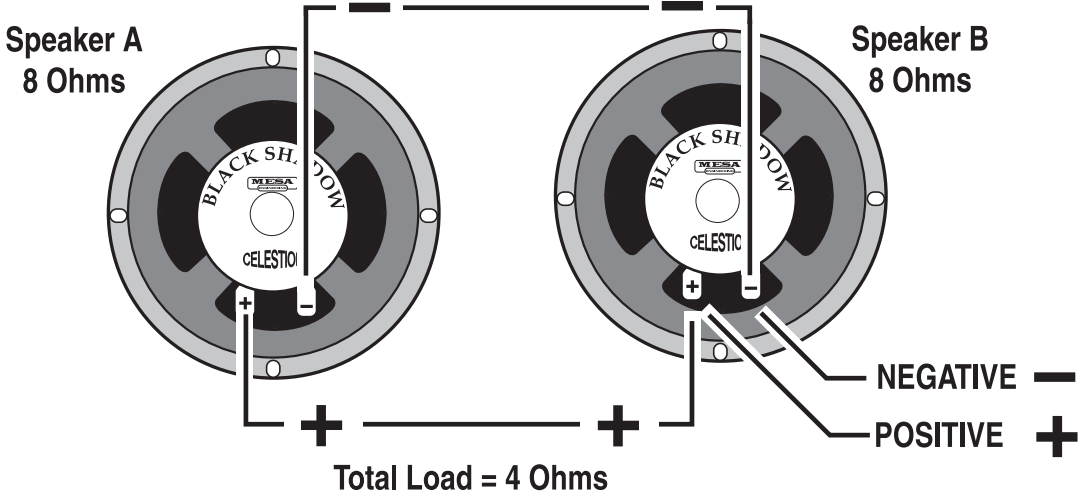

COMBINATION OF SERIES & PARALLEL: This is really just two sets of Series wired speakers connected in Parallel. This is how you maintain a consistent load with multiple speakers. The importance of this is more evident when you have more than one cabinet to connect to your amplifier. This is when you need to figure out the loads and how to wire them up without applying too low of a resistance on the amplifier.

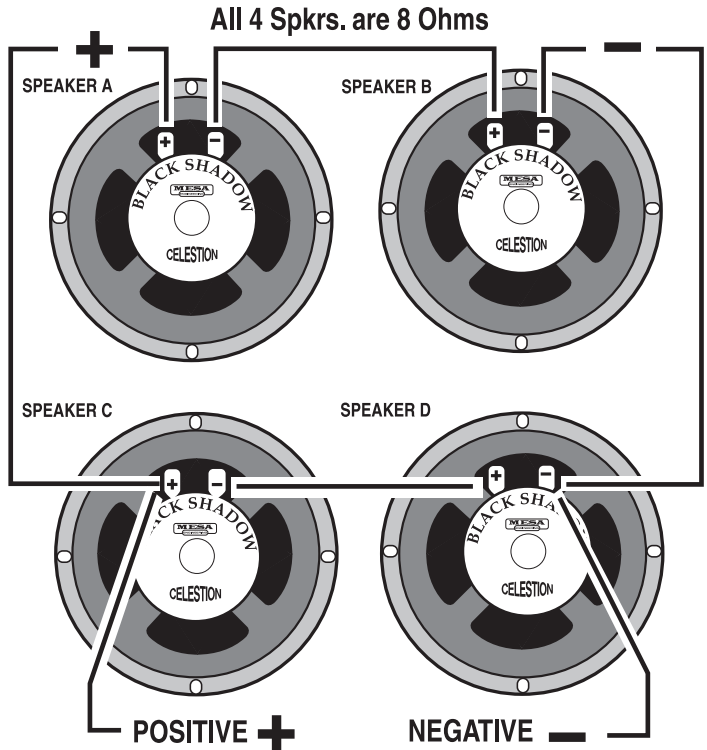

Simply connect the Positive side of Speaker A to the Positive side of Speaker C.

Connect the Negative side of Speaker A to the Positive side of Speaker B. Next, connect the Negative side of Speaker C to the Positive side of Speaker D.

And lastly, connect the Negative side of Speaker B to the Negative side of Speaker D.

4 Eight (8) Ohm speakers wired in Series Parallel = a Total Load of 8 Ohms.

WIRING SCHEMES...Amplifier to Speaker Cabinets

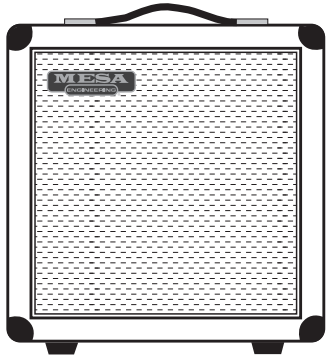
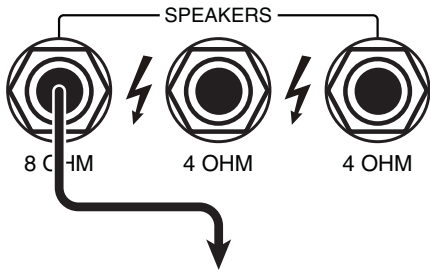

1

8 Ohm Cabinet

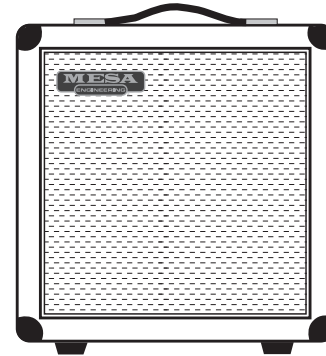
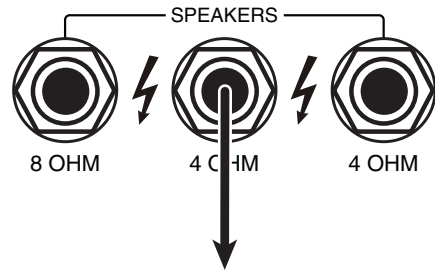

2

4 Ohm Cabinet

3

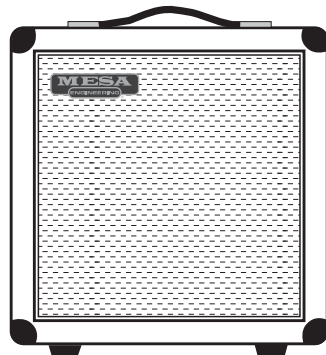
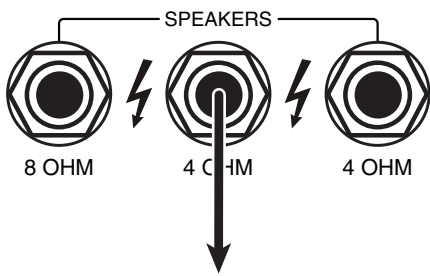

**8 Ohm Cabinet
SAFE MISMATCH**

4

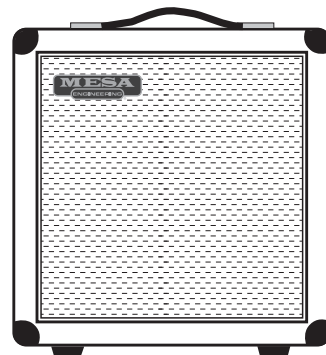
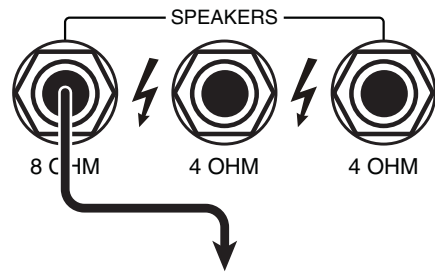

**16 Ohm Cabinet
SAFE MISMATCH**

WIRING SCHEMES...Amplifier to Speaker Cabinets

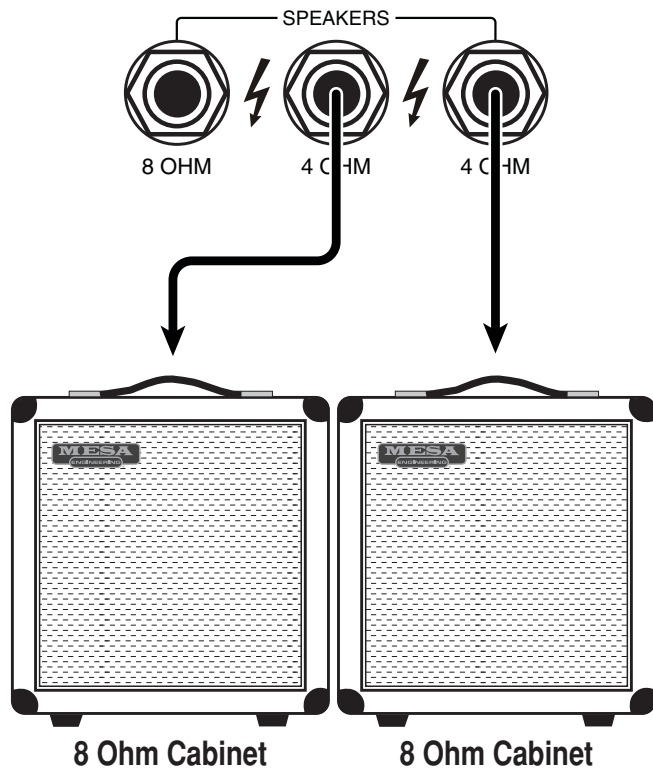

5

BEFORE CHANGING TUBES FLIP POWER & STANDBY SWITCH TO OFF

FILLMORE™ 25

TUBE REPLACEMENT DIAGRAM

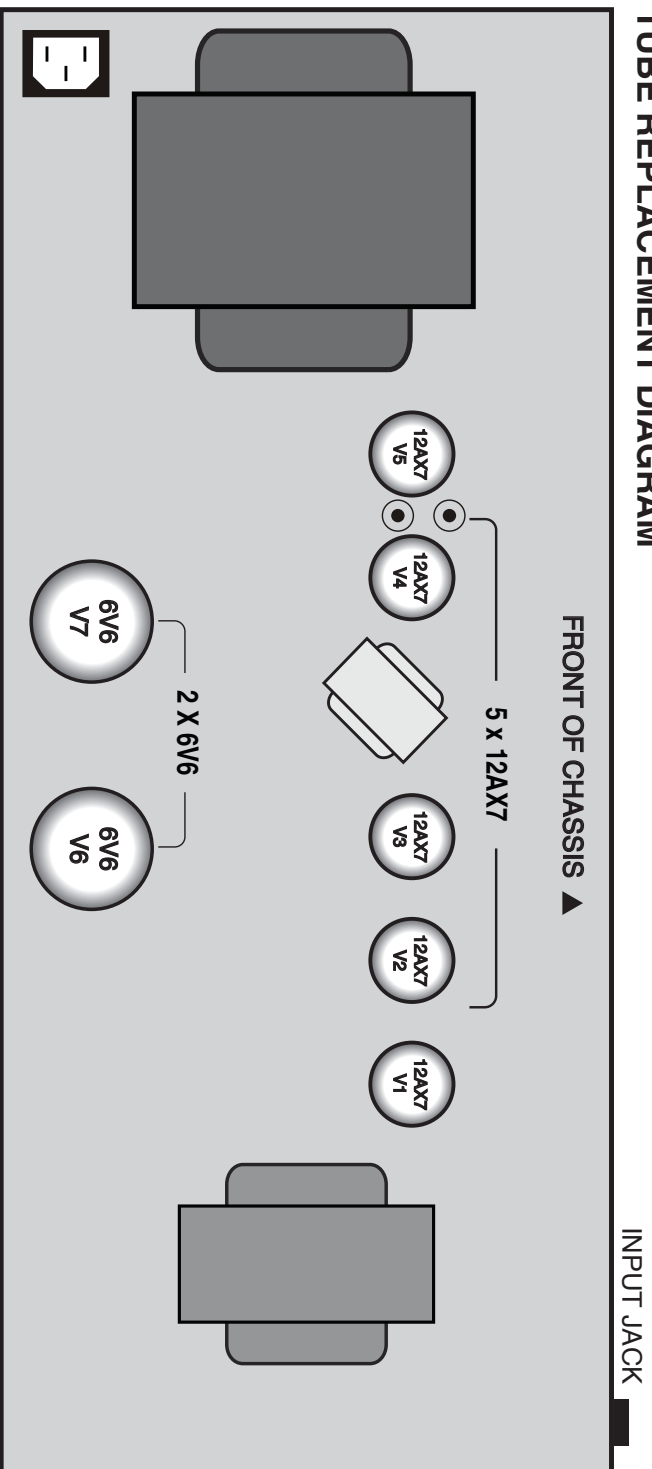

TO MAINTAIN WARRANTY, USE MESA/BOOGIE® TUBES WHEN REPLACEMENT IS NECESSARY

FOR CUSTOMER SUPPORT, PLEASE CALL 707-778-6565 MONDAY-THURSDAY 9-5 PST, OR EMAIL US AT INFO@MESABOOGIE.COM

FRONT PANEL: FILLMORE™ 25

**ALL KNOBS
PT# 408670**

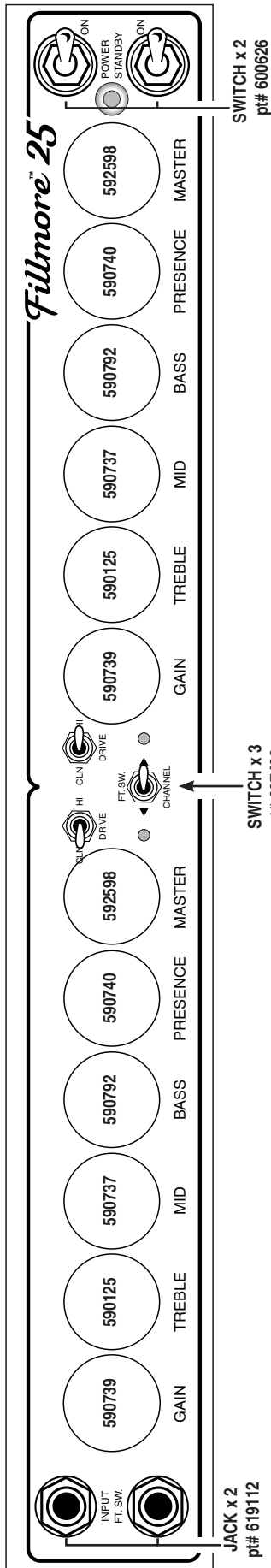

REAR PANEL: FILLMORE™ 25

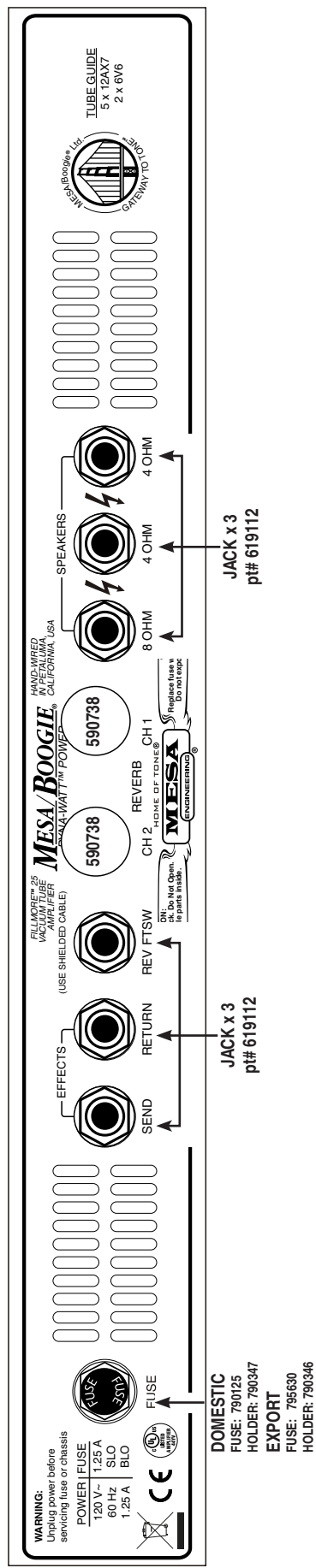

MESA/BOOGIE[®]

The Spirit of Art in Technology[™]

Thank you for trusting MESA/Boogie[®] to be your amplifier company and we wish you many years of toneful enjoyment from this handcrafted instrument.

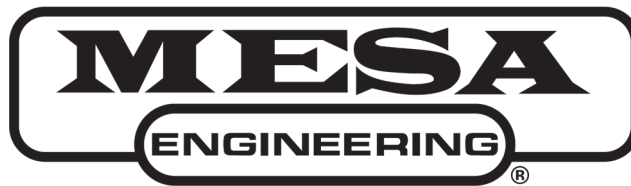

The Spirit of Art in Technology™



(707) 778-6565 FAX NO. (707) 765-1503
1317 Ross Street Petaluma, CA 94954
USA