

WHD

WHD-600DX

USER MANUAL

INFORMATION FOR YOUR SAFETY!

THE FCC REGULATION WARNING (for USA)

This equipment has been tested and found to comply with the limits for a Class B digital device, pursuant to Part 15 of the FCC Rules.

These limits are designed to provide reasonable protection against harmful interference in a residential installation. This equipment generates, uses, and can radiate radio frequency energy and, if not installed and used in accordance with the instructions, may cause harmful interference to radio communications. However, there is no guarantee that interference will not occur in a particular installation. If this equipment does cause harmful interference to radio or television reception, which can be determined by turning the equipment off and on, the user is encouraged to try to correct the interference by one or more of the following measures:

- Reorient or relocate the receiving antenna.
- Increase the separation between the equipment and receiver.
- Connect the equipment into an outlet on a circuit different from that to which the receiver is connected.
- Consult the dealer or an experienced radio/TV technician for help.

Unauthorized changes or modification to this system can void the user's authority to operate this equipment.

CAUTION

The normal function of the product may be disturbed by Strong Electro Magnetic Interference. If so, simply reset the product to resume normal operation by following the owner's manual. In case the function could not resume, please use the product in other location.

PRECAUTIONS

PLEASE READ CAREFULLY BEFORE PROCEEDING

Please keep this manual in a safe place for future reference.

Power Supply

Please connect the designated AC adaptor to an AC outlet of the correct voltage.

Do not connect it to an AC outlet of voltage other than that for which your instrument is intended.

Unplug the AC power adaptor when not using the instrument, or during electrical storms.

Connections

Before connecting the instrument to other devices, turn off the power to all units. This will help prevent malfunction and / or damage to other devices.

Location

Do not expose the instrument to the following conditions to avoid deformation, discoloration, or more serious damage:

Direct sunlight
 Extreme temperature or humidity
 Excessive dusty or dirty location
 Strong vibrations or shocks
 Close to magnetic fields

Interference with other electrical devices

Radios and televisions placed nearby may experience reception interference. Operate this unit at a suitable distance from radios and televisions.

Cleaning

Clean only with a soft, dry cloth.
 Do not use paint thinners, solvents, cleaning fluids, or chemical-impregnated wiping cloths.

Handling

Do not apply excessive force to the switches or controls.

Do not let paper, metallic, or other objects into the instrument. If this happens, remove the electric plug from the outlet. Then have the instrument inspected by qualified service personnel.

Disconnect all cables before moving the instrument.

Contents

Main Features	4	Record	
Panel & Display Description		Preparing Record.....	15
Front Panel.....	5	Start / Stop Recording.....	15
Side Panel (Connecting).....	6	Coach	
LCD Display.....	7	About Coach Mode.....	16
Setup		Coach Mode Control.....	16
Connecting Pads and Pedals.....	8	Qut Cnt (Quiet Count).....	16
Getting Ready to Play		Change Up.....	17
Setting Up the Power Supply.....	9	Beat Check.....	18
Turning the Power On/Off.....	9	DBT (Double Bass Trigger)	
Quick Play		Turn the DBT Function On.....	19
Drum Kits and Voices.....	10	Tempo	19
Playing Techniques.....	11	Utility Mode (Utility)	
Select a Preset Drum Kit and Create a User Drum Kit		The Drum Pad Trigger Settings.....	20
Kit		The Drum Module Settings.....	21
About the Preset and User Drum Kit.....	12	Troubleshooting	22
Edit the Drum Kit Parameters.....	12	Prompt Messages	22
Edit the Voice Parameters.....	12	Specifications	23
Save User Drum Kit.....	13	Appendix	
Playing Along with a Song		Drum Kit List.....	23
Playing Along with a Song.....	14	Drum Voice List	24
Muting the Drums in Songs.....	14	Song List.....	27
Metronome.....	14	GM Drum Kit List.....	28
		GM Melody Voice List.....	30
		MIDI Implementation Chart.....	31

Main Features

Bring the Professional Experience to Your Performance Natural and Realistic Voices

This digital drum has equipped with all new voices, which vastly improved sound quality and will reach a super natural and realistic sense for your ears. No matter playing the stroke roll or striking pads with velocity dynamic, all of these let you enjoy delicate nuances and natural voice, capture the unique characteristics of acoustic drum kit.

Fashionable Appearance

Compact, elegant appearance, only occupy a little place when fold it up. Except for a perfect learning assistant, it also can be exquisite furniture decorated in your house.

Amazing DBT Function

Easy to achieve double bass pedal techniques here. The frequency is adjustable.

Scientific COACH Practicing

Provide three coach modes with dozens of common beat practice. Automatically score function intuitively reflects practice condition.

USB MIDI Output

This digital drum equipped with an USB MIDI output, it is available to connect with smart devices, such as an iPad, through a Camera kit.

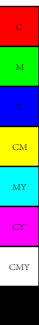

Panel Description

Front Panel

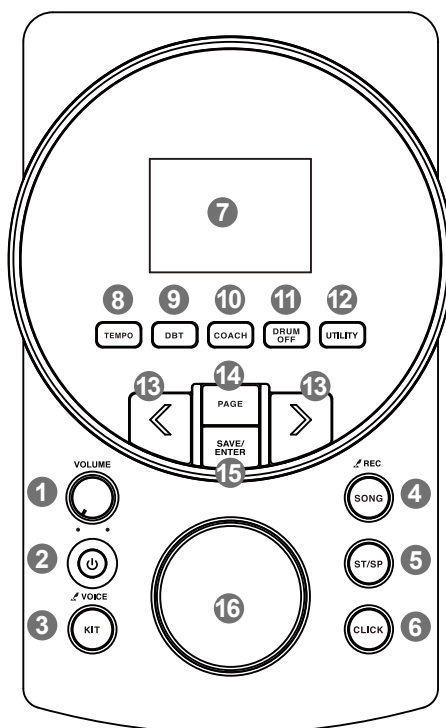

1. [VOLUME] Knob

Adjust the phone volume level.

Note:

Rotate the [VOLUME] knob anticlockwise to the minimum position before power on.

2. [POWER] Button

Press this button to power on/ off the module.

3. [KIT/VOICE] Button

Shortly press: enter drum kit mode.
Press and hold: enter voice mode.

4. [SONG/REC] Button

Shortly press: enter the song mode.
Press and hold: enter the quick record mode.

5. [START/STOP] Button

Start / Stop playing songs.

6. [CLICK] Button

Start/Stop the metronome; enter the metronome parameter setting mode.

7. LCD Display

Shows the name and parameter settings of Kit, Voice, Song and so on.

8. [TEMPO] Button

Adjust the tempo value.

9. [DBT] (DOUBLE BASS TRIGGER) Button

Turn DBT function on/ off.
*Turn DBT function on. It can generate two or three continuous kick sounds when you step on the bass drum only once. Easy to achieve double bass pedal techniques.

10. [COACH] Button

Enter learning mode.

11. [DRUM OFF] Button

Mute the drum part of the pattern.

12. [UTILITY] Button

Enter the utility mode.

13. [<]/[>]Button

Gradually increasing or decreasing the value of settings.

14. [PAGE] Button

Switch between the settings of different functions.

15. [SAVE/ENTER] Button

Save the drum kit / pad settings.

16. DATA DIAL

Use this to select drum kits or to quick edit values (increase/decrease values).

Panel Description

Side Panel (Connecting)

Note:

To prevent malfunction and equipment failure, always turn down the volume, and turn off all the units before making any connections.

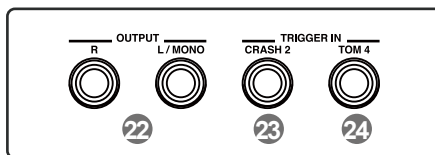
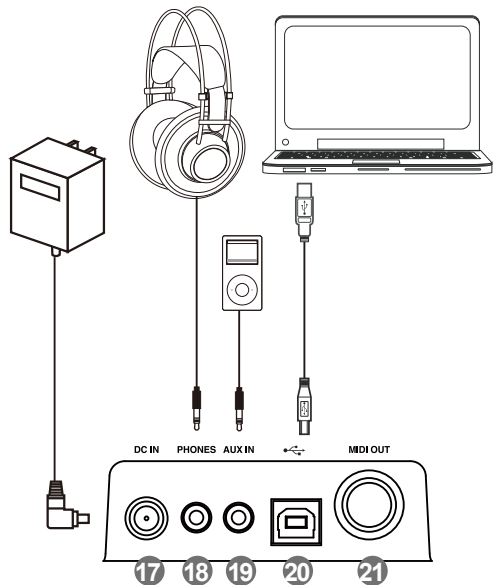

17. DC IN jack

Connect the AC adaptor here. Plug the AC adaptor cable into the DC IN jack.

18. PHONES jack (1/8")

Connect stereo headphones here.

19. AUX IN jack (1/8")

For connecting an extra audio player, for example, MP3 and so on via a stereo plug. You can enjoy playing the drum along with your favorite songs.

20. USB MIDI Terminal

Connect the PC/USB host with audio devices.

Note:

Only transmit MIDI data.

21. MIDI OUT Terminal

Use this to connect extra MIDI sequencer. you can send MIDI data to an extra MIDI device or a PC/laptop.

22. OUTPUT jack (L/MONO, R) (2 x1/4")

Connect to your audio system or amplifier. For stereo output use both the L/MONO and R jacks. For monaural output use the L/MONO jack

23. CRASH 2 jack (1/4")

This allows you to connect additional Crash 2.

24. TOM 4 jack (1/4")

This allows you to connect additional Tom 4.

LCD Display

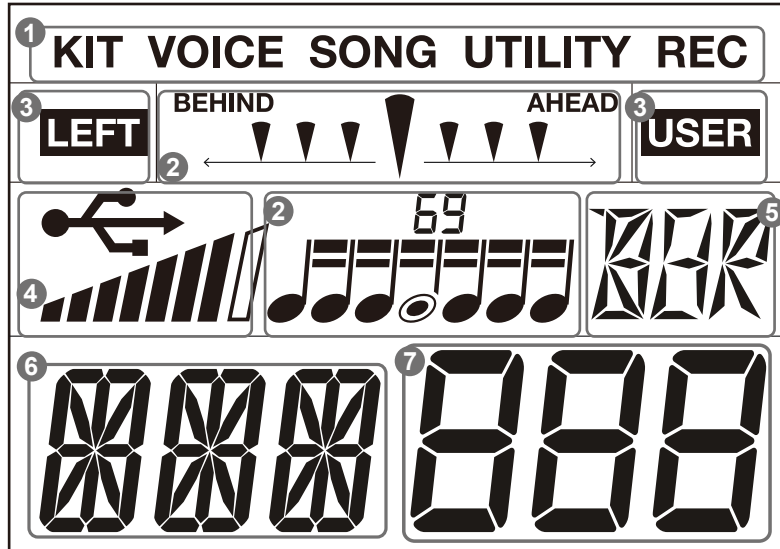

1. Mode

Display the current mode, such as KIT, VOICE, SONG, and UTILITY and so on.

2. Coach Mode

Display current beat accuracy and rhythm type.

3. The Second Level Mode

When the mode is turned on, the LCD displays current mode.

4. External Device and Strike Strength

Display the connected external device and current striking strength.

5. Pad Name

Display the current selected pad name.

6. Parameter Type

Display current parameter type, for instance, Volume, Curve and so on.

7. Parameter Value

Display the value which corresponding to the parameter or the number of Song/Kit/Voice.

Setup

Caution!

To prevent electric shock and damage to drum module or other devices, always turn off the power of all devices before making any connections.

Connecting Pads and Pedals

Standard configuration: KICK, SNARE (Double trigger), TOM 1~3, CRASH 1 (Choke), RIDE (Choke), HI-HAT, PEDAL (HI-HAT).

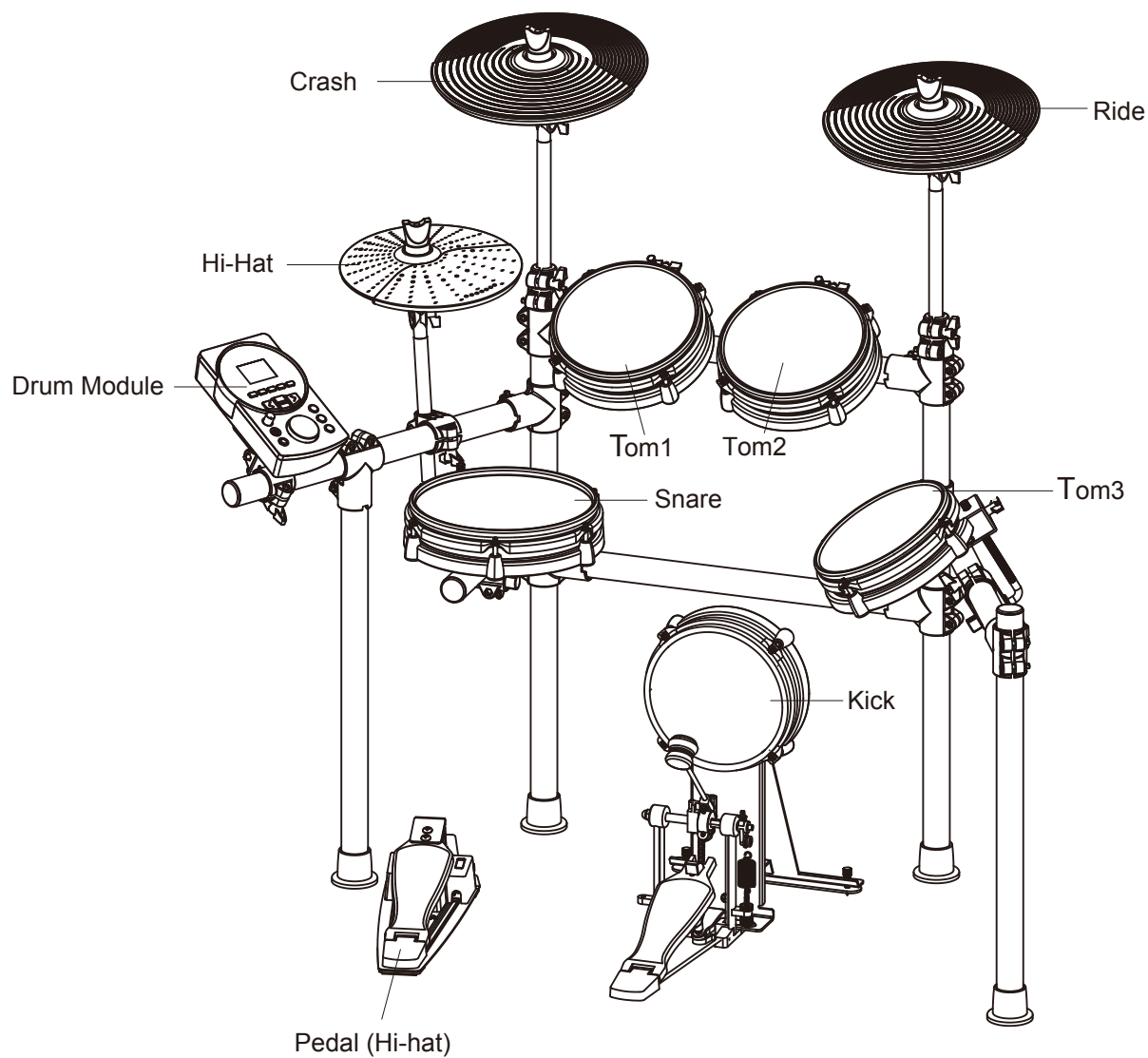

Note:

1. Using the cables provided, connect each Trigger input jack on the rear panel of the module, and make sure each pad is connected to its corresponding trigger input jack.
2. For details on assembling the drum stand, attaching the digital drum and connecting pads, refer to the *Installation Manual* description.

Getting Ready to Play

Setting up the Power Supply

1. Connect the DC plug of the AC power adaptor to the DC IN jack on the side panel.
2. Connect the other end of the power cord to the AC outlet.

Note:

1. Only use the voltage specified as correct for the drum module.
2. Even when the module is turned off, electricity is still flowing to the module at the minimum level. When you are not using the drum module for a long time, make sure to unplug the AC power adaptor from the wall AC outlet.

Turning the Power On/Off

Turning the power on

1. Please make sure that the volume has been adjusted minimize.
2. Press the [POWER] button.
3. Listen through the headphone.
4. Striking the pads and adjust the volume by slowly turning the [VOLUME] knob toward the right direction. Keep turning until you get an appropriate value.

VOLUME

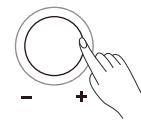

Note:

1. Make sure that you have made all necessary connections right (trigger, audio and so on), turn down all volume controls of the module and other audio equipments.

Turning the power off

1. Minimize the volume of the module and connected audio devices.
2. Turn the connected external audio device off.
3. Press the [POWER] button again.

Note:

The drum module automatically saves all current settings before it turns off, you can also restore the factory setting by the following steps:

- a) Press the [<] / [>] buttons simultaneously.
- b) Press the [POWER] button.
- c) When the LCD displays "FAC SET", it indicates the factory setting is finished.

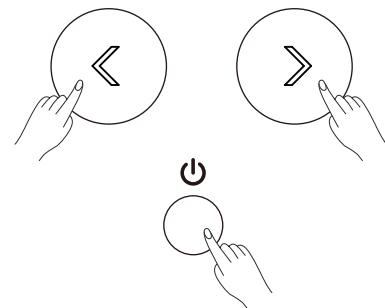

About the Auto Power Off Function

To prevent unnecessary power consumption, this function automatically turns the power off if no buttons or keys are operated for approximately 30 minutes. If desired, you can disable or enable this function. Refer to **Utility Settings**.

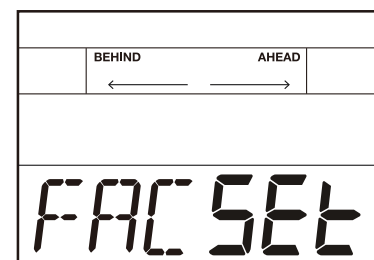

Quick Play

Drum Kits and Voices

An acoustic drum has only a fixed kit, but the digital has a lot. It is a particular characteristic of digital drum.

The structure of a drum kit is shown on the right:

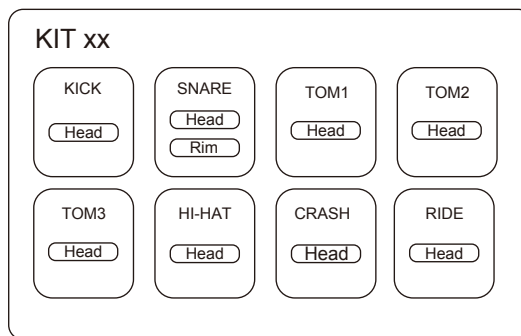

Drum Kits and Voices

1. Shortly press the [KIT/ VOICE] button, enter the drum kit menu. The screen is shown on the right:

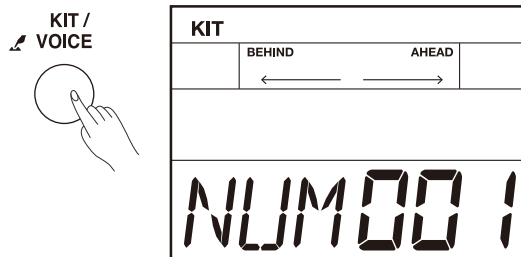

2. Press the [←]/[→] button or turn the [DIAL] to select your desired drum kit. (Refer to **Drum Kit List**)

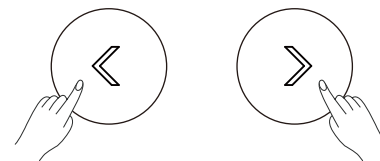

Selecting a voice

While striking the pads, you can enjoy the ensemble sound effect. If you are not satisfied with the voice of any pads, change the voice as you want.

1. Press the [KIT/ VOICE] button for 2 seconds to enter the voice menu. The screen displayed is shown on the right:
2. Strike the pad you want. The screen will display the name of current pad.
3. While striking the pad, press the [←]/[→] button or turn the [DIAL] until you get an appropriate voice for your pads. (Refer to **Voice List**)

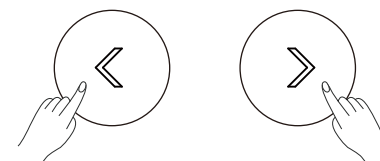
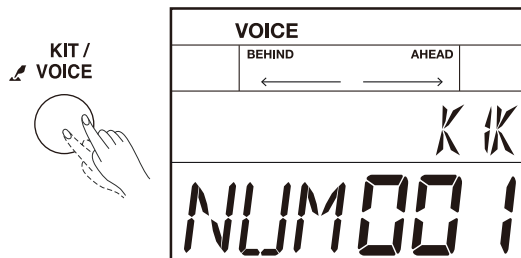

Playing Techniques

This section introduces various performance functions to make your performance professional. Similar to an acoustic drum kit, the digital drum responds differently to various playing techniques and dynamics. All the pads are velocity sensitive. And some voices change timbre depending on the striking force.

Pad

Only the snare drum can detect both head shot and rim shot.

Head Shot

Strike only the head of the pad.

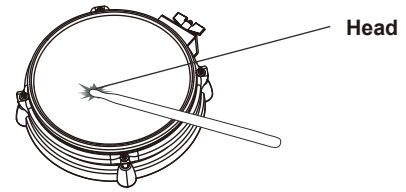

Rim Shot

Strike the head and the rim of the pad simultaneously. Or you can only strike the rim of the pad.

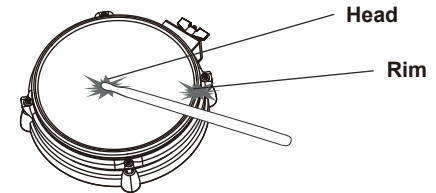

Cymbal

Cymbal Bow shot

Playing the middle area of the cymbal.

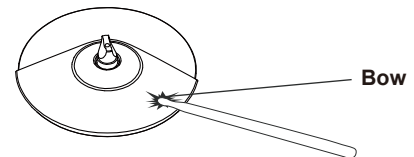

Choke Play

Both Ride and Crash cymbals have cymbal choke. But hi-hat don't have the cymbal choke.

Choking the crash/ride edge with the hand immediately after hitting the crash/ride mutes the crash/ride sound.

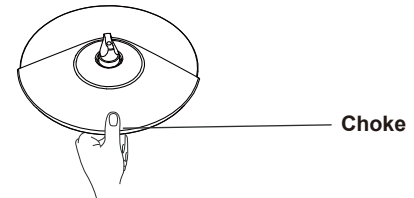

Hi-Hat

Hi-Hat Pedal Change

With different positions the pedal pressed down, the voice of pad varied while you are striking the Hi-Hat pad. And this is similar to an acoustic drum.

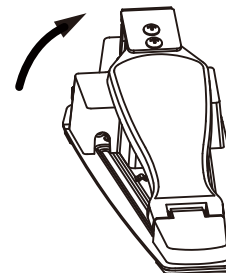

Open Hi-Hat

Strike the Hi-Hat pad without pressing the pedal.

Closed Hi-Hat

Strike the Hi-Hat pad with the pedal pressed completely down.

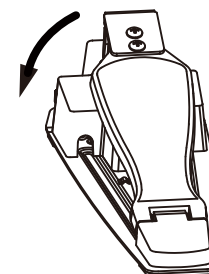

Hi-Hat Pedal

Press down the hi-hat controller's pedal to create a foot-close sound without having to strike the hi-hat pad.

Splash

Playing the hi-hat with the pedal fully pressed and then instantly opening it.

Select a Preset Drum Kit and Create a User Drum Kit

About the Preset and User Drum Kit

From No.1 to 30 are preset drum kits, and the drum kits from No.31 to 40 are user drum kits. You can edit the parameters of drum kit (from No.1-30), and save them into user drum kits (from No.31-40).

Note:

Please save your own parameter or voice after edited, otherwise, all data will lost.

Edit the Drum Kit Parameters

Change the drum kit volume, the overall effect of drum kit will be affected. It means if you increase the volume of drum kit, all volume of the pads will be increased.

1. Press the [KIT] button, the LCD will display the kit menu.
2. Repeatedly press the [PAGE] button to select the item that you want to edit.

Parameter	Value	LCD Display	Description
KIT NAME	Preset: 1~30 User: 31-40	NUM XXX	Drum kit selection.
VOLUME	0~127	VOL XXX	Adjust the volume of drum kit; the volume of each pad will be changed.

3. Press the [<]/[>] button or turn the [DIAL] to adjust parameter value.

Edit the Voice Parameters

Edit parameters of one pad will not affect others. For example, if you increased the volume of snare, the other pads wouldn't change.

1. Press the [KIT/VOICE] button for 2 seconds and the LCD will display the voice menu.
2. Strike the pad that you want to edit.
3. Repeatedly press the [PAGE] button to select an item you want.

Parameter	Value	LCD Display	Description	Triggers :
VOICE NAME	1~408	NUM XXX	Select a voice.	KIK (KICK) Sn (Snare) SnR (Snare Rim) T1 (Tom1) T2 (Tom2) T3 (Tom3) T4(Tom4) HH (Hi-hat) C1 (Crash1) C2(Crash2) Rd (Ride) Pd (Hi-hat Pedal) PS (Hi-hat Splash)
VOLUME	0~127	VOL XXX	Adjust the volume of voice.	

4. Press the [<]/[>] button or turn the [DIAL] to adjust parameter value.

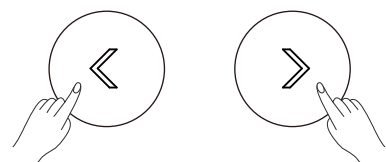
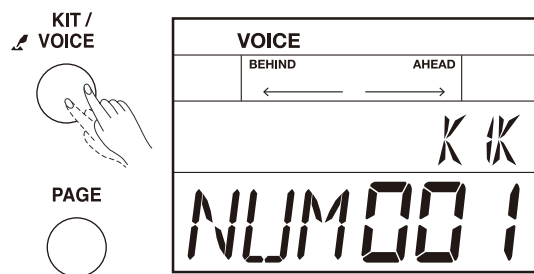
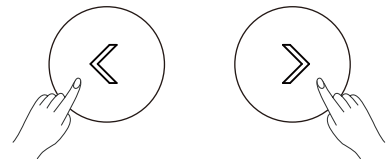
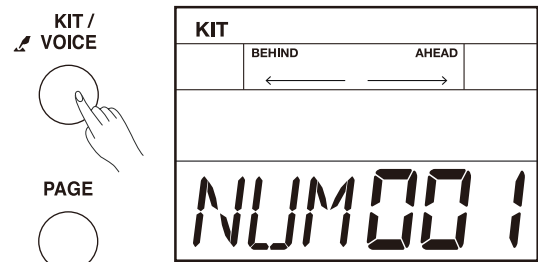

Select a Preset Drum Kit and Create a User Drum Kit

Save User Drum Kit

1. While in the drum kit and voice edit menu, press the [SAVE/ ENTER] button to save all changes.

SAVE /
ENTER

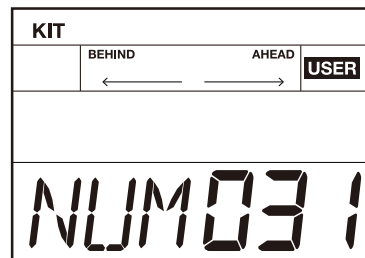

2. Use the [<]/[>] button or turn the [DIAL] to select a user drum kit (From NO.31 to 40).
The number of kit starts flashing at the same time.

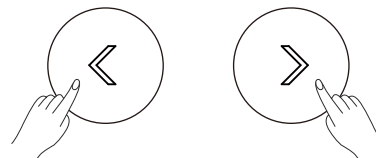

3. Press the [SAVE/ ENTER] button again; the LCD will display "OK", which indicates all data has been saved successfully.

SAVE /
ENTER

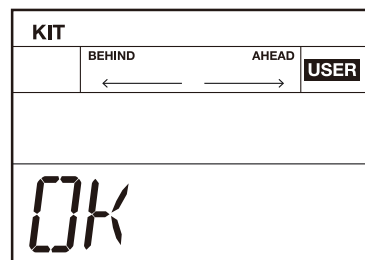

Playing Along with a Song

In order to have a better performance experience, a variety of styles can be selected. Each one offers you to practice. (Refer to the **Song List**) You can play the drums while listening to one of these songs. A song contains Drum part and Accompaniment part. Drum part means the rhythm you played on the pads; the Accompaniment part means percussion and melody. The volume of each part can be adjusted.

Playing Along with a Song

1. Press the [SONG] button to enter the selection menu.
2. Repeatedly press the [PAGE] button to select the parameter that you want to edit.

Parameter	Value	LCD Display	Description
SONG SELECT	1~85	NUM XXX	Select a song.
ACC VOLUME	0~8	ACC XXX	Adjust the background volume.
DRUM VOLUME	0~8	DRM XXX	Adjust the drum volume.

3. Use the [<]/[>] button or turn the [DIAL] to adjust the parameter value. Press the [<]/[>] buttons simultaneously to mute songs.
4. Press the [START/STOP] button to play/stop songs.

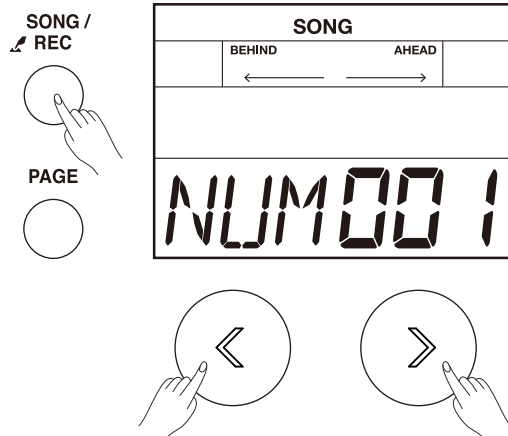

Muting the Drums in Songs

Press the [DRUM OFF] button to enable and disable the drum mute function. When DRUM OFF is enabled, the LED will turn on

Metronome

Practicing with the metronome is the best way to follow the beats. Choose a right tempo for your learning/ performance require.

Starting/ Stopping the Metronome and Its Feature

1. Press the [CLICK] button. The metronome will start playing, and the light of the [CLICK] button will blink with the tempo.
2. Repeatedly press the [PAGE] button to select the parameter you want to edit. Adjustable parameters are shown below:

Parameter	Value	LCD Display	Description
TIME	0-9/2, 0-9/4,	SIG XXX	Adjust the time signature.
SIGNATURE	0-9/8, 0-9/16		
INTERVAL	1/2, 3/8, 1/4, 1/8, 1/12, 1/16	INT XXX	Adjust the rhythm interval.
VOLUME	0~5	VOL XXX	Adjust the volume of metronome.
NAME	1~6	NUM XXX	Select the metronome voice.

3. Use the [<]/[>] button or turn the [DIAL] to change the parameter value.
4. Press the [CLICK] button again to stop the metronome, the light will be off.

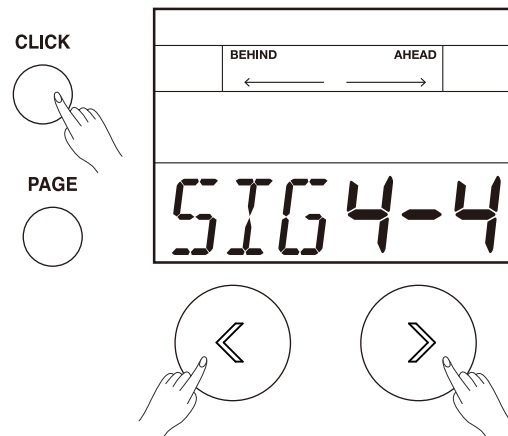

Record

This digital drum offers you easily record your own performance. Maximize 2500 notes could be recorded in one user song.

Preparing and starting record, refer to the details bellow:

Preparing Record

1. Press the [SONG/REC] button for 2 seconds to enter the Record-prepare mode, the light of the [SONG/REC] button start flashing, please select which user songs(81-85) you want to record.
2. Press the [START/STOP] button, the LCD displays "RDY---". It means the record is standby. If you want to exit the record-prepare mode, press the [SONG]/ [KIT] button.

Start / Stop recording

1. You can start recording in real time while in the preparing record menu, there are two ways to start record:
 - Press the [START/STOP] button.
 - Strike one pad.
2. Recoding begins after 4 beats count-in.
3. While recording, the light of the [SONG/REC] button keeps lighting all the time, and the LCD will display "ING xxx", the "xxx" means measure number.
4. Press the [START/STOP] button again to stop recording, and the light of the [SONG/REC] button will be off.
5. The system returns to the last option automatically. The LCD will display "NUM 81~85". Press the [START/ STOP] button to play back the recorded song.

Note:

While the record storage capacity is full, the LCD will temporarily display "REC FUL", the recording stops automatically.

The UserKitxx shouldn't be changed if you use it to record, otherwise the record playback may not be correct.

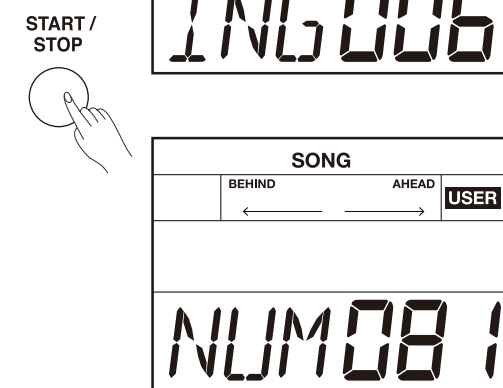
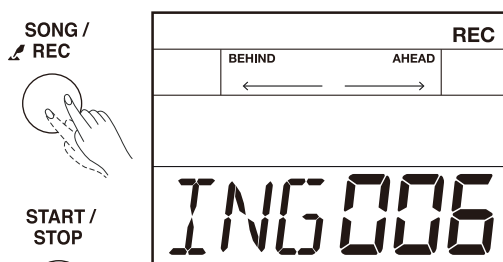
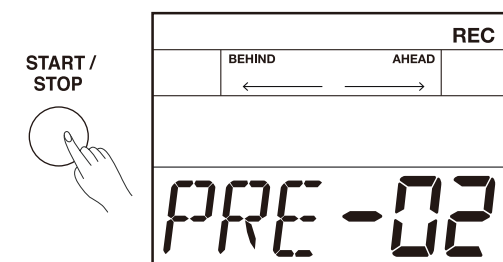
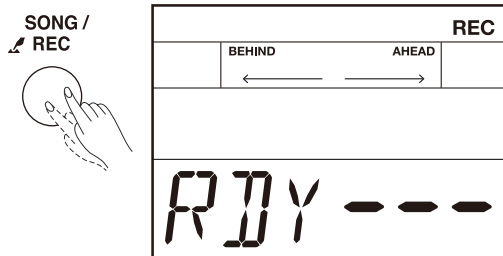

Coach

The Coach mode is a unique set of exercises. Specifically designed for those learners who want to build a better tempo, accuracy and stamina, as well as developing a better drum playing skills.

About Coach Mode

There are three types of exercises in Coach Mode: Quiet Count, Change Up and Beat Check. Each exercise has its special practicing characteristics. Automatic grading function is available for Change Up and Beat Check types. Try to get a perfect score of 100!

Coach Mode Control

1. Press the [COACH] button to enter coach mode. Then repeatedly press the [PAGE] button to shift coach type among Quiet Count, Change Up and Beat Check. In the meantime, you can set the accent beat prompt for MEA. According to your present playing skills, select an appropriate coach type to practice.

COACH

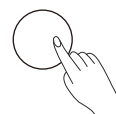

PAGE



Coach Type	Display	Description
Quiet Count	QUT CNT	This helps to develop a good sense of time/ tempo. There are 3 types of quiet mode and 5 selectable rhythm types.
Change Up	CHG UP	3 types of rhythm pattern to train your beat accuracy. The rhythm type will change every two measures.
Beat Check	BEA CHE	Only metronome accuracy practice. There are 13 selectable rhythm types.
Measure Hint	MEA	Turn on/off accent hint

2. Press the [SAVE/ ENTER] button to enter the selected coach type.
3. Use the [PAGE] button to select relevant parameters. Throughout the Coach modes, you will discover that some of them have programmable parameters, allowing you to adapt the functions to your specific needs.
4. Press the [TEMPO] button to adjust practice speed at any time.
5. Pay attention to the LCD indicators of hitting accuracy when you are practicing.

Note:

1. Set the automatic grading function to "ON", only playing with metronome guidance without bell.
2. Set the automatic grading function to "OFF", playing with conventional metronome sound with bell.

6. Press the [COACH] button to exit the Coach Mode.

QUT CNT (QUIET COUNT)

Practice with auto metronome on/ off circularly with several measures to help you develop a good sense of time and tempo.

1. Repeatedly press the [PAGE] button to select quiet count mode.
2. Press the [SAVE/ ENTER] button to enter quiet count mode.
3. Use the [PAGE] button switch between QUT and CNT parameters, press the [←]/[→] button or turn the [DIAL] to select a suitable quiet and count type.

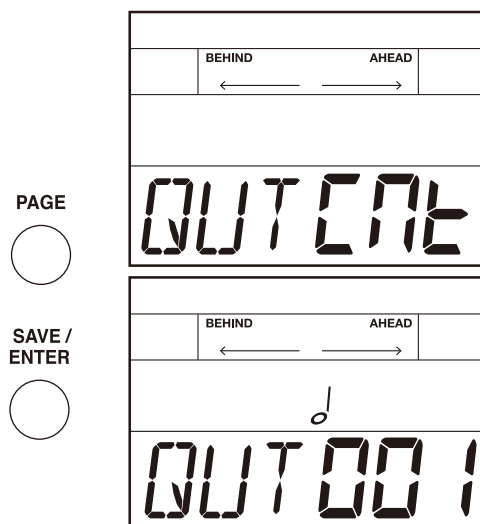
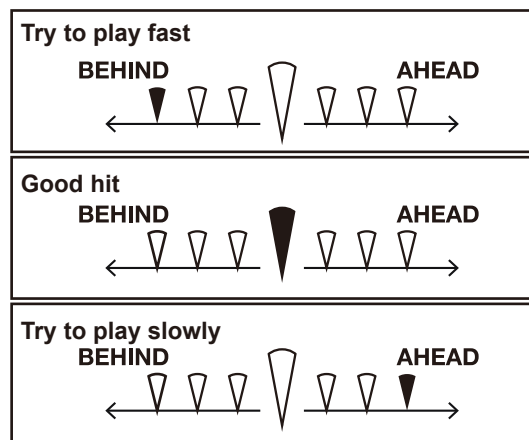

PAGE



SAVE / ENTER



Parameters	Range	Display	Description
QUT	1~5	QUT XXX	Use the [<]/ [>] button or turn the [DIAL] to select a suitable quiet type.
CNT	1-1/2-2/1-3	CNT XXX	Use the [<]/ [>] button or turn the [DIAL] to select a suitable count type. 1-1: 1 measure counts, 1 measure quiets. 2-2: 2 measure counts, 2 measure quiets. 1-3: 1 measure counts, 3 measure quiets.

- Press the [START/ STOP] button to start practicing.
There is a count-in about 1 measure length before starting. Metro nome sound automatic on/ off, you have to catch up with every beat you ought to play, come on!
- If you want to change another QUT/CNT parameter or just exit coach mode, Firstly, press the [START/ STOP] button again to stop practicing.

START / STOP



Change Up

In change up mode, system will automatic change the style every two measures. Starting from half notes, the note values will gradually become shorter, and will then return to half notes; this change in rhythms will be repeated. The icon on the LCD will flash for times when the rhythm type is ready to change.

- Repeatedly press the [PAGE] button to select change up mode.
- Press the [SAVE/ ENTER] button to enter change up mode.
- Use the [<]/[>] button or turn the [DIAL] to select a suitable rhythm pattern.
- Use the [PAGE] button to switch to score editing, press the [<]/[>] button or turn the [DIAL] to turn score function on/ off. The default score setting is "OFF".

PAGE



SAVE / ENTER

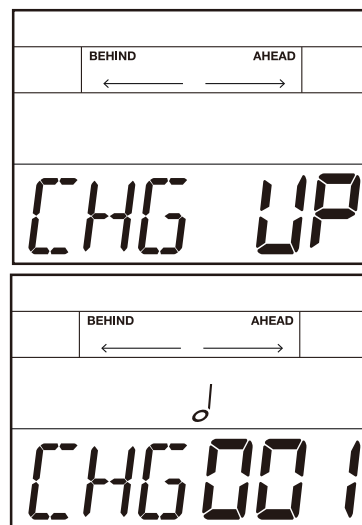

Chang Up	Range	Display	Description
CHG	1~3	CHG XXX	Use the [<]/[>] button or turn the [DIAL] to select a suitable rhythm type.
SCO	ON/ OFF	SCO XXX	ON: The score setting is on. OFF: The score setting is off.

Rhythm Pattern	Display	Description
P-1	CHG 001	
P-2	CHG 002	
P-3	CHG 003	

- Press the [START/ STOP] button to start practicing.
There will play a length of one measure count-in before starting. This system automatic change the style every two measures. In addition to, the next rhythm will flash for times on the LCD when the rhythm type is ready to change.
- If the score setting is "ON": Auto stops practicing and displays your score after circularly playing several times. Or, Press the [START/ STOP] button to stop practicing and back to the main page of change up without display your score.
If the score setting is "OFF": Press the [START/ STOP] button to stop the practicing mode.

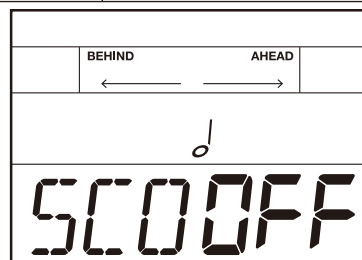

Coach

Beat Check

In order to improve playing accuracy of beat, practice with the metronome basic beat type. If the score function is on, system will display your practicing score after you have finished.

1. Repeatedly press the [PAGE] button to select beat check mode.
2. Press the [SAVE/ ENTER] button to enter beat check mode.
3. Use the [<]/[>] button or turn the [DIAL] to select a beat type to practice. There are 13 beat types to choose from.
4. Use the [PAGE] button to switch to score editing, press the [<]/[>] button or turn the [DIAL] to turn score function on/ off. The default score setting is "OFF".

Beat check	Range	Display	Description
BEA	1-13	BEA XXX	 Use the [<]/[>] button or turn the [DIAL] to select a suitable beat type.
SCO	ON, OFF	SCOXXX	ON: The score setting is on. OFF: The score setting is off.

5. Press the [START/ STOP] button to start practicing. There will play a length of one measure count-in before starting.
6. If the score setting is "ON": Auto stops practicing and displays your score after circularly playing several times. Or, Press the [START/ STOP] button to stop practicing and back to the main page of beat check without display your score. If the score setting is "OFF": Press the [START/ STOP] button to stop the practicing mode.

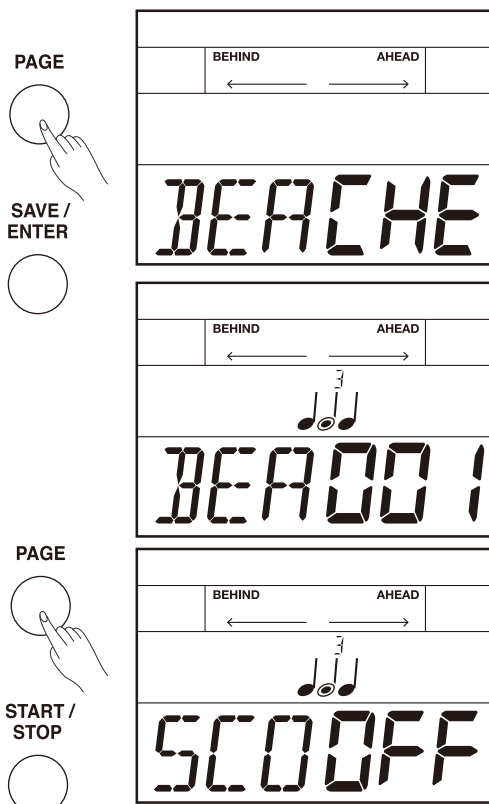

DBT (Double Bass Trigger)

Normally, it is too hard for beginners to play double bass, almost impossible, but we make it possible now. Turn on DBT function on; it can generate two or three continuous kick sounds when you step on the bass drum only once. Easy to achieve double bass pedal techniques.

Turn the DBT Function On

1. Press the [DBT] button to turn DBT function on. The [DBT] button lights up. The screen will display "DBT 1-x".
2. Use [<]/[>] or the [DIAL] to adjust the second trigger time. This setting can be remained even turn the module off.

Parameter	Range	Display	Description
BEA	1-1/1-2/ 1-3/1-4	DBT XXX	1. Press the [<]/[>] button or turn the [DIAL] to select a rhythm type. 2. 1=original beat, trigger once. 2=original beat/ 2, trigger once. 3=original beat/ 3, trigger twice. 4=original beat/ 4, trigger three times. 3. Power off protection. This setting can be remained even turn the module off.

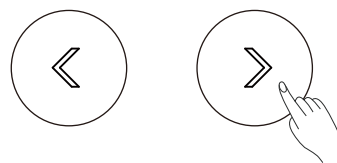
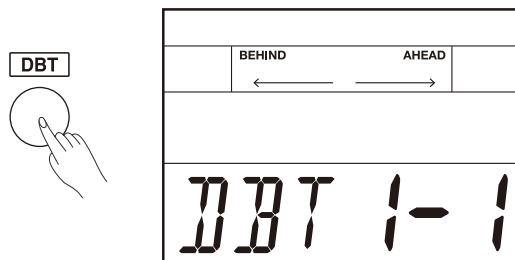

3. As you play the bass drum, it can produce a double bass technique.
4. Press the [DBT] button again, turn DBT function off.

Tempo

Press the [TEMPO] button to adjust the tempo value of metronome and song playback.

1. Press the [TEMPO] button.
2. Use the [<]/[>] button or the [DIAL] to adjust tempo value.
3. Without any operation within 3 seconds, the system will be back to previous menu automatically.

Parameter	Value	LCD Display	Description
Tempo	30-280	TMP xxx	Both metronome and song playback are based on this tempo value.

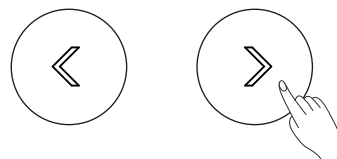
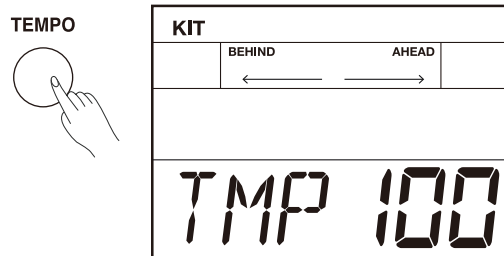

Utility Mode (UTILITY)

This mode contains two parts: the drum pad trigger settings and drum module settings.

The Drum Pad Trigger Settings

As a professional drummer, you may be very pleased to set your drum triggers carefully corresponding to your playing habits and feelings, making your performance more interesting and professional. At the meantime, your digital drum will be more operable.

1. Press the [UTILITY] button, the LCD will display the UTILITY menu.
2. Repeatedly press the [PAGE] button to select the trigger parameters that you want to edit.

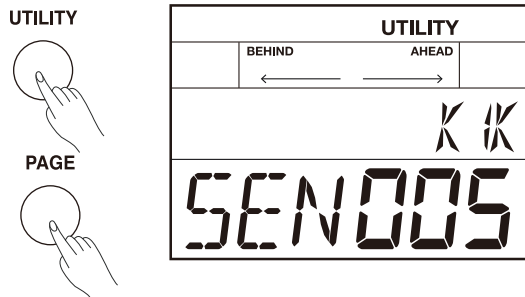

The drum pad trigger settings are shown below:

Parameter	Value	LCD Display	Description
SENSITIVITY	1~16	SEN XXX	You can adjust the sensitivity of the pads to accommodate your personal playing habit. Higher sensitivity allows the pad to produce a loud volume even when played softly. Lower sensitivity will keep the pad to producing a low volume even when played forcefully.
XTALK	1~8	XTK XXX	This setting avoids “crosstalk”, which means that when you play one pad you can hear a sound coming from another pad. This can happen when two pads are installed on the same stand. In some cases you can prevent crosstalk by increasing the distance between the two mounted pads. For example: If you hit the snare pad and the tom 1 also sounds. While striking the snare pad, gradually increase the “XTALK” value for the tom 1 pad until the tom 1 pad no longer sounds when you hit the snare pad. If you raise the “XTALK” higher, the tom 1 pad will be less prone to receive crosstalk from other pads. Note: If the value is set too high, and two pads are played simultaneously, the one that is struck less forcefully may not sound. Be careful and set this parameter to the minimum value required to prevent crosstalk.
CURVE	1~6	CUR XXX	This setting allows you to control the relation between playing velocity (striking force) and changes in volume. Adjust this curve until the response feels as natural as possible. Refer to the CURVE description.
RETRIG CANCEL	1~16	RTG XXX	This setting avoids “re-triggering”, which means that when you strike a pad once, maybe you can hear two hits coming from one strike. This can happen as the pad oscillate. While repeatedly striking the pad, raise the “Retrig Cancel” value until re-triggering no longer occurs. Although setting this to a high value prevents re-triggering, it then becomes easy for sounds to be omitted when the drums played fast (roll etc.). Set this to the lowest value possible while still ensuring that there is no re-triggering.
MIDI NOTE	0~127	MID XXX	MIDI output key mapping

3. Striking the specified pad, select the pad that you want to edit.
4. Use the [<]/[>] button or the [DIAL] to adjust the parameter value.

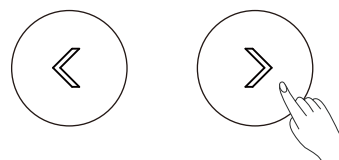

Utility Mode (UTILITY)

Note:

The Curve descriptions are shown below:

Curve 1: The standard setting. This produces the most natural correspondence between playing dynamics and volume change.

Curve 2, 3: Compared to Curve 1, strong dynamics produce a greater change.

Curve 4, 5: Compared to Curve 1, a soft playing produces a greater change.

Curve 6: Very little dynamic response, making it easy to maintain strong volume levels. If you are using a drum trigger as an external pad, these settings will produce reliable triggering.

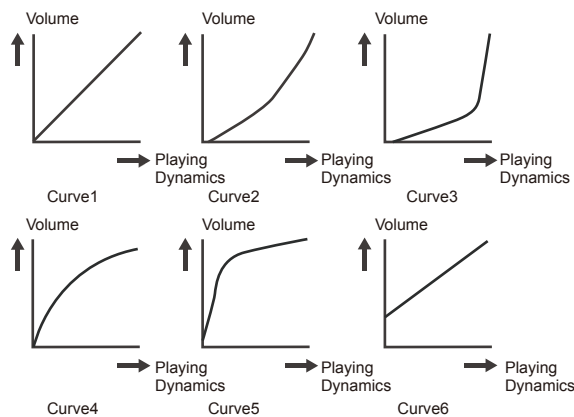

Default Midi Note :

Trigger	MIDI	Trigger	MIDI
Kick	36	Ride Bow	51
Snare Head	38	Crash1 Bow	49
Snare Rim	40	Crash2 Bow	57
Tom1 Head	48	Open Hihat	46
Tom2 Head	45	Close Hihat	42
Tom3 Head	43	Pedal	44
Tom4 Head	41	Hihat Splash	21

The Drum Module Settings

You can go further set the drum module function, do as the procedures shown below:

1. Press the [UTILITY] button, the LCD will display the UTILITY menu.
2. You can repeatedly press the [PAGE] button to select the function menu and use the [<|>] button or the [DIAL] to adjust the parameter value.

The setting values of drum module are shown below:

Parameter	Range	LCD Display	Description
GM MODE	ON/OFF	GM XXX	ON: The channel 10 will respond GM drum kit. OFF: The channel 10 will respond local drum kit.
AUTO POWER	30, 60 ,OFF	POW XXX	Factory settings, approximately 30 minutes. 30: Automatically turns the power off if no buttons or functions are operated for approximately 30 minutes. 60: Automatically turns the power off if no buttons or functions are operated for approximately 60 minutes. OFF: The power will not power off automatically.

UTILITY



PAGE

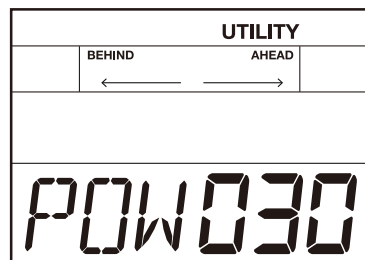
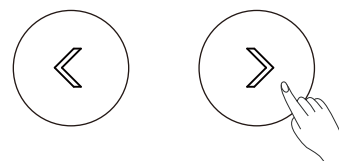
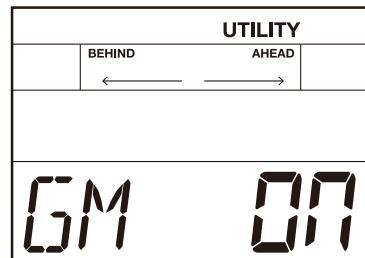

Troubleshooting

Problem	Possible Cause and Solution
No sound	<ol style="list-style-type: none"> 1. Rotate the [VOLUME] knob to be sure that the volume isn't down. 2. To be sure that Local Mode should be set to "ON"
No sound from Pads	<ol style="list-style-type: none"> 1. To be sure that the pad is connected correctly. 2. To be sure not set the volume of the pad to 0.
No click sound	<ol style="list-style-type: none"> 1. To be sure the metronome is turned on. 2. To be sure not set the volume of the click to 0.
The Pad volume doesn't match the Song playback volume.	<ol style="list-style-type: none"> 1. Adjust the song playback volume to match the pad volume.
Cannot connect to the computer	<ol style="list-style-type: none"> 1. Make sure the USB has correctly connected. 2. Do the connect operation again (Keep the computer on, and then turn the module on, connect the USB cable).

Prompt Messages

Message	Meaning
REC FUL	The record data memory is full.
FAC SET	The factory reset of module is complete.
EMP	The user song is empty.
OK	The drum kit and utility settings are saved.
WAT	The data is loading from flash ROM now, please wait.

Specifications

Maximum Polyphony

64

Drum kits

Kit: 40 (30 Presets + 10 Users)
GM Drum Kit: 11 GM Drum Kits

Instruments

Instrument: 408 + 10 Hi-hat Combination

Sequencer

Preset Pattern: 80
User Song: 5
Tick: 192 ticks per beat
Record: Real-time Record
Data Capacity: About 2500 notes

Tempo

30~280

Display

Backlit LCD

Connectors

TRIGGER INPUT Connector(DB25), PHONES, LINE OUT (R, L/MONO), TOM4, CRASH2, MIDI OUT, AUX IN, USB-MIDI

Control Buttons

Power on/off, Master Volume, Click, Kit/ Voice, Save/ Enter, Drum Off, DBT, Coach, Song/ Rec, Start/Stop, Utility, Tempo, +/-, Page, Dial.

Power Supply

DC 9V, 500mA

Dimensions

125(W) X 187.5 (L) X 95 (H) mm

Module Weight

0.5 kg

* All specifications and appearances are subject to change without notice.

Drum Kit List

No.	PRESET KIT
1	Acoustic 1
2	Funk Band
3	Standard 1
4	Jazz Brush
5	Dacne
6	Rock
7	Jazz
8	808
9	909
10	Funk
11	FX Mix
12	Power
13	Latin
14	Room
15	Marimba

No.	PRESET KIT
16	Percussion 1
17	90's Power
18	Indian
19	African
20	Electronic
21	Reggae
22	Fusion
23	Brush
24	Orchestra
25	HipHop
26	Big Band
27	Live
28	House
29	Techno
30	Vintage

Drum Voice List

No.	NAME
KICK	
1	22" Acoustic Kick 1
2	22" Acoustic Kick 2
3	24" Standard Kick
4	Brush Kick 1
5	Brush Kick 2
6	Jazz Kick
7	22" Rock Kick
8	Room Kick
9	Fusion Kick
10	1970's Kick
11	Vintage Kick
12	HipHop Kick
13	Reggae Kick
14	808 Kick
15	909 Kick
16	Electronic Kick
17	Power Kick
18	Dance Kick
19	FX Mix Kick
20	Techno Kick
SNARE	
21	14" Acoustic Snare
22	14" Acoustic Snare Rim
23	14" Standard Snare
24	14" Standard Snare Rim
25	14" Funk Snare 1
26	14" Funk Snare Rim 1
27	14" Funk Snare 2
28	14" Funk Snare Rim 2
29	Brush Snare 1
30	Brush Snare Rim 1
31	Brush Snare 2
32	Brush Snare Rim 2
33	14" Jazz Snare
34	14" Jazz Snare Rim
35	14" Rock Snare
36	14" Rock Snare Rim
37	13" Damped Snare 1
38	13" Damped Snare 2
39	13" Damped Snare 3
40	Orchestra Snare
41	Orchestra Snare Rim
42	Room Snare
43	Room Snare Rim
44	Fusion Snare
45	Fusion Snare Rim
46	Big Band Snare
47	Big Band Snare Rim
48	Vintage Snare
49	Vintage Snare Rim
50	Live Snare
51	Live Snare Rim

52	Reggae Snare
53	Reggae Snare Rim
54	R&B Snare
55	R&B Snare Rim
56	808 Snare
57	808 Snare Rim
58	909 Snare
59	909 Snare Rim
60	Electronic Snare
61	Power Snare
62	Dance Snare
63	Dance Snare Rim
64	House Snare
65	House Snare Rim
66	Lo-Fi Snare
67	Lo-Fi Snare Rim
68	Techno Snare
69	Techno Snare Rim
70	Acoustic Snare Stick
71	Standard Snare Stick 1
72	Brush Snare Stick
73	Standard Snare Stick 2
74	Rock Snare Stick 1
75	Rock Snare Stick 2
76	Live Snare Stick
77	Room Snare Stick
78	Fusion Snare Stick
79	808 Snare Stick
80	909 Snare Stick
81	Electronic Snare Stick
82	House Snare Stick
83	Lo-Fi Snare Stick
84	Techno Snare Stick
85	Brush Swirl
TOM	
86	Acoustic Tom 1
87	Acoustic Tom 1 Rim
88	Acoustic Tom 2
89	Acoustic Tom 2 Rim
90	Acoustic Tom 3
91	Acoustic Tom 3 Rim
92	Acoustic Tom 4
93	Acoustic Tom 4 Rim
94	Acoustic Tom 5
95	Acoustic Tom 5 Rim
96	Acoustic Tom 6
97	Acoustic Tom 6 Rim
98	Brush Tom 1
99	Brush Tom 1 Rim
100	Brush Tom 2
101	Brush Tom 2 Rim
102	Brush Tom 3
103	Brush Tom 3 Rim
104	Brush Tom 4

105	Brush Tom 4 Rim
106	Brush Tom 5
107	Brush Tom 5 Rim
108	Brush Tom 6
109	Brush Tom 6 Rim
110	Funk Tom 1
111	Funk Tom 1 Rim
112	Funk Tom 2
113	Funk Tom 2 Rim
114	Funk Tom 3
115	Funk Tom 3 Rim
116	Funk Tom 4
117	Funk Tom 4 R
118	Funk Tom 5
119	Funk Tom 5 Rim
120	Funk Tom 6
121	Funk Tom 6 Rim
122	Jazz Tom 1
123	Jazz Tom 1 Rim
124	Jazz Tom 2
125	Jazz Tom 2 Rim
126	Jazz Tom 3
127	Jazz Tom 3 Rim
128	Jazz Tom 4
129	Jazz Tom 4 Rim
130	Jazz Tom 5
131	Jazz Tom 5 Rim
132	Jazz Tom 6
133	Jazz Tom 6 Rim
134	Fusion Tom 1
135	Fusion Tom 2
136	Fusion Tom 3
137	Fusion Tom 4
138	808 Tom 1
139	808 Tom 2
140	808 Tom 3
141	808 Tom 4
142	808 Tom 5
143	808 Tom 6
144	808 Tom Fx 1
145	808 Tom Fx 2
146	909 Tom 1
147	909 Tom 2
148	909 Tom 3
149	909 Tom 4
150	909 Tom 5
151	909 Tom 6
152	909 Tom 7
153	909 Tom 8
154	Electronic Tom 1
155	Electronic Tom 2
156	Electronic Tom 3
157	Electronic Tom 4
158	Electronic Tom 5

Drum Voice List

159	Electronic Tom 6
160	Electronic Tom 7
161	Electronic Tom 8
162	Power Tom 1
163	Power Tom 2
164	Power Tom 3
165	Power Tom 4
166	Power Tom 5
167	Power Tom 6
168	90's Power Tom 1
169	90's Power Tom 2
170	90's Power Tom 3
171	90's Power Tom 4
172	90's Power Tom 5
173	90's Power Tom 6
174	Techno Tom 1
175	Techno Tom 1 Rim
176	Techno Tom 2
177	Techno Tom 2 Rim
178	Techno Tom 3
179	Techno Tom 3 Rim
180	Techno Tom 4
181	Techno Tom 4 Rim
182	Techno Tom 5
183	Techno Tom 5 Rim
184	Techno Tom 6
185	Techno Tom 6 Rim
SNARE	
186	21" Acoustic Ride
187	21" Acoustic Ride Edge
188	21" Acoustic Ride Bell
189	Brush Ride 1
190	Brush Ride 2
191	20" Funk Ride
192	20" Funk Ride Edge
193	20" Funk Ride Bell
194	20" Rock Ride
195	20" Rock Ride Edge
196	20" Rock Ride Bell
197	808 Ride
198	20" Room Ride
199	20" Room Ride Edge
200	20" Room Ride Bell
201	House Ride
202	House Ride Edge
203	House Ride Bell
204	Lo-Fi Ride
205	Lo-Fi Ride Edge
206	Lo-Fi Ride Bell
207	Junkyard Ride
208	Junkyard Ride Edge
209	Junkyard Ride Bell
CRASH	
210	16" Acoustic Crash 1

211	16" Acoustic Crash 1 Edge
212	16" Acoustic Crash 2
213	16" Acoustic Crash 2 Edge
214	16" Standard Crash 1
215	16" Standard Crash 1 Edge
216	16" Standard Crash 2
217	16" Standard Crash 2 Edge
218	Brush Crash 1
219	Brush Crash 2
220	Brush Crash 3
221	Brush Crash 4
222	Funk Crash 1
223	Funk Crash 1 Edge
224	Funk Crash 2
225	Funk Crash 2 Edge
226	19" Jazz Crash 1
227	19" Jazz Crash 1 Edge
228	19" Jazz Crash 2
229	19" Jazz Crash 2 Edge
230	Rock Crash 1
231	Rock Crash 1 Edge
232	Rock Crash 2
233	Rock Crash 2 Edge
234	808Crash
235	909Crash 1
236	909Crash 2
237	Electronic Crash 1
238	Electronic Crash 2
239	Orchestra Crash 1
240	Orchestra Crash 2
241	Orchestra Crash 3
242	Room Crash
243	Room Crash Edge
244	1970's Crash 1
245	1970's Crash 2
246	Vintage Crash 1
247	Vintage Crash 1 Edge
248	Vintage Crash 2
249	Vintage Crash 2 Edge
250	Big Band Crash 1
251	Big Band Crash 1 Edge
252	Big Band Crash 2
253	Big Band Crash 2 Edge
254	Techno Crash 1
255	Techno Crash 1 Edge
256	Techno Crash 2
257	Techno Crash 2 Edge
258	Latin Crash 1
259	Latin Crash 1 Edge
260	Latin Crash 2
261	Latin Crash 2 Edge
262	China 1
263	China 1 Edge
264	Splash

265	Splash Edge
HIHAT	
266	14" Acoustic Hi-hat
267	14" Acoustic Hi-hat Edge
268	14" Acoustic Hi-hat Pedal
269	14" Acoustic Hi-hat Splash
270	14" Standard Hi-hat
271	14" Standard Hi-hat Edge
272	14" Standard Hi-hat Pedal
273	14" Standard Hi-hat Splash
274	Brush Hi-hat
275	Brush Hi-hat Pedal
276	Brush Hi-hat Splash
277	14" Rock Hi-hat
278	14" Rock Hi-hat Edge
279	14" Rock Hi-hat Pedal
280	14" Rock Hi-hat Splash
281	808 Hi-hat
282	808 Hi-hat Pedal
283	808 Hi-hat Splash
284	909 Hi-hat
285	909 Hi-hat Pedal
286	909 Hi-hat Splash
287	Dance Hi-hat
288	Dance Hi-hat Pedal
289	Dance Hi-hat Splash
PERCUSSION	
290	Maracas
291	Metronome Bell
292	Vibra-slap 1
293	Vibra-slap 2
294	Vibra-slap 3
295	Synthesis Percussion 1
296	Synthesis Percussion 2
297	High Q 1
298	High Q 2
299	Low Q 1
300	Low Q 2
301	Mute Hi Conga 1
302	Mute Hi Conga 2
303	Open Hi Conga 1
304	Open Hi Conga 2
305	Low Conga
306	High Bongo
307	Low Bongo
308	High Timbale 1
309	High Timbale 1 Rim
310	High Timbale 2
311	High Timbale 2 Rim
312	Low Timbale 1
313	Low Timbale 2
314	Low Timbale 2 Rim
315	Low Timbale 3
316	Low Timbale 4

Drum Voice List

317	High Agogo
318	Low Agogo
319	Claves
320	Jingle Bell
321	Cowbell
322	Bell Tree 1
323	Bell Tree 2
324	Tambourine
325	Cabasa
326	Long Guiro
327	Short Guiro
328	Indian 1
329	Indian 2
330	Indian 3
331	Indian 4
332	Indian 5
333	Indian 6
334	Indian 7
335	Indian 8
336	Indian 9
337	Indian 10
338	Indian 11
339	Indian 12
340	Indian 13
341	Indian 14
342	Indian 15
343	Indian 16
344	Indian 17
345	African 1
346	African 2
347	African 3
348	African 4
349	African 5
350	African 6
351	African 7
352	African 8
353	African 9
354	African 10
355	African 11
356	African 12
357	African 13
358	African 14
359	African 15
360	African 16
361	African 17
362	Marimba C3
363	Marimba C4
364	Marimba D4
365	Marimba E4
366	Marimba F4
367	Marimba G4
368	Marimba A4
369	Marimba B4
370	Marimba C5

371	Marimba D5
372	Marimba E5
373	Marimba F5
374	Marimba G5
375	Marimba A5
376	Marimba B5
377	Marimba C6
378	Orchestra Timp E2
379	Orchestra Timp F2
380	Orchestra Timp Gb2
381	Orchestra Timp G2
382	Orchestra Timp Ab2
383	Orchestra Timp A2
384	Orchestra Timp Bb2
385	Orchestra Timp B2
386	Orchestra Timp C3
FX	
387	FX 1
388	FX 2
389	FX 3
390	FX 4
391	FX 5
392	FX 6
393	FX 7
394	FX 8
395	FX 9
396	FX 10
397	FX 11
398	FX 12
399	FX 13
400	FX 14
401	FX 15
402	FX 16
403	FX 17
404	FX 18
405	FX 19
406	FX 20
407	FX 21
408	Mute
HIHAT COMBINATION	
409	Acoustic
410	Standard
411	JazBrush
412	Rock
413	808
414	909
415	Dance
416	Marimba
417	Indian
418	African

Song List

No.	Name
1	Funk1
2	Rock N'Roll1
3	Dance1
4	Pop1
5	Fusion1
6	R&B1
7	BritPop
8	R&B2
9	GtrBossa
10	Rock Ballad
11	Folk
12	Funk Shuffle
13	Ele Pop1
14	Pop2
15	Bossa Nova1
16	Samba1
17	Fusion2
18	Ele Pop2
19	Pop Shuffle
20	Rock1
21	Latin1
22	Latin2
23	Salsa1
24	Smoove
25	Steve Vai Funk
26	70's Funk
27	Jazz1
28	6/8Soul1
29	Fusion2
30	Dance funk
31	Dance2
32	DJ.House
33	Ele Pop3
34	Hip Hop
35	Pop3
36	Pop4
37	R&B3
38	Reggae1
39	Rock2
40	Rock3
41	Blues Funk
42	Fusion3
43	Cool Jazz
44	Ballad
45	Samba2
46	Vintage Hip-Hop
47	Nu Jazz Funk
48	Soul
49	R&B4
50	Big Band 1

51	Ska
52	Classic Rock
53	Hardcore Hip-Hop
54	Vintage Dance Pop
55	Nu-Metal
56	Salsa2
57	Eu Hip-Hop
58	Bossa Nova2
59	Fusion 4
60	8Beat Pop
61	Jazzy Funk
62	Swing Big Band
63	Reggae 1
64	60's Pop
65	Vintage Funk
66	Trance
67	Heavy Rock
68	Swing
69	Punk
70	8Beat
71	Disco House
72	3/4 Folk
73	Samba3
74	Latin Rock
75	Reggae 2
76	Dance3
77	Country Pop
78	Country
79	PopRock
80	DancePop

GM Drum Kit List

Note No.	Standard (bank 00)	Funk (bank 08)	Rock (bank 16)	Electric (bank 24)	Analog (bank 25)
Eb1[27]	High Q				
E 1[28]	Slap				
F 1[29]	Scratch Push				
F#1[30]	Scratch Pull				
G 1[31]	Sticks				
G#1[32]	Square Click				
A 1[33]	Metronome Click				
Bb1[34]	Metronome Bell				
B 1[35]	Acoustic Bass Drum				
C 2[36]	Bass Drum 1	Funk Kick	Rock Kick Drum	Electric Bass Drum	Analog Bass Drum
C#2[37]	Side Stick				Analog Rim Shot
D 2[38]	Acoustic Snare	Funk Snare 1	Rock Snare Drum1	Electric Snare 1	Analog Snare 1
Eb2[39]	Hand Clap				Analog Clap
E 2[40]	Electric Snare	Funk Snare 2	Rock Snare Drum2	Electric Snare 2	Analog Snare 2
F 2[41]	Low Floor Tom	Funk LowTom2	Rock LowTom2	Electric Low Tom 2	Analog Low Tom2
F#2[42]	Closed Hi-hat				Analog Closed Hi-hat
G 2[43]	High Floor Tom	Funk LowTom1	Rock LowTom1	Electric Low Tom 1	Analog Low Tom1
G#2[44]	Pedal Hi-hat				Analog Pedal Hi-hat
A 2[45]	Low Tom	Funk MidTom2	Rock MidTom2	Electric Mid Tom 2	Analog Mid Tom2
Bb2[46]	Open Hi-hat				Analog Open Hi-hat
B 2[47]	Low-Mid Tom	Funk MidTom1	Rock MidTom1	Electric Mid Tom 1	Analog Mid Tom1
C 3[48]	High Mid Tom	Funk Hi Tom2	Rock HiTom2	Electric Hi Tom 2	Analog Hi Tom2
C#3[49]	Crash Cymbal 1				Analog Cymbal
D 3[50]	High Tom 1	Funk Hi Tom1	Rock HiTom1		Analog Hi Tom1
Eb3[51]	Ride Cymbal 1				
E 3[52]	China Cymbal				
F 3[53]	Ride Bell				
F#3[54]	Tambourine				
G 3[55]	Splash Cymbal				
G#3[56]	Cowbell				
A 3[57]	Crash Cymbal 2				
Bb3[58]	Vibra-slap				
B 3[59]	Ride Cymbal 2				
C 4[60]	High Bongo				
C#4[61]	Low Bongo				
D 4[62]	Mute Hi Conga				
Eb4[63]	Open Hi Conga				
E 4[64]	Low Conga				
F 4[65]	High Timbale				
F#4[66]	Low Timbale				
G 4[67]	High Agogo				
G#4[68]	Low Agogo				
A 4[69]	Cabasa				
Bb4[70]	Maracas				
B 4[71]	Short Whistle				
C 5[72]	Long Whistle				
C#5[73]	Short Guiro				
D 5[74]	Long Guiro				
Eb5[75]	Claves				
E 5[76]	Hi Wood Block				
F 5[77]	LowWood Block				
F#5[78]	Mute Cuica				
G 5[79]	Open Cuica				
G#5[80]	Mute Triangle				
A 5[81]	Open Triangle				
Bb5[82]	Shaker				
B 5[83]	Jingle Bell				
C 6[84]	Bell Tree				
C#6[85]	Castanets				
D 6[86]	Mute Surdo				
Eb6[87]	Open Surdo				

GM Drum Kit List

Note No.	Jazz (bank 32)	Brush (bank 40)	Orchestra (bank 48)	Dance (bank 56)
Eb1[27]			Closed Hi-hat 2	
E 1[28]			Pedal Hi-hat	
F 1[29]			Open Hi-hat 2	
F#1[30]			Ride Cymbal 1	
G 1[31]				
G#1[32]				
A 1[33]				
Bb1[34]				
B 1[35]			Concert BD 2	
C 2[36]	Jazz Kick 1	Brush Kick 1	Concert BD 1	Dance Bass Drum
C#2[37]				
D 2[38]	Jazz Snare 1	Brush Tap	Concert SD	Dance Snare 1
Eb2[39]			Castanets	
E 2[40]	Jazz Snare 2	Brush Slap	Concert SD	Dance Snare 2
F 2[41]		Brush Low Tom2	Timpani F	Dance Low Tom2
F#2[42]			Timpani F#	Dance Closed
G 2[43]		Brush Low Tom1	Timpani G	Hi-hat
G#2[44]			Timpani G#	Dance Low Tom1
A 2[45]		Brush Mid Tom2	Timpani A	Dance Pedal Hi-hat
Bb2[46]			Timpani A#	Dance Mid Tom2
B 2[47]		Brush Mid Tom1	Timpani B	Dance Open Hi-hat
C 3[48]		Brush Hi Tom2	Timpani c	Dance Mid Tom1
C#3[49]			Timpani c#	Dance Hi Tom2
D 3[50]		Brush Hi Tom1	Timpani d	Dance Cymbal
Eb3[51]			Timpani d#	Dance Hi Tom1
E 3[52]			Timpani e	
F 3[53]			Timpani f	
F#3[54]				
G 3[55]				
G#3[56]				
A 3[57]				
Bb3[58]				
B 3[59]				
C 4[60]				
C#4[61]				
D 4[62]				
Eb4[63]				
E 4[64]				
F 4[65]				
F#4[66]				
G 4[67]				
G#4[68]				
A 4[69]				
Bb4[70]				
B 4[71]				
C 5[72]				
C#5[73]				
D 5[74]				
Eb5[75]				
E 5[76]				
F 5[77]				
F#5[78]				
G 5[79]				
G#5[80]				
A 5[81]				
Bb5[82]				
B 5[83]				
C 6[84]				
C#6[85]				
D 6[86]				
Eb6[87]				

GM Backing Instrument List

PIANO		STRINGS		LEAD	
1	Acoustic Grand Piano	41	Violin	81	Lead1 (square)
2	Bright Acoustic Piano	42	Viola	82	Lead2 (sawtooth)
3	Electric Grand Piano	43	Cello	83	Lead3 (calliope)
4	Honky-Tonk Piano	44	Contrabass	84	Lead4 (cliff)
5	E.Piano 1	45	Tremolo Strings	85	Lead5 (charang)
6	E.Piano 2	46	Pizzicato Strings	86	Lead6 (voice)
7	Harpsichord	47	Orchestral Harp	87	Lead7 (fifths)
8	Clavi	48	Timpani	88	Lead8 (bass & lead)
MALLET		STRINGSENSEMBLE		PAD	
9	Celesta	49	Strings Ensemble 1	89	Pad1 (newage)
10	Glockenspiel	50	Strings Ensemble 2	90	Pad2 (warm)
11	Music Box	51	Synth Strings 1	91	Pad3 (polysynth)
12	Vibraphone	52	Synth Strings 2	92	Pad4 (choir)
13	Marimba	53	Choir Aahs	93	Pad5 (bowed)
14	Xylophone	54	Voice Oohs	94	Pad6 (metallic)
15	Tubular Bells	55	Synth Voice	95	Pad7 (halo)
16	Dulcimer	56	Orchestra Hit	96	Pad8 (sweep)
ORGAN		BRASS		EFFECTS	
17	Drawbar Organ	57	Trumpet	97	FX1 (rain)
18	Percussive Organ	58	Trombone	98	FX2 (soundtrack)
19	Rock Organ	59	Tuba	99	FX3 (crystal)
20	Church Organ	60	Muted Trumpet	100	FX4 (atmosphere)
21	Reed Organ	61	French Horn	101	FX5 (brightness)
22	Accordion	62	Brass Section	102	FX6 (goblins)
23	Harmonica	63	Synth Brass 1	103	FX7 (echoes)
24	Tango Accordion	64	Synth Brass 2	104	FX8 (sci-fi)
GUITAR		REED		ETHNIC	
25	Nylon Guitar	65	Soprano Sax	105	Sitar
26	Steel Guitar	66	Alto Sax	106	Banjo
27	Jazz Guitar	67	Tenor Sax	107	Shamisen
28	Clean Guitar	68	Baritone Sax	108	Koto
29	Muted Guitar	69	Oboe	109	Kalimba
30	Overdriven Guitar	70	English Horn	110	Bagpipe
31	Distortion Guitar	71	Bassoon	111	Fiddle
32	Guitar Harmonics	72	Clarinet	112	Shanai
BASS		PIPE		PERCUSSIVE	
33	Acoustic Bass	73	Piccolo	113	Tinkle Bell
34	Finger Bass	74	Flute	114	Agogo
35	Pick Bass	75	Recorder	115	Steel Drums
36	Fretless Bass	76	Pan Flute	116	Wood Block
37	Slap Bass 1	77	Blown Bottle	117	Taiko Drum
38	Slap Bass 2	78	Shakuhachi	118	Melodic Tom
39	Synth Bass 1	79	Whistle	119	Synth Drum
40	Synth Bass 2	80	Ocarina	120	Reverse Cymbal
SOUNDEFFECTS					
121	Guitar Fret Noise				
122	Breath Noise				
123	Seashore				
124	Bird Tweet				
125	Telephone Ring				
126	Helicopter				
127	Applause				
128	Gunshot				

MIDI Implementation Chart

Function	Transmitted	Recognized	Remarks
Basic Default	10ch	1-16	
Channel Changed	x	x	
Mode Default	x	x	
Mode Messages	x	x	
Mode Altered	*****	*****	
Note Number : True Voice	0-127 *****	0-127 0-127	
Velocity Note On	○ 99H,V=1-127	○	
Velocity Note Off	○ (99H,V=0)	○	
after Key's	x	○	
Touch Ch's	x	x	
Pitch Bend	x	○	
Control Change 0	x	○	Bank Select
Control Change 1	x	○	Modulation
Control Change 5	x	○	Portamento Time
Control Change 6	x	○	Data Entry
Control Change 7	x	○	Volume
Control Change 10	x	○	Pan
Control Change 11	x	○	Expression
Control Change 64	x	○	Sustain Pedal
Control Change 65	x	○	Portamento On/Off
Control Change 66	x	○	Sostenuto Pedal
Control Change 67	x	○	Soft Pedal
Control Change 80	x	○	Reverb Program
Control Change 81	x	○	Chorus Program
Control Change 91	x	○	Reverb Level
Control Change 93	x	○	Chorus Level
Control Change 120	x	○	All Sound Off
Control Change 121	x	○	Reset All Controllers
Control Change 123	x	○	All Notes Off
Program Change : True Number	x	○	
System Exclusive	x	○	
System : Song Position	x	x	
Common : Song Select	x	x	
Common : Tune	x	x	
System : Clock	○	x	
Real Time : Commands	○	x	Start And Stop Only
Aux : Local On/off	x	x	
Aux : All Notes Off	x	x	
Messages : Active Sensing	x	x	
Messages : Reset	x	x	

○: YES x: NO

