

Quantum 4848

Ultra-low latency Thunderbolt™ Audio Interface

Owner's Manual



Table of Contents

1 Overview — 1

- 1.1 Introduction — 1
- 1.2 Product Registration — 1
- 1.2 What is in the Box — 2
- 1.3 What's in your My PreSonus Account — 2
- 1.4 Companion PreSonus Products — 3

2 Hookup — 4

- 2.1 Front Panel Indicators — 4
- 2.2 Back Panel Connections — 5
- 2.3 Quantum 4848 Hookup Diagram — 7

3 Connecting to a Computer — 8

- 3.1 Installation for Windows and macOS — 8
- 3.2 Using a Quantum Interface with Popular Audio Applications — 8

4 Universal Control and UC Surface — 10

- 4.1 Firmware Updates — 10
- 4.2 Universal Control Launch Window — 10
- 4.3 Metering — 12
- 4.4 RTA — 12

5 Aggregating Devices — 14

- 5.1 macOS — 14
- 5.2 Windows — 16

6 Studio One Professional Quick Start — 18

- 6.1 Installation and Authorization — 18
- 6.2 Setting Up Studio One — 19
 - 6.2.1 Configuring Audio Devices — 20
 - 6.2.2 Configuring MIDI Devices — 20

6.3 Creating a New Song — 23

- 6.3.1 Configuring Your I/O — 24
- 6.3.2 Creating Audio and MIDI Tracks — 25
- 6.3.3 Recording an Audio Track — 27
- 6.3.4 Adding Virtual Instruments and Effects — 27

6.4 Optimizing Latency and Performance — 29

- 6.4.1 Device Block Size — 29
- 6.4.2 Audio Dropout Protection — 29
- 6.4.3 Plug-in Use with Native Low-Latency Monitoring — 30

6.5 Monitor Mixing in Studio One — 30

- 6.5.1 Cue Mix Functions — 31
- 6.5.2 Punching In — 32

6.6 Pipeline XT — 33

7 Technical Information — 35

7.1 Specifications — 35

8 Warranty Information — 36

8.1 How Consumer Law Relates To This Warranty — 36

1 Overview

1.1 Introduction



Thank you for purchasing a PreSonus Quantum 4848 Thunderbolt Audio Interface. PreSonus Audio Electronics has designed the Quantum 4848 for the recording professional. Route audio from your vintage gear to your DAW and back without any signal degradation, capturing every nuance of your favorite boutique equipment at extremely low latency thanks to our custom Thunderbolt drivers.

We encourage you to contact us with questions or comments regarding your PreSonus Quantum 4848 interface. PreSonus Audio Electronics is committed to constant product improvement, and we highly value your suggestions. We believe the best way to achieve our goal of constant product improvement is by listening to the real experts: our valued customers. We appreciate the support you have shown us through the purchase of this product and are confident that you will enjoy your Quantum 4848 interface!

About this manual: We suggest that you use this manual to familiarize yourself with the features, applications, and correct connection procedures for your Quantum 4848 interface before trying to connect it to your computer. This will help you avoid problems during installation and setup.



Throughout this manual you will find **Power User Tips** that can quickly make you a Quantum-series interface expert. In addition to the Power User Tips, you will find tutorials on Studio One Professional and Pipeline. These tutorials are designed to get you up and running with the included professional software suite as quickly as possible.

1.2 Product Registration

PreSonus is committed to delivering the best experience for our customers. My PreSonus is a one-stop portal for all our registered customers' needs. From your My PreSonus account, you can view all your PreSonus hardware and software registrations; download drivers, installers, and content; contact support; track orders and more.

To register your Quantum 4848

Don't have a My.PreSonus account yet?
Here's why you should sign up.

-  One account gets you everything you need, from support to forums to product info and upgrades. Get the inside track on training videos, tutorials, special offers, and advance notifications.
-  Register a product on My.PreSonus and you're eligible for technical support, timely updates, expedited warranty service and quick tracking should you ever need repair. You also get special promotions that are 'members only'!
-  Join the ever-growing community of PreSonus users and share ideas, projects, and yes, gripes on our forum and blogs. It's a lively, Cajun-tinged vibe and it's waiting for you.

[Create My.PreSonus Account](#)

Go to My.PreSonus.com and follow the onscreen instructions.

–OR–



Download the MyPreSonus app from the Apple App Store or Google Play.

1.2 What is in the Box

You Quantum-series interface package contains the following:



PreSonus Quantum 4848 Thunderbolt Audio Interface

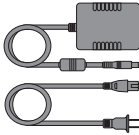

External power supply



Product registration and software authorization card



PreSonus Health Safety and Compliance Guide

Power User Tip: All companion software and drivers for your PreSonus Quantum-series interface are available for download from your My PreSonus user account. Simply visit <http://my.presonus.com> and register your Quantum-series interface to receive downloads and licenses.

1.3 What's in your My PreSonus Account

Once you register your ATOM, you will be able to download the following:



Studio One Professional recording software and content



Universal Control (necessary for firmware updates)

1.4 Companion PreSonus Products

Thanks for choosing PreSonus! As a solutions company, we believe the best way to take care of our customers (that's you) is to ensure that you have the best possible experience from the beginning of your signal chain to the end. To achieve this goal, we've prioritized seamless integration throughout every design phase of these products from day one. The result is systems that communicate with each other as intended—straight out of the box—without excessive configuration hassles.

We're here for you. Find out more at www.presonus.com.

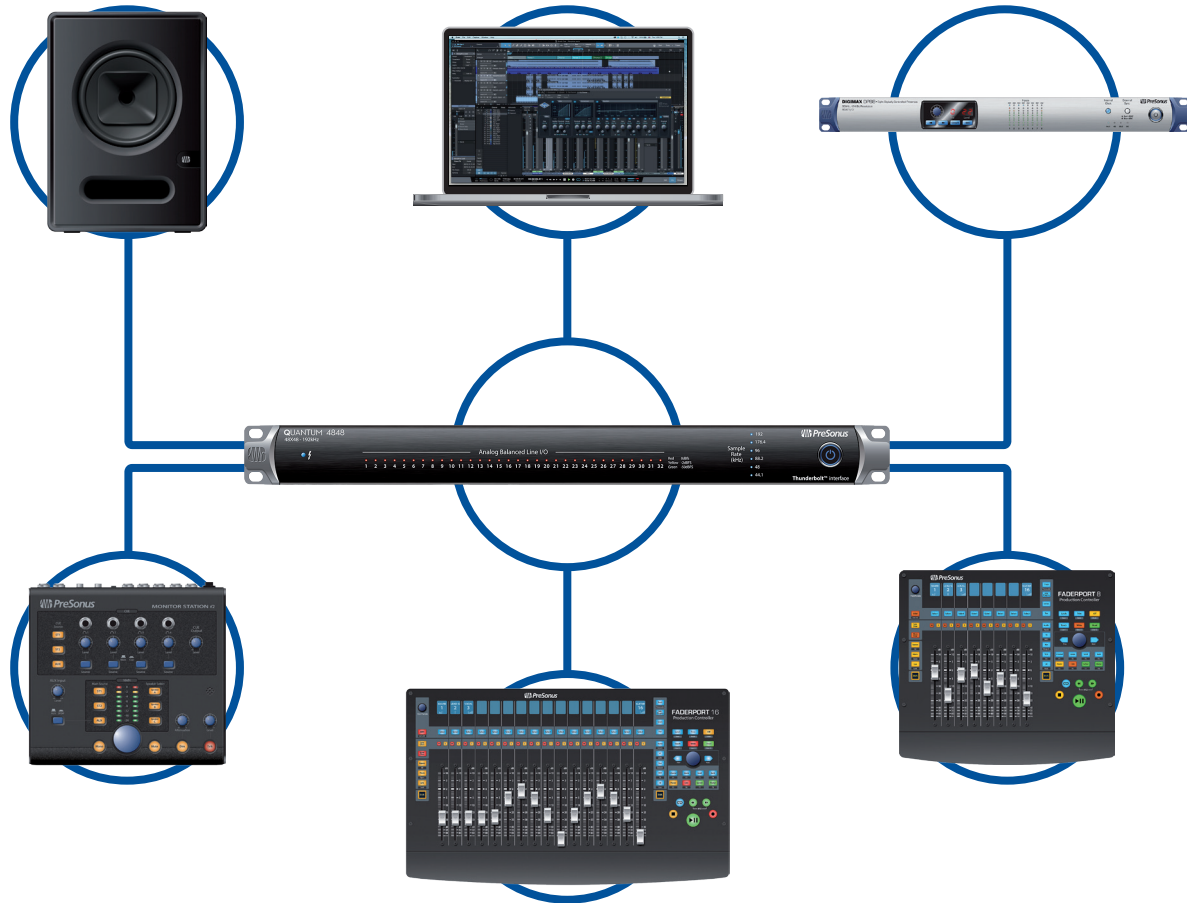

2 Hookup

2.1 Front Panel Indicators



Thunderbolt Sync. This indicator will illuminate blue when your Quantum 4848 is properly synced to your computer over Thunderbolt.

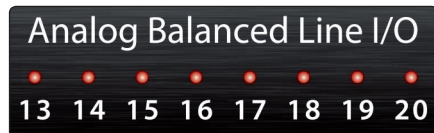

Signal Indicators. These 32 indicators can be set to monitor either the analog input or analog output signal from UC Surface. *See Section 4.2.*

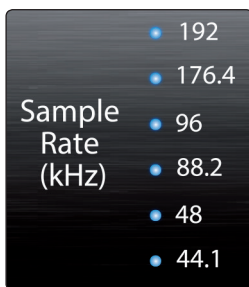

Sample Rate Indicators. These LEDs display the currently set Sample Rate for your Quantum 4848.



Power button and Sync light. The lighted ring around the power button of your Quantum 4848 is a clock source / sync indicator. It lets you know if your unit is receiving word clock correctly.

- **Blue.** When this light is blue, your Quantum 4848 is correctly synced via Thunderbolt, word clock, or ADAT.
- **Flashing red and blue.** Quantum 4848 is in the process of trying to sync to a received clock signal.
- **Red.** Quantum 4848 is either not synced to your computer or its external clock source is not present.
- **Flashing purple.** The identify button is active in UC Surface.

***Power User Tip:** Word clock is the timing signal with which digital devices sync frame rates. Proper word clock sync prevents digital devices from having pops, clicks, and distortion in the audio signal due to mismatched digital audio transmission. In general, you will use your Quantum 4848 interface as the master clock in your studio; it provides high-quality word clock for this purpose. However, if you would like to use another device as the master clock, you can set the input source for clocking in UC Surface. *See Section 4.1 for details.**

2.2 Back Panel Connections



Line Inputs. The lower row of DB25 connections are for use with line-level devices. These inputs are scaled to accept line-level signals up to +18 dBu.



Line Outputs. The upper row of DB25 connections provide 32 balanced line outputs to route to external devices, such as headphone amps, signal processors, and patchbays. Each output has an independent playback stream.

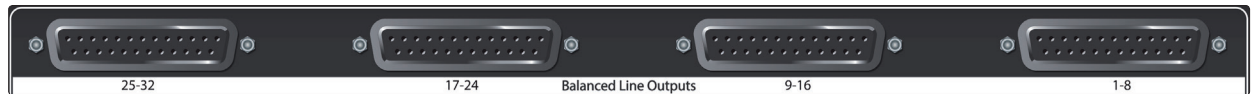

A Quick Note About DB25

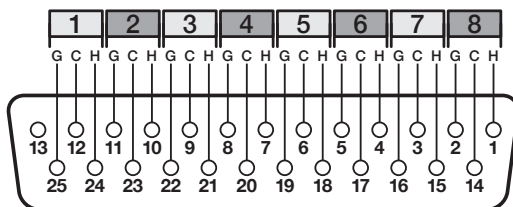

The Tascam format DB25 connectors provide eight balanced channels on a single analog connector. Balanced DB25 fan-out snakes can be obtained in various configurations at most recording and live-sound retailers. Common configurations are DB25 to (8) XLRM, DB25 to (8) XLRF, and DB25 to (8) TRS.

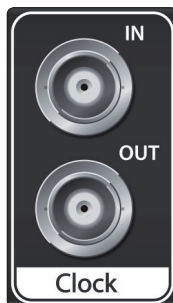

Clock In and Out. These BNC connections allow Quantum-series interfaces to receive and transmit word clock to and from other digital audio devices.

Power User Tip: When using the BNC Clock input for external clock, you will need to set "Wordclock" as the Clock Source in Universal Control as well as to set the sample rate to be the same as the external clocksource device. See Section 4.1 for details. A 75Ω BNC word clock cable is required to achieve proper sync.

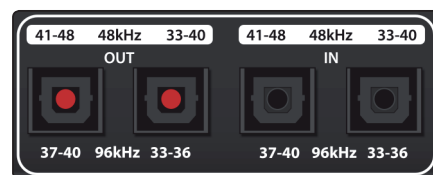

ADAT – S/MUX In and Out. These are the ADAT – Dual S/MUX connections for your external digital devices. When recording or playing back at 44.1 or 48 kHz, each ADAT I/O will provide 8 of the 16 available channels consecutively, from left to right. When recording or playing back at 88.2 or 96 kHz, each connection will provide four of the available eight channels.

These inputs and outputs do not function at 176.4 or 192 kHz:

	ADAT 1 Input	ADAT 2 Input	ADAT 1 Output	ADAT 2 Output
44.1 / 48 kHz	Channels 33-40	Channels 41-48	Channels 33-40	Channels 41-48
88.2 / 96 kHz	Channels 33-36	Channels 37-40	Channels 33-36	Channels 37-40

When connecting a PreSonus DigiMax DP88 to your Quantum 4848, the ADAT connections will also send and receive preamp control information for the DigiMax DP88, so that it can be controlled directly from UC Surface or Studio One.

Power User Tip: You will need to set "ADAT 1" as the Clock Source in Universal Control as well as to set the sample rate to be the same as the external clocksource device when clocking external via ADAT. See Section 4.1 for details. The ADAT 2 input cannot be used to receive word clock.

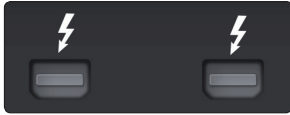

Thunderbolt ports. Use these ports to connect your Quantum 4848 to your computer. The second Thunderbolt port can be used to connect other Thunderbolt devices to your computer.

Power User Tip: Quantum interfaces support clustering over Thunderbolt. In addition to allowing you to use your Quantum-series interface as a Thunderbolt hub, this allows you to chain up to four Quantum interfaces, aggregated over Thunderbolt, for higher I/O counts. See Section 5 for more information.

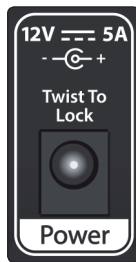

Power Connection. This is where you connect the external power supply for your Quantum 4848. Your Quantum interface is equipped with a twist-lock power connection, keep this in mind when connecting disconnecting it from your interface.

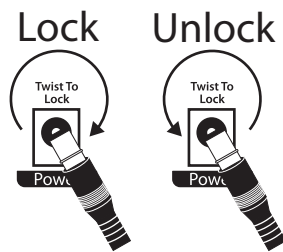

2.3 Quantum 4848 Hookup Diagram

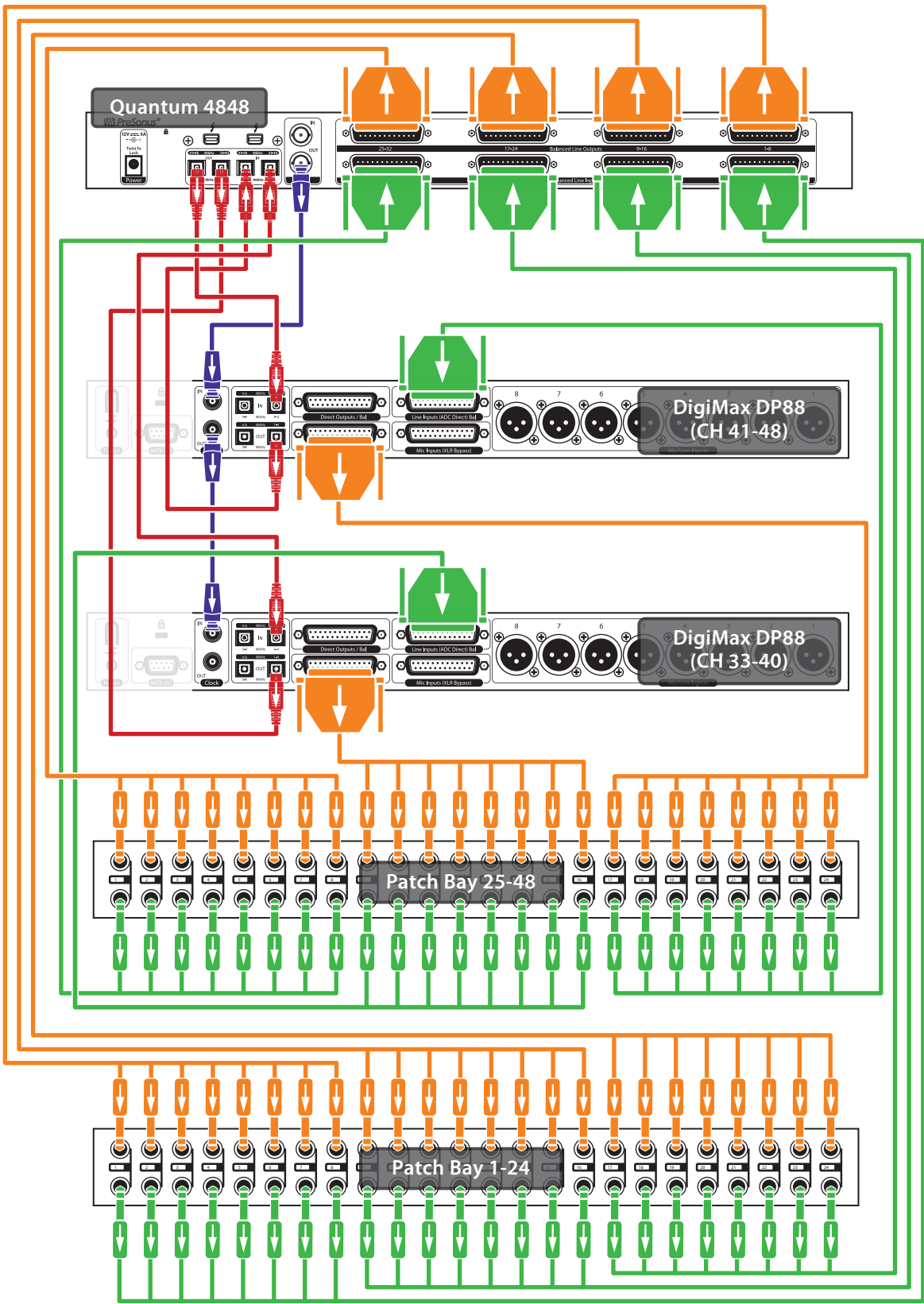

3 Connecting to a Computer

Before connecting your Quantum 4848 to a computer, please visit www.presonus.com/products/Quantum-4848/techspecs to verify the latest system requirements.

Note: *The speed of your processor, amount of RAM, and capacity, size, and speed of your hard drives will greatly affect the overall performance of your recording system. A faster processor and more RAM can reduce signal latency (delay) and improve overall performance.*

The Universal Control installer for macOS and Windows is available for download from your My PreSonus user account. This bundled installer includes Universal Control, UC Surface, and the audio driver for Quantum-series interfaces. To begin, you must create or log into your My PreSonus user account, and register your Quantum interface, either by downloading the My PreSonus app for your iOS or Android device or by visiting <http://my.presonus.com>. Once registered, all software downloads will be available from within your My PreSonus user account.

3.1 Installation for Windows and macOS

Connect your Quantum 4848 to an available Thunderbolt port and launch the Universal Control installer. The installer will take you through each step of the installation process. This application will install the macOS or Windows drivers as well as UC Surface. Please read each message carefully.

It is recommended that you quit all applications before you start the installation.

The Universal Control installer will take you through each step of the installation process.

3.2 Using a Quantum Interface with Popular Audio Applications

Complete setup instructions for Studio One Professional and a brief tutorial on its features can be found in **Section 6** of this manual. However, you can use your Quantum 4848 with any audio-recording application that supports Core Audio or ASIO. Please consult the documentation that came with your audio application for specific instructions on how to select the Quantum-series interface driver as the audio-device driver for your software.

Below are basic driver-setup instructions for a few popular audio applications.

Ableton Live

1. Launch Ableton Live.
2. Go to Options | Preferences | Audio.
3. Choose Driver Type: ASIO | Audio Device: ASIO PreSonus Quantum 4848.
4. Go to Input Config: Enable and select the desired Input channels.
5. Go to Output Config: Enable and select the desired Output channels.

Avid Pro Tools 10+

1. Launch Pro Tools.
2. Go to Setup | Hardware and select Quantum 4848 from the Peripherals list. Click OK.
3. Go to Setup | Playback Engine and select Quantum 4848 from the menu at the top of the window. Click OK.

Apple Logic

1. Launch Logic.
2. Go to Logic | Preferences | Audio.
3. Click on the Devices Tab.
4. On the Core Audio tab, check Enabled.
5. Select PreSonus Quantum 4848 from the device menu.
6. You will be asked if you'd like to relaunch Logic. Click try (re)launch.
7. Your Quantum 4848 features custom I/O labels for faster workflow. To enable these labels for use in Logic, go to Options | Audio | I/O Labels.
8. The second column in the pop-up window will be named Provided by Driver. Activate each of these labels for your Quantum 4848.

Cakewalk Sonar

1. Launch Sonar.
2. Go to Options | Audio... and click on the Advanced tab.
3. Change the Driver Mode to "ASIO." (Note: Using WDM, rather than ASIO, for pro audio applications is not recommended.)
4. Click the "OK" button.
5. Restart Sonar.
6. Go to Options | Audio... and click on the Drivers tab.
7. Highlight all input and output drivers beginning with "PreSonus Quantum 4848"
8. Go to Options | Audio... and click on the General tab.
9. Set the Playback Timing Master to "PreSonus Quantum 4848... DAW Out 1."
10. Set the Recording Timing Master to "PreSonus Quantum 4848... Line 1."

Steinberg Cubase

1. Launch Cubase.
2. Go to Devices | Device Setup.
3. Select "VST Audio System" from the Devices column in the Device Setup.
4. Select PreSonus Quantum 4848 from the ASIO Driver dropdown list.
5. Click "Switch" to begin using the Quantum driver.
6. Once you have successfully changed the driver, go to Devices | VST Connections to enable your input and output buses.

4 Universal Control and UC Surface

Included in Universal Control is UC Surface, a powerful control software for your Quantum 4848 that provides extensive metering as well as configuration options for Quantum 4848 users.

4.1 Firmware Updates

UC Surface is designed to verify that your Quantum 4848 has the correct firmware version installed. You will be prompted if your Quantum 4848 interface needs its firmware updated. Click on the Update Firmware button to begin the update.

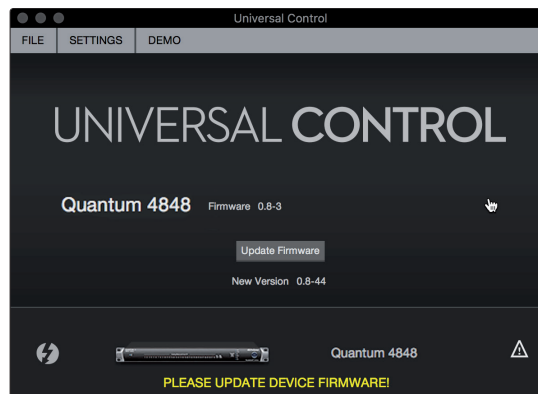

Warning: Do not power off or disconnect your Quantum 4848 during the firmware update. Once the firmware update is successfully completed, you will be alerted and instructed to disconnect your power supply and Thunderbolt cable and reconnect it before rebooting your device. *It is not sufficient to simply power down your unit, you must disconnect the power source in addition to the Thunderbolt cable.*

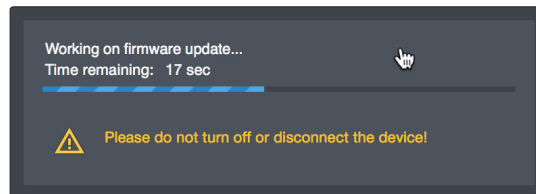

When the firmware update is complete, you must disconnect the physical power source from your Quantum 4848 and reconnect it. Powering it off it will not complete the update process.

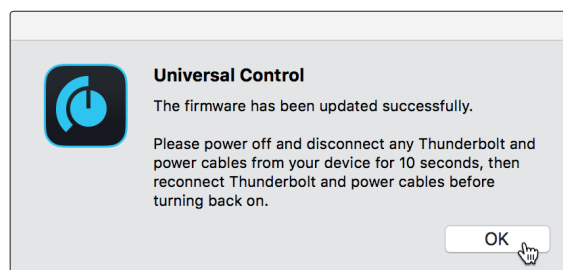

4.2 Universal Control Launch Window



Universal Control is a powerful hardware-management application for all PreSonus interface products. It allows you to view any PreSonus interface product connected to your computer or your computer's network.

When Universal Control is launched, you will see the Launch window. From this window, you can manage all the driver settings.

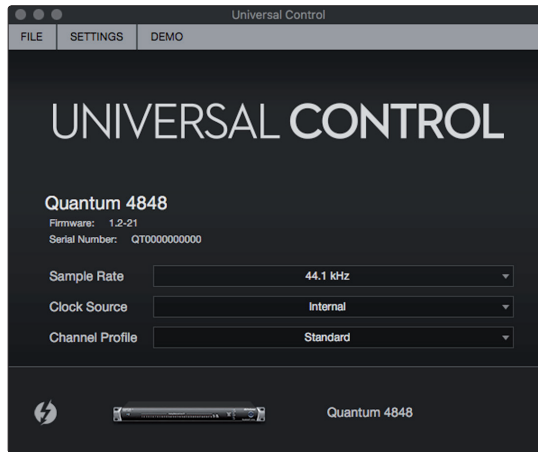

Sample Rate. Changes the sample rate.

You can set the sample rate to 44.1, 48, 88.2, 96, 176.4, or 192 kHz. A higher sample rate will increase the fidelity of the recording but will increase the file size and the amount of system resources necessary to process the audio.

Clock Source. Sets the digital clock source.

From this menu, you can set the clock source for your Quantum interface: Internal, External S/PDIF, or External ADAT. **Please note:** Only ADAT 1 can be used as a clock source input for your Quantum.

Channel Profile. Some third-party DAW applications, like ProTools Native, limit simultaneous I/O to 32 ins and outs. Channel Profile modes are provided so that you can customize your 48-channel I/O configuration for 32-channel application as follows:

	Standard	16 Line + 16 ADAT	24 Line + 8 ADAT
Input Streams			
Recording Streams 1-8	Analog 1-8	Analog 1-8	Analog 1-8
Recording Streams 9-16	Analog 9-16	Analog 9-16	Analog 9-16
Recording Streams 17-24	Analog 17-24	ADAT 1 1-8	Analog 17-24
Recording Streams 25-32	Analog 25-32	ADAT 2 1-8	ADAT 1 1-8
Recording Streams 33-42	ADAT 1 1-8	Disabled	Disabled
Recording Streams 43-48	ADAT 2 1-8	Disabled	Disabled
Output Streams			
Playback Streams 1-8	Analog 1-8	Analog 1-8	Analog 1-8
Playback Streams 9-16	Analog 9-16	Analog 9-16	Analog 9-16
Playback Streams 17-24	Analog 17-24	ADAT 1 1-8	Analog 17-24
Playback Streams 25-32	Analog 25-32	ADAT 2 1-8	ADAT 1 1-8
Playback Streams 33-42	ADAT 1 1-8	Disabled	Disabled
Playback Streams 43-48	ADAT 2 1-8	Disabled	Disabled

4.3 Metering

When you first launch UC Surface, you will be able to view the input metering for all 32 analog inputs and outputs:

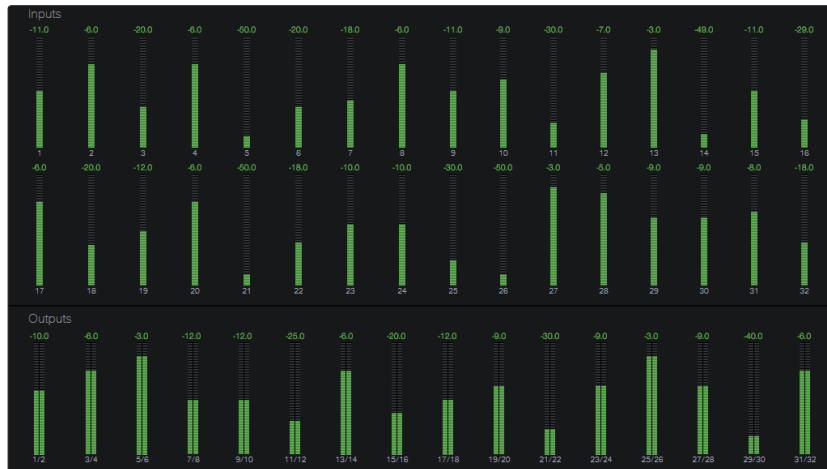

Front Panel Metering Toggle

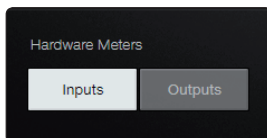

By default, the 32 LEDs on the front panel of your Quantum 4848 display the signal level for your 32 analog inputs. From UC Surface, you can toggle them to display the signal from the 32 analog outputs instead.

ADAT Inputs

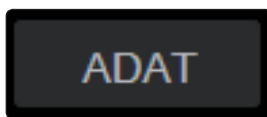

When a DigiMax DP88 is connected to the ADAT Input and Output on your Quantum 4848, you will be presented with ADAT controls, allowing you to remote control your DigiMax DP88's preamps, direct line input, and phantom power. To view these controls, click on the ADAT button in the upper right corner of the UC Surface window.

4.4 RTA

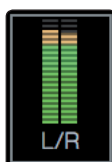

UC Surface provides a real-time analyzer (RTA) in which $x = \text{frequency}$ and $y = \text{amplitude}$ for every input and output. An RTA provides a close visual representation of what you are hearing. It provides a view of the long-term spectrum of the signal, such as the one third-octave spectrum long-term average of a musical performance. To enable the RTA for any input or output, select its meter from the top of the screen.

The Quantum RTA provides several customization features that allow you to view the RTA in the way that is most useful for your application.



Height. This provides a more or less granular display for the RTA.

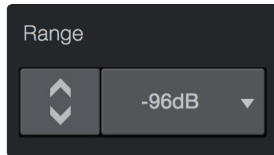

Range. Use the Range controls to set the upper and lower decibel limits that the RTA will display.

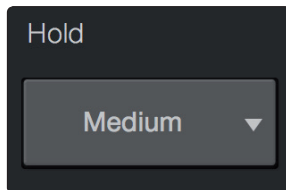

Hold. Use this control to set the peak hold time for each band of the RTA.

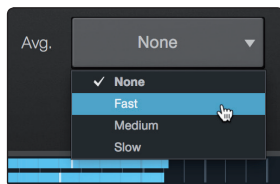

Average. Averaging is a mathematical process that takes multiple data samples and performs division to acquire a statistically more accurate calculation of the response. That's a technical way of saying that it slows down the "real-time" of a real-time analyzer.

At the bottom of the screen, you will find the signal meter. This meter can be customized for your application.

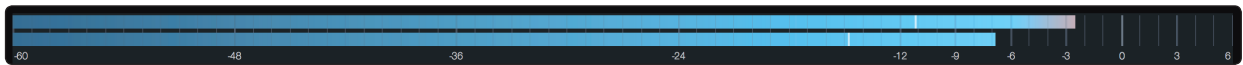

Meter Style. This menu allows you to change the type of output metering displayed at the bottom of the screen.

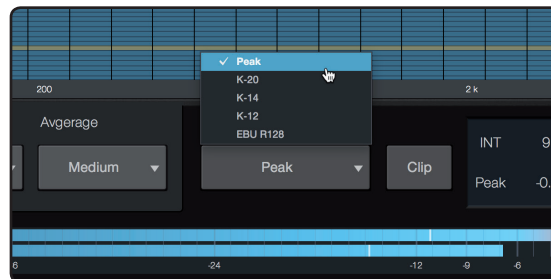

- **Peak.** This type of metering displays the instantaneous level of the audio signal.
- **K-20, K-14, and K-12.** K-System metering displays loudness metering and dynamic range. Select the scale based on the genre or media format. K-20 is used for film, classical music, and high-fidelity recordings. It provides the most dynamic range visualization. K-14 is used for mainstream pop, rock, and country. K-12 is used for broadcast and radio and provides the least dynamic range visualization.
- **EBU R128.** Displays the perceived loudness of the signal based on the EBU R128 standard.

5 Aggregating Devices

Up to four Quantum 4848 interfaces can be aggregated together for combined 192 inputs and 192 outputs at 44.1 and 48 kHz. Quantum-series interfaces are fully compatible with one another and PreSonus supports the aggregation of any four Quantum-series interfaces together.



From UC Surface, you can easily locate every Quantum interface connected to your computer by pressing the Identify button in the Device Tab. This will flash the power button purple.

5.1 macOS

1. Connect the Quantum-series interface you'd like to use as the master clock to your computer first.
2. Launch Audio MIDI Setup.

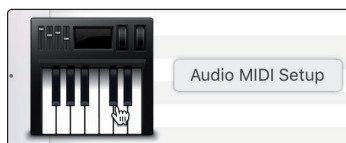

3. Select the Quantum model, and click on the plus sign in the lower left hand corner. Select "Create Aggregate Device."

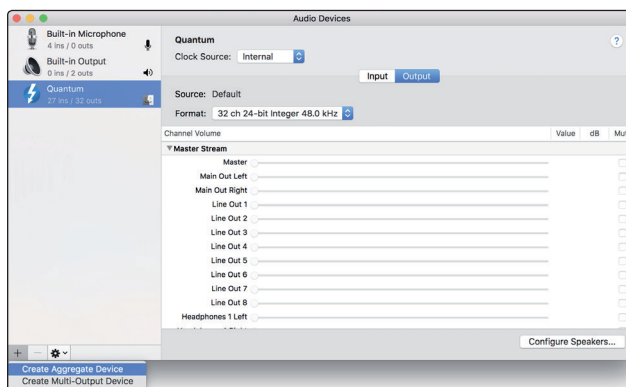

4. Check the Use box to the left of the master Quantum-series interface.

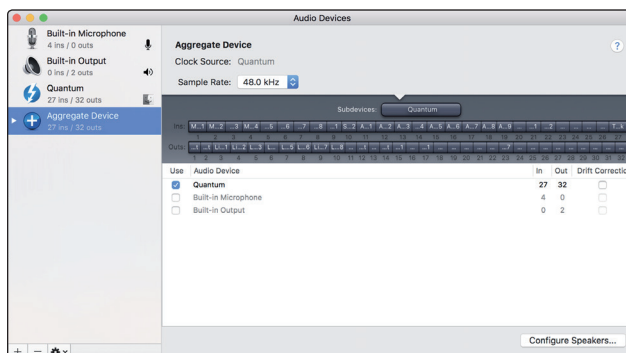

- Connect your other Quantum interfaces.

Power User Tip: For tighter clocking, PreSonus recommends designating one Quantum interface as the master and using BNC wordclock to sync additional units.

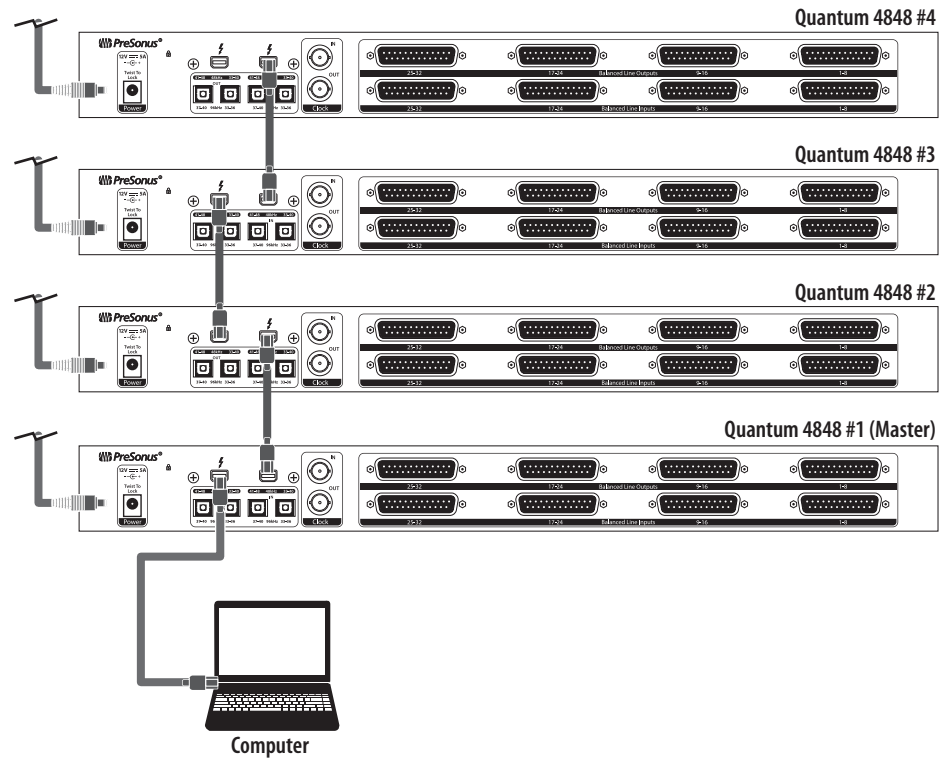

- Check the Drift Correction box beside each slaved Quantum-series interface.

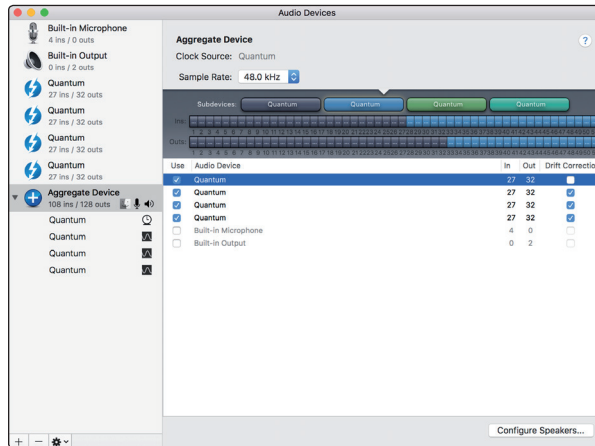

Your Quantum system is now ready to use.

5.2 Windows

1. Connect your Quantum interfaces to your computer and launch Universal Control.

Please Note: Your Quantum interfaces must be clocked to each other via BNC and one unit must be designated as the master.

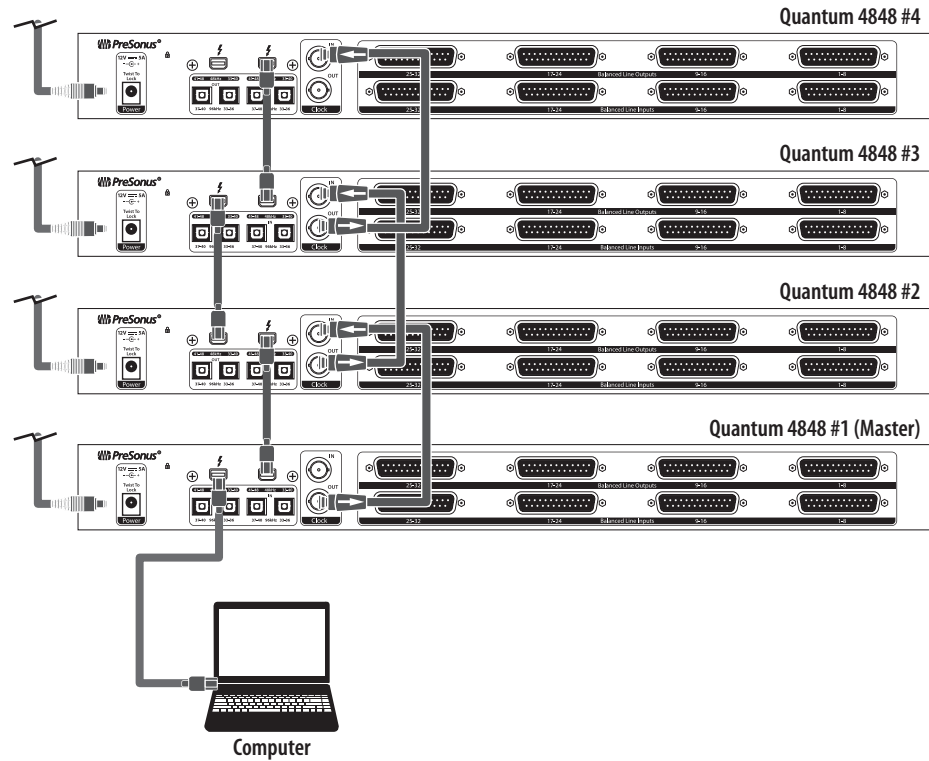

2. Select the Quantum interface you would like to use as the first bank of channels and set the priority to "1."

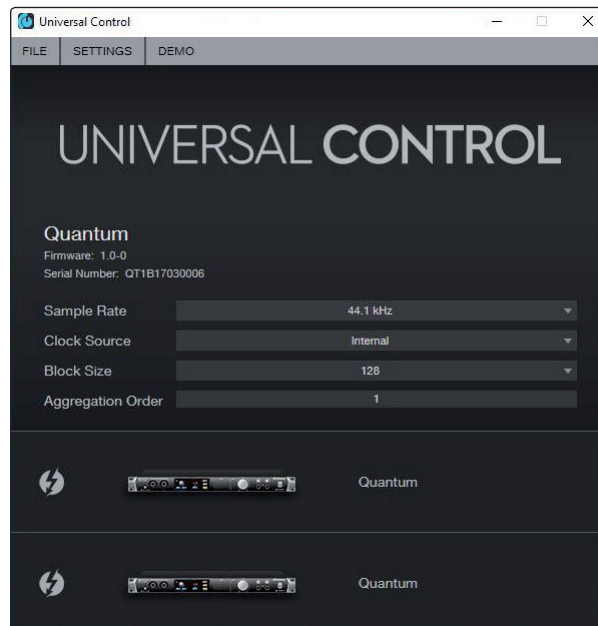

3. Select the Quantum interface you would like to use for the next bank of channels. Set the priority to "2" and the Clock Source to Wordclock.

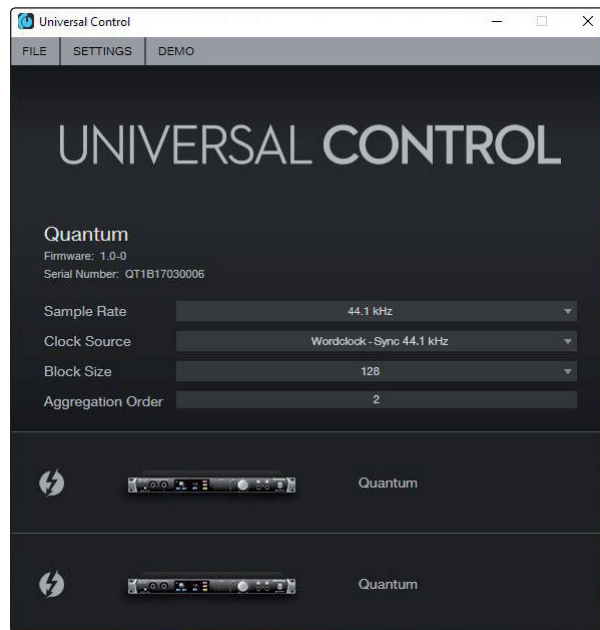

4. If you are connected three or four Quantum interfaces, you will repeat step 3 and set the priority to 3 and 4 respectively.
Your Quantum system is now ready to use.

6 Studio One Professional Quick Start

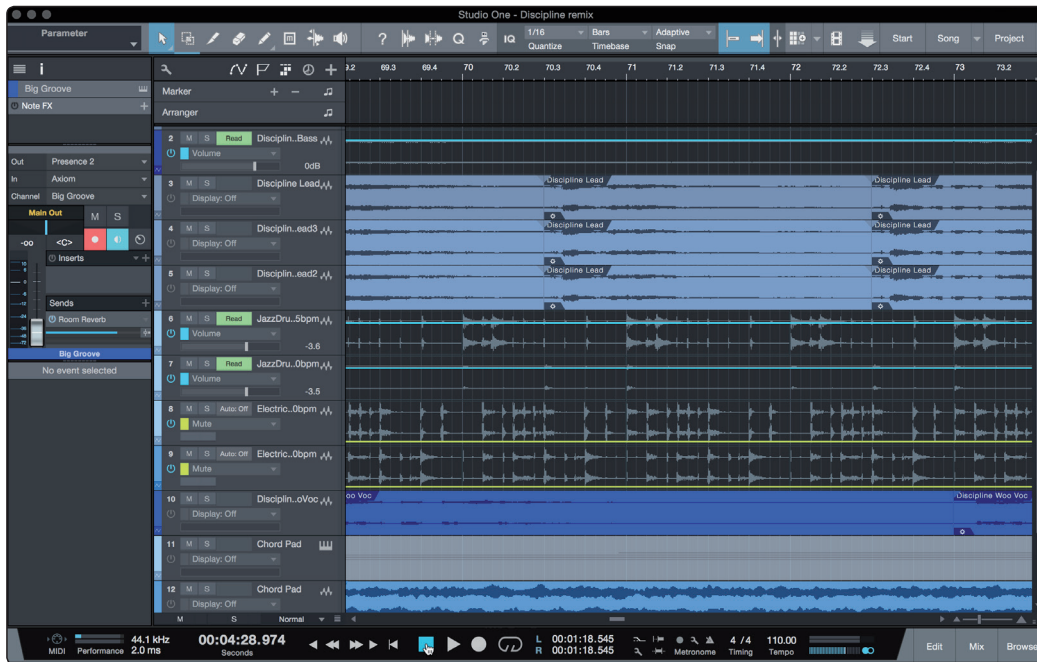

Quantum 4848 users will find a license for Studio One Professional in their My PreSonus user account. As an integrated system, Studio One Professional allows you to unleash the full potential of their Quantum 4848.

A complete user reference manual is installed with Studio One Professional. This Quick Start will guide you through set-up and configuration as well as some specialized functions for Quantum 4848. For all other functions, please consult the Studio One Reference Manual.

6.1 Installation and Authorization

Once you have installed the drivers for your audio interface and connected it to your computer, you can use the included PreSonus Studio One music-production software to begin recording, mixing, producing, and mastering your music.

To install Studio One, log into your My PreSonus account and register your interface. Your product key for Studio One will automatically be registered to your My PreSonus account with your hardware registration.

Downloading and running the Studio One installer.

To install Studio One, download the Studio One installer from your My PreSonus account to the computer on which you will use it.

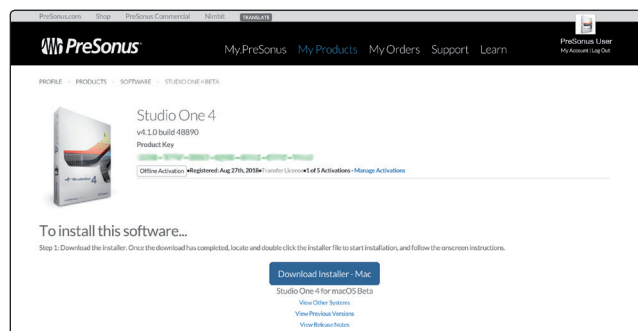

- **Windows users:** Launch the Studio One installer and follow the onscreen instructions.
- **Mac users:** Drag the Studio One application into the Applications folder on your Mac hard drive.

Authorizing Studio One

When Studio One is launched for the first time on your computer, it will communicate with your My PreSonus account and verify your registration. To ensure a seamless authorization process, make sure to download your installer to the computer on which you will be using it and be sure that your computer is connected to the Internet when you launch the application for the first time.

Installing bundled content for Studio One

Studio One comes bundled with an array of demo and tutorial materials, instruments, loops, and samples. The Studio One bundle includes all that you need to begin producing music.

The first time you launch Studio One, you will be prompted to install its companion content. Select the content you wish to add and click "Install." The content will automatically begin to download and install from your My PreSonus user account.

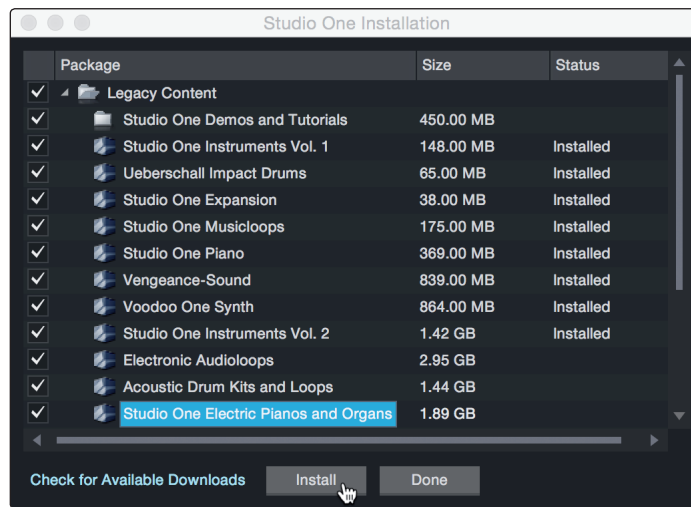

Power User Tip: You may be prompted to enter your My PreSonus user account information. Clicking "Remember Credentials" will allow you to have immediate access to any content you purchase from the PreSonus Marketplace.

6.2 Setting Up Studio One

Studio One was designed to work with PreSonus interfaces and provides unique interoperability and simplified setup. When Studio One is launched, by default you will be taken to the Start page. On this page, you will find document-management and device-configuration controls, as well as a customizable artist profile, a news feed, and links to demos and tutorials from PreSonus. If you have an Internet connection on your computer, these links will be updated as new tutorials become available on the PreSonus Web site.

As mentioned previously, complete information on all aspects of Studio One is available in the Reference Manual PDF located within Studio One. The information in this tutorial covers only the basic aspects of Studio One and is intended to get you set up and recording as quickly as possible.

6.2.1 Configuring Audio Devices

1. In the middle of the Start page, you will see the Setup area. Studio One automatically scans your system for all available drivers and selects a driver. By default, it will choose a PreSonus driver if one is available.

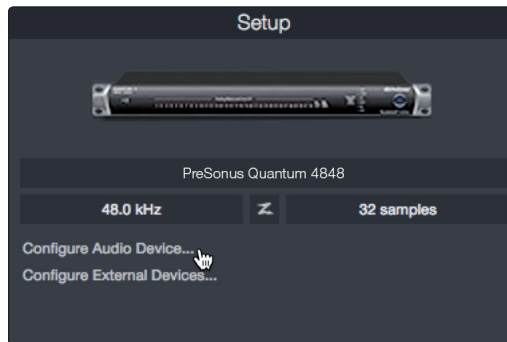

2. If you do not see your device listed on the Start page when you launch Studio One, click on the Configure Audio Devices link in the Setup area to open the Options window.

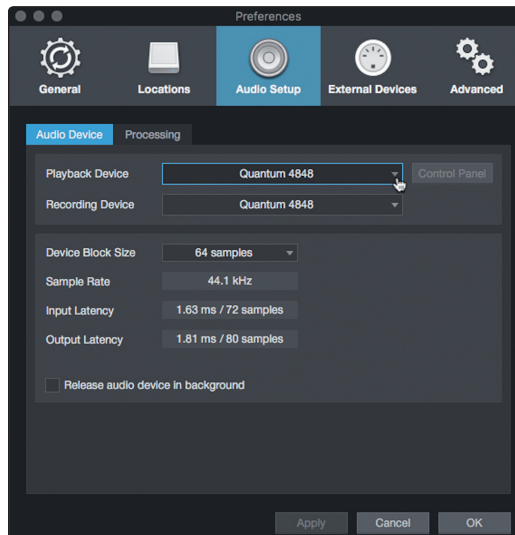

In the Options window, click on the Audio Setup tab and select your device driver from the pull-down.

6.2.2 Configuring MIDI Devices

From the External Devices window in Studio One, you can configure your MIDI keyboard controller, sound modules, and control surfaces. This section will guide you through setting up your MIDI keyboard controller and sound modules. Please consult the Reference Manual located within Studio One for complete setup instructions for other MIDI devices.

If you are using a third-party MIDI interface or USB MIDI-controller keyboard, you must install any required drivers for these devices before beginning this section. Please consult the documentation that came with your MIDI hardware for complete installation instructions.

If you do not have any MIDI devices, please skip to Section 6.3.

Setting up an external MIDI keyboard controller from the Start page.

A MIDI keyboard controller is a hardware device that is generally used for playing and controlling other MIDI devices, virtual instruments, and software parameters. In Studio One, these devices are referred to as Keyboards, and they must be configured before they are available for use. In some cases, your MIDI keyboard controller is also used as a tone generator. Studio One views the controller and

tone-generation functions as two different devices; a MIDI keyboard controller and a sound module. The MIDI controls (keyboard, knobs, faders, etc.) will be set up as a Keyboard. The sound modules will be set up as an Instrument.

You can set up your external MIDI devices from the Setup area in the Start page. Before setting up a new Song for recording, take a moment to configure external devices.

Make sure you have connected the MIDI Out of your external MIDI controller to a MIDI In on your MIDI interface. If you are using a USB MIDI controller, connect it to your computer and power it on.

1. Click on the Configure External Devices link in the Setup area on the Start page to launch the External Devices window.



2. Click the Add button. This will launch the Add Device window.

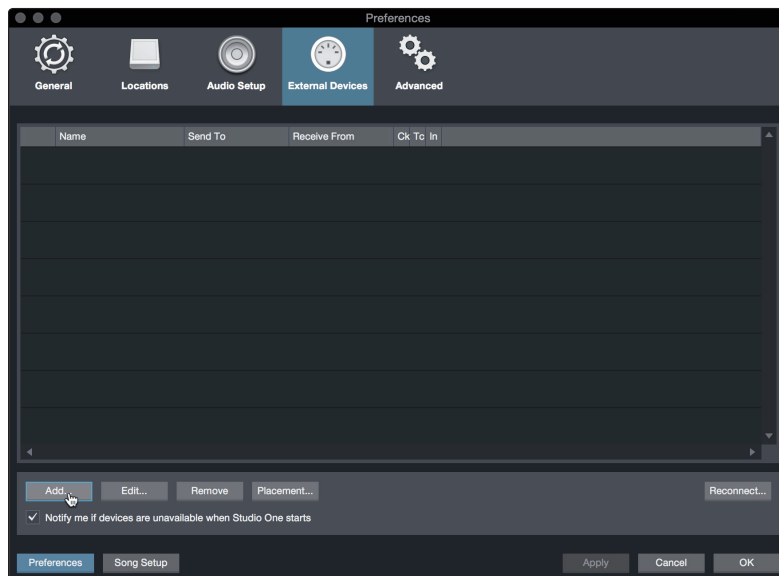

3. From the menu on the left, select your MIDI controller from the list of manufacturers and models. If you do not see your MIDI controller listed, select New Keyboard. At this point, you can customize the name of your keyboard by entering the manufacturer and device names.



4. You must specify which MIDI channels will be used to communicate with this keyboard. For most purposes, you should select all MIDI channels. If you are unsure of which MIDI channels to choose, select all 16.
5. Studio One allows you to filter out specific control functions. If you would like Studio One to ignore Aftertouch, Pitch Bend, Program Change, or All CC messages, enable filtering for any or all of these messages.
6. In the Receive From drop-down menu, select the MIDI interface input from which Studio One will receive MIDI data (that is, the MIDI port to which your keyboard is connected).

Power User Tip: In the Send To drop-down menu, select the MIDI interface output from which your Studio One will send MIDI data to your keyboard. If your keyboard controller doesn't need to receive MIDI data from Studio One, you can leave this unselected.

7. If this is the only keyboard that you will use to control your external synthesizers and virtual instruments, you should check the box next to Default Instrument Input. This will automatically assign your keyboard to control all MIDI devices in Studio One.
8. Click OK.

If you have a sound module that you'd like to connect, leave the External Devices window open and proceed to the next part of this section. If not, you can close the window and **skip to Section 6.3**.

Setting up an external MIDI sound module from the Start page.

MIDI instrument controllers (keyboards, MIDI guitars, etc.) send musical information in the form of MIDI data to tone modules and virtual instruments, which respond by generating sound, as instructed. Tone modules can be standalone sound devices or can be integrated into a MIDI instrument, such as a keyboard synthesizer. Studio One refers to all tone generators as Instruments. Once you have set up your MIDI keyboard controller, take a moment to configure your sound module.

Make sure you have connected the MIDI In of your external sound module to the MIDI Out of your MIDI interface.

9. In the External Devices window, click the Add button.

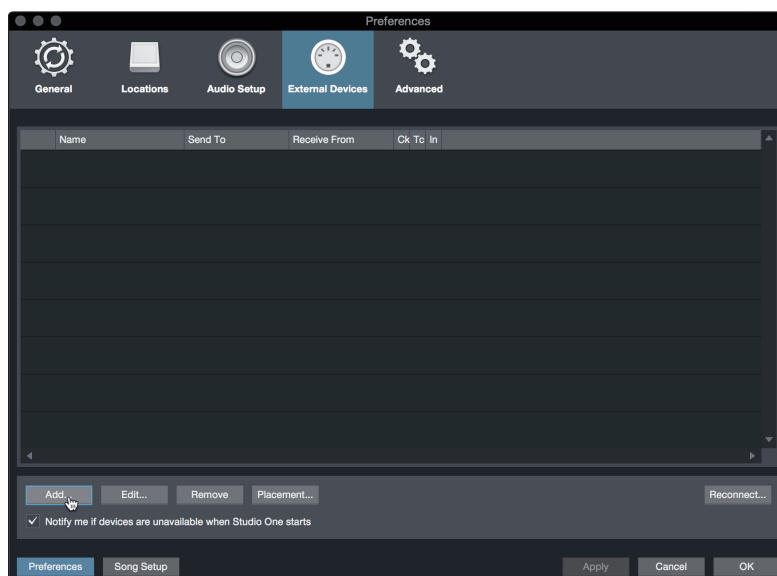

10. Select your device in the menu on the left. If your device is not listed, select New Instrument. At this point you can customize the name of your keyboard by entering the manufacturer and device names.

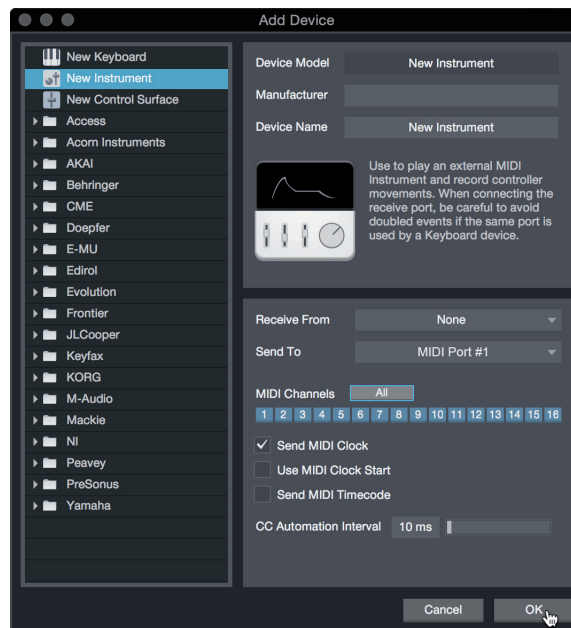

11. Specify which MIDI channels will be used to communicate with this sound module. For most purposes, you should select all MIDI channels. If you are unsure of which MIDI channels to select, we suggest you select all 16.
12. In the Send To menu, select the MIDI interface output from which Studio One will send MIDI data to your sound module. Click OK and close the External Devices window. You are now ready to start recording in Studio One.

The rest of this Quick Start Guide will go over how to set up a Song and will discuss some general workflow tips for navigating through the Studio One environment.

6.3 Creating a New Song

Now that you've configured your audio and MIDI devices, let's create a new Song. We'll start by setting up your default audio I/O.

1. From the Start page, select Create a New Song.

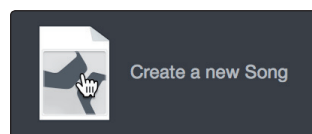

Power User Tip: Studio One Professional is an integrated recording and mastering solution. To create a new environment to record, create a New Song. To create a mastering project, create a New Project. Complete information on using the Project Page to master Studio One sessions and audio files can be found in the Studio One Reference Manual.

- In the New Song window, name your Song and choose the directory in which you'd like it saved. You'll notice a list of templates on the left. These templates provide quick setups for a variety of devices and recording situations. The section will describe creating a Song from an empty session.



- Select Empty Song from the Templates list. At this point, you should give your Song a name and select your preferred sample rate and bit depth for recording and playback. You can also set the length of your Song and the type of time format you would like the timeline to follow (notation bars, seconds, samples, or frames). Click the OK button when you are finished.

Power User Tip: If you plan to import loops into your Song, make sure that the *Stretch Audio Files to Song Tempo* option is selected. This will automatically import loops at the correct BPM.

6.3.1 Configuring Your I/O

- Click on Song | Song Setup to set your sample rate and resolution and configure your audio I/O.

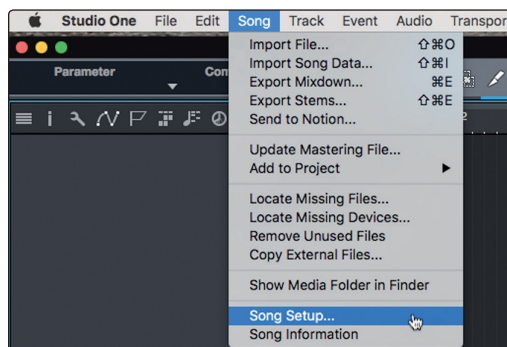

- Click on the Audio I/O Setup tab.

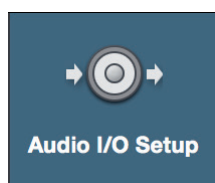

- From the Inputs tab, you can enable any or all of the inputs on your PreSonus Quantum audio interface that you'd like to have available. We recommend that you create a mono input for each of the inputs on your interface. If you plan on recording in stereo, you should also create a few stereo inputs.

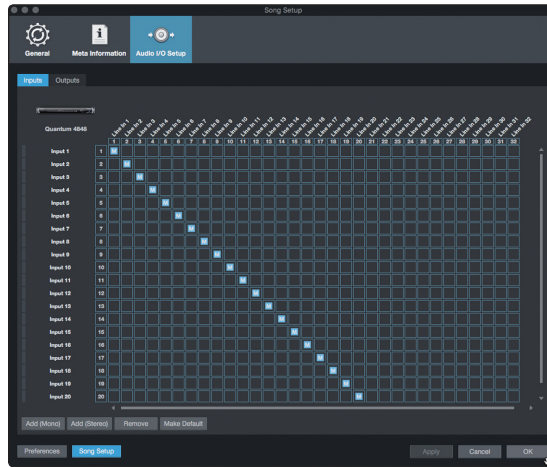

- Click on the Outputs tabs to enable any or all of the outputs on your Quantum audio interface. In the lower right corner, you will see the Audition select menu. This allows you to choose the output from which you will audition audio files prior to importing them into Studio One. In general, you will want this to be the main output bus.

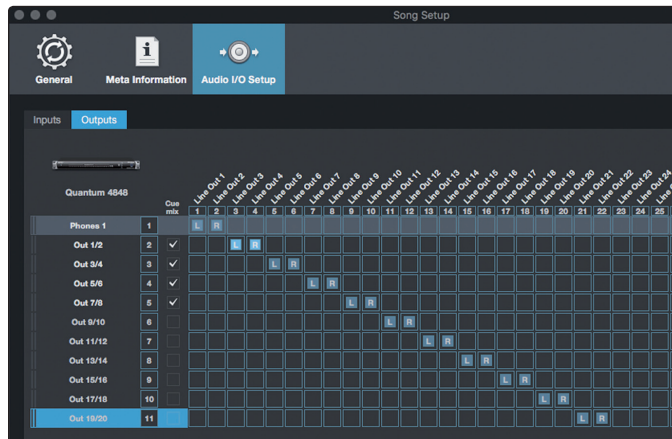

Power User Tip: If you would like this I/O configuration to be the same every time you open Studio One, click the Make Default button.

Studio One allows you to create monitor mixes right from the console. To enable this function, you must designate at least one output pair to be a Cue Mix output. Click on the Cue Mix box next to any output pair you'd like to use as a monitor mix output to enable this feature.

For more information, *see Section 6.4.*

6.3.2 Creating Audio and MIDI Tracks

- In the upper left corner of the Arrange window, you will notice several buttons. The button furthest to the right is the Add Tracks button. Click on this button to open the Add Tracks window.

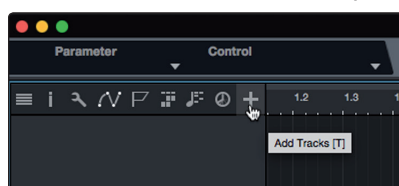

- In the Add Tracks window, you can customize the track name and color, add a preset rack of effects, and set the physical source for the input and output of your audio tracks. Most important, you can select the number and type of tracks you'd like to create.

Power User Tip: If you'd like the Talkback mic available for your session, create a track with the Talkback input (Input 27) set as the source. This will allow you to route it to your Cue Mix outputs. See Section 6.5.

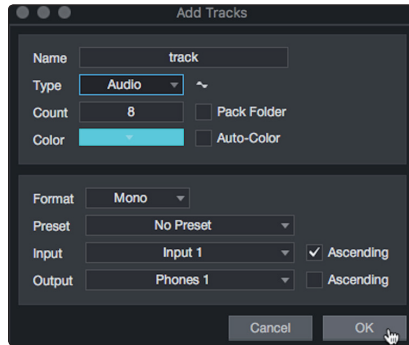

- Audio.** Use this track type to record and playback audio files.
- Instrument.** Use this track to record and playback MIDI data to control external MIDI devices or Virtual Instrument plug-ins.
- Automation.** This track type lets you create automated parameter controls for your session.
- Folder.** This track helps you to manage your session as well as to quickly edit multiple tracks at once.

Power User Tip: If you would like to add an audio track for each of the available inputs, simply go to Track | Add Tracks for All Inputs.

Track anatomy:

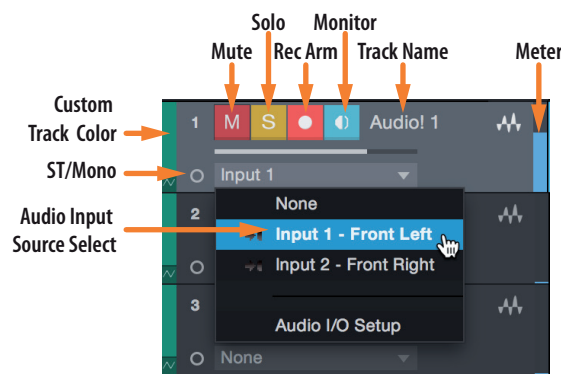

Note: MIDI tracks are nearly identical to Audio tracks. The Input Source list for MIDI tracks lists available external MIDI devices as well as any virtual instruments that have been added to the Song.

6.3.3 Recording an Audio Track

1. To begin recording, create an audio track from the Add Tracks window, set its input to Input 1 on your Quantum 4848 interface, and connect a source to the same input.

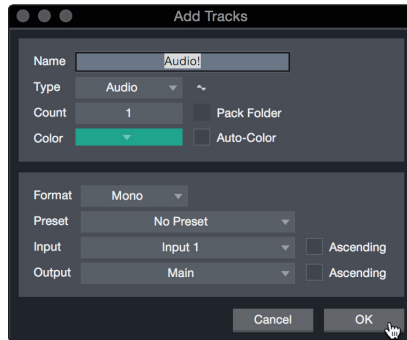

2. Select Record Enable on the track. Turn up the Input 1 level on your audio interface while speaking/singing into the microphone. You should see the input meter in Studio One react to the input. Adjust the gain so the input level is near its maximum without clipping (distorting).

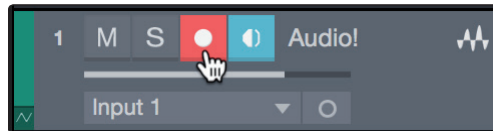

You are now ready to start recording. For complete instructions, *please consult the Studio One Reference manual located in Help | Studio One Reference Manual.*

6.3.4 Adding Virtual Instruments and Effects

You can add plug-ins and instruments to your Song by dragging-and-dropping them from the browser. You can also drag an effect or group of effects from one channel to another, drag in customized effects chains, and instantly load your favorite virtual-instrument preset without ever scrolling through a menu.

Opening the browser.

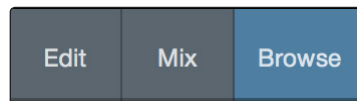

In the lower right corner of the Arrange window are three buttons:

- The **Edit** button opens and closes the audio and MIDI editors.
- The **Mix** button opens and closes the Mixer window.
- The **Browse** button opens the browser, which displays all of the available virtual instruments, plug-in effects, audio files, and MIDI files, as well as the pool of audio files loaded into the current session.

Drag-and-drop virtual instruments.

To add a virtual instrument to your session, open the browser and click on the Instrument button. Select the instrument or one of its patches from the instrument browser and drag it into the Arrange view. Studio One will automatically create a new track and load the instrument as the input.

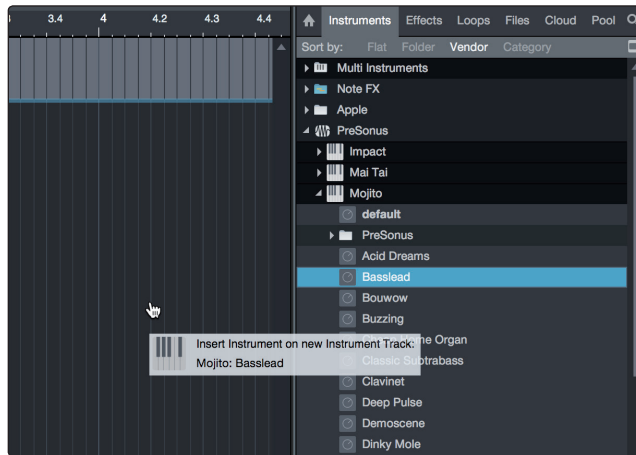

Drag-and-drop effects.

To add a plug-in effect to a track, click the Effects button in the browser and select the plug-in or one of its presets in the effects browser. Drag-and-drop the selection over the track to which you would like to add the effect.

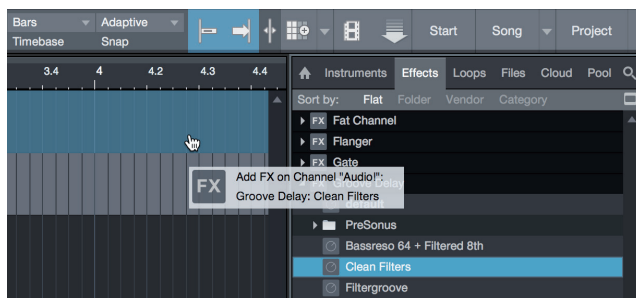

Drag-and-drop audio and MIDI files.

Audio and MIDI files can be quickly located, auditioned, and imported into your Song by dragging them from the file browser into the Arrange view. If you drag the file to an empty space, a new track will be created with that file placed at the position to which you dragged it. If you drag the file to an existing track, the file will be placed as a new part of the track.

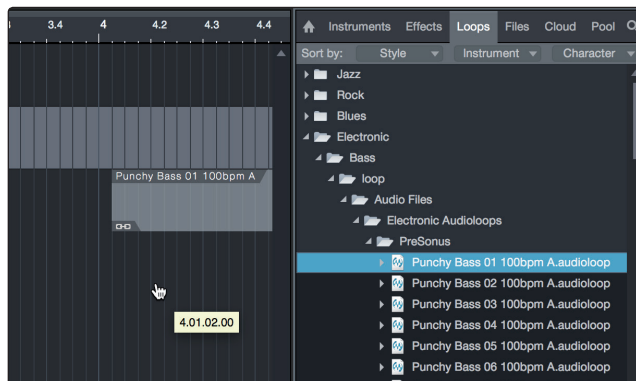

6.4 Optimizing Latency and Performance

When you are working with a large amount of audio tracks and virtual instruments, computer performance can limit your capabilities. Increasing the buffer size will free up computer resources, but this comes at the cost of greater latency (or delay) when monitoring audio inputs or playing virtual instruments. Setting the buffer too low can cause audio dropouts and glitches.

To solve this paradox, Studio One lets you set two processing buffers: one for playback and effects processing separately and another for audio input and virtual instrument monitoring.

6.4.1 Device Block Size



From the Audio Setup Preferences menu we used to select the audio driver in [Section 6.2.1](#), you can also set the Device Block Size. This determines the amount latency that you hear when monitoring audio inputs or playing virtual instruments. For the lowest latency, Device Block Size should be set to the lowest setting that provides the performance you need.

6.4.2 Audio Dropout Protection

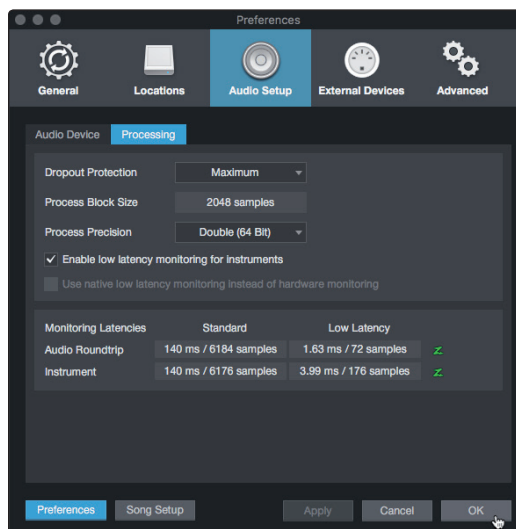

Clicking on the Processing tab in the Audio Setup Preferences window, will allow you to set the amount of Audio Dropout Protection you would like to employ. This will automatically set a buffer size for playback and processing of audio tracks, distinct from the Device Block Size setting.

If you use Native or Hardware Low-Latency Monitoring, the Dropout Protection level has no effect on audible latency, though higher levels can affect the responsiveness of onscreen meters and displays.

Setting the process Block Size to an amount greater than the Device Block Size will automatically let you have the option to use Native Low-Latency Monitoring.

The Monitoring Latencies display shows you the latency values for audio inputs (round-trip, from input to output) and virtual instruments, based on the current Device Block Size and Dropout Protection settings. The "Standard" column shows the latency for the current settings if you choose not to use Low-Latency Monitoring, while the "Low Latency" column shows values for the Native Low-Latency Monitoring system.

Monitoring Latencies	Standard	Low Latency	
Audio Roundtrip	140 ms / 6184 samples	1.63 ms / 72 samples	z
Instrument	140 ms / 6176 samples	3.99 ms / 176 samples	z

6.4.3 Plug-in Use with Native Low-Latency Monitoring

When monitoring an audio input or virtual instrument through the Native Low-Latency Monitoring system, any inserted FX on the corresponding Channel continue to function and can be heard in real time, provided that they add 3 ms or less of latency. Plug-ins that meet this latency requirement show a green power button in the Console (rather than blue or gray).

Any inserted plug-ins that introduce more than 3 ms of latency are not audible in the monitoring path while a Channel is armed for monitoring or recording under Native Low-Latency Monitoring. They begin functioning again when recording/monitoring mode is disengaged.

6.5 Monitor Mixing in Studio One

You can set up monitor mixes with your Quantum interface using Studio One's unique Cue Mix feature. This feature provides monitor mix control for your Quantum 4848 with independent level and pan control for each channel in each mix. Simply designate a pair or pairs of outputs as a cue mix, and you'll find the Cue Mix controls in your Studio One mixer.

You can create a cue mix and send it to any output pair on your Quantum 4848. You simply need to create a stereo output bus and enable Cue Mix.

Power User Tip: It is possible to designate the main output as a cue mix. This is helpful if you often record yourself and require quick access to monitoring for live inputs. When the main output is designated as a Cue Mix, a button will appear on any audio channel, with an assigned audio input in the Console, below the Mute, Solo, Record, and Monitor buttons.

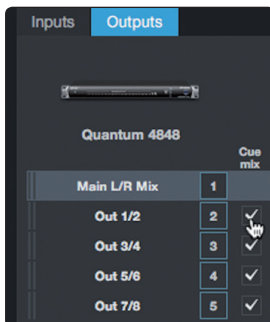

6.5.1 Cue Mix Functions

Once you have created a cue mix output, you will notice a special Send object in the channels of the Console. This Send object is called a Cue Mix object.

In the Small Console view, Cue Mix objects appear in the far left column of the extended channel.

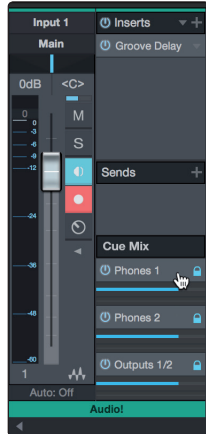

In the Large Console view, Cue Mix objects appear below the Send device rack on each channel.

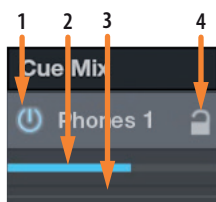

1. **Activate Button.** To completely remove any channel from a Cue Mix, simply deactivate the Cue Mix object for that channel. In most instances, you will leave this enabled.
2. **Horizontal Level Fader.** This is the channel's Cue Mix volume control. By default this level will be identical to the level set on the channel's fader. Once you move the Cue Mix level fader, the volume of that channel in the Cue Mix will be independent of the main mix or any other cue mix in the session.
3. **Pan Control.** This sets the pan position for the channel in the Cue Mix outputs. Like volume, panning is identical to the main mix by default.
4. **Lock to Channel button.** By default, the Lock to Channel button is enabled, and level and pan values are locked to the Channel level and pan controls for the Main mix. This means that each Cue Mix will be identical to the Main mix in the Console. Changing the level or panning in the Main mix will change the level or panning in the Cue Mix. However, changing the level or panning in the Cue Mix object will unlock both settings, allowing independent control of level and panning for each channel in each Cue Mix. Thus, the level and panning for channels in a Cue Mix can be completely different from the related level and pan in the Main mix. At any time, you can lock the Cue Mix level and pan back to the channel settings by clicking on the Lock to Channel button.

6.5.2 Punching In

The Quantum 4848's unique integration with Studio One and ultra-low latency performance make punching in easier than ever. This section will guide you through setting up a punch in so that there is no change sonically between audio you're playing back and the audio you're recording.

1. Before you begin, go to Studio One>Preferences and click on the Advanced tab.

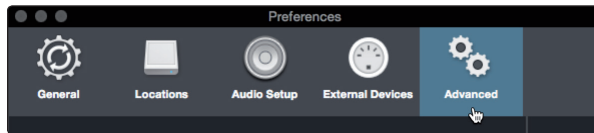

2. On the Console preference tab, check the box next to "Audio track monitoring mutes playback (Tape Style)". This will allow you use Cue Mix to monitor during a punch in. Click Apply and then OK.

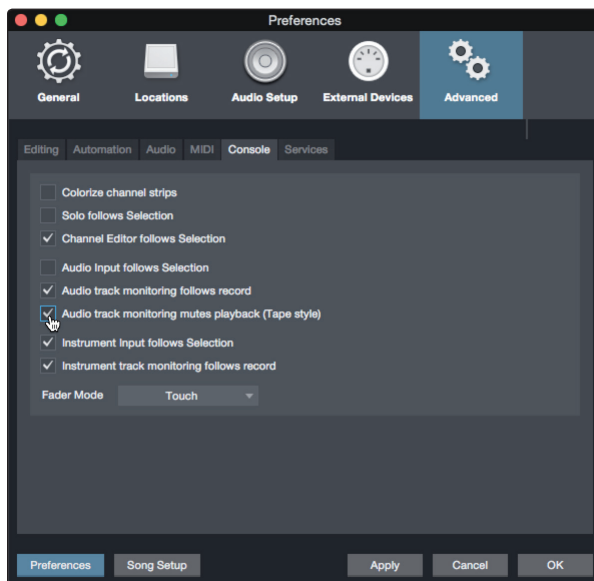

3. After you have recorded your audio, set the punch in and out points in the timeline.

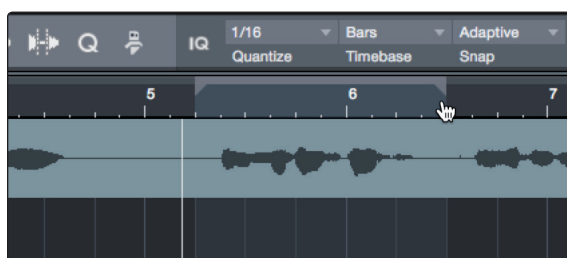

4. Enable the Autopunch button the left of the Metronome settings in the transport.

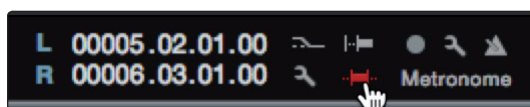



- Record Arm your track, making sure to disable input monitoring.

You're now ready to punch in. Simply rewind to the point in the song at which you'd like to start and click record.

6.6 Pipeline XT

Pipeline XT is a unique plug-in that allows you to insert external hardware into your session and treat it just like a plug-in. Once inserted, Pipeline XT can be dragged and dropped in the insert path to change order with other plug-ins, presets can be stored, and more. With automatic latency compensation and the Quantum 4848's low-latency Thunderbolt drivers, Pipeline XT is the perfect tool to integrate your hardware rack into your Studio One session.

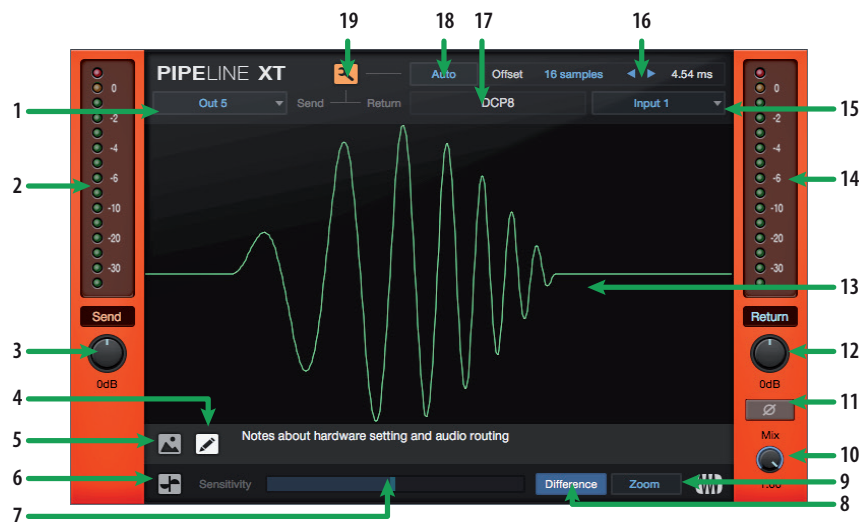

- Send Output.** This dropdown menu allows you to select the physical Quantum 4848 output you would like to use to connect to your external hardware unit. *Note: Mono instances of Pipeline XT require a mono output bus. Stereo instances of Pipeline XT can use mono or stereo output buses.*
- Send Meter.** Monitors the output level from Studio One to your external hardware unit.
- Send Level.** Adjusts the send level from Studio One to your external hardware unit.
- Text Edit.** Click to add notes about your Pipeline setup. Notes will appear in the field to the right.

5. **Show Picture.** Pipeline XT supports adding a picture of your hardware unit. This can be especially useful to store setting to recall later. When viewing the image, clicking on the “...” in the upper right corner will allow you to add a new image. Image size is limited to 1200x1200 pixels.
6. **Scope Mode.** Provides a visualization of the live input and output signals. While in this mode, you'll be able to hear both the input and the output signals simultaneously. This will allow you to check for phasing issues and adjust the offset if necessary. Scope Mode is mutually exclusive with Setup Mode (#19).
7. **Sensitivity Control.** Use this control to adjust how the scope reacts to transients. As you move the slider to the right, the sensitivity is lowered.
8. **Difference.** Displays the difference between the send and return signals. If the latency is compensated correctly and both signals are gain staged the same, the curves will be aligned and the difference signal will be zero.
9. **Zoom.** Click to Zoom in on the Scope measurement.
10. **Mix.** Pipeline lets you blend the preprocessed signal with the processed signal. Use the Mix control to set the blend.
11. **Phase Invert.** Flips the polarity of the return signal.
12. **Return Level.** Sets the level of the return signal to Studio One.
13. **Scope / Image display.** This field will display the scope result or a custom image depending on the mode.
14. **Return Meter.** Displays the return level from your external hardware unit to Studio One.
15. **Return Input.** This dropdown menu allows you to select the physical input on your Quantum 4848 to which the return signal from your external hardware is connected. *Note: Mono instances of Pipeline XT require a mono input. Stereo instances of Pipeline XT require a stereo input.*
16. **Manual Offset.** Use these controls to manually adjust the offset to compensate for latency.
17. **Name.** Click to add the name of the hardware to which Pipeline XT is connected.
18. **Auto.** Click the Auto button after wiring and configuring your input and output connections. This will measure the latency and compensate automatically. Once calculated, you can use the Manual Offset controls (#16) to make manual adjustments as needed.
19. **Setup Mode.** Setup Mode sends a test signal, or “ping” from Studio One to your external hardware. Both the ping and the returned signal will be displayed, however, you will only hear the input signal. Use this mode to set your latency compensation. Setup Mode is mutually exclusive with Scope Mode (#6).

7 Technical Information

7.1 Specifications

Line Inputs

Type	DB25 (Tascam Format), Balanced)
Maximum Input Level	+18 dBu (Balanced, min. gain)
Frequency Response	20 Hz to 20 kHz (+/- 0.15 dB, unity gain, 48 kHz) 20 Hz to 40 kHz (+/- 0.22 dB, unity gain, 96 kHz)
Dynamic Range (min. gain, A-wtd)	> 118 dB
THD+N (1 kHz, min. gain)	< 0.005%
Input Impedance	10 k Ω

Line Outputs

Type	DB25 (Tascam Format), Impedance Balanced, DC Coupled
Maximum Output Level	+18 dBu
Frequency Response	20 Hz to 20 kHz (+/- 0.15 dB, unity gain, 48 kHz) 20 Hz to 40 kHz (+/- 0.22 dB, unity gain, 96 kHz)
Dynamic Range (A-wtd)	> 118 dB
THD+N	< 0.0035% (1 kHz, +4 dBu)
Output Impedance	51 Ω

Crosstalk

Input to Input	< -110 dB
Output to Output	< -115 dB
Input to Output	< -120 dB

Signal Level LEDs

Green	-50 dBFS
Yellow	-2 dBFS
Red	-0.5 dBFS

Digital Audio

Connection Type	Thunderbolt 2
ADC Dynamic Range	120 dB (A-wtd)
DAC Dynamic Range	120 dB (A-wtd)
Bit Depth	24 bits
Internally Supported Sample Rates	44.1, 48, 88.2, 96, 176.4, 192 kHz

Clock

Jitter	<70 ps RMS (20 Hz – 20 kHz)
Jitter Attenuation	>60 dB (1 ns in => 1 ps out)

Power

External Power Supply	12 VDC, 5A
-----------------------	------------

Physical

Dimensions (H x D x W)	1.75" x 7" x 19" (45 x 178 x 483 mm)
Weight	6 lbs (2.7 kg)

8 Warranty Information

PreSonus' warranty obligations for this hardware product are limited to the terms set forth below:

8.1 How Consumer Law Relates To This Warranty

THIS WARRANTY GIVES YOU SPECIFIC LEGAL RIGHTS, AND YOU MAY HAVE OTHER RIGHTS THAT VARY FROM STATE TO STATE (OR BY COUNTRY OR PROVINCE). OTHER THAN AS PERMITTED BY LAW, PRESONUS DOES NOT EXCLUDE, LIMIT OR SUSPEND OTHER RIGHTS YOU MAY HAVE, INCLUDING THOSE THAT MAY ARISE FROM THE NONCONFORMITY OF A SALES CONTRACT. FOR A FULL UNDERSTANDING OF YOUR RIGHTS YOU SHOULD CONSULT THE LAWS OF YOUR COUNTRY PROVINCE OR STATE.

PreSonus Products And EU Statutory Warranty

When you purchase PreSonus products, European Union consumer law provides statutory warranty rights in addition to the coverage you receive from the PreSonus limited warranty. A summary of the EU Statutory Warranty and the PreSonus Limited Warranty is below:

	EU Consumer Law	PreSonus Limited Warranty
Repair or Replacement Coverage For	Defects present when customer takes delivery	Defects arising after customer takes delivery
Warranty Period	2 years (minimum) from original date of purchase (unless superseded by PreSonus)	1 year from original date of purchase (unless superseded by PreSonus)
Cost of Coverage	Provided at no additional cost	Included at no additional cost
Who to contact to make a claim	The seller	PreSonus technical support for your region

What This Warranty Covers

PreSonus Audio Electronics, Inc., ("PreSonus") warrants defects in material and workmanship in PreSonus-branded products under normal use. This Limited Warranty applies only to hardware products manufactured by or for PreSonus that can be identified by the PreSonus trademark, trade name, or logo affixed to them.

Exclusions and Limitations

This warranty does **not** cover the following:

1. Damage caused by accident, abuse, improper installation, failure to follow instructions in the applicable owner's manual or improper operation, rental, product modification, alteration, or neglect.
2. Damage from improper grounding, faulty wiring (AC and signal), faulty equipment, or connection to a voltage range outside published specifications (see applicable owner's manual).
3. Damage to drivers or diaphragm assemblies found to have burnt voice coils from over/under driving or signal surge from another device.
4. Damage occurring during shipment or improper handling.
5. Damage caused by repair or service performed by persons not authorized by PreSonus.
6. Products on which the serial number has been altered, defaced, or removed.
7. Products purchased from an unauthorized PreSonus dealer (products that have transferable warranties are excluded from this provision provided the customer and the product are registered with PreSonus).

Who This Warranty Protects

This Warranty protects only the original retail purchaser of the product (products that have transferable warranties are excluded from this provision provided the customer and the product are registered with PreSonus)

How Long This Warranty Lasts

The Warranty begins on the original date of purchase from the retail purchaser, and the duration is as follows:

1-Year Limited Warranty		
Product Category	Model	Transferable
Recording Interfaces	AudioBox-, Studio-, Studio 192-, FireStudio™-, and Quantum-series	No
Preamplifiers	ADL-series, BlueTube DP V2, DigiMax-series, RC500, Studio Channel, and TubePre V2	No
StudioLive® Mixers	AI-series, AR-series, Classic, and Series III	No
Monitoring & Controlling	Central Station Plus, Ceres-series, Eris®-series, FaderPort™-series, HP-series, Monitor Station V2, R-series, Sceptre®-series, Temblor®-series	No
Accessories	Covers, Dolly, PRM1 mic, Sub Pole, breakout cables, power supplies, M10 Kit	No
3-Years Limited Warranty		
Product Category	Model	Transferable
Live Sound	StudioLive AI 328, 312, 315, 185	Yes
6-Years Limited Warranty		
Product Category	Model	Transferable
Live Sound	AIR10, AIR12, AIR15, AIR15s, AIR18s, ULT10, ULT12, ULT15, ULT18	Yes

What PreSonus Will Do

PreSonus will repair or replace, at our sole and absolute option, products covered by this warranty at no charge for labor or materials. If the product must be shipped to PreSonus for warranty service, the customer must pay the initial shipping charges. PreSonus will pay the return shipping charges.

How to Get Warranty Service (USA)

1. You must have an active user account with PreSonus and your hardware must be on file with your account. If you do not have an account, please go to <https://my.presonus.com> and complete the registration process.
2. Contact our Technical Support Department at (225) 216-7887 or log a support ticket at: <http://support.presonus.com>. TO AVOID THE POSSIBILITY OF SENDING IN A PRODUCT THAT DOES NOT HAVE A PROBLEM, ALL SERVICE REQUESTS SHALL BE CONFIRMED BY OUR TECH SUPPORT DEPARTMENT.
3. The return authorization number, as well as shipping instructions, shall be provided after your service request is reviewed and confirmed.
4. The product should be returned for service in the original product packaging. Products may be shipped in a manufactured “flight” or “road” style cases but PreSonus will NOT cover any shipping damage to these cases. Products that are not shipped in the original product package or a manufactured case may not receive a warranty repair, at PreSonus’ sole discretion. Depending on the product model and the condition of your original packaging, your product may not be returned to you in the original packaging. The return shipping box may be a generic box that has been fitted for that model tested if the original gift box is not available.

How to Get Warranty Service (outside of USA)

1. You must have an active user account with PreSonus and your hardware must be on file with your account. If you do not have an account, please go to: <https://my.presonus.com> and complete the registration process.
2. Contact the Technical Support/Service Department for your region at www.presonus.com/buy/international_distributors and follow procedures provided by your PreSonus contact.

Limitation of Implied Warranties

ANY IMPLIED WARRANTIES, INCLUDING WARRANTIES OF MERCHANTABILITY AND FITNESS FOR A PARTICULAR PURPOSE, ARE LIMITED IN DURATION TO THE LENGTH OF THIS WARRANTY.

Some states, countries, or provinces do not allow limitations on how long an implied warranty lasts, so the above limitation may not apply to you.

Exclusion of Damages

PRESONUS'S LIABILITY FOR ANY DEFECTIVE PRODUCT IS LIMITED TO THE REPAIR OR REPLACEMENT OF THE PRODUCT, AT PRESONUS'S SOLE OPTION. IF PRESONUS ELECTS TO REPLACE THE PRODUCT, THE REPLACEMENT MAY BE A RECONDITIONED UNIT. IN NO EVENT WILL PRESONUS BE LIABLE FOR DAMAGES BASED ON INCONVENIENCE, LOSS OF USE, LOST PROFITS, LOST SAVINGS, DAMAGE TO ANY OTHER EQUIPMENT OR OTHER ITEMS AT THE SITE OF USE, AND, TO THE EXTENT PERMITTED BY LAW, DAMAGES FOR PERSONAL INJURY, OR ANY OTHER DAMAGES WHETHER INCIDENTAL, CONSEQUENTIAL OR OTHERWISE, EVEN IF PRESONUS HAS BEEN ADVISED OF THE POSSIBILITY OF SUCH DAMAGES.

Some states, countries, or provinces do not allow limitations on how long an implied warranty lasts, so the above limitation may not apply to you.

If you have any questions about this warranty or service received, please contact PreSonus (USA) at +1-225-216-7887 or contact one of our authorized international distributors at www.presonus.com/buy/international_distributors.

Product features, design, and specifications are subject to change without notice.

Added bonus: PreSonus' previously Top Secret recipe for . . .

Redfish Couvillion

Ingredients:

- ¼ C Vegetable oil
- ¼ C flour
- 1 onion diced
- 1 clove garlic minced
- 1 green pepper diced
- 3 celery stalks diced
- 1 14oz can diced tomatoes
- 1 bottle light beer
- 2 bay leaves
- 1 tsp thyme
- 2 lbs Redfish fillets

Cooking Instructions:

1. In a heavy saucepan or large skillet, heat oil on medium high and slowly add flour a tablespoon at a time to create a roux. Continue cooking the roux until it begins to brown, creating a dark blond roux.
2. Add garlic, onions, green pepper, and celery to roux.
3. Sauté vegetables for 3-5 minutes until they start to soften.
4. Add tomatoes, bay leaves, thyme, and redfish. Cook for several minutes.
5. Slowly add beer and bring to a low boil.
6. Reduce heat and simmer uncovered for 30-45 minutes until redfish and vegetables are completely cooked, stirring occasionally. Break up redfish into bite size chunks and stir in. Add pepper or hot sauce to taste. Do not cover.
7. Serve over rice

Serves 6-8

While not one of Southeast Louisiana's more famous dishes, Redfish Couvillion is a favorite way to serve our favorite Gulf fish. Also known as Reds or Red Drum, Redfish is not only fun to catch, it's also delicious!

Quantum 4848

Ultra-low latency Thunderbolt™ Audio Interface

Owner's Manual

