

StudioLive™ AR-Series

Hybrid Digital/Analog Production Mixers

Owner's Manual



Table of Contents

1 Overview — 1

- 1.1 Introduction — 1
- 1.2 About This Manual — 1
- 1.3 Summary of Features — 2
 - 1.3.1 Hardware Features — 2
- 1.4 What is in the Box — 3
- 1.5 What is in your My PreSonus Account — 3

2 Getting Started — 4

- 2.1 Level-Setting Procedure — 4

3 Hookup — 6

- 3.1 Connections and Controls — 6
 - 3.1.1 Inputs — 6
 - 3.1.2 Outputs — 7
 - 3.1.3 Rear Panel Connections — 8
- 3.2 Channel Controls — 8
 - 3.2.1 Digital Returns — 9
- 3.3 The Super Channel — 9
 - 3.3.1 Pairing a Bluetooth Device — 10
- 3.4 Monitor Buses — 10
 - 3.4.1 Monitor Bus Controls — 10
 - 3.4.2 Creating Monitor Mixes — 11
- 3.5 Internal FX Bus — 12
 - 3.5.1 Effects Presets — 12
 - 3.5.2 Internal FX Bus Return — 13
 - 3.5.3 Creating Internal Effects Mixes — 13
 - 3.5.4 Using an External Effects Processor — 14
- 3.6 Master Section Controls — 15
 - 3.6.1 Control Room Levels — 15
- 3.7 Typical Band Setup Diagram — 16
- 3.8 Typical Home Studio Setup Diagram — 17

4 SD Recording and Playback — 18

- 4.1 SD Recording — 18
- 4.2 SD Playback — 19

5 Resources — 20

- 5.1 EQ Frequency Guides — 20
- 5.2 Block Diagrams — 22
 - 5.2.1 StudioLive AR22, AR16 USB, and AR12 USB Block Diagram — 22
 - 5.2.2 StudioLive AR8 USB Block Diagram — 24
- 5.3 Recall Sheets — 26
 - 5.3.1 AR22 USB, AR16 USB and AR12 USB Recall Sheet — 26
 - 5.3.2 AR8 USB Recall Sheet — 28
- 5.4 Technical Specifications — 29

6 Troubleshooting and Warranty — 32

- 6.1 Troubleshooting — 32
- 6.2 Warranty Information — 33
 - 6.2.1 How Consumer Law Relates To This Warranty — 33

1 Overview

1.1 Introduction



Thank you for purchasing a PreSonus® StudioLive™ AR-series mixer, the world's most advanced hybrid digital/analog production mixer. PreSonus Audio Electronics has designed the StudioLive AR-series mixers utilizing high-grade components to ensure optimum performance. Loaded with high-headroom microphone preamplifiers; a built-in USB 2.0 recording and playback engine; parametric EQ on every channel; onboard Bluetooth™ playback; integrated stereo SD recording and playback; a multi-effects processor with a dedicated mix bus; monitor mixes; extensive LED metering; and more, StudioLive AR breaks new boundaries for live and studio performance and production. All you need are a few microphones and cables, speakers, and your instruments, and you are ready to mix and record in the studio or in front of a live audience!

We encourage you to contact us with questions or comments regarding this product. PreSonus Audio Electronics is committed to constant product improvement, and we value your suggestions highly. We believe the best way to achieve our goal of constant product improvement is by listening to the real experts: our valued customers. We appreciate the support you have shown us through the purchase of this product.

For technical support, *please see Section 6.1: Troubleshooting.*

1.2 About This Manual

We suggest that you use this manual to familiarize yourself with the features, applications, and connection procedures before using your StudioLive AR-series mixer. This will help you avoid problems during installation and setup. This manual covers the hardware functions and features of all three StudioLive AR-series mixers. When functional differences are called out, the AR22 USB will be mentioned first, followed by the AR16 USB, then the AR12 USB, and then the AR8 USB.

Information on using your StudioLive AR mixer as an audio interface, as well as your licenses and installers for Capture™ and Studio One® Artist, can be found in your My PreSonus user account.

Throughout this manual you will find Power User Tips. These tips provide mixing tricks, some of which are unique to the StudioLive AR mixers, as well as explanations of various audio terms. In addition, you will find an assortment of audio tutorials throughout this manual.

Thank you, once again, for buying our product. We are confident that you will enjoy your StudioLive AR mixer!

1.3 Summary of Features

1.3.1 Hardware Features

- 22/18/14/8-channel mixer with 12/8/4/2 mono, 4/4/4/2 stereo, and one super stereo channel
- 16/12/8/4 high-quality microphone preamps with global 48V
- 2 instrument inputs
- 20/16/12/6 balanced line inputs
- 4/2/2 unbalanced inserts (AR22 USB, AR16 USB and AR12 USB)
- 2 (L/R) RCA inputs
- 1/8-inch stereo input
- Highpass filter on every channel
- 3-band semi-parametric EQ
- 22/18/14/8 x 4 USB 2.0 audio interface
- Bluetooth playback
- 2x2 SD recorder
- Internal power supply
- Pan, mute, and PFL soloing on every channel
- XLR Main outputs
- Control Room outputs (stereo TRS, plus headphone)
- 2/2/2/1 Auxiliary monitor buses with TRS outputs and AFL soloing
- Dedicated effects bus with TRS output
- Onboard effects processor with 16 presets
- Stereo effects return
- Footswitch effects bypass
- 19-inch rack-mount kit (optional for AR12 USB and AR8 USB, AR22 USB is not rack mountable)
- Capture multitrack-recording application included
- Studio One Artist DAW included

1.4 What is in the Box

In addition to this manual, your StudioLive package contains the following:



- PreSonus StudioLive AR22 USB, AR16 USB, AR12 USB, or AR8 USB hybrid digital/analog performance mixer

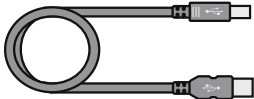

- 6-foot (1.8-meter), USB cable

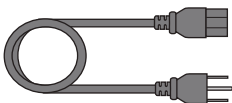

- IEC power cord

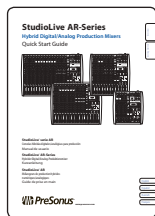

- StudioLive AR-Series Quick Start Guide

1.5 What is in your My PreSonus Account

Once you register your StudioLive AR mixer at [My.PreSonus.com](https://www.preonus.com), you will find the following software available for download in your user account:

- StudioLive AR-Series Owners Manual
- StudioLive AR-Series Software Reference Manual
- Capture multitrack-recording software
- Studio One Artist DAW software and bundled content
- ASIO drivers for Windows systems (macOS users do not require a driver)

2 Getting Started

Before you begin, here are a few general rules of thumb:

- Always turn down the Main, Control Room, and Phones level controls before making connections.
- Before plugging or unplugging a microphone while other channels are active, mute the channel to which you are connecting.
- Channel levels should be set on or near the “U” mark whenever possible. The “U” indicates unity gain, meaning the signal is neither boosted nor attenuated.
- Do not allow your inputs to clip. Watch the signal indicators and make sure the red Clip indication illuminates rarely, if ever. Clipping (overloading) the inputs can result in digital distortion, which sounds terrible.

Warning: Engaging phantom power or connecting sources without muting the channels can result in a very loud pop that can potentially damage your sound equipment. Always mute your channels before engaging Phantom power or connecting sources.

P.A. and studio equipment should be powered on in the following order:

- Sound sources (keyboards, direct boxes, microphones, etc.) connected to the StudioLive AR inputs
- StudioLive AR mixer
- Computer (if applicable)
- Power amplifiers or powered monitors

When it's time to power down, your system should be turned off in the reverse order. Now that you know what not to do, let's get some audio going!

2.1 Level-Setting Procedure

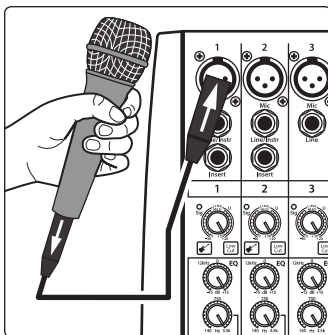

1. Grab a microphone and a mic cable and plug them into the Channel 1 mic input.

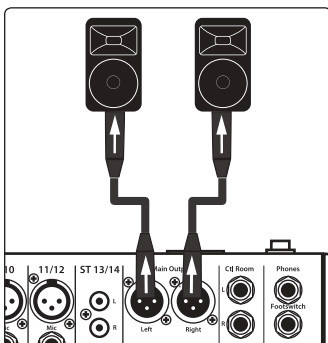

2. Connect the Main outputs of your StudioLive AR to your power amplifier or powered monitors.
3. Bring down all the level controls on your StudioLive AR to the lowest setting.
4. Make sure that the Mic/Line knob on Channel 1 is turned all the way counter-clockwise.
5. Plug your StudioLive AR-series mixer into a power outlet and turn it on.

2 Getting Started

2.1 Level-Setting Procedure

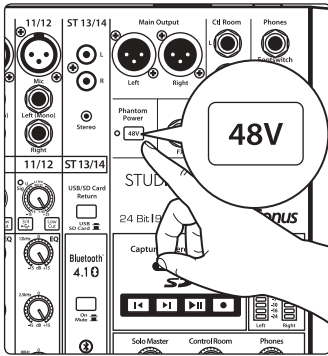

6. If your microphone requires phantom power, engage the 48V button on your StudioLive AR mixer.
7. Turn on your amplifier or powered monitors.
8. Speak or sing into your microphone at approximately the same volume you expect during the performance.

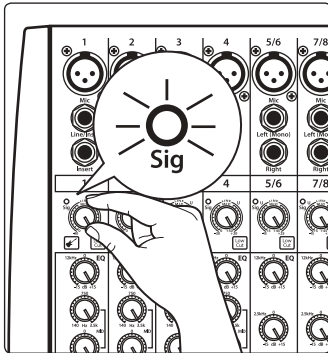

9. Turn the trim knob on Channel 1 clockwise while watching the signal indicator. Adjust the Channel 1 trim knob until the signal/clip indicator is red, then back down until it is green and just below clipping at the loudest input level.

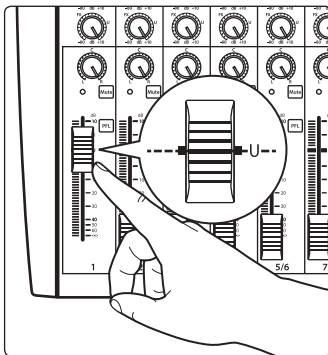

10. Raise the Channel 1 level control to unity gain (denoted with a "U").

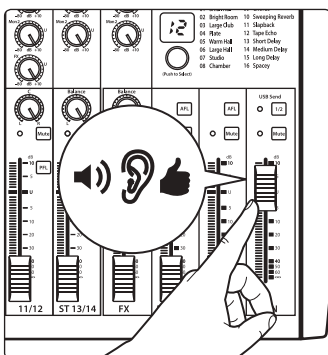

11. Bring up the Main level until you can comfortably listen to your microphone through your speakers.
12. Sculpt the sound by adding EQ to taste.

3 Hookup

3.1 Connections and Controls

3.1.1 Inputs



Microphone Inputs. Your StudioLive AR-series mixer is equipped with high-quality microphone preamplifiers for use with all types of microphones.



48-volt Phantom Power. The StudioLive AR mixers provide global 48V phantom power for all microphone inputs.

WARNING: Phantom power is required for condenser microphones but can severely damage some dynamic mics, especially ribbon mics. Therefore, unless the manufacturer of your dynamic mics clearly states that phantom power will not damage them, you should use condenser mics only, with phantom power on, or dynamic mics only, with phantom power off.

Power User Tip: Dynamic microphones and ribbon microphones are generally lower-output devices and require no external power source. The most important thing to note about ribbon microphones is that they very rarely require phantom power. In fact, unless a ribbon microphone calls specifically for phantom power, sending phantom power to it can cause severe damage. Condenser microphones are generally more sensitive than dynamic and ribbon microphones and typically require external +48V phantom power. Always review your microphone's documentation to ascertain the manufacturer's recommended operating practices.



Line-level Inputs. Each channel of your StudioLive AR-series mixer has a ¼-inch, balanced TRS connection for line-level input. Typical examples of line-level connections are synthesizer outputs, CD/DVD-player outputs, and (with exceptions) signal-processor inputs and outputs.

Note: As with any mixer, plugging in a microphone or a line-level input device, or turning phantom power on or off, will create a momentary spike in the audio output of your StudioLive AR mixer. Because of this, it is highly recommended that you mute or turn down the channel trim before changing connections or turning phantom power on or off. This simple step will add years to life of your audio equipment.



Instrument Inputs. Channels 1 and 2 are equipped with an input that can be switched between line and instrument. Use these ¼-inch connections for instruments that don't have internal preamps (guitar, bass, etc.). **See Input Source button in Section 3.2 for more information.**

Power User Tip: Active instruments have an internal preamp and a line-level output. This type of instrument should be plugged into a line input, rather than an instrument input. Plugging a line-level source into an instrument input risks damage to the input and results in a very loud and often distorted audio signal.



Insert (A22 USB, AR16 USB and AR12.USB). Channels 1-4 on the StudioLive AR22 USB are equipped with a direct-insert point. Channels 1 and 2 on the StudioLive AR16 USB and AR12 USB also have inserts. These unbalanced, ¼-inch connectors can be used to connect external processors (such as compressors, EQs, de-essers, and filters) to the channel inputs.

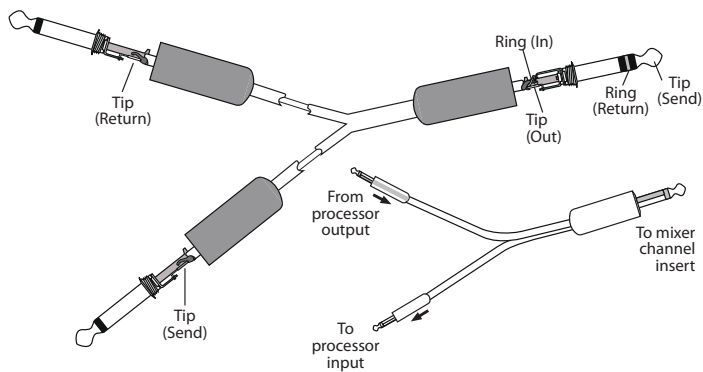

Insert-connector wiring:

Tip = send (output to inserted device)
Ring = return (input from inserted device)
Sleeve = common ground

3.1.2 Outputs

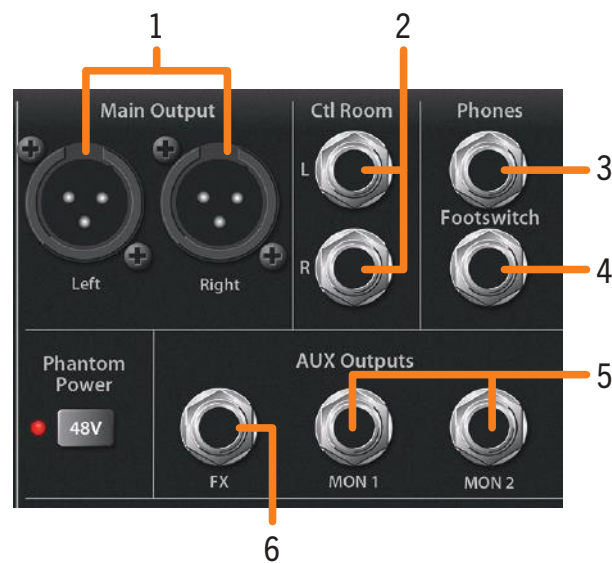

1. **Main.** The StudioLive AR-series mixers feature with XLR main outputs.
2. **Control Room.** These are the balanced control-room outputs. The Control Room knob on the top panel controls the level.
3. **Phones.** This ¼-inch TRS connection is for use with headphones. The Phones knob on the top panel controls the level.
4. **Footswitch.** This connection allows you to use an external footswitch (not included) to mute the effects return.

***Power User Tip:** Your StudioLive will follow the behavior of the type of footswitch you use. A latching footswitch allows you to mute the effects return until you engage the footswitch a second time. A momentary footswitch will allow you to mute the effects return only while the footswitch is depressed.*

5. **Monitor.** The StudioLive AR-series mixers are equipped with 2/2/2/1 monitor mix (Mon) outputs. Monitor mixes are routed to these outputs. **See Section 3.4** for more information on creating monitor mixes for monitoring.
6. **FX.** The FX send mix is routed to this output, allowing you to create an additional monitor mix. When this output is engaged, the internal effects processor is bypassed. More information about creating effects mixes and the effects processor can be found in **Section 3.5**.

3.1.3 Rear Panel Connections



USB 2.0 port. Use this port to connect your StudioLive AR-series mixer to a USB port on your computer when using the mixer as an audio interface. *See your StudioLive AR-series Software Reference Manual* for further information.

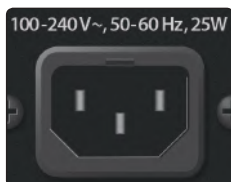

Power-input. Plug in the provided IEC power cable here.



Power switch. Push the top part of the switch (|) to turn on your StudioLive AR mixer. Push the bottom part of the switch (O) to turn it off.

3.2 Channel Controls



- Input-signal indicator.** Each channel features an LED next to the trim control that illuminates green whenever an input signal is present. The LED color will change to red if the signal (pre- or post-EQ) reaches -3 dB.
- Input Gain control.** These knobs provide 50 dB of variable gain for mono channels (0 to +50 dB mic/instrument, -20 to +30 dB line) and 40 dB of variable gain for stereo channels (+5 to +45 dB mic/instrument, -15 to +25 dB line).
- Input Source button.** Channels 1 and 2 offer an Input Source button that lets you select instrument- or line-level for the 1/4-inch inputs on these channels. Press this button to engage the instrument preamp when connecting guitars or a passive bass.
Note: Engaging the Instrument preamp will disable the microphone preamp on the XLR connection.
- Low Cut filter.** When engaged, all frequencies below 100 Hz will be attenuated (cut) at a slope of -18 dB/octave.
Power User Tip: Use the Low Cut filter to remove unwanted low-frequencies from your source signal, rather than trying to EQ them out.
- High shelving EQ Gain control.** Sets the level of the high-band center frequency (12 kHz) from -15 to +15 dB.
Power User Tip: A high shelving EQ is like a treble-control knob on a stereo. In this mode, the Center Frequency control selects the shelving frequency.
- Mid peaking EQ frequency control (AR2 USB, AR16 USB and AR12 USB).** Sets the center frequency of the Mid EQ. You can adjust the center frequency from 140 Hz to 3.5 kHz. This control is available on the Mono input channels only.
- Mid peaking EQ gain control.** Sets the level of the mid-band center frequency from -15 to +15 dB. The center frequency can be adjusted on the mono inputs of the AR16 USB and AR12 USB. All other inputs have fixed center frequency at 2.5 kHz.
- Low shelving EQ gain control.** Sets the level of the low-band center frequency (80 Hz) from -15 to +15 dB.
Power User Tip: A low shelving EQ is like a bass-control knob on a stereo. In this mode, the Center Frequency control selects the shelving frequency.

9. **Monitor sends.** These are the level controls for each channel to the corresponding monitor mix. The AR22 USB, AR16 USB and AR12 USB provide two monitor mixes, and the AR8 USB provides one monitor mix. *See Section 3.4* for more information on creating monitor mixes.
10. **FX send.** This is the level control for each channel for the effects mix. *See Section 3.5* for more information on creating effects mixes.
11. **Pan.** This sets the channels position in the Main stereo mix.
Power User Tip: Panning can be a great way to achieve better separation in your main mix. Using pan in conjunction with level will allow you to create more definition and space between each channel's signal.
12. **Mute button and indicator.** This button mutes its channel in all outputs. The LED to the left of it will illuminate red when the channel is muted.
13. **PFL (Pre-Fader Listen) button.** This button will solo its channel to the Control Room and Headphone outputs, pre-fader. When no PFL button is engaged, the Main mix is routed to these outputs.
Power User Tip: If you can't hear the main mix or a channel in your headphones, make sure that PFL is not engaged on an unused channel.
14. **Channel level.** Controls the overall level of the channel.

3.2.1 Digital Returns



The last stereo channel (19/20, 15/16, 11/12, 5/6) provides a digital playback streaming option. The Digital Return button routes playback streams 3 and 4 from your audio software to this channel. When engaged, the analog source will be bypassed; however, the signal will still be routed to the digital send so that it can be recorded or processed by a plug-in. For more information, *see your StudioLive AR-series Software Reference Manual* in your My PreSonus account.

3.3 The Super Channel



Each StudioLive AR-series mixer features a unique Super Channel that allows you to connect several analog and digital sources at once so you can get the most out of your mixer.

1. **RCA inputs.** These unbalanced inputs allow you to connect a stereo line-level device, such as a Blu-ray player or karaoke machine.
2. **1/8-inch stereo input.** This is an unbalanced, stereo, 1/8-inch connection for line-level devices such as smartphones and tablets.
3. **USB / SD Card Return.** By default, playback for the onboard SD recorder is routed to the Super Channel. Engaging this button will route USB playback streams 1-2 to the Super Channel instead. More information on using your StudioLive AR-series mixer as an audio interface can be found in the *StudioLive AR-series Software Reference Manual* in your My PreSonus user account.
4. **Bluetooth On/Off.** By default, Bluetooth playback is muted. Engaging this button will allow you to play audio through the Super Channel wirelessly.
5. **Bluetooth pairing.** Use this button to pair your Bluetooth device with your AR-series mixer. *See Section 3.3.1 for pairing instructions.*

Power User Tip: All available sources are summed into the Super Channel. Because this channel only selects line-level devices, the majority of which have onboard level controls, you can use this channel to expand the input flexibility of your StudioLive AR-series mixer.

3.3.1 Pairing a Bluetooth Device

To pair a new device to your StudioLive AR-series mixer:

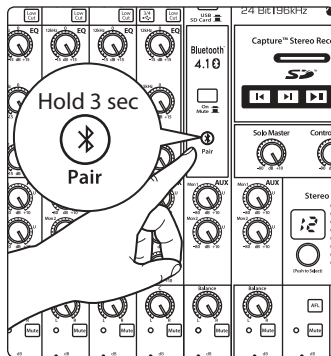

1. Press and hold the Bluetooth pairing button for three seconds.
2. The Bluetooth button will flash once every second.
3. Search for new Bluetooth devices from the device to which you'd like to pair (smartphone, tablet, etc).
4. Select "StudioLive AR22/16/12/8 USB" from the available Bluetooth devices list on the pairing device.
5. The Bluetooth button will illuminate solid when paired successfully.

Note: If previously paired, your StudioLive AR mixer will connect automatically. The Bluetooth pairing button will flash rapidly (two to three times per second) while the Bluetooth module detects connected devices and will illuminate solid when it is successfully paired.

3.4 Monitor Buses

The monitor bus provides outputs to route auxiliary mixes that are separate from the main mix. StudioLive AR-series mixers are equipped with 2/2/2/1 monitor buses, which have physical output jacks, and one internal effects bus.

Monitor buses can be used for many applications, the two most common of which are creating monitor mixes and inserting external effects processors into the mix.

3.4.1 Monitor Bus Controls



1. **AFL button.** This button will solo the aux bus to the monitor outputs after the fader.

Power User Tip: Using this control to listen in on a performer's monitor mix can be a great way to quickly dial in just the right amount of each signal and get to a great monitor mix more quickly.

2. **Mute button.** This button will mute or unmute its monitor bus. The LED to the left of it will illuminate red when the monitor output is muted.

Power User Tip: Muting a monitor mix output during performance breaks is a quick and easy way to prevent accidental signal spikes or feedback.

3. **Output level.** Adjusts the master level of the Monitor output.

3.4.2 Creating Monitor Mixes

Creating custom monitor mixes is critical. If musicians can't hear themselves or their bandmates, their performances will suffer. A monitor mix can be mono or stereo. Most often, an individual live monitor mix is mono and is sent to a floor-wedge or sidefill monitor. (The obvious exception is in-ear monitor systems.) A studio monitor mix is usually stereo because it is sent to a headphone amplifier that requires both a left- and a right-channel input. In both cases, the function of the aux bus is the same.

As an example, let's create a mono mix for Monitor Bus 1:

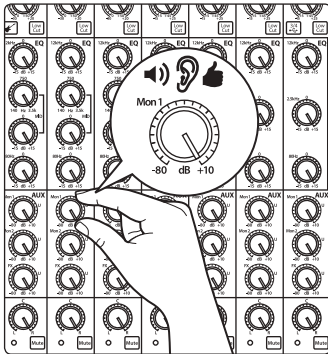

1. The Mon 1 send control for each channel sets the send level in the Mon 1 mix. Use these knobs the same way that you use the output level controls to dial in your main mix. Ask your musicians what they would like in their monitor mix and use their requests as a starting point.

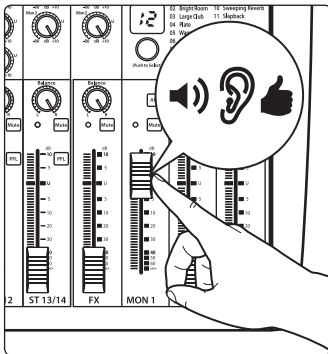

2. Use the Mon 1 Output control to adjust the overall output level.

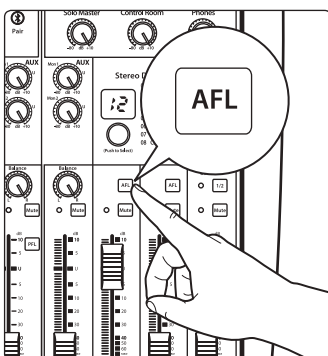

3. Press the Mon 1 AFL button to listen to the mix through the headphone or control room outputs as you make final adjustments to the mix.

3.5 Internal FX Bus

Each StudioLive AR-series mixer is equipped with an internal effects processor with 16 effects presets. This section will cover each preset, as well as how to add and use effects in your mix.

3.5.1 Effects Presets

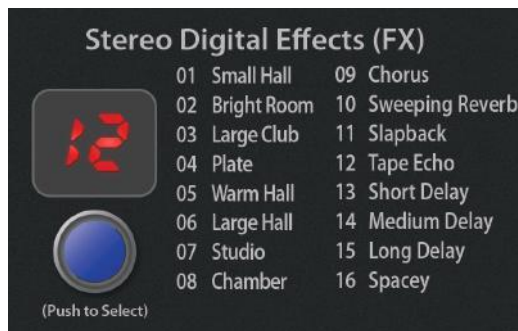

To select an effects preset, simply turn the encoder until the desired preset number is displayed and press the encoder.

Preset Descriptions and Uses

No.	Name	Description	When to Use
1	Small Hall	Adds a medium reverb time to emulate a small concert hall	<ul style="list-style-type: none"> • Gives vocals and instruments a “big” vibe • Adds a greater sense of space
2	Bright Room	Emulates the sound of large room with hard surfaces to provide many early reflections	<ul style="list-style-type: none"> • Adds life to a flat room • Helps a vocal or instrument stand out in a mix
3	Large Club	Warm and full reverb to emulate the sound of a large acoustic venue	<ul style="list-style-type: none"> • All purpose reverb for overall mixes
4	Plate Reverb	Emulates a vintage plate reverb by providing many early reflections without pre-delay	<ul style="list-style-type: none"> • Fattens up percussion and backing vocals
5	Warm Hall	Emulates a large concert hall with softer surfaces	<ul style="list-style-type: none"> • Adds rich fullness to acoustic instruments and solo vocals
6	Large Hall	Provides long pre-delay and reverb time	<ul style="list-style-type: none"> • Gives acoustics instruments and vocals a “larger than life” feel
7	Studio	Emulates an acoustically treated studio room to provide a more intimate and warmer tone	<ul style="list-style-type: none"> • Soften harsh instruments • Gives vocals a lush vibe • Adds subtle ambience to a mix
8	Chamber	Emulates a large cathedral by adding long pre-delays and reflections	<ul style="list-style-type: none"> • Adds a rich, ethereal feel to any instrument
9	Chorus	Plays with the phase of the signal to create a modulated, sweeping effect	<ul style="list-style-type: none"> • Good effect for electric guitar and keyboards for a vintage vibe
10	Sweeping Reverb	Adds a rich reverb to a chorus effect	<ul style="list-style-type: none"> • Thickens and enhances instruments
11	Slapback	Adds a single, relatively quick delay of the original signal to emulate vintage tape-based delay units	<ul style="list-style-type: none"> • Vintage sound for guitars • Fun effect for vocals
12	Tape Echo	This medium-length, clean delay emulates the traditional tape echo	<ul style="list-style-type: none"> • Great for vocals and guitars for a retro vibe
13	Short Delay	Provides 300 ms delay	<ul style="list-style-type: none"> • Helps a vocal or guitar cut through a mix
14	Medium Delay	Provides 380 ms delay	<ul style="list-style-type: none"> • Adds drama to a vocal or sample
15	Long Delay	Provides 480 ms delay	<ul style="list-style-type: none"> • Subtle, dreamy effect for vocals and instruments
16	Spacey	Combines a large room reverb with a long delay	<ul style="list-style-type: none"> • Because Purple Rain

3.5.2 Internal FX Bus Return



The internal FX return allows you to adjust the amount of the effects output you would like in your main and monitor mixes.

1. **Monitor sends.** These are the level controls for the effects output in each monitor mix. The AR22 USB, AR16 USB and AR12 USB provide two monitor mixes; the AR8 USB provides one monitor mix. *See Section 3.4.2* for more information on creating monitor mixes.
2. **Balance.** This sets the FX return's position in the main stereo mix.
3. **Mute button.** This button will mute or unmute the FX return. The LED to the left of it will illuminate red when the monitor output is muted.

Power User Tip: Mute the FX return during performance breaks while the band is speaking to the audience to create a more professional show.

4. **FX level.** Adjusts the master level of the effects output in your main mix.

3.5.3 Creating Internal Effects Mixes

There are at least two main advantages to creating an effects mix, rather than inserting an effect in a channel. First, several channels can be sent to a single processor. In addition to greatly simplifying the number of parameters you have to control, this can create a cohesive sound in your mix. The second advantage of creating an effects mix is that you can vary the level sent from each channel to the processor, rather than patching the output directly into the effect. This allows you to add a lot of or a little of an effect to any given channel.

Your StudioLive AR-series mixer's internal effects bus is used much in the same way the monitor buses are used to create monitor mixes.

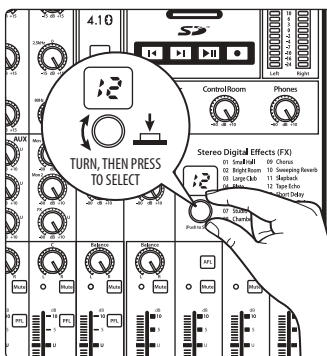

1. To begin, select the effects preset you would like to use by turning the Effects encoder to the desired number and pressing the encoder.

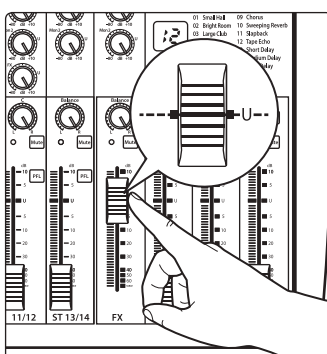

2. Raise the FX return output level to unity.

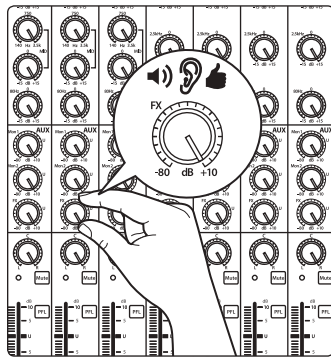

- Use the FX send controls on each channel the same way that you use the faders to set the output level to your main mix. The higher a channel's level is in the effects mix, the more processed ("wetter") it will sound.

Let's say that you are using reverb to liven up a relatively dead room. You might send a little bit of each input to the reverb, but you probably will not want much of the drums and bass to be processed, as too much reverb could reduce their impact and leave your mix without a sturdy foundation. So rather than turning the FX-send level for the kick drum channel all the way up, turn it to the 8 or 9 o'clock position, so that its saturation is between 20% and 30%. This way, only a small portion of the kick-drum input will be affected by the reverb.

- Use the FX return level fader to increase or decrease the overall effects mix in the Mains to taste.
- To send the FX return mix to a monitor mix, adjust the FX return's monitor send control to taste.

3.5.4 Using an External Effects Processor

This section will detail how to use an external effects processor, bypassing your StudioLive AR mixer's internal processor.

- To begin, connect the FX output to the input of your external effects processor and connect the outputs of your processor to a stereo channel on your StudioLive AR.

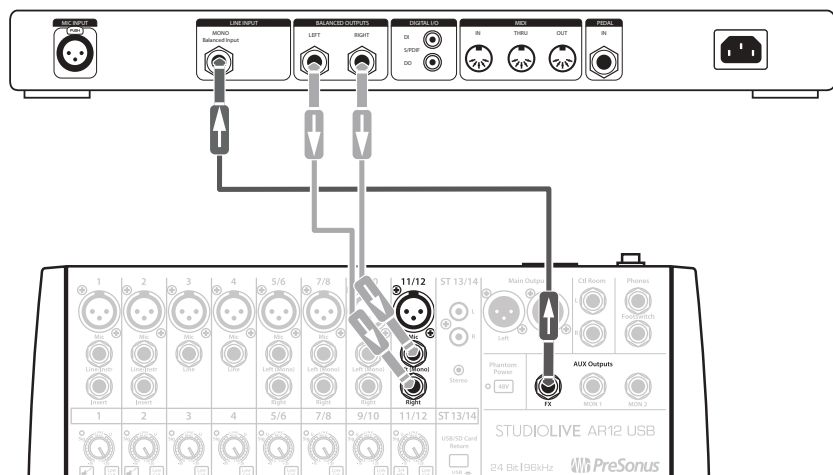

- Turn up the output level of the stereo channel to unity.
- Use the FX send controls on each channel the same way that you use the faders to set the output level to your main mix. The higher a channel's level is in the effects mix, the more processed ("wetter") it will sound.
- Use the stereo channel's Level control to increase or decrease the overall effects mix in the Mains to taste.
- To send the FX return mix to a monitor mix, adjust the stereo channel's monitor send control to taste.

Power User Tip: You can also use the FX output to create an additional monitor mix when multiple monitor mixes are of greater importance than adding effects.

3.6 Master Section Controls

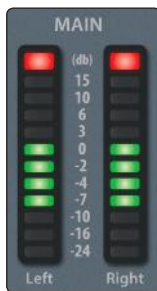

1. **USB 1-2 Send.** By default, the main mix can be recorded to your computer on the last USB send pair (21-22 / 17-18 / 13-14 / 7-8). If you are only recording the main mix on your computer, engaging the USB 1-2 Send button will simplify setup in most situations.

Note: When this button is enabled, Channels 1 and 2 cannot be recorded individually, although they will still be a part of the Main mix.

2. **Main Mute button.** This button will mute or unmute the Main bus. The LED to the left of it will illuminate red when the main outputs are muted.

Power User Tip: Muting the main mix during performance breaks is a quick and easy way to prevent accidental signal spikes or feedback.

3. **Output-level control.** Adjusts the master level of the Main output.

4. **Main output meters.** These peak meters display the output levels of the main stereo bus. These meters are scaled from -24 to +15 dBu. For best performance, the highest level of your mix should stay between the "0" and "+6" indicators.

Because the StudioLive AR main outputs are electrical, rather than digital, it is more advantageous to meter them relative to voltage. The Main meters display signals from -24 to +15 dBu (-42 to -3 dBFS). This means that if you play back a digital signal over USB or from the SD card at -18 dBFS, it will register in the Main meters as 0 dBu. Conversely if you record a signal over USB that registers at 0 dBu in the Main Meters, it will display at -18 dBFS in any application that meters in dBFS.

3.6.1 Control Room Levels

StudioLive AR-series mixers feature a headphone output and control-room outputs, allowing you to listen to the main mix and the Solo bus. Whenever a channel is soloed, it will automatically be routed to the control room and headphone outputs. When no channel is soloed, the main mix will be heard through these outputs.



1. **Solo Master knob.** Adjusts the overall level of the Solo bus.
2. **Control Room knob.** Adjusts the overall level of the control-room monitor outputs.
3. **Phones knob.** Adjusts the overall level of the headphone output.

3.7 Typical Band Setup Diagram

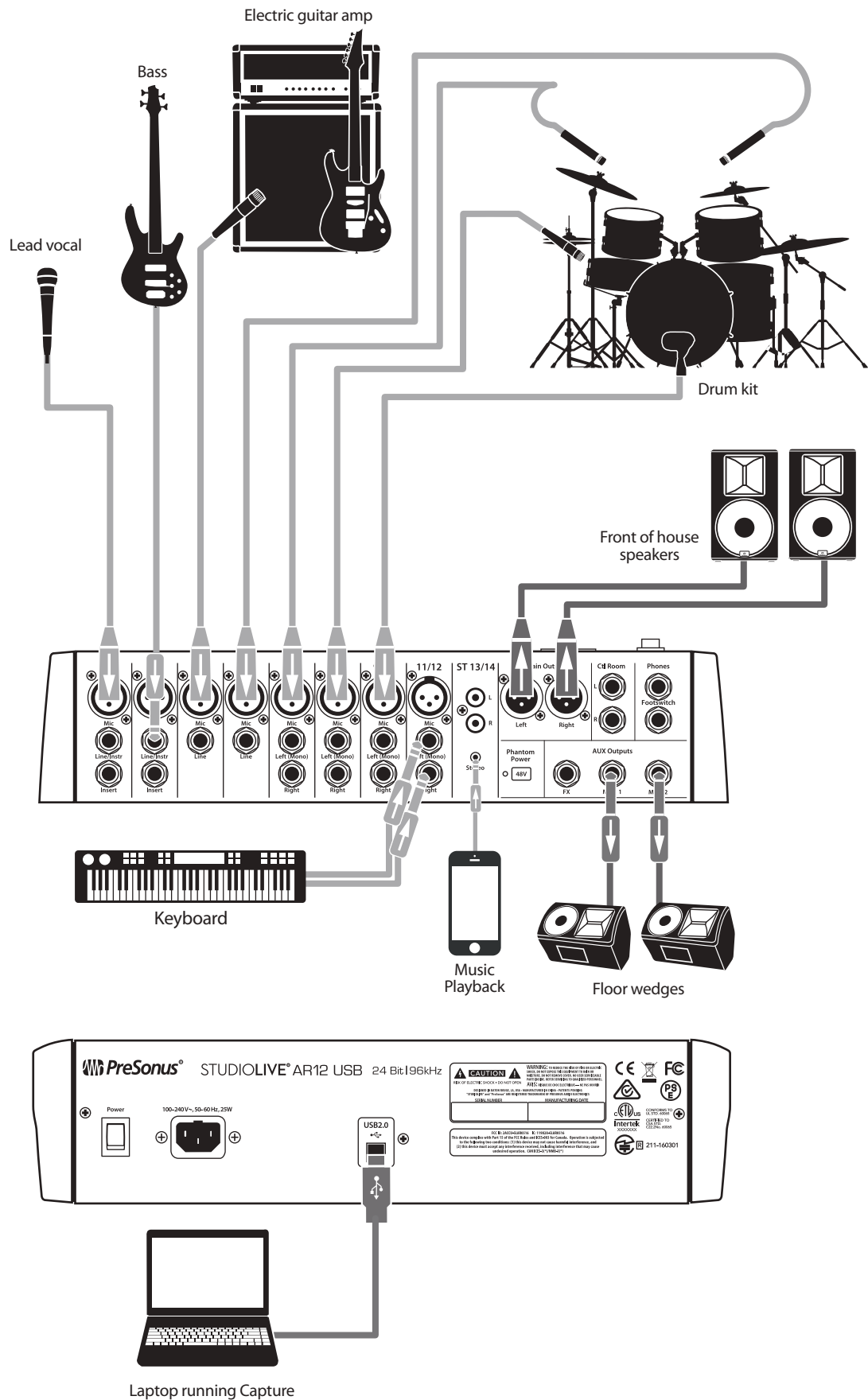

3.8 Typical Home Studio Setup Diagram

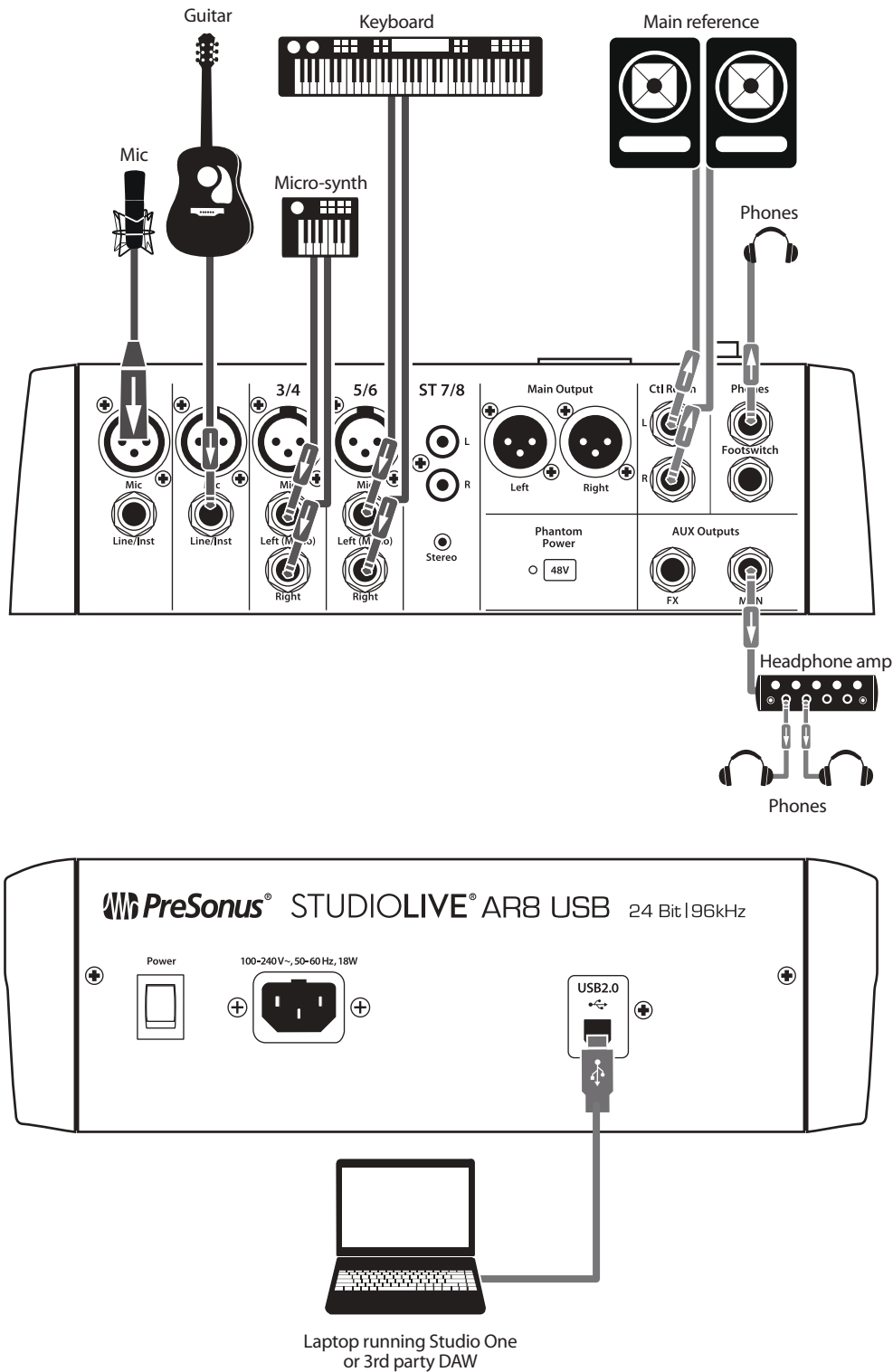

4 SD Recording and Playback

StudioLive AR-series mixers are equipped with an onboard stereo SD recorder that allows you to record the main mix as a stereo WAV file to any FAT16-formatted SD card or FAT32-formatted SDHC card. You can also load stereo WAV and MP3 files onto an SD or SDHC card to play audio during a show.

4.1 SD Recording

This section explains on how to record the main mix as a stereo WAV file:

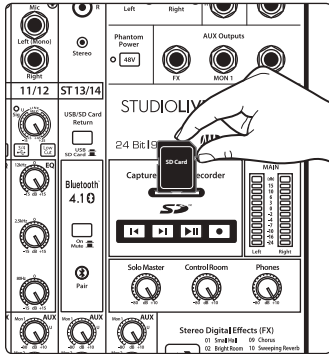

1. Insert a FAT16-formatted SD card or FAT32-formatted SDHC card into your StudioLive AR mixer. An SD card will provide up to 2 GB of storage space. An SDHC card will provide up to 32 GB.

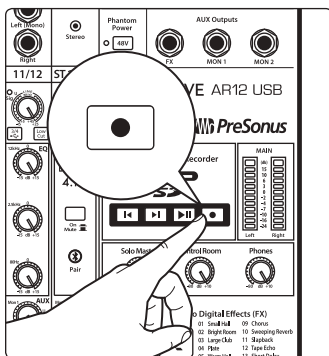

2. Press the Record button.

3. Recording will begin when the Play/Pause and Record buttons are both illuminated.

If no SD card is recognized, the Record button will flash three times.

4. Press the Play/Pause button to stop the recording.

Once complete, you can transfer your recordings onto your computer by inserting the SD card into your computer's SD card reader and copying the files to your computer's hard drive. Each file will be labeled with an "SL-AR" heading, followed by a number.

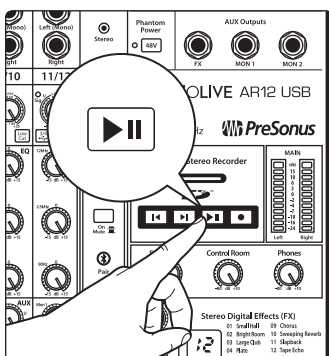

4.2 SD Playback

Playing files from the SD card is a great way to listen to a performance right away, and it can be useful during a performance. SD cards can be preloaded with backing tracks for performance or rehearsal. Or load an SD card with your favorite break music and never be caught without the right adapter or cable again.

To play audio from your SD recorder:

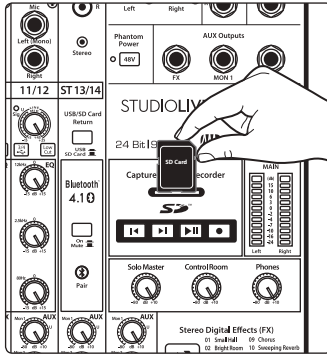

1. Insert into your StudioLive AR mixer a FAT16-formatted SD card or FAT32-formatted SDHC card that has been pre-loaded with WAV or MP3 files or that you have recorded to using your StudioLive AR mixer.

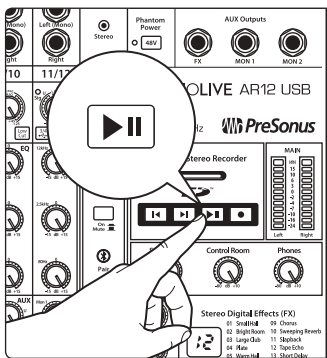

2. Press the Play/Pause button. The current stereo audio file will begin to play at the last position. Playback will continue through all files, in alphanumeric order, until the end of the last file has been reached; then playback will stop automatically.

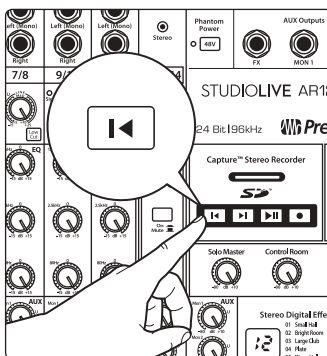

3. Press the Play/Pause button again to pause playback at the current file position.
4. Press the Return to Zero button to restart the current audio file. Press again to move to the beginning of the previous file.

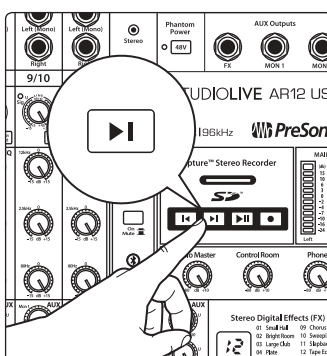

5. Press the Go to End button to advance playback to the end of the current audio file. Press again to move to the end of the next file.

5 Resources

5.1 EQ Frequency Guides

Table 1

Instrument	What to Cut	Why to Cut	What to Boost	Why to Boost
Human Voice	7 kHz	Sibilance	8 kHz	Big sound
	2 kHz	Shrill	3 kHz and above	Clarity
	1 kHz	Nasal	200-400 Hz	Body
	80 Hz and below	Popping P's		
Piano	1-2 kHz	Tinny	5 kHz	More presence
	300 Hz	Boomy	100 Hz	Bottom end
Electric Guitar	1-2 kHz	Shrill	3 kHz	Clarity
	80 Hz and below	Muddy	125 Hz	Bottom end
Acoustic Guitar	2-3 kHz	Tinny	5 kHz and above	Sparkle
	200 Hz	Boomy	125 Hz	Full
Electric Bass	1 kHz	Thin	600 Hz	Growl
	125 Hz	Boomy	80 Hz and below	Bottom end
String Bass	600 Hz	Hollow	2-5 kHz	Sharp attack
	200 Hz	Boomy	125 Hz and below	Bottom end
Snare Drum	1 kHz	Annoying	2 kHz	Crisp
			150-200 Hz	Full
			80 Hz	Deep
Kick Drum	400 Hz	Muddy	2-5 kHz	Sharp attack
	80 Hz and below	Boomy	60-125 Hz	Bottom end
Toms	300 Hz	Boomy	2-5 kHz	Sharp attack
			80-200 Hz	Bottom end
Cymbals	1 kHz	Annoying	7-8 kHz	Sizzle
			8-12 kHz	Brilliance
			15 kHz	Air
Horns	1 kHz	Honky	8-12 kHz	Big sound
	120 Hz and below	Muddy	2 kHz	Clarity
String section	3 kHz	Shrill	2 kHz	Clarity
	120 Hz and below	Muddy	400-600 Hz	Lush and full

Table 2

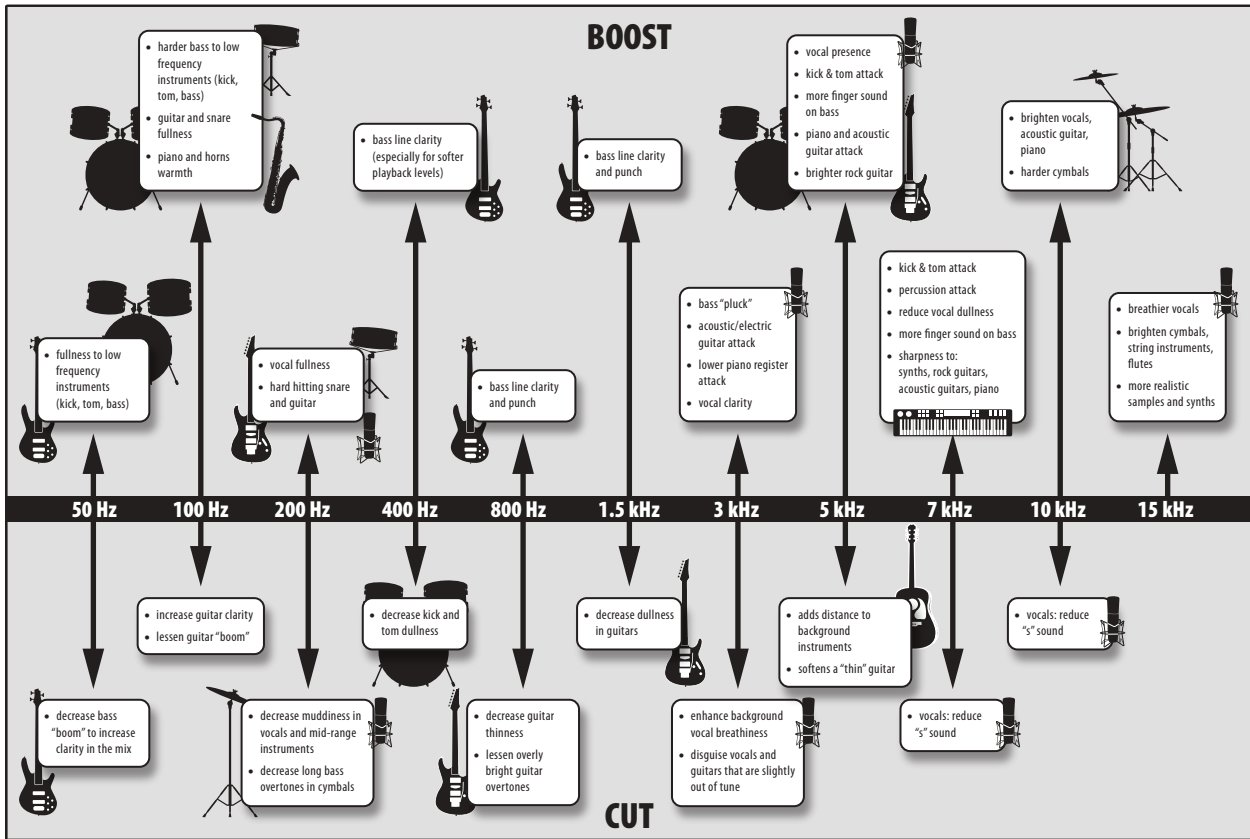

5.2 Block Diagrams

5.2.1 StudioLive AR22, AR16 USB, and AR12 USB Block Diagram

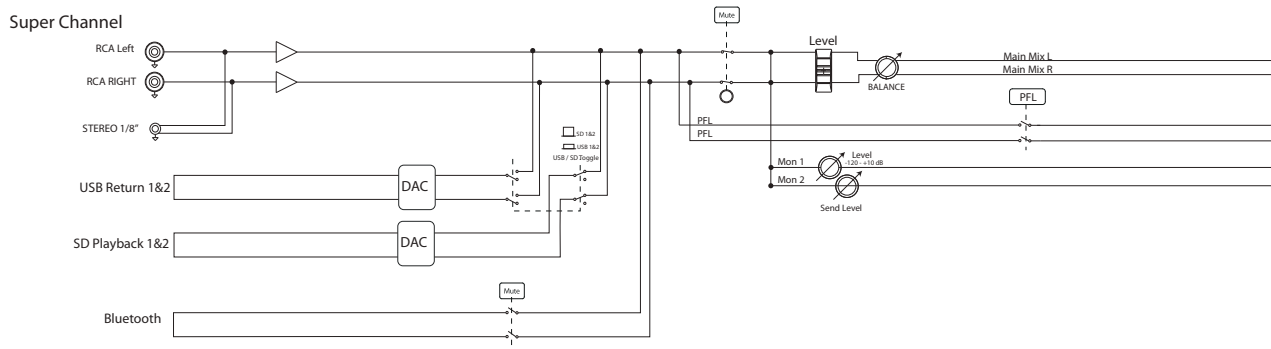
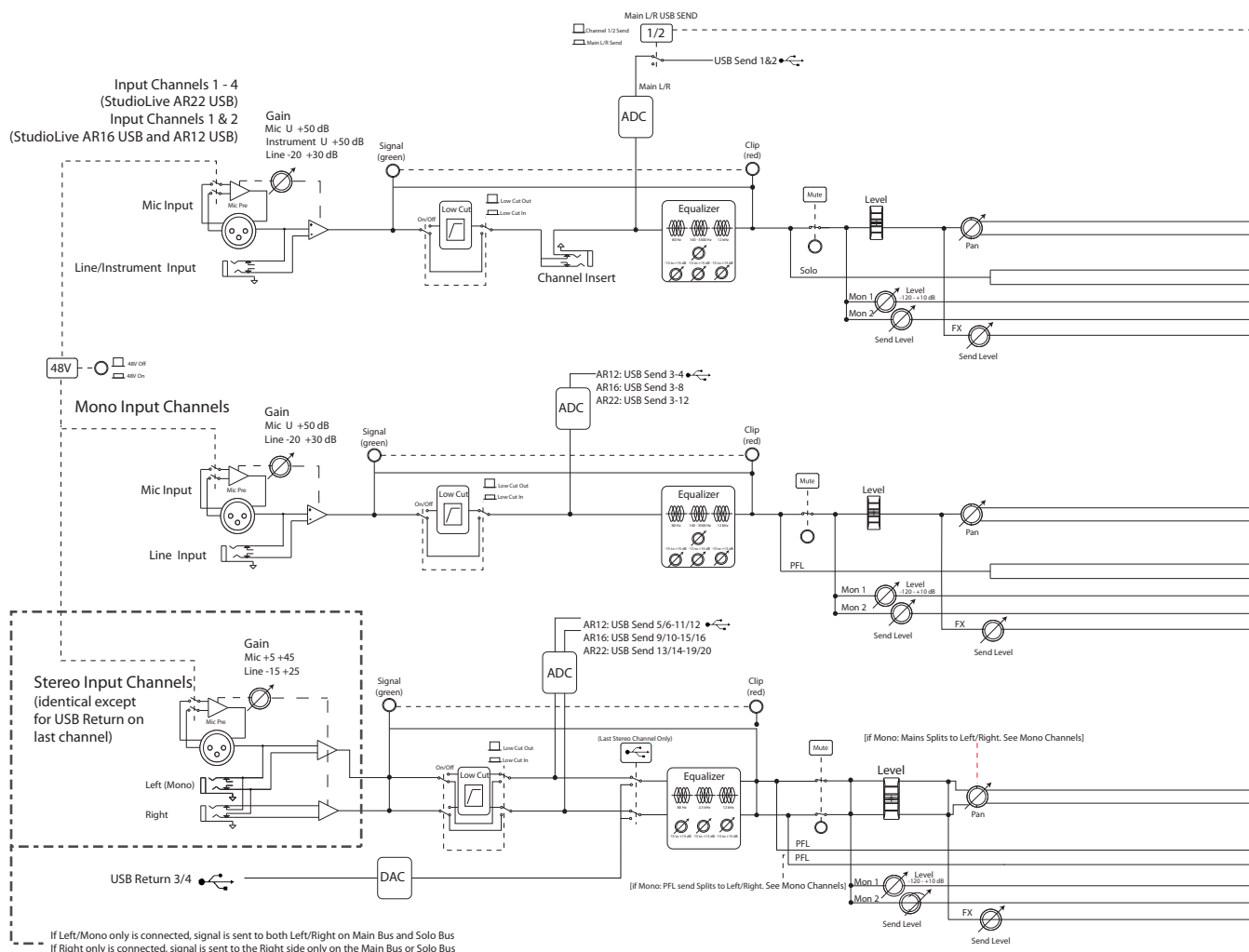

NOTE: All switches are shown in the default (up) position

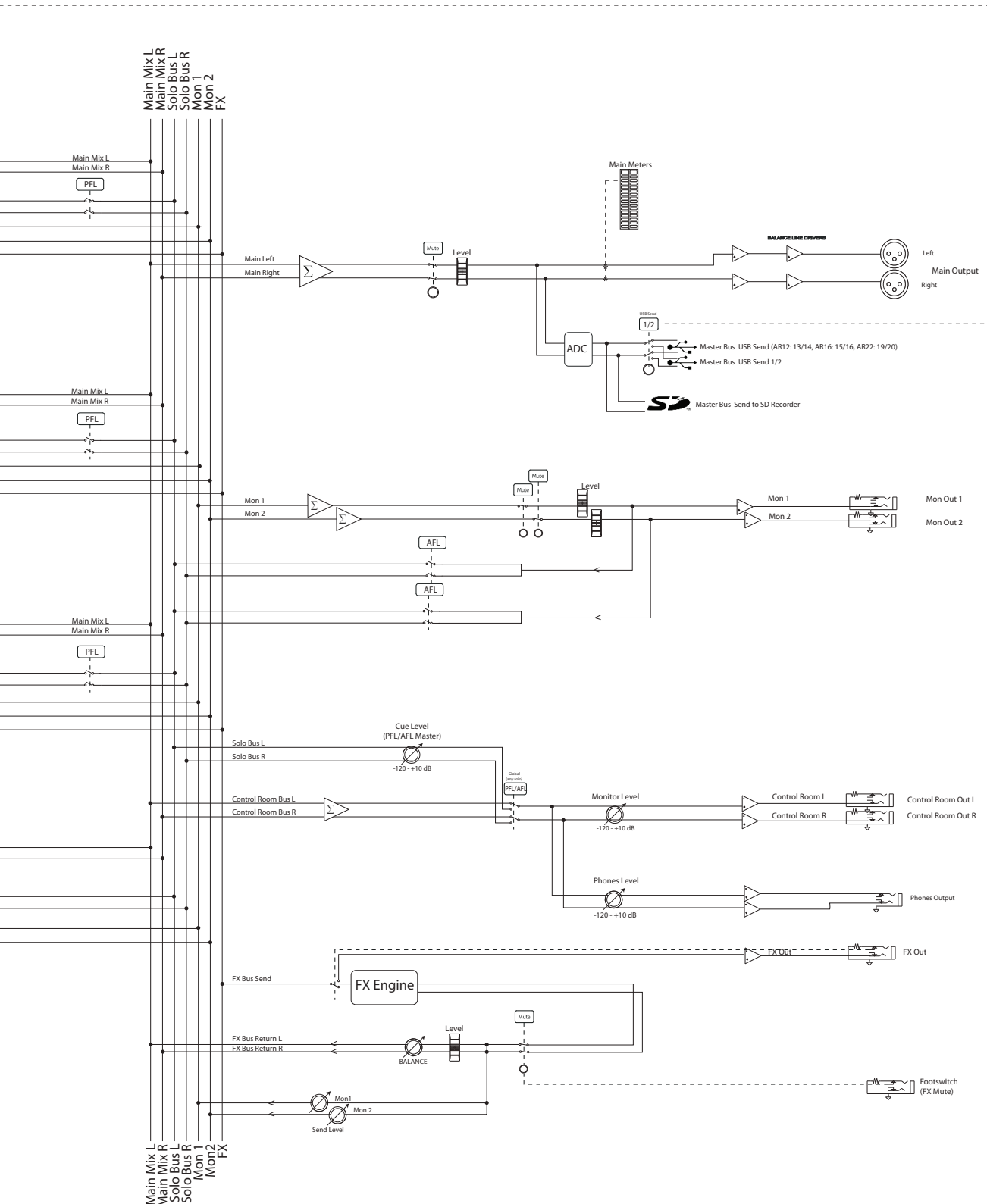

StudioLive™ AR22 USB, AR16 USB & AR12 USB BLOCK DIAGRAM

Rev Number 06/30/2017

5.2.2 StudioLive AR8 USB Block Diagram

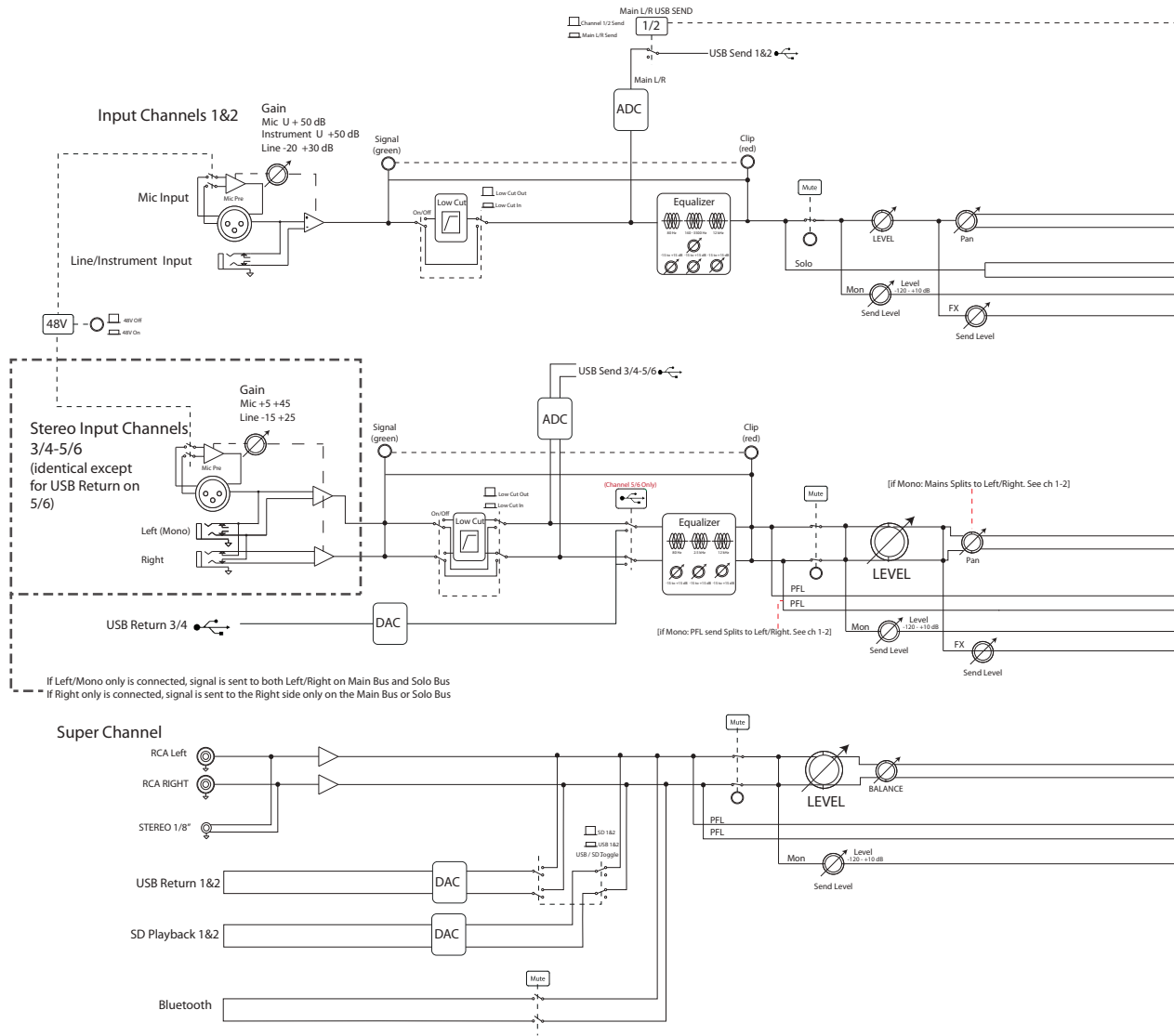

NOTE: All switches are shown in the default (up) position

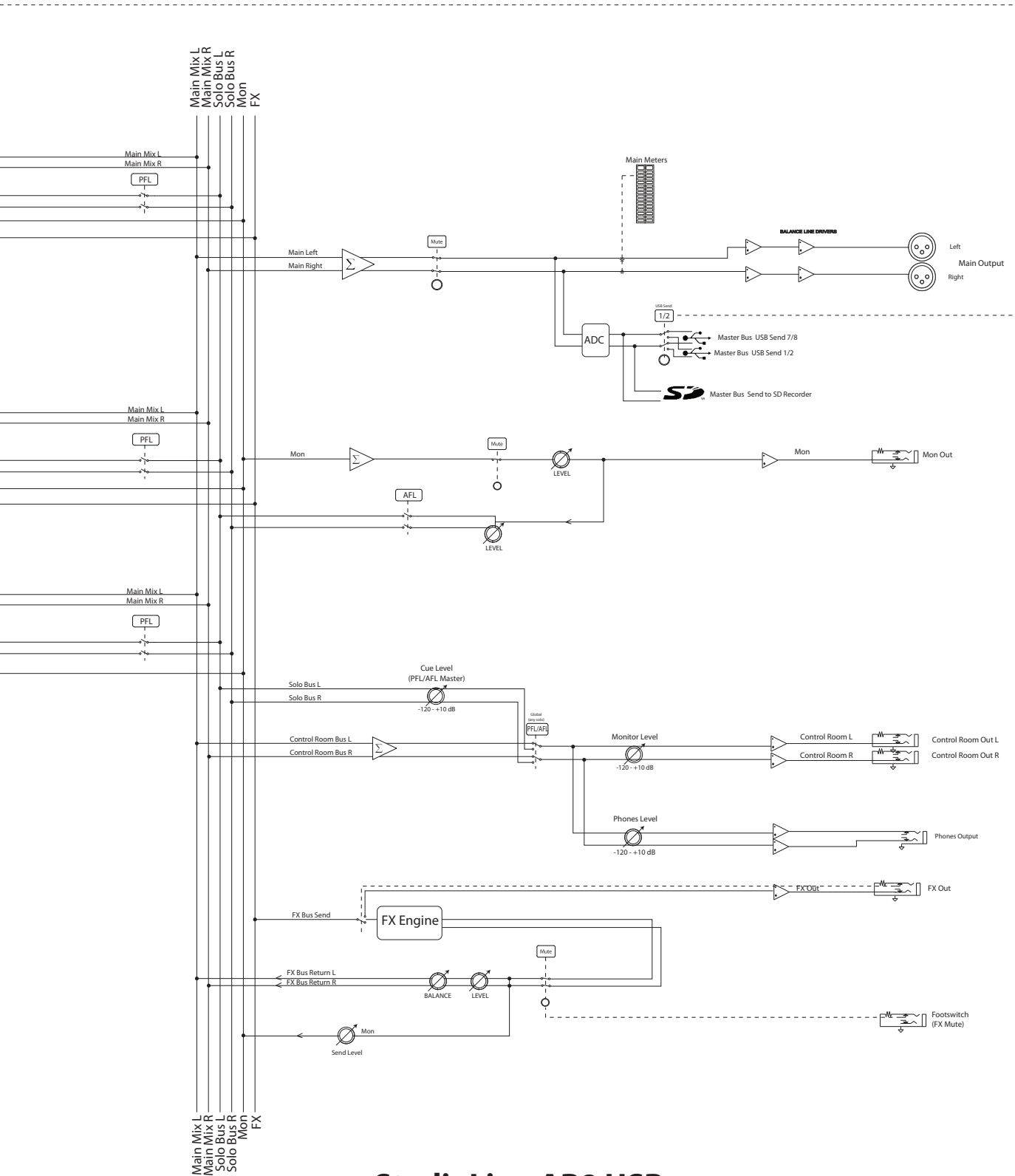

StudioLive™ AR8 USB
BLOCK DIAGRAM
Rev Number 12/4/2015

5.3 Recall Sheets

5.3.1 AR22 USB, AR16 USB and AR12 USB Recall Sheet

CHANNEL NUMBER	CHANNEL NUMBER	CHANNEL NUMBER	CHANNEL NUMBER	CHANNEL NUMBER	CHANNEL NUMBER	CHANNEL NUMBER	CHANNEL NUMBER	ADDITIONAL NOTES
INSTRUMENT/MIC	INSTRUMENT/MIC	INSTRUMENT/MIC	INSTRUMENT/MIC	INSTRUMENT/MIC	INSTRUMENT/MIC	INSTRUMENT/MIC	INSTRUMENT/MIC	

CHANNEL NUMBER	CHANNEL NUMBER	CHANNEL NUMBER	CHANNEL NUMBER	SOURCE	Main Output			Ctl Room	Phones				
INSTRUMENT/MIC <input type="checkbox"/> Stereo <input type="checkbox"/> Mono	INSTRUMENT/MIC <input type="checkbox"/> Stereo <input type="checkbox"/> Mono	INSTRUMENT/MIC <input type="checkbox"/> Stereo <input type="checkbox"/> Mono	INSTRUMENT/MIC <input type="checkbox"/> Stereo <input type="checkbox"/> Mono		Left			L					
Mic	Mic	Mic	Mic	L	Right			R	Footswitch				
Left (Mono)	Left (Mono)	Left (Mono)	Left (Mono)	NOTE	NOTE			NOTE					
Right	Right	Right	Right		Phantom Power			AUX Outputs					
					<input type="checkbox"/> 48V			FX	MON 1	MON 2			
					NOTE			NOTE		NOTE			
				USB/SD Card Return	Capture™ Stereo Recorder								
				<input type="checkbox"/> USB <input type="checkbox"/> SD Card	CARD NAME								
				Bluetooth™ 4.1	MAIN								
				<input type="checkbox"/> On <input type="checkbox"/> Off	15 (db)								
				<input type="checkbox"/> Pair	10								
					6								
					3								
					0								
					-2								
					-4								
					-7								
					-10								
					-16								
					-24								
					Left								
					Right								
					Solo Master			Control Room			Phones		
					-80 dB +10			-80 dB +10			-80 dB +10		
					ENTER PRESET NUMBER								
					01 Small Hall								
					02 Bright Room								
					03 Large Club								
					04 Plate								
					05 Warm Hall								
					06 Large Hall								
					07 Studio								
					08 Chamber								
					09 Chorus								
					10 Sweeping Reverb								
					11 Slapback								
					12 Tape Echo								
					13 Short Delay								
					14 Medium Delay								
					15 Long Delay								
					16 Spacey								
					Balance			Balance			USB Send		
					L R			L R			<input type="checkbox"/> 1/2		
					Mute			Mute			Mute		
					dB								
					10								
					5								
					U								
					-5								
					-10								
					-20								
					-30								
					-40								
					-50								
					-60								
					∞								

5.3.2 AR8 USB Recall Sheet

INSTRUMENT/MIC		INSTRUMENT/MIC		INSTRUMENT/MIC		INSTRUMENT/MIC		SOURCE		Main Output		Ctl Room		Phones		
1	2	3/4	5/6	ST	7/8	Left		Right		L	R	Footswitch				
Mic	Mic	Mic	Mic			L		R		NOTE		NOTE		NOTE		
Line/Inst	Line/Inst	Left (Mono)	Left (Mono)			Stereo				Phantom Power		AUX Outputs				
		Right	Right							48V	FX	MON	NOTE		NOTE	
1	2	3/4	5/6	ST	7/8											
Sig	Sig	Sig	Sig	USB/SD Card Return	USB SD Card											
Low Cut	Low Cut	Low Cut	Low Cut	Bluetooth™ 4.0	On Mute											
EQ	EQ	EQ	EQ	Pair												
12kHz	12kHz	12kHz	12kHz													
25kHz	25kHz	25kHz	25kHz													
80Hz	80Hz	80Hz	80Hz													
AUX	AUX	AUX	AUX													
Mon	Mon	Mon	Mon													
FX	FX	FX	FX													
C	C	C	C	Balance	Balance	AFL		Mute		USB Send						
L	L	L	L	L	R	Mute				T/2		Mute				
Mute	Mute	Mute	Mute													
-80 dB +10	-80 dB +10	-80 dB +10	-80 dB +10	-80 dB +10	-80 dB +10											
1 PFL	2 PFL	3/4 PFL	5/6 PFL	ST/7/8 PFL	FX	MON		MAIN								

5.4 Technical Specifications

Microphone Preamp

Type	XLR Female, Class A
Maximum Input level (unity gain)	+18 dBu (Mono Channels), +5 dBu (Stereo Channels) +/- 1.0 dB
Gain Control Range	Mono Channels: 50 dB, ±1 dB (Unity to +50 dB), Stereo Channels: 40 dB +/- 1 dB (+5 to +45 dB)
Frequency Response to Analog Outputs	20 Hz to 20 kHz, +0.5/-1.5 dB
Frequency Response to USB (Direct)	20 Hz to 20 kHz, +0.5/- 1.5 dB
S/N Ratio to Outputs (+4 dBu)	89 dB
THD+N (min. gain, A-wtd)	< 0.01%
Input Impedance	1 kΩ
EIN (+55 dB gain, 150Ω input, 20 Hz-22 kHz, A-wtd)	Mono Channels: <128 dBu Stereo Channels: <120 dBu
Common Mode Rejection Ratio (1 kHz, +55 dB gain)	65 dB
Phantom Power	+48 V, ±3V, Global

*Note: All channel inputs sum through mic preamp.

Instrument Inputs

Type	¼" TS Female, Unbalanced, Hi-Z
Maximum Input Level (min. gain, 1 kHz@0.5% THD+N)	+12 dBu ±1.0 dB
Gain Control Range	50 dB, ±1 dB (Unity to +50 dB)
Frequency Response to Analog Outputs	20 Hz to 20 kHz, +0.5/-1.5 dB
Frequency Response to USB (Direct)	20 Hz to 20 kHz, +0.5/-1.5 dB
Dynamic Range (min. gain, A-wtd)	> 105 dB
Dynamic Range (mid. Gain, unwtd)	> 108 dB
THD+N (1 kHz, -1 dBFS, A-wtd)	< 0.01%
THD+N (1 kHz, -1 dBFS, unwtd)	< 0.01%
Input Impedance	> 1 MΩ

*Note: All Channel Inputs sum through Mic preamp.

Line Inputs

Type	¼" TRS Female, Balanced
Maximum Input Level (min. gain, 1 kHz@0.5% THD+N)	Mono Channels: +18 dBu, +/-1.0 dB Stereo Channels: +22 dBu, +/-1.0 dB
Gain Control Range	Mono Channels: 50 dB, +/- 1 dB (-20 to +30 dB), Stereo Channels: 40 dB, +/- 1 dB (-15 to +25 dB)
Frequency Response to Analog Outputs	20 Hz to 20 kHz, +0.5/-1.5 dB
Frequency Response to USB (Direct)	20 Hz to 20 kHz, +0.5/-1.5 dB
S/N Ratio to Analog Outputs (+4 dBu)	82 dB
THD+N (1 kHz, -1 dBFS, A-wtd)	< 0.01%
Input Impedance (Balanced)	10 kΩ

*Note: All Channel Inputs sum through Mic preamp.

Main, Control Room, Monitor, and FX Outputs

Type (Main Outputs)	XLR Male, Impedance Balanced
Type (Control Room, Monitor, FX Outputs)	¼" TRS Female, Balanced
Rated Output Level (Main Outputs)	+24 dBu, ±1.0 dB
Rated Output Level (Control Room, Monitor, FX Outputs)	+18 dBu
Frequency Response	20 Hz to 20 kHz, +0.5/-1.5 dB
Dynamic Range (A-wtd)	> 108 dB
THD+N (Bandwidth 20~20 kHz, -1 dBFS, unwtd)	< 0.01%
Output Impedance	100 Ω

Headphone Output

Type	¼" TRS Female, Stereo, Unbalanced
Maximum Output Level	150 mW/channel @ 56Ω
Frequency Response	20 Hz to 20 kHz, +0.5/-1.5 dB
Dynamic Range (a-wtd)	> 103 dB
THD+N (Bandwidth 20~20 kHz, -1 dBFS, unwtd)	< 0.01%

System Crosstalk

Input to Output (Ref = +4 dBu, 20 Hz to 20 kHz, unwtd)	-86 dBu
Adjacent Channels (Ref = +4 dBu, 20 Hz to 20 kHz, unwtd)	-80 dBu

Signal Level LED

Signal	-30 dBFS (pre-EQ)
Clip	-3.0 dB before clip (pre- or post-EQ)

Channel EQ

Low Cut	100 Hz, -18 dB/octave
High Shelving	±15 dB @ 12 kHz
Mid Peaking (Mono Channels: AR16 USB, AR12 USB)	±15 dB @ 140 Hz to 3.5 kHz (variable)
Mid Peaking (Stereo Channels: AR16 USB, AR12 USB, All: AR8 USB)	±15 dB @ 2.5 kHz
Mid-Band Q	Boost: 0.55, Cut: 2.5
Low Shelving	±15 dB @ 80 Hz

Audio Interface

Host Interface	USB 2.0
ADC Dynamic Range (Component)	114 dB
DAC Dynamic Range (Component)	114 dB
Signal to Noise (A-wtd):	-96 dB
Bit Depth	24-bit
Internally Supported Sample Rates	44.1, 48, 88.2, 96 kHz
Jitter	<80 ps RMS (20 Hz – 20 kHz)
Jitter Attenuation	>60 dB (1 ns in => 1 ps out)

SD Recorder

Supported Media Format	FAT16-formatted SD Card, FAT32-formatted SDHC Card
Media Storage Capacity	SD Card: 2 GB, SDHC Card: 32 GB
Recording File Format	Stereo WAV
Playback File Formats	Stereo WAV, MP3
Sampling Rate (WAV)	44.1 kHz
Bit Depth	Recording: 24-bit, Playback: 16- and 24-bit

Power

Connector	IEC
Input Voltage Range	90 to 240 VAC

Physical	AR22 USB	AR16 USB	AR12 USB	AR8 USB
Length	15.6" (397 mm)	15.6" (397 mm)	15.6" (397 mm)	12.3" (313 mm)
Width (chassis only)	22.8" (579 mm)	18.9" (480 mm)	15" (381 mm)	11" (284 mm)
Maximum Height	3.5" (89 mm)	3.5" (89 mm)	3.5" (89 mm)	3.5" (89mm)
Weight	TBD	14.1 lbs (6.4 kg)	11.9 lbs (5.4 kg)	7.1 lbs (3.2 kg)

Global Warming

Recommended Ambient Operating Temperature	0° to 40° Celsius / 32° to 104° Fahrenheit
---	--

6 Troubleshooting and Warranty

6.1 Troubleshooting

Please check the PreSonus Web site (www.presonus.com) regularly for software information and updates, firmware updates, and support documentation, including frequently asked questions.

Online technical support is available from within your My PreSonus account.

PreSonus telephone technical support is available to customers in the USA on Monday through Friday from 9 a.m. to 5 p.m. Central Time by calling 1-225-216-7887. Customers outside of the USA should contact their national or regional distributor for telephone technical support. A list of international distributors is provided at www.presonus.com/buy/international_distributors.

No Output on a Channel

Check the signal-present LED and verify that there is signal on that channel. If no signal is present, check the cable and the input source. Verify that the trim control is set at an appropriate level. Make sure the channel is not muted. Make sure that if your device requires phantom power, phantom power is engaged for the channel.

No Output on the Solo Bus While Monitoring

Verify that both the Cue volume and the headphone, or monitor, volume is at a reasonable level for comfortable listening and that the PFL button is engaged on the desired channels..

Can't Hear Main Mix in Headphones

Verify the headphone output control is at a sufficient level. Make sure that no PFL or AFL buttons are engaged.

Control Room Level Not Affecting Volume

Verify that your monitors are connected to the Control Room outputs of your StudioLive AR, not the Main outputs.

Main Fader Doesn't Control Mix Level

Verify that your monitors are connected to the Main outputs, not the Control Room outputs.

Microphone Preamp 1 or 2 Doesn't Pass Audio

First, verify that the Instrument input button is not engaged. This disables the microphone preamp. Next, verify that your microphone cable is operational and that the trim control is set at an appropriate level.

6.2 Warranty Information

PreSonus' warranty obligations for this hardware product are limited to the terms set forth below:

6.2.1 How Consumer Law Relates To This Warranty

THIS WARRANTY GIVES YOU SPECIFIC LEGAL RIGHTS, AND YOU MAY HAVE OTHER RIGHTS THAT VARY FROM STATE TO STATE (OR BY COUNTRY OR PROVINCE). OTHER THAN AS PERMITTED BY LAW, PRESONUS DOES NOT EXCLUDE, LIMIT OR SUSPEND OTHER RIGHTS YOU MAY HAVE, INCLUDING THOSE THAT MAY ARISE FROM THE NONCONFORMITY OF A SALES CONTRACT. FOR A FULL UNDERSTANDING OF YOUR RIGHTS YOU SHOULD CONSULT THE LAWS OF YOUR COUNTRY PROVINCE OR STATE.

PreSonus Products And EU Statutory Warranty

When you purchase PreSonus products, European Union consumer law provides statutory warranty rights in addition to the coverage you receive from the PreSonus limited warranty. A summary of the EU Statutory Warranty and the PreSonus Limited Warranty is below:

	EU Consumer Law	PreSonus Limited Warranty
Repair or Replacement Coverage For	Defects present when customer takes delivery	Defects arising after customer takes delivery
Warranty Period	2 years (minimum) from original date of purchase (unless superseded by PreSonus)	1 year from original date of purchase (unless superseded by PreSonus)
Cost of Coverage	Provided at no additional cost	Included at no additional cost
Who to contact to make a claim	The seller	PreSonus technical support for your region

What This Warranty Covers

PreSonus Audio Electronics, Inc., ("PreSonus") warrants defects in material and workmanship in PreSonus-branded products under normal use. This Limited Warranty applies only to hardware products manufactured by or for PreSonus that can be identified by the PreSonus trademark, trade name, or logo affixed to them.

Exclusions and Limitations

This warranty does **not** cover the following:

1. Damage caused by accident, abuse, improper installation, failure to follow instructions in the applicable owner's manual or improper operation, rental, product modification, alteration, or neglect.
2. Damage from improper grounding, faulty wiring (AC and signal), faulty equipment, or connection to a voltage range outside published specifications (see applicable owner's manual).
3. Damage to drivers or diaphragm assemblies found to have burnt voice coils from over/under driving or signal surge from another device.
4. Damage occurring during shipment or improper handling.
5. Damage caused by repair or service performed by persons not authorized by PreSonus.
6. Products on which the serial number has been altered, defaced, or removed.
7. Products purchased from an unauthorized PreSonus dealer (products that have transferable warranties are excluded from this provision provided the customer and the product are registered with PreSonus).

Who This Warranty Protects

This Warranty protects only the original retail purchaser of the product (products that have transferable warranties are excluded from this provision provided the customer and the product are registered with PreSonus)

How Long This Warranty Lasts

A 1-Year Limited Warranty begins on the original date of purchase from the retail purchaser.

What PreSonus Will Do

PreSonus will repair or replace, at our sole and absolute option, products covered by this warranty at no charge for labor or materials. If the product must be shipped to PreSonus for warranty service, the customer must pay the initial shipping charges. PreSonus will pay the return shipping charges.

How to Get Warranty Service (USA)

1. You must have an active user account with PreSonus and your hardware must be on file with your account. If you do not have an account, please go to <https://my.presonus.com> and complete the registration process.
2. Contact our Technical Support Department at (225) 216-7887 or log a support ticket at: <http://support.presonus.com>. TO AVOID THE POSSIBILITY OF SENDING IN A PRODUCT THAT DOES NOT HAVE A PROBLEM, ALL SERVICE REQUESTS SHALL BE CONFIRMED BY OUR TECH SUPPORT DEPARTMENT.
3. The return authorization number, as well as shipping instructions, shall be provided after your service request is reviewed and confirmed.
4. The product should be returned for service in the original product packaging. Products may be shipped in a manufactured "flight" or "road" style cases but PreSonus will NOT cover any shipping damage to these cases. Products that are not shipped in the original product package or a manufactured case may not receive a warranty repair, at PreSonus' sole discretion. Depending on the product model and the condition of your original packaging, your product may not be returned to you in the original packaging. The return shipping box may be a generic box that has been fitted for that model tested if the original gift box is not available.

How to Get Warranty Service (outside of USA)

1. You must have an active user account with PreSonus and your hardware must be on file with your account. If you do not have an account, please go to: <https://my.presonus.com> and complete the registration process.
2. Contact the Technical Support/Service Department for your region at www.presonus.com/buy/international_distributors and follow procedures provided by your PreSonus contact.

Limitation of Implied Warranties

ANY IMPLIED WARRANTIES, INCLUDING WARRANTIES OF MERCHANTABILITY AND FITNESS FOR A PARTICULAR PURPOSE, ARE LIMITED IN DURATION TO THE LENGTH OF THIS WARRANTY.

Some states, countries, or provinces do not allow limitations on how long an implied warranty lasts, so the above limitation may not apply to you.

Exclusion of Damages

PRESONUS'S LIABILITY FOR ANY DEFECTIVE PRODUCT IS LIMITED TO THE REPAIR OR REPLACEMENT OF THE PRODUCT, AT PRESONUS'S SOLE OPTION. IF PRESONUS ELECTS TO REPLACE THE PRODUCT, THE REPLACEMENT MAY BE A RECONDITIONED UNIT. IN NO EVENT WILL PRESONUS BE LIABLE FOR DAMAGES BASED ON INCONVENIENCE, LOSS OF USE, LOST PROFITS, LOST SAVINGS, DAMAGE TO ANY OTHER EQUIPMENT OR OTHER ITEMS AT THE SITE OF USE, AND, TO THE EXTENT PERMITTED BY LAW, DAMAGES FOR PERSONAL INJURY, OR ANY OTHER DAMAGES WHETHER INCIDENTAL, CONSEQUENTIAL OR OTHERWISE, EVEN IF PRESONUS HAS BEEN ADVISED OF THE POSSIBILITY OF SUCH DAMAGES.

Some states, countries, or provinces do not allow limitations on how long an implied warranty lasts, so the above limitation may not apply to you.

If you have any questions about this warranty or service received, please contact PreSonus (USA) at +1-225-216-7887 or contact one of our authorized international distributors at www.presonus.com/buy/international_distributors.

Product features, design, and specifications are subject to change without notice.

Added bonus: PreSonus' previously Top Secret recipe for...

Chicken and Andouille Gumbo

Ingredients:

- 1 C All-Purpose flour
- ¾ C Vegetable Oil
- 1 large onion (diced)
- 1 small onion (quartered)
- 6 celery stalks (diced)
- 1 large green bell pepper (diced)
- 3 cloves garlic (2 minced, 1 whole)
- 1 lb link Andouille sausage
- 4 Chicken leg quarters
- 4 qt water
- 4 bay leaves
- 1 tsp thyme
- 1 tsp Old Bay seasoning
- 1-2 C frozen okra, sliced
- ¼ C fresh parsley, minced
- 6-8 eggs (optional)

Cooking Instructions:

1. In a large pot, combine whole chicken leg quarters, water, quartered onion, Old Bay, 2 bay leaves and 1 whole clove garlic. Cover and bring to a low boil. Simmer stock until chicken is falling off the bone. Remove the chicken and set aside. Discard the onion, bay leaves, and garlic, reserving the liquid.
2. In a heavy saucepan, heat 1 Tbsp of the oil on medium high heat and brown the andouille until it is cooked through. Set aside sausage for later.
3. In the same saucepan, add and heat remaining oil. Slowly add flour 1-2 Tbsp at a time, stirring continuously. Continue cooking and stirring the roux until it is a dark brown (it should look like melted dark chocolate). Be careful to not to get the oil too hot or the flour will burn and you'll have to start over.
4. Once roux has reached the correct color, add diced onion, celery, green pepper, and minced garlic. Cook until vegetables are very tender. Do not cover.
5. Slowly add 1 quart of chicken broth and bring to a low boil, stirring constantly.
6. Transfer roux mixture to a soup pot and bring to low boil. Do not cover, the roux will settle on the bottom of the pot and burn.
7. Add remaining chicken broth, bay leaves, and thyme. Simmer for 30 minutes.
8. While gumbo is simmering, debone and shred chicken and slice the andouille.
9. Add chicken and andouille to gumbo and return to a simmer. Simmer for 30-45 minutes.
10. Stir in frozen okra and parsley and bring to a rolling boil.
11. **Optional:** Crack one egg into a teacup and quickly pour into the boiling gumbo. Repeat with the other eggs being careful not to cluster them too closely. After all the eggs have risen back to the surface, reduce heat and simmer.
12. Correct seasoning with salt and pepper (red, white and/or black) if necessary.
13. Serve over rice with potato salad.

Serves 12

StudioLive™ AR-Series

Hybrid Digital/Analog Production Mixers

Owner's Manual

