



### Sennheiser Documentation App



or online at  
[www.sennheiser.com/download](http://www.sennheiser.com/download)  
 evolution wired\_



# e 602 II

#### Quick Guide

Kurzanleitung  
 Guide rapide  
 Guida rapida  
 Guía de inicio rápido  
 Guia rápido  
 Beknopte handleiding  
 Krótka instrukcja obsługi  
 Snabbguide

#### Kvikstartguide

Pikaohje  
 Γρήγορος οδηγός  
 Kısa Kılavuz  
 Краткая инструкция  
 快速指南  
 快速使用指南  
 クイックガイド  
 퀵 가이드

Sennheiser electronic GmbH & Co. KG

Am Labor 1, 30900 Wedemark, Germany  
[www.sennheiser.com](http://www.sennheiser.com)

Printed in Germany  
 Publ. 07/18, 581323/A01

## SENNHEISER

### Setup

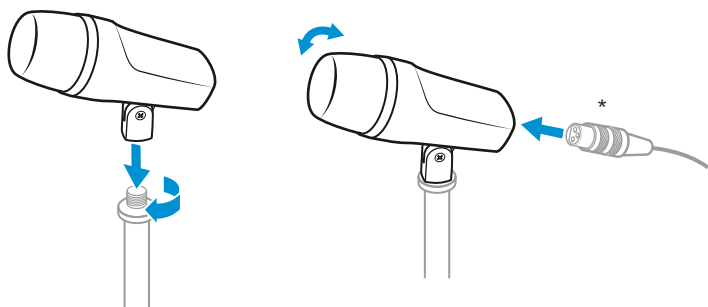

\*XLR-3 cable not included

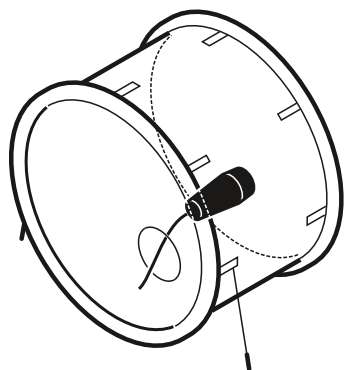

### In the box

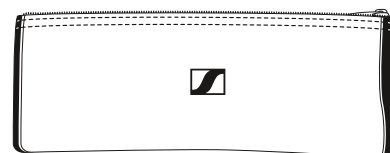
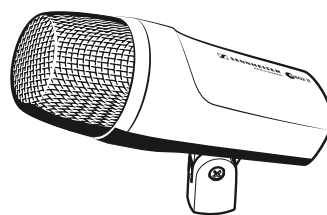

### Overview

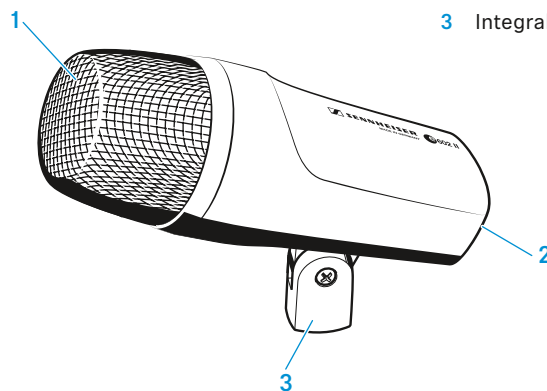

- 1 Sound inlet basket
- 2 XLR-3 connector
- 3 Integral stand mount

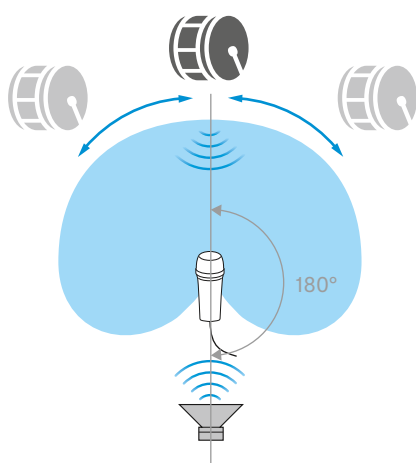

## Cleaning

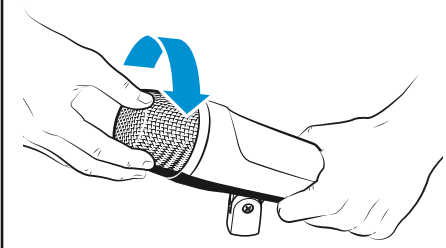
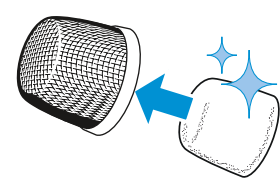
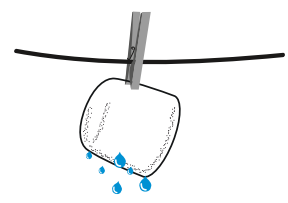
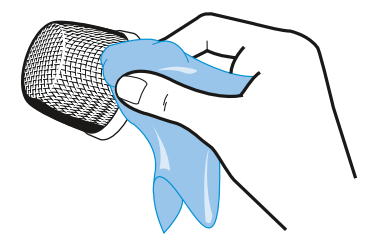
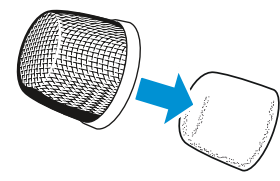
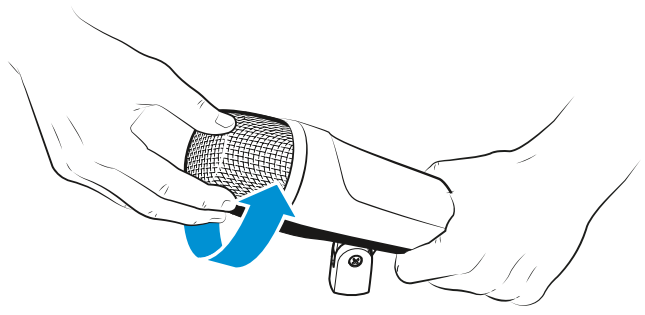

## Specifications

Transducer principle	dynamic
Frequency response	20 - 16,000 Hz
Pick-up pattern	cardioid
Sensitivity (free field)	0.9 mV/Pa (at 50 Hz) 0.25 mV/Pa (at 1 kHz)
Nominal impedance (at 1 kHz)	350 Ω
Min. terminating impedance	1 kΩ
Connector	XLR-3
Dimensions	∅ 60 x 153 mm
Weight	318 g

## Connector assignment

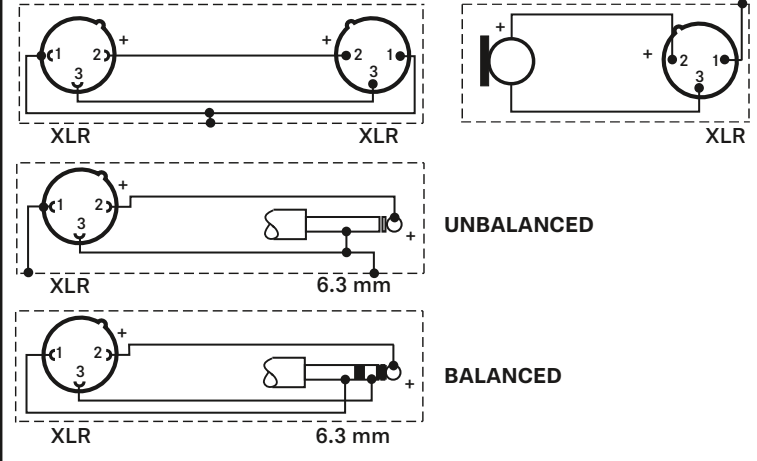

## Polar pattern and frequency response

