

# ZOOM®

# G1 FOUR/G1X FOUR

## Multi-Effects Processor

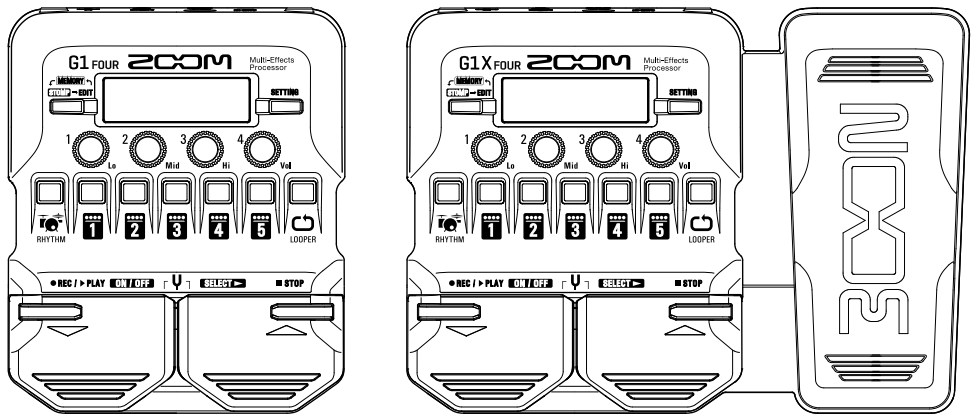

## Quick Guide

You must read the Usage and Safety Precautions before use.



The Operation Manual can be downloaded from the ZOOM website ([https://www.zoom.jp/docs/g1four\\_g1xfour](https://www.zoom.jp/docs/g1four_g1xfour)).

This page has files in PDF and ePub formats.

The PDF file format is suitable for printing and viewing on a computer.

The ePub file format is suitable for smartphones and tablets and can be read on electronic book readers.

© 2018 ZOOM CORPORATION

Copying or reprinting this manual in part or in whole without permission is prohibited.

Product names, registered trademarks and company names in this document are the property of their respective companies.

You might need this manual in the future. Always keep it in a place where you can access it easily.

The contents of this manual and the specifications of the product could be changed without notice.

Windows® is a trademark or registered trademark of Microsoft® Corporation.

Mac is a trademark or registered trademark of Apple Inc.

## Loading batteries

1. Open the battery compartment cover on the bottom of the product and insert 4 AA batteries.

### NOTE

By default, ECO mode setting is ON, so the power will automatically turn off if no use occurs for 10 hours.

ECO mode can also be set to "OFF" on the SETTING screen. (→ P.10)

## Connecting

1. Minimize the volume of the guitar amp.
2. Connect a guitar to the INPUT jack.
3. Connect a guitar amp or headphones to the OUTPUT jack.
4. Raise the guitar amp volume.

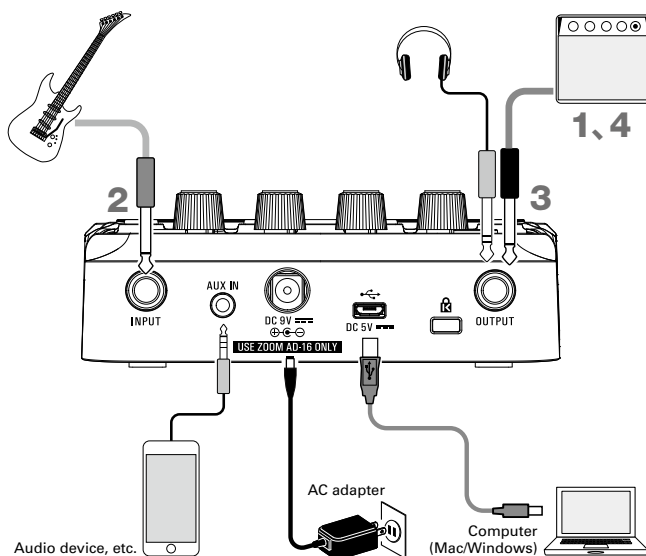

### HINT

- If a dedicated AC adapter (ZOOM AD-16) is connected, it can run on AC power.
- Power for operation can also be supplied through the USB port.
- By connecting an audio device, for example to the AUX IN jack, you can play along with another sound source.

Using the Mac/Windows Guitar Lab application, you can manage patches and edit and add effects.

## Selecting patches (MEMORY mode)

The **G1<sub>FOUR</sub>**/**G1X<sub>FOUR</sub>** is preloaded with 50 patches.  
Select patches to use in MEMORY mode.

### • Patches

These store effect ON/OFF states and parameter setting values. Effects are saved and recalled in units of patches.

### • Banks

These are groups of 10 patches.

The MEMORY mode screen opens when the **G1<sub>FOUR</sub>**/**G1X<sub>FOUR</sub>** starts up.

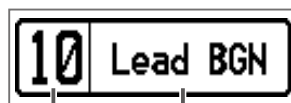

Patch number    Patch name

### ■ Switching patches

- Press .

This switches to the higher-numbered patch.

- Press .

This switches to the lower-numbered patch.

### ■ Switching banks

- Press  - .

The LED for the selected bank lights.

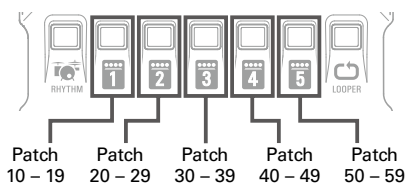

### Adjusting the overall audio character and output level

In MEMORY mode, turn <sup>1</sup>Lo - <sup>4</sup>Vol to adjust the overall audio character and output level of the **G1<sub>FOUR</sub>**/**G1X<sub>FOUR</sub>**.

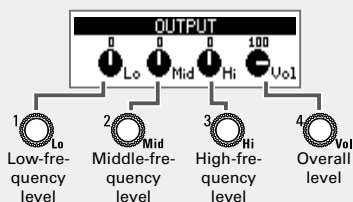

# Turning effects ON/OFF (STOMP mode)

In STOMP mode, you can use the footswitches to turn ON/OFF each of the effects used in the patch.

## 1. Activate STOMP mode.

- Press .

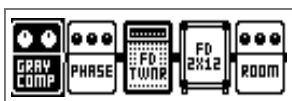

## 2. Select an effect.

- Press .

The selection moves to the right.



Selected

## 3. Turn the effect ON/OFF.

- Press .

This turns the selected effect ON/OFF.

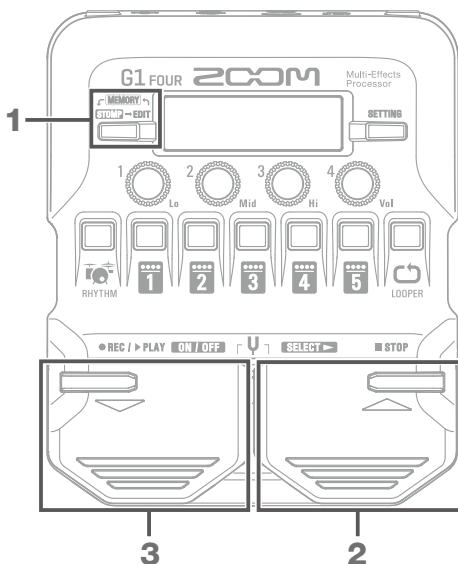
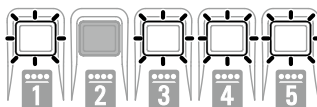
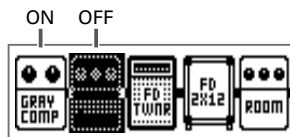

### HINT

You can also press the  -  that corresponds to an effect to turn it ON/OFF.

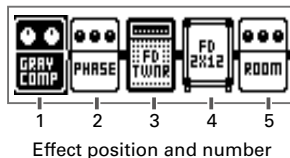

# Editing effects (EDIT mode)

In EDIT mode, you can change the effects used in a patch and adjust their parameters. Select a patch in MEMORY mode beforehand to edit it in EDIT mode.

## 1. Activate EDIT mode.

- Press .

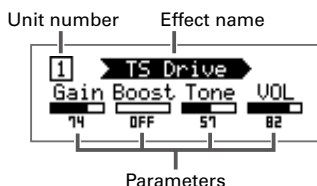

## 2. Select an effect to edit.

- Press - .

## 3. Turn the effect ON/OFF.

- Press the same - as in step 2 again.

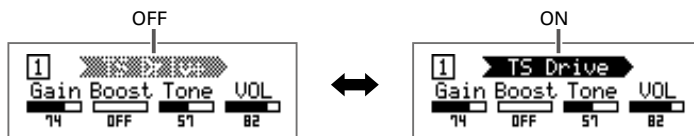

## 4. Adjust the effect parameters.

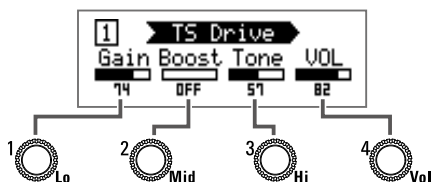

If an effect has 5 or more parameters, use to change the screen.

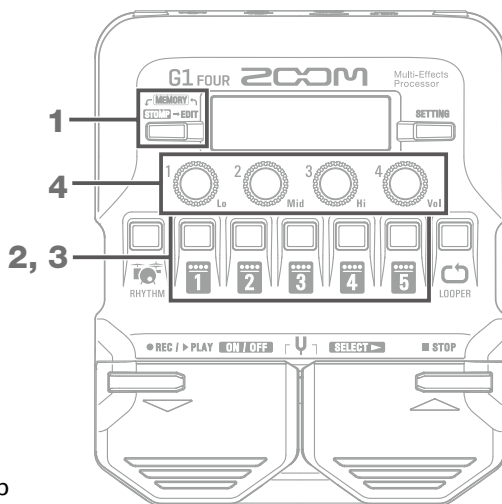

### NOTE

When the AUTO SAVE function is ON, changes to effects will be automatically saved. (→ P.10)

- **Effect**

Effects include all types of guitar effects and amp/cabinet simulation models.

- **Category**

Effects are grouped into categories by type. When selecting effects, you can switch by category.

### ■ Selecting effects

- Press .

This switches to the next effect.

- Press .

This switches to the previous effect.



#### HINT

See Guitar Lab for the explanations of each effect.

### ■ Selecting effect categories

- While pressing , press .

After the category name appears, the effect will change to the first effect in the category.



#### HINT

Select effects in the PEDAL category on the **G1X<sub>FOUR</sub>** to use effects that can be controlled by the expression pedal.

# Using the tuner

Use this to tune the connected guitar.

## 1. Activate the tuner.

- Press  and  at the same time.

To close the tuner, press  or

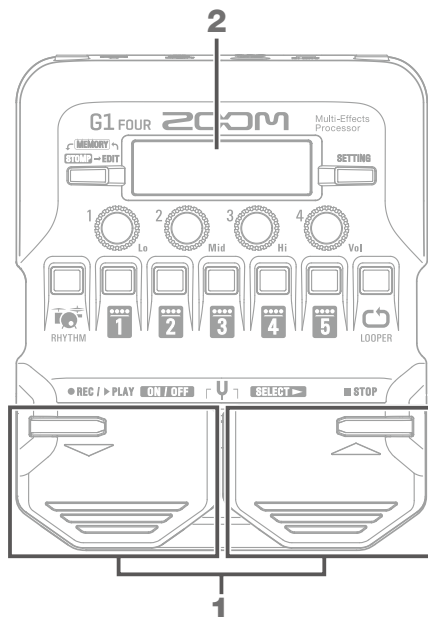

## 2. Tune the guitar.

- Play the open string that you want to tune and adjust its pitch.

The nearest note name/string number and pitch detuning will be shown on the screen and by the LEDs.

When the pitch is accurate, the LED at the center of the meter will light green and the LEDs to the left and right will light red.

Pitch detuning



Nearest note name/string number





← Flat

In tune

Sharp →

### Setting the tuner

- Turn  and  to set whether the guitar sound is output while tuning (BYPASS/MUTE) and the standard pitch.
- Press  to open the TUNER SETTING screen where you can set the tuner type and drop tunings.

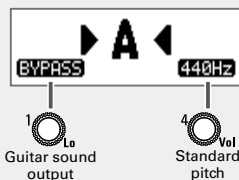

# Using rhythms

You can play along with built-in rhythms.

## 1. Activate the rhythm function.



To return to the previous mode, press



## 2. Start rhythm playback.



To stop rhythm playback, press 

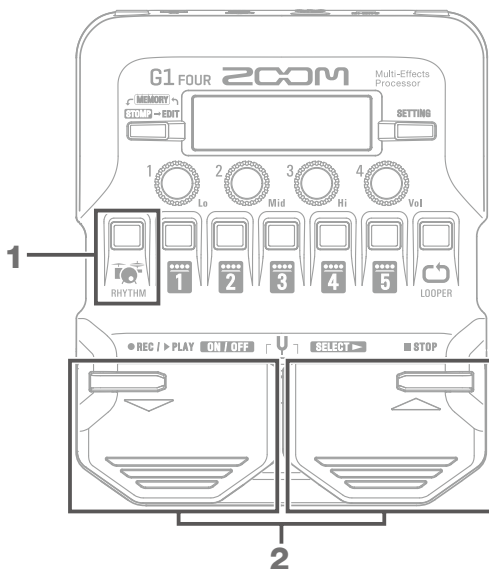

## Rhythm patterns



No.	Name	Time Sig.
1	GUIDE	4/4
2	8Beats1	4/4
3	8Beats2	4/4
4	8Beats3	4/4
5	16Beats1	4/4
6	16Beats2	4/4
7	16Beats3	4/4
8	Rock1	4/4
9	Rock2	4/4
10	Rock3	4/4
11	ROCKABLY	4/4
12	R'n'R	4/4
13	HardRock	4/4
14	HeavyMtl	4/4
15	MtlCore	4/4
16	Punk	4/4
17	FastPunk	4/4

No.	Name	Time Sig.
18	Emo	4/4
19	TomTomBt	4/4
20	Funk1	4/4
21	Funk2	4/4
22	FunkRock	4/4
23	JazzFunk	4/4
24	R&B1	4/4
25	R&B2	4/4
26	70s Soul	4/4
27	90s Soul	4/4
28	Motown	4/4
29	HipHop	4/4
30	Disco	4/4
31	Pop	4/4
32	PopRock	4/4
33	IndiePop	4/4
34	EuroPop	4/4

No.	Name	Time Sig.
35	NewWave	4/4
36	OneDrop	4/4
37	Steppers	4/4
38	Rockers	4/4
39	Ska	4/4
40	2nd Line	4/4
41	Country	4/4
42	Shuffle1	4/4
43	Shuffle2	4/4
44	Blues1	4/4
45	Blues2	4/4
46	Jazz1	4/4
47	Jazz2	4/4
48	Fusion	4/4
49	Swing1	4/4
50	Swing2	4/4
51	Bossa1	4/4

No.	Name	Time Sig.
52	Bossa2	4/4
53	Samba1	4/4
54	Samba2	4/4
55	Breaks1	4/4
56	Breaks2	4/4
57	Breaks3	4/4
58	12/8 Grv	12/8
59	Waltz	3/4
60	JzWaltz1	3/4
61	JzWaltz2	3/4
62	CtWaltz1	3/4
63	CtWaltz2	3/4
64	5/4 Grv	5/4
65	Metro3	3/4
66	Metro4	4/4
67	Metro5	5/4
68	Metro	

### Setting the rhythm

Turn  -  to change the rhythm settings.

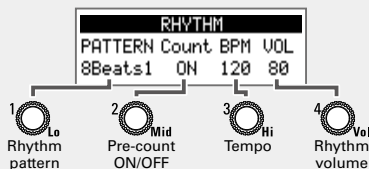







# Using the looper

You can record your playing and create mono loop phrases that are up to 30 seconds long.

## 1. Activate the looper.

- Press  .  
To return to the previous mode, press  .



## 2. Record a phrase.

- Press  .
- To stop recording, press  .
- To cancel, press  .

## 3. Play back the phrase.

- Press  .
- To stop playback, press  .

## 4. Overdub the loop.



- Press  during loop playback.
- To end overdubbing (and continue playback), press  .

### HINT

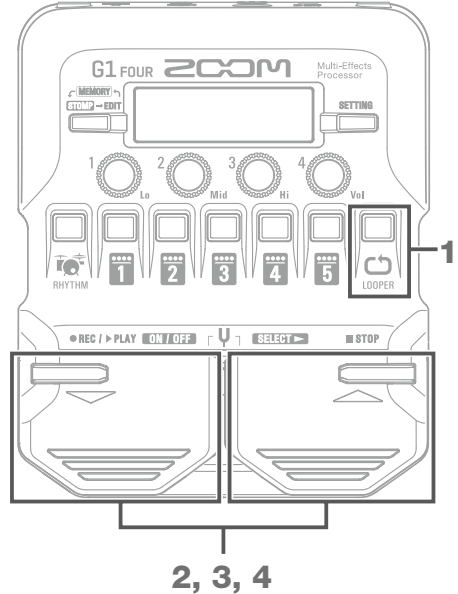
To clear the loop, you can press and hold  when loop playback is stopped.



## Setting the looper

- Turn  -  to change looper settings.
- Changing the recording time or tempo will clear any loop that has been recorded.

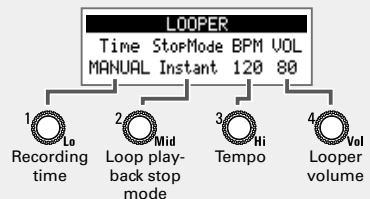

# Setting list

Press **SETTING**  to open the SETTING screen.

Press **1** – **5** to open the following settings, which correspond to the icons.

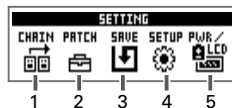





## 1. CHAIN (reorder effects)

Effects in the current patch are shown in a list, and can be reordered by pressing **1** – **5** for the starting location and destination.

## 2. PATCH (edit patch names and adjust volume)







Item	Explanation
CHAR	Change the character at the cursor position in the patch name.
◀ ▶	Move the cursor position in the patch name.
SKIP	Change the type of character at the cursor position in the patch name.
VALUE	Adjust the patch volume.

## 3. SAVE (save and swap patches)

To save a patch by overwriting another patch, use ,  and **1** – **5** to select the patch number. Then, press  and  at the same time.

To swap a patch, turn  to select SWAP when conducting the procedure above.

## 4. SETUP (set operation functions)

Item	Explanation
BPM	Set the tempo used for the effects, rhythms and looper.
AUTO SAVE	This function can automatically save effect parameter changes when they are made. When OFF, a save confirmation screen will open whenever you switch patches.
PRESELECT	Use this function to select a non-adjacent patch and switch to it directly. Use  and  to select the patch, and press   at the same time.
BANK HOLD	Limit to patches in the same bank when using  and  to switch patches.

## 5. PWR/LCD (make power and the display settings)

Item	Explanation
BATTERY	Set the type of battery used so the amount of remaining battery charge can be accurately shown.
ECO	The power can automatically turn off if no use occurs for 10 hours.
BACKLIGHT	Set how long the display backlight stays illuminated.
CONTRAST	Adjust the display contrast.

### HINT

See the Operation Manual for detailed information about each setting.

# Specifications

Maximum number of simultaneous effects	5	
User patches	50	
Sampling frequency	44.1 kHz	
A/D conversion	24-bit 128 × oversampling	
D/A conversion	24-bit 128 × oversampling	
Signal processing	32-bit	
Display	128 × 32 dot-matrix LCD	
Inputs	INPUT	Standard mono phone jack Rated input level: -20 dBu Input impedance (line): 470 kΩ
	AUX IN	Stereo mini jack Rated input level: -10 dBu Input impedance (line): 1 kΩ
Output	OUTPUT	Standard stereo phone jack (combined line/headphone) Maximum output level: Line +2 dBu (10 kΩ or more output impedance) Headphones 17 mW + 17 mW (32 Ω load)
Input S/N	120 dB	
Noise floor (residual noise)	-97 dBu	
Power	AC adapter (9 V DC 500 mA, center negative) (ZOOM AD-16) 4 AA batteries (about 18 hours continuous operation time when using alkaline batteries with the LCD backlight off)	
USB	USB MIDI, USB Micro-B • Power can also be supplied through the USB port. • When using a cable designed only for power, other USB functions cannot be used.	
External dimensions	<b>G1</b> FOUR	156 mm (D) × 130 mm (W) × 42 mm (H)
	<b>G1X</b> FOUR	156 mm (D) × 216 mm (W) × 52 mm (H)
Weight	<b>G1</b> FOUR	340 g (excluding batteries)
	<b>G1X</b> FOUR	610 g (excluding batteries)

Note: 0 dBu = 0.775 V



**ZOOM CORPORATION**

4-4-3 Kanda-surugadai, Chiyoda-ku, Tokyo 101-0062 Japan

[www.zoom.co.jp](http://www.zoom.co.jp)