

THE UNIDYNE® STORY

1939

2014

OUR LEGENDARY MICROPHONE THAT NEEDS NO NAME

SHURE®

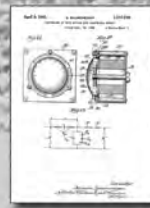

When I came to Shure Brothers, Incorporated (the Company name at that time), on January 31, 1949, the Unidyne Microphone, Model 55, had been introduced about ten years earlier. I recall being impressed with the elegant design of the Unidyne the first time I saw it. Somehow, the Unidyne seemed to be a perfect version of what a microphone should look like.

As I became more familiar with my co-workers and how the Company operated, the Unidyne came to symbolize product qualities for appearance as well as performance.

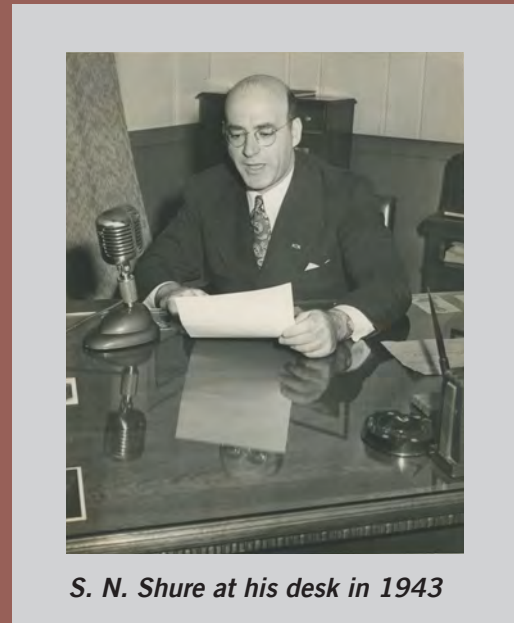

S. N. Shure at his desk in 1943

Over time, I saw the Unidyne being used by notable public figures, celebrities, and popular entertainers in films and theaters, at significant functions and events, and more.

I am thrilled that our Unidyne Microphone has received the prestigious IEEE Milestone Award in recognition of its 75th Anniversary year.

- Rose L. Shure

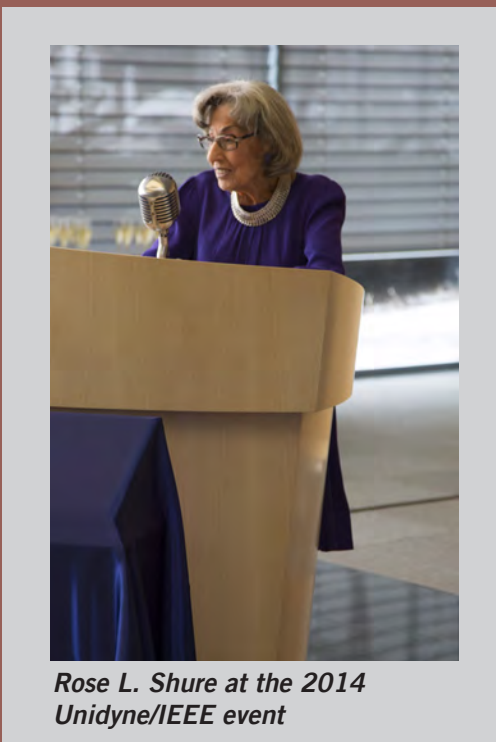

Rose L. Shure at the 2014 Unidyne/IEEE event

INTRODUCTION

At any given moment, people in all parts of the globe rely on Shure products to communicate, entertain, and educate. The Shure® brand is known and trusted worldwide by audio professionals and enthusiasts alike.

Our founder, Sidney N. Shure, established the Company around a set of ethical business principles. Shure Incorporated has been in continuous operation since 1925, a testament to the soundness of these principles. Mr. Shure's values and philosophy continue to guide Shure Associates today, and are reflected in the products and services provided to our customers.



Shure offers audio products ranging from wired microphones and wireless microphone systems to mixers, conferencing systems, and listening products.

Shure products are critical components in touring sound, broadcast, installed sound, conferencing, and studio recording applications, to name a few.

Throughout most of our history, one microphone series has remained in our catalog longer than any other – the Unidyne. Widely recognized the world over, it is synonymous with the name Shure.

In presenting this rich and fascinating history of the Unidyne Series, Shure thanks our Associates and customers who have faithfully stood with us over the years. Our commitment to providing quality products remains the same now as when the first 55 Unidyne Series made its debut in 1939.

Sleek in design with a futuristic look, the 55 Unidyne Series came to symbolize the word “microphone.” Following its debut in the 1939 catalog, the 55 Unidyne Series embarked on a decades-long path that brought professional and public recognition rarely attained by any product.

The visibility of the Unidyne Microphone and the indelible marks it etched on the world’s collective psyche are not the result of coincidence. Its benchmark status was earned through a reputation as a tireless workhorse and dependable performer, achieved by unprecedented audio quality and reliability.

The 55 Unidyne Series quickly became a mainstay in the world of professional audio. Celebrities, entertainers, and politicians relied on them. They survived war-time service and were familiar fixtures at critical moments in history. Scores of photographs, films, and videos show this microphone series in the company of kings, queens, presidents, and generals. They stood in front of Frank Sinatra and Ella Fitzgerald during the Big Band era. Elvis embraced them in performance and on a first-class stamp issued in 1994 by the United States Postal Service. Countless rock stars, past and present, have chosen the 55 Unidyne Series. Today, decades after their first appearance, Unidyne Microphones are as popular and sought after as ever. While the microphones have been improved over the years to keep them technologically up-to-date, they still retain the streamlined appearance of the 1930s.



HISTORICAL ORIGIN

In 1939, the original Unidyne became the first in the 55 Series. Using the proprietary Shure "Uniphase" acoustical system, the Unidyne was marketed for broadcast, public address, recording, and two-way radio. It was sold in three configurations, each with a different impedance option. The Model 55A was low impedance for broadcast applications; the Model 55B was medium impedance for public address and recording applications; and the Model 55C was high impedance for two-way radio applications. List price in 1939 for the 55A was \$42.50 (U.S.), while models 55B and 55C cost \$45. Catalog copy proclaimed that "you get the sound you want, as you want it." It was, "the first high-quality, low-cost moving-coil dynamic microphone with true cardioid unidirectional characteristics." The Unidyne reduced the problems of feedback, background noise, and reverberation.

Shure literature touted the advantages of cardioid unidirectional microphones, which "give wide angle coverage with excellent high-quality response at the front, yet are dead at the rear." Even today, a Unidyne Microphone is often the first choice in difficult acoustical situations.

Shure engineer Benjamin Bauer was the driving force behind the development of the first Unidyne. Bauer began developing the microphone in early 1937. In undertaking the project, his primary objective was to create a unidirectional microphone using a single dynamic element. Before the Unidyne, the most common way of creating a microphone with a cardioid response was to use an omnidirectional (non-directional) element, combined with a bidirectional ("figure-eight" pickup pattern) element in a single housing. When the outputs from both cartridges were electronically combined, the result was a cardioid pickup pattern. Other directional patterns could be obtained by altering the relative balance of the two cartridges with a multi-position switch.

Further work on unidirectional dynamic microphone 7/7/38.

The "unidirectional" action depends upon the relation

$$-P/Q = E'_{180}/E'_{180}$$

If it is assumed that for frequencies at which the front-to-back distance is less than 1/4 wavelength of sound, E and E' are equal and displaced by an angle $\theta = d/C_v$, then the fraction P/Q will be a unit vector at an angle indicated by the expression for θ .

It has been shown that in the equivalent circuit of the "uni" dynamic microphone

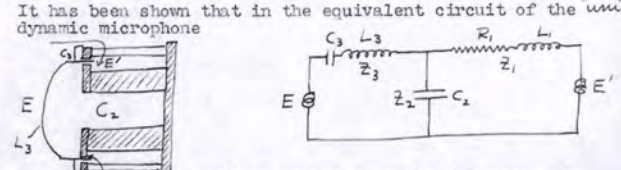

$-P/Q$ essentially equals the expression $1 - j\omega LC_2 + j\omega RC_2$, and that this expression is very nearly a unit vector at an angle θ if $RC_2 = d/C_v$ and if $LC_2 = d^2/2C_v^2$. It has been shown also that if a slit is used the thickness of the slit is given by the expression $.0047 V d$. Assuming that the distance d is 1" (2.54) cm, the thickness of the clearance between the pole shoe and the coil would be approx. .0075 cm (.003"). The practical limitations in the loudspeaker field are more severe than those in the microphone field because of the larger axial excursion of the coil required, however .006" clearances are not uncommon. It seemed that a .005" clearance would not be excessively small, however there would be tremendous practical difficulties in attempting to obtain a .003" clearance.

In a microphone with a front-to-back distance d equal to 2.5 cm and a total internal volume of 6 cc, $C_2 = 4.25 \times 10^{-6}$ and ~~and~~ a resistance of the slit R of 17.3 ohms and an inductance L of .000621 gm/cm² is required. A slit .159 cm long (1/16") .0127 cm thick (.005") and 10 cm wide will have the required resistance, however the inductance will be .0015 gm/cm² instead of .000621. The resulting effect is that the expression $1 - j\omega LC_2 + j\omega RC_2$ will no longer represent the vector condition desired at frequencies above several hundred cycles (as will be shown later). Thus the directional discrimination would be impaired at higher frequencies. In addition the frequency response would suffer. A typical frequency response of such a unit is shown below:

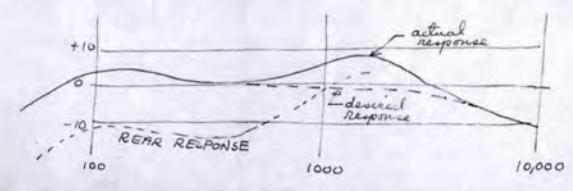

**Technical explanation of the Unidyne Microphone
authored by Ben Bauer in 1938**

These early dual element unidirectional microphones had drawbacks. Their size tended to be large and bulky, and consistent performance was challenging to maintain. As the omnidirectional and bidirectional elements did not possess the same frequency responses, and occupied different locations within the housing, the resultant frequency response and polar pattern were irregular and difficult to control.

Ben Bauer recognized that the best way to address these difficulties was to use a single element. He began by examining the underlying physics. He understood that if a single element was exposed to sound only on its front side, the result was an omnidirectional pattern. A bidirectional microphone would result if both sides – the front and back – were exposed to sound. With those two concepts in mind, Bauer realized that if he could partially block the back side of a microphone element, in theory he would achieve a response between an omnidirectional and a bidirectional, which would be cardioid (heart-shaped). His research led to the Uniphase acoustical system, which was used in Shure's first single element microphone, the Uniphase, and later in the Unidyne.

Bauer's Unidyne was configured with an acoustical network of front and rear openings that en-

abled sound waves to reach both sides of the microphone's diaphragm. The sound waves reaching the diaphragm from the rear had a longer path and passed through openings that produced a time delay between the sound entering from the rear and sound waves striking the front of the diaphragm. By varying the acoustical resistance in the rear openings, Bauer was able to achieve a cardioid, a supercardioid, or a hypercardioid pattern using a single element, and the first unidirectional dynamic microphone became reality.



THE MICROPHONE THAT NEEDS NO NAME

An instant success, the original Unidyne set a new standard of high quality audio combined with discrimination against unwanted sounds. True to Bauer's design, the directional response was more predictable and better behaved than its predecessors, so it offered a new ability to control feedback and reduce ambient noise pickup. In addition, its size was small compared to competitive offerings, making it popular with singers, entertainers, and public speakers.

During the years between 1939 and 1946, the Unidyne changed very little. Variations of the original design included the 1940 introduction of a separate broadcast version (Model 555), which had an improved vibrational isolation mount. A radio station call letter plate that fit on the top of the microphone was sold separately as an accessory.

By 1947, the broadcast version had become Model 556, and the three 55 models with different impedances were replaced with one single model, equipped with a multi-impedance selector switch located under the case at the rear. Changes were in the offing at the end of the decade; however, as Shure prepared to deliver yet another breakthrough.

In the 1950s, Shure created a print ad for trade publications that illustrated the industry dominance that the Unidyne held around the globe. It was titled "Photographed With More Celebrities the World Over...Than Any Other Microphone." The subhead read "The Microphone That Needs No Name." The ad featured a large photo of the Unidyne, but neither the name nor model of the microphone appeared at all. The objective of this ad was to demonstrate how popular the Unidyne had become. It was a microphone that needed no name or introduction. It was recognized everywhere.

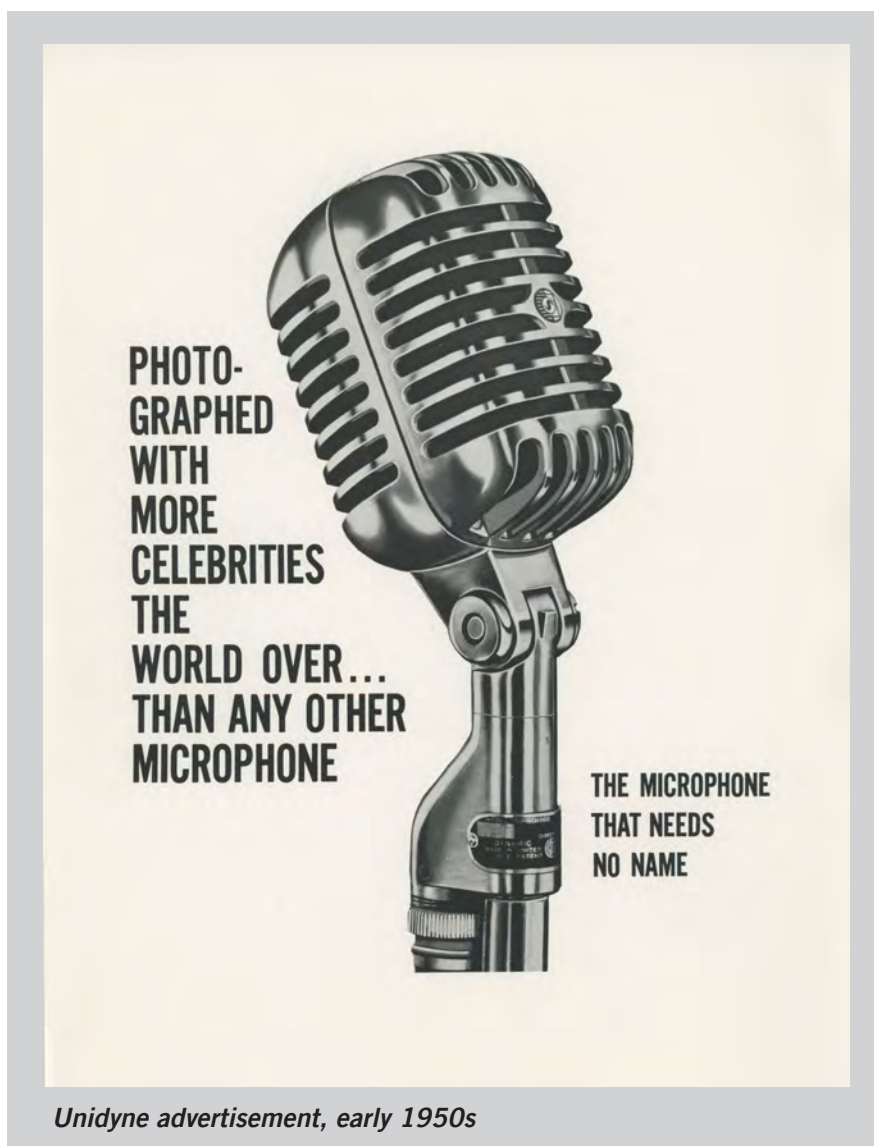

THE MICROPHONE THAT NEEDS NO NAME

At the same time the print ad appeared, Shure finalized the elements of the next Unidyne generation. Unveiled in 1951, the new “Small Unidyne” featuring the Unidyne II cartridge improved on the features that made the original Unidyne such a success. As their name implies, the Small Unidynes were lighter in weight and more compact than the originals.

Compared to their predecessors (which were still offered in 1951), the Small Unidynes were only about two-thirds the size and available in two model configurations—Model 556S (for broadcast) and Model 55S (for general purpose). The new cartridge improved performance with the addition of improved magnet materials, diaphragm suspension, and cartridge isolation. Unwanted noise pickup was reduced even further, while frequency response was refined as well. Like the Standard Unidynes, the Small Unidynes were equipped with a multi-impedance selector switch.

The new Unidyne cartridge brought more success to Shure. It was employed until 1989, when it was replaced by an updated cartridge.

Other modifications to the 55S included a change to the support base in 1961, the elimination of the multi-impedance selector in 1978, and the use of open cell foam as the internal windscreen material replacing the original open weave cloth.



Teaser postcards for the introduction of the 55S, April 1951

THE STATUS OF AN ICON

What is so special about the 55 Unidyne Series Microphones, and why do they remain so popular? “Part of the answer lies in that they have become cultural icons,” answers Shure Associate Tim Vear. “Technically speaking, they also had the luck of falling into a design category that proved to be the one that won out over everything else. Driven by the popularity of the Unidyne Series, carbon and crystal microphones gradually fell by the wayside, but dynamic microphones live on.”

A keeper of Corporate folklore, Vear is an expert on 55 Unidyne Series facts, philosophy, and trivia. “With the exception of some reissues of old Neumann condenser microphones, I don’t think there is any other microphone currently in production that goes back as far as the 55,” he states. “The reality of having been around for generations has helped make these products iconic, both internally at Shure and to the rest of the world. If you look around our offices, you’ll find 55 Series pins, engravings, posters, etched paperweights, and bookends. The image has even served as a watermark on invoices. When people in our industry see a 55 Series Microphone, they can’t help but think of Shure. Conversely, when someone outside the industry sees one, it serves as a visual cue that can help transport them to a different era. Something I refer to as a ‘coolness quotient’ also adds to the iconic status of the 55 Series. Viewed from a design perspective, they exude all of the coolness of a ‘57 T-bird, Stratocaster guitar, or a James Dean movie. They are, however, much more than a symbol. They are real microphones that adhere to the Shure tradition of excellence in performance and quality.”



Promotional and commemorative Unidyne items

If the performance of the 55 Series, from the original Unidyne to the Model 55SH Series II to the Super 55 and beyond, is any indication, the line is ready to confront the audio challenges of the future. All 55 Unidyne Series Microphones will still serve a variety of sound reinforcement needs, and will be used in films and television to add realism to scenes depicting events from the past. Will they still be cool in 2025, at Shure's 100th anniversary? Just look into the polished luster of the ribbed housing. The answer is right there.



5575 Limited Edition to be released in 2014

1939



55A - \$42.50; cardioid; low impedance (50 ohms)
55B - \$45; cardioid; medium impedance (250 ohms)
55C - \$45; cardioid; high impedance (15,000 ohms)

1940



555A - \$60; cardioid; low impedance (50 ohms); shock mount in lower portion of mic
555B - \$60; cardioid; medium impedance (250 ohms); shock mount in lower portion of mic
555C - \$60; cardioid; high impedance (15,000 ohms); shock mount in lower portion of mic

1942



55AV - \$46; cardioid, low impedance (50 ohms); increased high frequency response for voice clarity in paging and two-way radio systems
55BV - \$48; cardioid, medium impedance (250 ohms); increased high frequency response for voice clarity in paging and two-way radio systems
55CV - \$48; cardioid, high impedance (15,000 ohms); increased high frequency response for voice clarity in paging and two-way radio systems
556A - \$75; supercardioid; low impedance (50 ohms); shock mount in lower portion of mic
556B - \$75; supercardioid; medium impedance (250 ohms); shock mount in lower portion of mic
556C - \$75; supercardioid; high impedance (15,000 ohms); shock mount in lower portion of mic

1947



55 - \$55; cardioid; add impedance switch (low-medium-high)
556 - \$85; supercardioid; add impedance switch (low-medium-high)

1951



55S - \$72; cardioid; add impedance switch (low-medium-high); "S" designation meant "Small"
556S - \$100; supercardioid; add Cannon XL connector; add impedance switch (low-medium-high); shock mount in lower portion of the mic

1961



55SW - \$85; cardioid; add on/off switch; "W" designation meant "sWitch"

1967

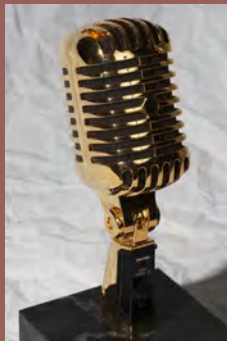

55S Gold - \$93; cardioid; gold plated 55S
55SW Gold - \$95; cardioid; gold plated 55SW

1970

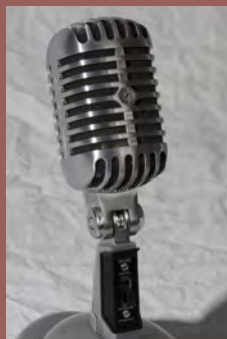

PE55 - \$75; cardioid; factory set to high impedance; eliminate impedance switch; add plastic carrying case and cable

UNIDYNE TIMELINE

1978



PE55SH - \$112; replace Amphenol connector with XLR connector
55SH - \$100; cardioid; replace Amphenol connector with XLR connector; eliminate impedance switch; internal high-low impedance choice on XLR connector

1989



55SH Series II - \$189; cardioid; low impedance only; new mic element

2009



Super 55 - \$311; chrome case with blue foam; supercardioid; improved frequency response; low impedance only; no switch

2010



Super 55-BCR - \$354; black case with red foam; limited production run; supercardioid; improved frequency response; low impedance only; no switch

The 55 Series has led an exciting life. It helped to define different eras, and it enjoyed front row seating at noteworthy events of all description. Some highlights from its illustrious history include:

When crooner Rudy Vallee scrapped his quaint, but old-world megaphone and switched to a Unidyne, he became the first prominent entertainer to adopt the technology for live performances.

General Douglas MacArthur used Shure Unidynes on the deck of the U.S.S. Missouri during ceremonies ending the war with Japan in 1945.

The Unidyne is obvious in the famous photo of President Harry S. Truman holding up the erroneous newspaper headline reading “Dewey Defeats Truman.”



Shure employees discuss Unidyne assembly details, June 1943

Photos of Eva Peron delivering speeches clearly demonstrate her microphone of choice. True to history, the Unidyne also made it into “Evita,” the Broadway hit musical based on her life.

The film “Good Morning, Vietnam,” starring Robin Williams, made the Unidyne its virtual co-star. The microphone was also seen in print ads and posters for the film across the U.S.

In 1994, the U.S. Postal Service issued stamps that prominently featured the Unidyne. One was the 29-cent Elvis stamp.

The list of major entertainers who used or are still using Unidynes would probably fill two volumes. Just a few of the names from the list include Marlene Dietrich, Dean Martin, Jerry Lewis, Tony Bennett, Buddy Guy, Tom Petty, LeAnn Rimes, Metallica, and Mariah Carey.

IEEE MILESTONE AWARD

In 2014, the Shure Unidyne was awarded the prestigious Milestone Award from the Institute of Electrical and Electronics Engineers.



Here is Shure's submission to the IEEE Committee, written by Shure Historian Michael Pettersen.

What is the historical significance of the work (its technological, scientific, or social importance)?

The year 2013 marks the 75th anniversary of Ben Bauer's invention of the Uniphase principle while working for Shure Brothers Incorporated, a microphone manufacturer in Chicago. As a newly-graduated engineer, the 25 year-old Bauer developed an acoustical method that produced a directional microphone using only one microphone element. The Uniphase principle paved the way for the design of the Shure Unidyne Microphone. Introduced in 1939, the Shure Unidyne is arguably the most recognized microphone in the world.

Benjamin Bauer (originally Baumzweiger) was born in Odessa, Russia, in 1913. His family fled Russia after the 1917 revolution and relocated to Havana, Cuba. At the age of 17, and speaking little English, Bauer moved to New York City to attend the Pratt Institute. After obtaining an Associate Industrial Engineering degree, Bauer matriculated at the University of Cincinnati, pursuing an Electrical Engineering degree. Bauer chose a five-year work/study program and began working as an intern at Shure. When he graduated in 1937, he joined Shure full time as a transducer development engineer. It was the start of a distinguished career in acoustics and audio that included more than 100 patents.

Three technologies came of age during the 1930s, and a nascent technology was being nurtured. Radio broadcasting, public address systems, and two-way radio communication became commonplace in the 1930s, and television broadcasting was in development. One common factor required for all was the use of a microphone.

A microphone is a transducer. The function of a transducer is to change one type of energy into another type. A microphone changes acoustical energy (sound waves) into analogous electrical energy. After the sound waves become electrical waves, they can be amplified, broadcast, stored on disc, wire, and magnetic tape, or manipulated in other ways. A microphone was the primary audio signal source for radio, public address, and television. Since the 1930s, a microphone has been present at nearly every major event that has shaped the world.

In the early 1930s, the carbon element microphone was in common use. Though not expensive, its audio quality was poor; it required a DC power source to operate; it had no ability to reject unwanted background noise. There were also condenser element microphones – expensive and fragile, and crystal element microphones – adversely affected by heat and humidity.

In 1939, Shure began to manufacture microphones with dynamic elements. This dynamic element microphone was, in essence, a loudspeaker in reverse. Instead of a paper cone, there was a circular, aluminum diaphragm. Glued to the diaphragm was a voice coil wound from miniature wire. The voice coil was positioned in the middle of a miniature permanent magnet. Sound waves from the talker moved the diaphragm (suspended like a trampoline), which, in turn, moved the voice coil. A tiny voltage was induced in the voice coil because of the magnetic field. This voltage was the electrical equivalent of the sound wave.

Precision manufacturing techniques were necessary to create a dynamic microphone element, but the underlying design was simple. The result was a reliable, rugged microphone that was inexpensive, required no external power, and could be made by the thousands with repeatable tolerances. Yet the dynamic element microphone did not solve the problem of unwanted background noise.

Unwanted background noise (ambient noise) is often a problem wherever a microphone is used. In a radio studio, the background noise might originate with the audience whispering or turning program pages. These noises would be distracting to the radio listener at home. In two-way radio communications (fire, police, medical), unwanted background noise would reduce the intelligibility of the messages being sent and could result in loss of life. In public address systems, unwanted background noise can be the root cause of acoustic feedback - that annoying squealing and howling that occurs when a public address system is turned up too loud. The unwanted background noise is the amplified sound waves emanating from the loudspeakers. When the loudspeaker sound waves are picked up by the microphone, the waves are re-amplified again and again, and a “feedback” loop is created.

A directional microphone is a necessary tool to reduce the pickup of unwanted background

noise. It is more sensitive to sound waves that originate at the front; less sensitive to sounds that originate to the sides; and far less sensitive to sounds that originate to the rear. The most common and useful microphone directional pattern is shaped like a heart and aptly named “cardioid,” as in cardiac. Be it a radio studio, a police station, or an auditorium, a directional microphone will reduce unwanted background noise and that will improve the quality of the audio signal being heard by listeners. The Shure Unidyne was the world’s first directional, dynamic, single element cardioid microphone. Manufacturing of the Unidyne began in 1939, and it has been in production ever since.

The industrial design of the Unidyne is firmly grounded in the Art Deco movement. Sleek in design with a futuristic appearance, the Unidyne pays homage to the grilles of late 1930s automobiles, such as the 1937 Oldsmobile Six convertible coupe. The appearance of the Unidyne has come to mean “microphone” worldwide. A Google™ image search on “microphone” presents the Unidyne as the first result. The Unidyne has appeared on postage stamps in many countries. It has been a graphic icon on countless television

shows and innumerable websites. It has public recognition rarely attained by any product except perhaps the Coca-Cola™ bottle. The reason is that the Unidyne has been in front of celebrities, politicians, and entertainers for more than seven decades...and has been photographed with these people during celebrations, performances, and historical events. Examples include: Martin Luther King, Jr.’s “I Have A Dream” speech, “Dewey Defeats Truman” *Chicago Tribune* headline, Elvis Presley performing, President Franklin D. Roosevelt addressing the nation during World War II, Frank Sinatra during the Big Band era, Indira Gandhi giving a political address, the Japanese surrender on the battleship Missouri, Groucho Marx radio programs, “Star Wars” movies, “Battlestar Galactica” TV series, President Kennedy press conferences, and singer Taylor Swift at the GRAMMY® Awards.

It is not hyperbole to state that since 1939 a Shure Unidyne has been the chosen microphone model at more important historical and entertainment events than any other microphone.

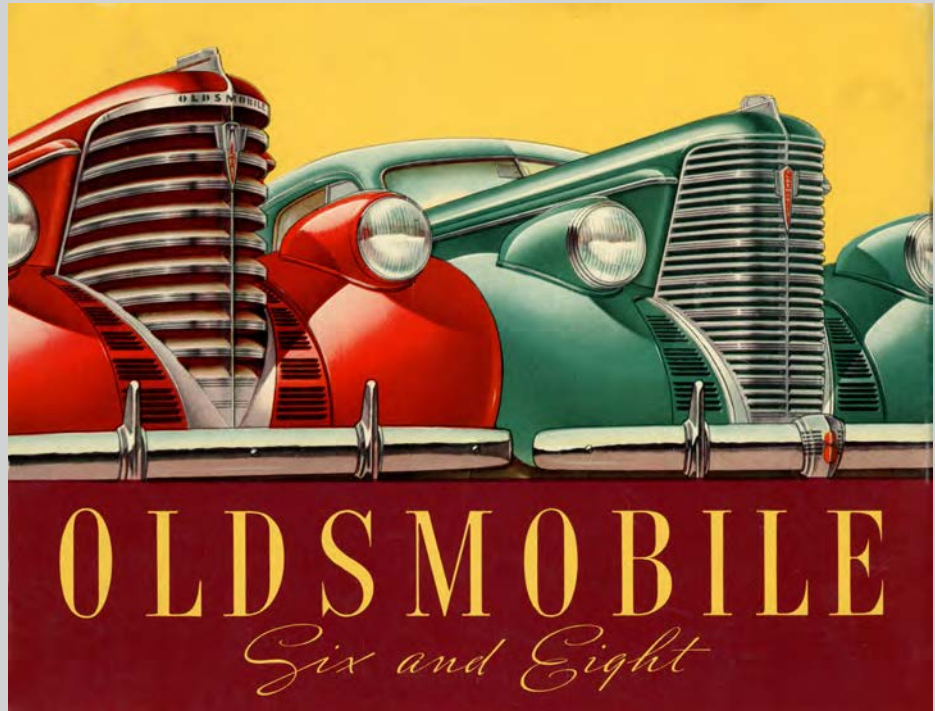

1937 Oldsmobile catalog cover

What obstacles (technical, political, geographic) needed to be overcome?

Before the Unidyne, the prime method of creating a microphone with a directional response used an omnidirectional element combined with a bidirectional element. Both elements were fixed into a single microphone housing. By electrically combining the two signals from the two elements, a variety of directional patterns could be obtained.

These dual element directional microphones had many drawbacks. First, they were large, heavy, and bulky. Second, they were expensive to manufacture, as each microphone required two elements and a signal mixing circuit. Third, the two elements did not possess the same frequency response and could not occupy the same physical space, so the resultant directional pattern was irregular and difficult to control, as was the frequency response. This meant performance inconsistency and wide tolerances in the manufactured products.

Ben Bauer inherently understood that the best way to deal with these drawbacks was to develop a directional microphone that required only one mic element. He began by examining the underlying physics of a microphone and sound waves. Bauer knew that when a mic element was exposed to sound only on its front side, an omnidirectional pattern was obtained. In contrast, a bidirectional “figure eight” pattern was created when both sides, front and back, were exposed to sound. With these facts in mind, Bauer calculated that if he could partially block the back side of a microphone element, he would create a directional pattern somewhere between omnidirectional and bidirectional.

Eventually, Bauer designed an element with precision openings at the front and at the back of the element. Sound waves that entered the rear openings passed through acoustical material that delayed the waves in relation to the sound waves entering at the front. By varying the amount of acoustic delay, it was feasible to create different directional patterns using only a single element. This principle was dubbed Uniphase and led to the development of the single element crystal microphone, the Uniplex, and the single element dynamic microphone, the Unidyne.

Crystal microphone elements were inherently unreliable due to the effects of heat, humidity, and physical shock. In contrast, dynamic microphone elements were virtually unaffected. Natural selection dictated the success of the

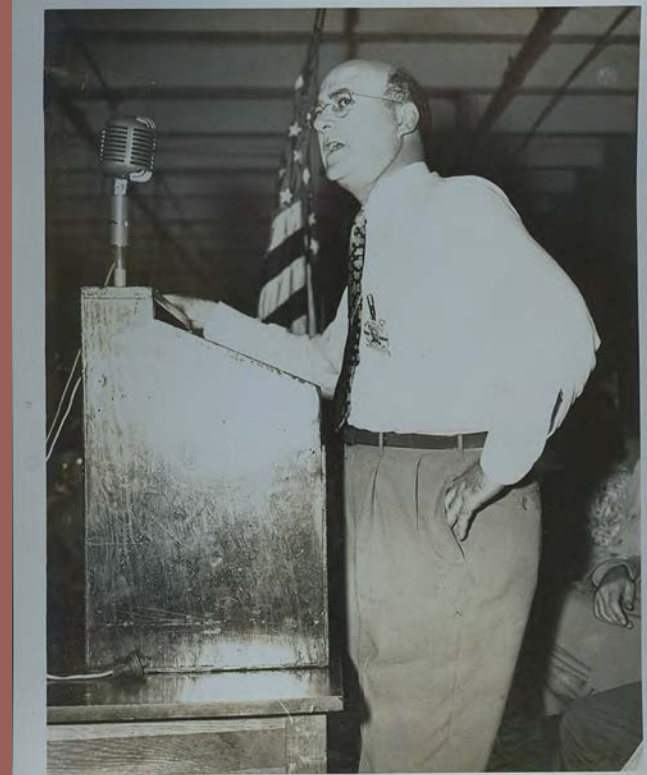

S.N. Shure addresses employees at the Chicago manufacturing plant in 1943

IEEE MILESTONE AWARD

Unidyne and the rapid extinction of the Uniplex. The Unidyne design has proven so reliable that Unidyne Microphones from the 1940s are still in operation, and Unidyne Microphones are still being manufactured today.

The nomenclature “Unidyne” can be interpreted in multiple ways: Uni = one mic element; Uni = “uni”directional pattern; Uni = unique. Dyne = dynamic mic element; Dyne = unit of force used in acoustical measurement. S. N. Shure, the founder of Shure Incorporated, was a lifelong student of language and often chose trademarks that had multiple meanings.

What features set this work apart from similar achievements?

The Unidyne Microphone was the first directional microphone that used a single dynamic mic element. Using a single element reduced the size, weight, and manufactured cost; increased reliability; and significantly improved acoustical performance. The Unidyne spawned even more popular models. The Unidyne II, a smaller version of the Unidyne, was introduced in 1951. The Unidyne III, grandchild of the Unidyne, was introduced in 1959. It is the most widely used professional microphone in the world and has been the microphone of choice for every U.S. President since Lyndon Johnson. And, in 2014, a Unidyne III Microphone is in use on the International Space Station for live TV and Internet interviews with the crew.



BENJAMIN BAUMZWEIGER BAUER (1913-1979)

Inventor of the Unidyne Microphone

Ben Bauer was born Benjamin Baumzweiger on June 26, 1913, in Odessa, Russia. His family fled to Poland when he was eight to escape anti-Semitism, only to find the same attitudes in Poland. The family then immigrated to Havana, Cuba, when he was a teenager. In the 1920s, there was a large Jewish community in Cuba that moved from Europe. After graduating from high school and speaking little English, Bauer moved to New York City in 1930 to attend the Pratt Institute. In 1932, he received a degree in Industrial Engineering. He then pursued an Electrical Engineering degree at the University of Cincinnati. Fortunately, Shure Brothers Incorporated of Chicago, Illinois, was offering a work co-op program, and Bauer took advantage of this program by alternately working for Shure and attending school.

When Bauer graduated in 1937, he was hired by Shure as a full-time acoustical engineer. His first significant contribution was the development of the first unidirectional (cardioid) microphone that employed a single transducer. Using the patented Uniphase acoustical system developed by Bauer, Shure introduced the Uniphase Crystal Microphone, Model 730A, and the now-legendary Unidyne Dynamic Microphone, Model 55, in 1939.

In 1941, Bauer became a citizen of the United States and changed his last name from Baumzweiger to Bauer. His contributions at Shure included disc-cutter designs, phonograph pickups, and the moving-coil pistonphone used for microphone calibration work. During World War II, he worked on the development of speech communication equipment for the Armed Services. One such device was the battle-announce microphone used during and after the war by the U.S. Navy, and the throat microphones that were widely employed in fighter and bomber aircraft. After World War II, Bauer became Vice President of Engineering at Shure Brothers Incorporated.

In 1957, Bauer left Shure to join CBS Laboratories in Stamford, Connecticut, as the head of audio technology development. At CBS, he led a select group of engineers who focused on stereo LP discs, magnetic recording, and other equipment to improve the quality of recorded music. One of his research efforts resulted in the development of a loudness-level indicator, a device used by the Federal Communications Commission and others in monitoring broadcast programs.

In 1970, his team developed the SQ-quadrasonic matrix system, which, in 1977, was judged by the Federal Communications Commission Laboratory to be the best of all matrix systems tested. Bauer was made Vice President and General Manager of the CBS Technology Center at Stamford in 1975, where he directed research and development in areas of advanced television, high-density recording, audio systems, and audio reproduction.

In addition to his work in airborne sound, Bauer made key contributions to the field of underwater sound, including underwater directional communication systems for divers, directional gradient hydrophones for Navy sonobuoys, and a hydrophone calibrator. Upon his death in 1979, his name appeared on more than 100 patents that included the fields of microphones and transducers, sound transmission, audio processing for recording and broadcasting, acoustic measurements and calibration, sound recording and reproduction, and quadrasonic disc technology.

SNS

UNIVERSITY OF CINCINNATI
COLLEGE OF ENGINEERING AND COMMERCE

Cincinnati, Ohio,
December 24, 1935.

Mr. Ralph P. Glover,
Chief Engineer,
Shure Brothers Company,
Microphone Headquarters,
215 West Huron St.,
Chicago, Illinois.

Dear Mr. Glover:

Since my return to Cincinnati, I have consulted with the electrical department regarding a co-operative student for your organization. We have all decided on one of our Junior students as having the qualifications required for your work. This man's name is Benjamin Baumzweiger. He has made an excellent record at the university, in fact he is heading his class. His outside work record is excellent. He is a very good mechanic, is a good electrical testing instrument maker, and is very much interested in radio work. We can all recommend him to you very highly for your job.

We thought that the rate of pay for him should be about twelve dollars a week.

If you can use him, I will make the arrangement for him to report to you at your convenience.

I thank you for your co-operation.

Very truly yours,



G. T. Addison,
Associate Professor,
Dept. of Co-ordination.

University of Cincinnati recommends Benjamin Baumzweiger as a co-op student. Ralph Glover, Shure Chief Engineer, was a graduate of the University of Cincinnati

1/2/36

December 28, 1935

Associate Professor G. T. Addison
Department of Co-ordination
College of Engineering and Commerce
University of Cincinnati
Cincinnati, Ohio

Dear Professor Addison:

Thank you very much for your letter of December 24, regarding Mr. Benjamin Baumzweiger. Mr. Shure has requested that I obtain a complete personal record on this man, of much the same character as would be furnished us if he were applying for a job in the usual way.

I am very glad to know that you have located one man whom you can recommend so highly, but I am wondering what progress you have made toward locating an alternate to take his place in the other section. It is, of course, important that we have someone on the job at all times, and I am sure that you are planning toward this end.

I will immediately get in touch with you again upon receipt of the data requested above.

Very truly yours,

SHURE BROTHERS COMPANY
"Microphone Headquarters"

RPG:LG

Ralph P. Glover
Chief Engineer

Shure requests further information on Benjamin Baumzweiger

UNIVERSITY OF CINCINNATI
COLLEGE OF ENGINEERING AND COMMERCE

7
###

Cincinnati, Ohio
January 3, 1936

Mr. Ralph P. Glover
Chief Engineer
Shure Brothers Company
215 West Huron Street
Chicago, Illinois

Dear Mr. Glover:

In accordance with our telephone conversation yesterday afternoon, I am having the bearer, Mr. Benjamin Baumzweiger, report to you for the position you have open in your engineering department. I am sure that he will prove satisfactory in your work.

I thank you very much for your co-operation.

Very truly yours,

G. T. Addison
G. T. Addison
Associate Professor
Dept. of Co-ordination

MK

Formal letter of introduction

UP _____
 ATT. IN. UP _____ TO ORDER _____
 B _____ R _____ G _____ V _____ X _____
 STATE _____ NAME _____ SPL. _____

May 6, 1937

Mr. Benjamin Baumzweiger
 Memorial Dormitory
 University of Cincinnati
 Cincinnati, Ohio

Dear Ben:

We wish to hereby confirm what we have already offered you verbally; namely a permanent position in our Engineering Department as Research Engineer, continuing the important work which you have been carrying forward as a cooperative student for the past year and a half.

We consider that the record you have already made for yourself with this organization is unusually satisfactory and feel that your services are indispensable to us in carrying forward the engineering program which this company has adopted. We also have in mind the many unfinished projects on which you have been working, and which we will be unable to reassign without a great deal of loss and inconvenience.

We are looking forward to the speedy consummation of the necessary formalities which will make possible your permanent entry into this country.

Best personal regards,

Very truly yours,

SHURE BROTHERS
 "Microphone Headquarters"

SNS:LEG

S. N. Shure

Offer of employment at Shure Brothers

Patented Apr. 8, 1941

2,237,298

UNITED STATES PATENT OFFICE

2,237,298

CONVERSION OF WAVE MOTION INTO
ELECTRICAL ENERGY

Benjamin Baumzweiger, Chicago, Ill., now by
change of name Benjamin B. Bauer, assignor to
S. N. Shure and Frances Shure, trustees, doing
business as Shure Brothers, a partnership

Application September 29, 1938, Serial No. 232,439

18 Claims. (Cl. 179-1)

This invention relates to apparatus for conversion of wave motion into electrical energy and the converse. More particularly it relates to instruments of unidirectional nature, i. e., in which the instrument is active preferentially in one direction only, throughout an extensive range of frequencies, being relatively inoperative in other directions.

Unidirectional operation has previously been obtained in both the transmitting and receiving transducers through a combination of a unit having a nondirectional (circular) polar sensitivity pattern with one having a bidirectional (cosine-law) polar sensitivity pattern. A combination of two such units causes the resulting polar sensitivity pattern to be unidirectional (cardioid) in shape, and it has been applied extensively in the past to transmitting antennas, microphone apparatus, etc. For this latter application, one of the units is commonly made to operate on the pressure component of the sound wave (pressure transducer) and the other upon the pressure-difference of the sound wave (velocity transducer). Addition or cancellation of the voltages generated in each unit occurs depending upon whether the incidence of sound is from the front (0° incidence) or from the rear (180° incidence) of the instrument. Obviously, the voltages generated by both units for the 180° incidence should be substantially equal and opposite in phase throughout the frequency range in which the cancellation is desired, which because of inherent differences in construction and operating principle is a difficult thing to obtain in microphones operating upon dissimilar components of the sound wave.

One important object of my invention is to provide a unidirectional transducer operating over a wide frequency range and comprising in part two transducing elements operating on the same component of the sound wave, thus doing away with the necessity of subtracting outputs of two transducing elements working on dissimilar components of the sound wave.

Another object is to provide a unidirectional transducer with marked unidirectional properties over the operating range of frequencies.

A further object is to obtain an instrument with unidirectional sensitivity pattern by the action of wave effects at two points in a sound wave, using one transducer element only. Other objects of my invention will become apparent as this specification proceeds.

Figure 1 is a diagrammatic layout of generalized apparatus embodying my invention; Fig. 2, a vector diagram showing the voltage relationships for a zero degree incidence of sound; Fig. 3, a similar view to Fig. 2 but representing the 180° incidence of sound; Fig. 4, a diagrammatic view of a specific embodiment comprehend-

ed within the diagram of Fig. 1; Fig. 5, a polar diagram illustrating the directional characteristics of the transducer of Fig. 4; Fig. 6, a diagrammatic and sectional view of a unidirectional crystal microphone; Fig. 7, a rear view in elevation of the same; Fig. 8, an equivalent electrical circuit of the microphone shown in Fig. 6; Fig. 9, a frequency response curve of the microphone shown in Fig. 6, the upper curve showing the front side response and the lower dotted line showing the decrease of response for the rear incidence sound; Fig. 10, a part sectional view of a unidirectional dynamic microphone; Fig. 11, a front view of the same; Fig. 12, a diagrammatic view of the equivalent electrical circuit of the microphone shown in Fig. 10; Fig. 13, a cross-sectional view of the unidirectional crystal microphone equipped with an acoustical resistance formed of cloth; Fig. 14, a front elevation of a unidirectional moving conductor microphone; Fig. 15, a sectional view, the section being taken as indicated at line 15 of Fig. 14; Fig. 16, a sectional view, the section being taken as indicated at line 16 of Fig. 14; and Fig. 17, a diagrammatic view of the equivalent electrical circuit of the microphone shown in Fig. 14.

My invention is principally applicable to production and reception of sound waves in air, although it will become apparent to those skilled in the art that it may be equally applicable to wave phenomena in other media. The transducer element or elements employed may be either of the reversible type, such as piezoelectric crystal, moving coil, moving armature or condenser type, or of the non-reversible type such as, for example, the carbon-type. The theory set forth herein is applicable to receiving apparatus, such as loudspeakers, as well as to transmitting apparatus such as microphones. If transducers of the reversible type are employed, one instrument could serve interchangeably, both as a transmitter and as a receiver.

The nature of my invention is such that it can be best explained by reference to the following equivalent electrical networks and circuit equations. Fig. 1 is a schematic representation of two electroacoustic transducers A and A', generating respectively voltages E and E', and the interconnecting electrical network C. The transducers, which may operate on any function of the sound wave whatsoever, are spaced by an effective acoustical distance d which in general should be smaller than, or comparable to, one-quarter wavelength of the highest frequency at which unidirectional action is desired, although it will be shown later that transducers may be constructed having unidirectional properties at frequencies higher than that specified above by virtue of diffraction and other wave effects. C is a generalized network shown in an equivalent

April 8, 1941.

B. BAUMZWEIGER

2,237,298

CONVERSION OF WAVE MOTION INTO ELECTRICAL ENERGY

Filed Sept. 29, 1938

4 Sheets-Sheet 3

Fig. 11.

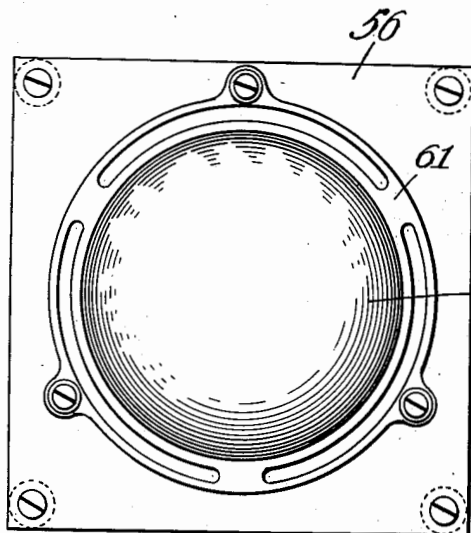

Fig. 10.

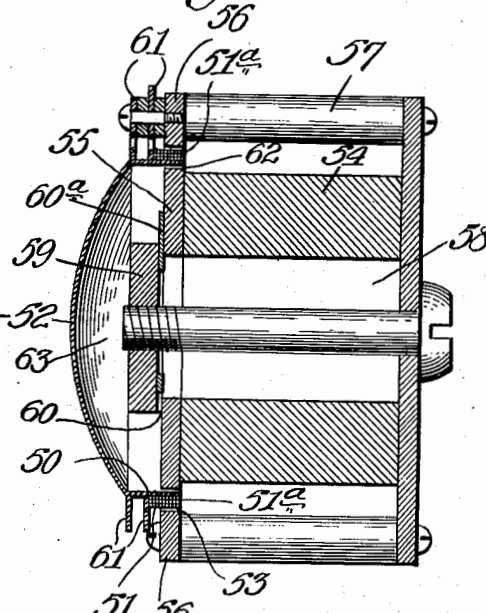
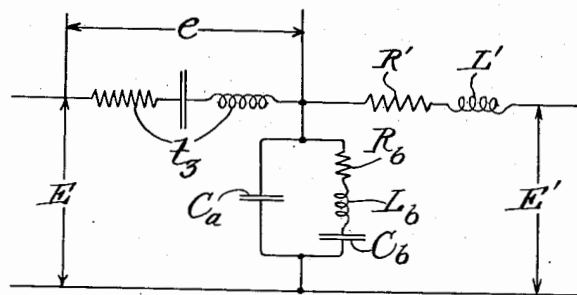

Fig. 12.



Inventor:

Benjamin Baumzweiger,
By Chritton, Niles, Davies, Kirschel, & Dawson,
Attys.

April 8, 1941.

B. BAUMZWEIGER

2,237,298

CONVERSION OF WAVE MOTION INTO ELECTRICAL ENERGY

Filed Sept. 29, 1938

4 Sheets-Sheet 1

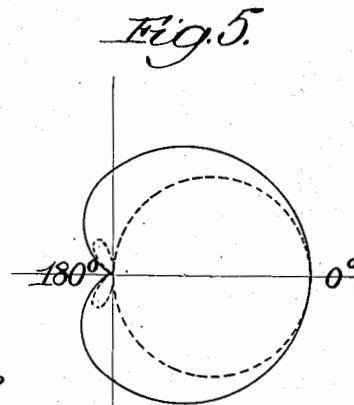
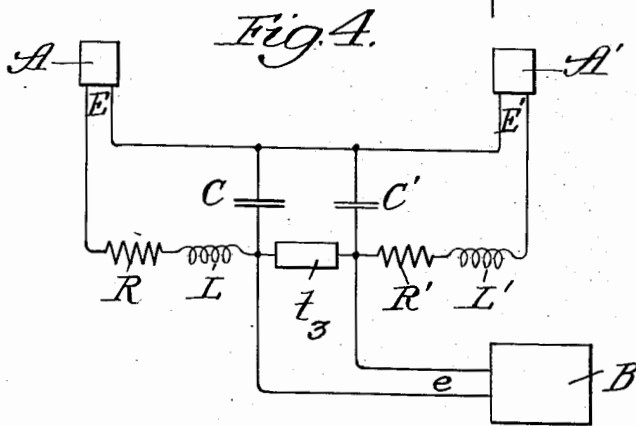
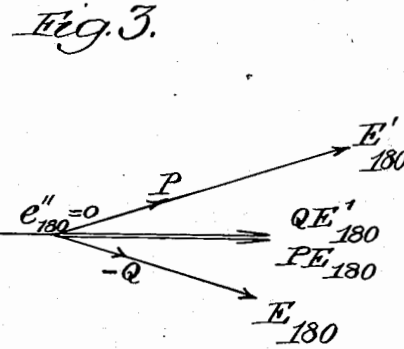
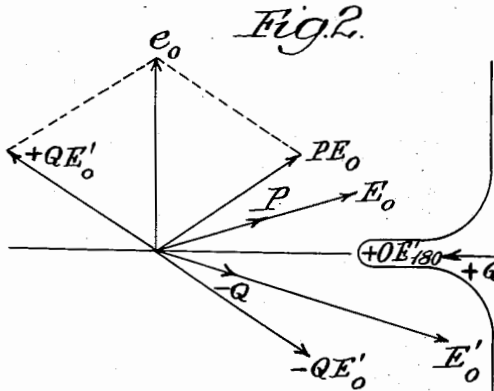
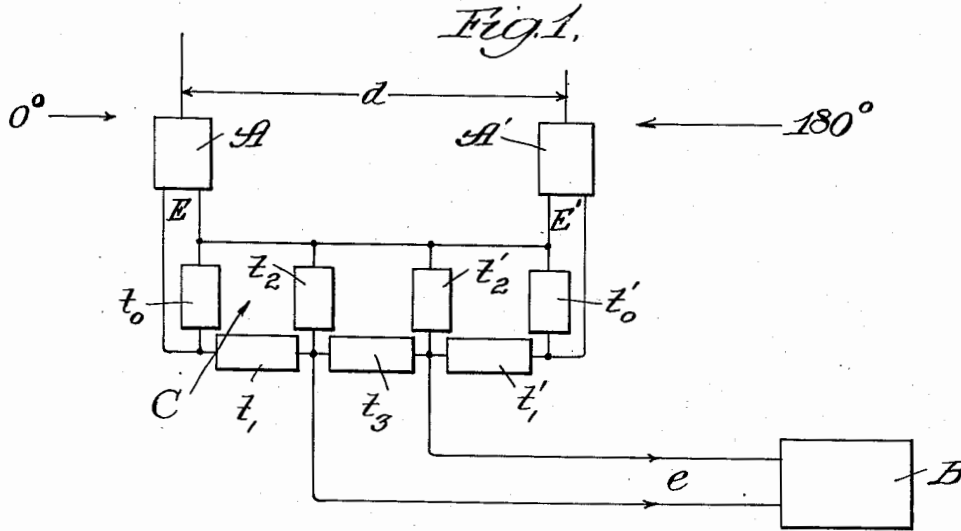

Inventor:
 Benjamin Baumzweiger,
 By Critton, Wiles, Davies, Kirsch & Dawson,
 Attys.



ELEMENT #1



ELEMENT #2



ELEMENT #3

*These elements
are kept in the
Shure Archives*



ELEMENT #4



ELEMENT #5



ELEMENT #6



ELEMENT #7



1937 wooden prototype of the Unidyne housing found in 2002 under the anechoic chamber in the former Shure Evanston headquarters

SHURE BROTHERS
Microphone Headquarters
 225 WEST HURON STREET • CHICAGO • U.S.A.
 TELEPHONE DELAWARE 8383 • CABLE: SHUREMICRO

DATA SHEET No. 195B

DATE: October 1939

SUBJECT: Models 55A, 55B, 55C
 "Unidyne" Dynamic Microphones

55 Series "Unidyne" Microphones
 (Cardioid-Type Uni-directional Moving-Coil Dynamic)

GENERAL: Models 55A, 55B, and 55C are cardioid type unidirectional moving coil dynamic microphones providing wide-range high quality reproduction of sound. The true unidirectional characteristic of the "Unidyne", obtained by the "uniphase" principle* provides highly satisfactory operation under adverse acoustic conditions where a conventional microphone would be practically useless. (See "Acoustic Considerations").

The microphone has a specially designed moving system containing a new type moving-coil element, operating in conjunction with a high flux magnet in the magnetic circuit providing high efficiency and smooth peak free response from 40 to 10,000 cycles. The rear response is down approximately 15 db due to the "uniphase" unidirectional acoustic network.

The case is modern in design with attractive streamlining and grille treatment. The head tilts through an angle of 90° to permit aiming at the source of sound for best pickup. A built-in cable connector is provided and a 25 ft. shielded rubber-jacketed cable with microphone plug attached is included.

APPLICATIONS: Models 55A, 55B, and 55C are suitable for high quality public address, broadcasting, recording and similar applications. The true unidirectional characteristic of the "Unidyne" provides an easy solution to the feedback problem in reverberant locations, facilitates orchestral placement, permits best utilization of space in small broadcast studios, and allows practically complete exclusion of unwanted noises. The swivel allows the head to be tilted through an angle of 90° permitting the microphone to be aimed at the source of sound.

The instrument is unusually rugged and is practically immune to the effects of moisture, temperature and mechanical vibration.

INSTALLATION: All microphones have the standard 5/8"-27 thread and may be mounted on any Shure desk, banquet, or floor stand. Shure floor stands are especially recommended because of the effective isolation against floor vibration which they provide. For overhead suspension, an A35B Suspension Adapter may be used.

CONNECTIONS: Model 55A works directly into a 35-50 ohm line while models 55B and 55C include an internal high quality impregnated transformer with special high-permeability core. The three models, their out-put impedances, and cable furnished are listed below.

Model Impedance	Cable Furnished
55A 35-50 ohms	25 ft. two-conductor
55B 200-250 ohms	25 ft. two-conductor
55C high impedance	25 ft. single conductor

Low impedance models 55A and 55B are recommended where long cable lengths are required. The permissible line length is practically unlimited since neither the level nor the frequency response is appreciably affected by reasonable lengths of line. As shown in the table below, the cable loss is very small. When long lines are used, care should be taken that the cable does not parallel A.C. power lines for long distances to avoid A.C. hum induction.

Cable Length	Loss in Level*	
	Model 55A	Model 55B
25 ft.	0 db	0 db
250 ft.	0.4 db	0 db
500 ft.	0.8 db	0.2 db
1000 ft.	1.6 db	0.4 db
2000 ft.	2.9 db	0.7 db

(*Based on 2-conductor #20 equivalent, twisted and shielded)

*Shure Patents Pending.

Copyright, Shure Brothers, 1939.



Low impedance models 55A and 55B may be fed into a standard low impedance input amplifier (as shown in A-3) or into an amplifier with high impedance input (Fig.A-2). In the latter case Shure Model A86A Cable-Type Transformer is available for coupling the low impedance line to the amplifier input. The double-winding primary permits coupling either a 35-50 ohm line or 200-250 ohm line to the high impedance input.

High impedance model 55C (or 55C-7FT) may be used with any crystal microphone amplifier or other amplifier with an input impedance of 100,000 ohms or more (see Fig.A-1). For best high frequency response, the total cable length should not exceed 25 feet; longer cable lengths may be used with some loss of high frequency response. The additional loss at 5,000 cycles is of the order of 2.5 db for an additional 25 ft. length of cable (50 ft. total) and 6 db for an additional 50 ft. length (75 ft. total).

OPERATION: The microphone should be placed in its operating position before turning up the volume controls of the amplifier. Jarring or excessive moving of the instrument should be avoided while the system is in operation in order to prevent the spring-suspended microphone unit from touching the inside of the case and producing undesirable noises.

No special precautions beyond ordinary care are necessary in the operation of 55 Series Dynamic microphones. They will operate efficiently and dependably under all ordinary conditions in hot and cold climates. To retain the full strength of the highly efficient permanent magnet and to maintain alignment of the structure, dropping or other severe mechanical shocks should be avoided.

ACOUSTIC CONSIDERATIONS: The expression "cardioid type" response simply means that the horizontal polar characteristic approximates a cardioid of revolution. There is a wide, useful pickup angle at the front of the microphone while the response at the sides is down 6 db from the front response. The rear response in practical cardioid type microphones is

(over)

Printed in U.S.A.

No. 195B

DATA SHEET

SHURE BROTHERS
Microphone Headquarters
225 WEST HURON STREET • CHICAGO • U.S.A.

down of the order of 15 db from the front side response. The Unidyne fulfills these requirements over a broad range of frequencies. The true unidirectional characteristic of the "Unidyne" should not be confused with the relatively slight directional effect at high frequencies only which can be produced by baffle effects in the conventional pressure microphone.

The result of this unidirectional characteristic is a complete elimination of acoustic feedback at volume levels which would cause considerable feedback with conventional semidirectional microphones. In practically all cases it is possible to increase loudspeaker levels when a Unidyne is installed. By directing the dead side (rear) of the microphone towards the audience or other source of interfering sound, pickup can be concentrated on the desired source. Reverberation energy pickup is decreased approximately two-thirds. The microphone can be placed close to reflecting surfaces without objectionable effects if the rear side of the microphone is toward the reflecting surface. This is particularly valuable in small broadcast studios.

It is desirable to experiment with microphone placement and orientation in order to secure the greatest benefits from the unidirectional characteristic.

SPECIFICATIONS

- Voltage Sensitivity:
 Model 55A 83 db below 1 volt per bar open circuit, or 63 db below 6 milliwatts for 10 bar signal when loaded with 35-50 ohms.
 Model 55B 74 db below 1 volt per bar open circuit, or 64 db below 6 milliwatts for 10 bar signal when loaded with 200-250 ohms.
 Model 55C 55 db below 1 volt per bar when loaded with 100,000 ohms or more. This is equivalent to 1.8 millivolts per bar across 100,000 ohms or more.

- Recommended Load Impedance:
 Model 55A 35-50 ohms.
 Model 55B 200-250 ohms.
 Model 55C 100,000 ohms or more.

Shure Patents Pending

MODEL	55A	55B	55C
Code Word	RUDAR	RUDAT	RUDAS
List Price	\$42.50	\$45.00	\$45.00
Net Wt. Less Cable	2 1/4 lb.	2 1/4 lb.	2 1/4 lb.
Shipping Weight	4 lbs.	4 lbs.	3 1/2 lbs.
Cable	25 ft. Two-Conductor	25 ft. Two-Conductor	25 ft. Single Conductor
Height, Overall (a)*	7-25/32"		
Height, Case (h)*	4- 7/16"		
Width (b)*	3- 3/16"		
Thickness (c)*	3- 9/16"		
Finish	Satin Chrome		

* See Fig. C.

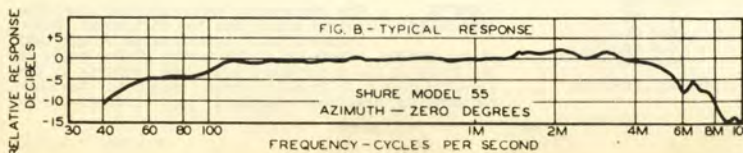

GUARANTEE: Each microphone is guaranteed to be free from electrical and mechanical defects for a period of one year from date of shipment from the factory, provided all instructions are complied with fully. In case of damage, return the microphone to the factory for repairs. Our guarantee is voided if the microphone case is opened.

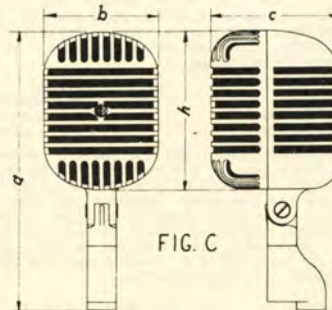
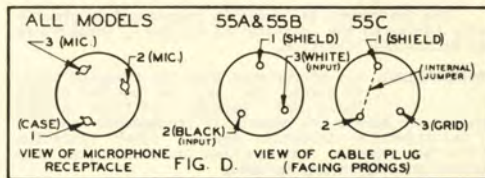
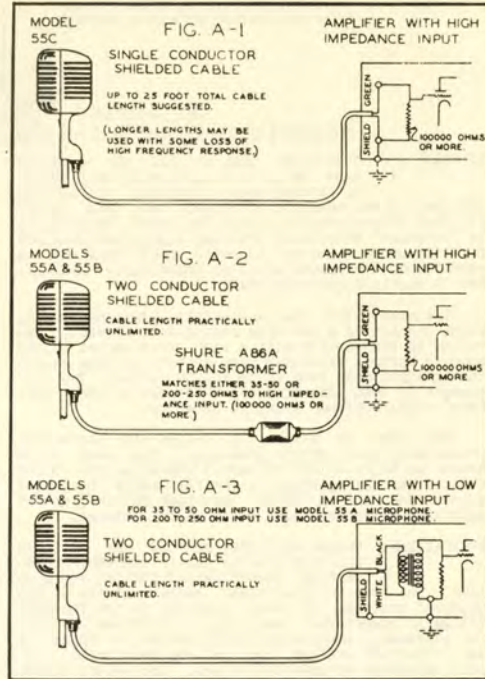

SHURE BROTHERS
Microphone Headquarters
 225 WEST WYOMING STREET • CHICAGO • U.S.A.
 TELEPHONE DELAWARE 8383 • CABLE: SHUREMICRO

DATA SHEET No. 180

DATE: July 1941

SUBJECT: Models 555A, 555B, 555C
 Broadcast "Unidyne" Dynamic Microphones

555 Series Broadcast "Unidyne" Microphones
 (Cardioid Uni-directional Moving-Coil Dynamic)

GENERAL: Models 555A, 555B, and 555C are cardioid type unidirectional moving coil dynamic microphones providing wide-range high quality reproduction of sound. The true unidirectional characteristic of the "Unidyne", obtained by the "uniphase" principle* provides highly satisfactory operation under adverse acoustic conditions where a conventional microphone would be practically useless. (See "Acoustic Considerations").

The microphone has a specially designed moving system containing a new type moving-coil element, which, operating in conjunction with a high flux magnet in the magnetic circuit provides high efficiency and smooth peak free response from 40 to 10,000 cycles. The rear response is down approximately 15 db due to the "uniphase" unidirectional acoustic network.

The moving-coil unit is provided with a double wind-screen to permit quiet out-door operation, and is mounted in a spring suspended cradle to provide mechanical isolation from the case. As a further precaution against mechanical vibration pickup, the entire case is floated in live rubber in an isolation unit which also serves as the stand connector.

The case is modern in design with attractive streamlining and grille treatment, and is provided with a swivel that allows the microphone to be aimed at the source of sound for best pickup. An eighteen inch length of two conductor shielded cable is provided for attachment of any type plug the user may desire. This cable is held by screw terminals in the base of the isolation unit, and may be easily replaced by longer lengths.

APPLICATIONS: Models 555A, B, and C are especially constructed and tested to meet the requirements of the broadcast studio, and are held within close tolerances in frequency response and directivity. They may also be used for high-quality recording, public address, and similar applications. The true unidirectional characteristic of the "Unidyne" provides an easy solution to the feedback problem in reverberant locations, facilitates orchestral placement, permits best utilization of space in small broadcast studios, and allows practically complete exclusion of unwanted noises. The swivel allows the head to be tilted through an angle of 90° permitting the microphone to be aimed at the source of sound.

The instrument is unusually rugged and is practically immune to the effects of moisture, temperature and mechanical vibration.

INSTALLATION: All microphones have the standard 5/8"-27 thread and may be mounted on any Shure desk, banquet, or floor stand. The Shure Model SS10A floor stand is especially recommended because of the effective isolation against floor vibration which it provides. For overhead suspension, an A35B suspension Adapter may be used.

CONNECTIONS: Model 555A works directly into a 35-50 ohm line while models 555B and 555C include an internal high quality impregnated transformer with special high-permeability core.

Low impedance models 555A and 555B are recommended where long cable lengths are required. The permissible line length is practically unlimited since neither the level nor the frequency response is appreciably affected by reasonable lengths of line. As shown in the table below, the cable loss is very small. When long lines are used, care should be taken that the cable does not parallel A.C. power lines for long distances to avoid A.C. hum induction.

* Patented by Shure Brothers

Copyright, Shure Brothers, 1941



Model 555A Broadcast Unidyne
 (Shown with A72A Call Letter Plate)

Cable Length	Loss in Level*	Loss in Level*
	Model 555A	Model 555B
25 ft.	0 db	0 db
250 ft.	0.5 db	0 db
500 ft.	1.0 db	0.2 db
1000 ft.	2.0 db	0.4 db
2000 ft.	3.5 db	0.8 db

(*Based on 2-conductor #20 equivalent, twisted and shielded)

Low impedance models 555A and 555B may be fed into a standard low impedance input amplifier (See Fig. A-3) or into an amplifier with high impedance input (Fig. A-2). In the latter case Shure Model A86A Cable-Type Transformer is available for coupling the low impedance line to the amplifier input. A double-winding primary permits coupling either a 35-50 ohm line or 220-250 ohm line to the high impedance input.

High impedance model 555C may be used with any crystal microphone amplifier or other amplifier with an input impedance of 100,000 ohms or more (See Fig. A-1). For best high frequency response, the total cable length should not exceed 25 feet; longer cable lengths may be used with loss of high frequency response. The additional loss at 5,000 cycles is of the order of 3.5 db for an additional 25 ft. length of cable (50 ft. total) and 7 db for an additional 50 ft. length (75 ft. total).

OPERATION: The microphone should be placed in its operating position before turning up the volume controls of the amplifier. Jarring or excessive moving of the instrument should be avoided while the system is in operation in order to prevent the spring-suspended microphone unit from touching the inside of the case and producing undesirable noises.

No special precautions beyond ordinary care are necessary in the operation of 555 Series Dynamic microphones. They will operate efficiently and dependably

Printed in U.S.A.

(over)

No. 180

DATA SHEET

SHURE BROTHERS
Microphone Headquarters
225 WEST HURON STREET • CHICAGO • U.S.A.

under all ordinary conditions in hot and cold climates. To retain the full strength of the highly efficient permanent magnet and to maintain alignment of the structure, dropping or other severe mechanical shocks should be avoided.

ACOUSTIC CONSIDERATIONS: The expression "cardioid type" response simply means that the polar characteristic approximates a cardioid of revolution. There is a wide, useful pickup angle at the front of the microphone while the response at the sides is down 6 db from the front response. The rear response in practical cardioid type microphones is down of the order of 15 db from the front side response. The Unidyne fulfills these requirements over a broad range of frequencies. The true unidirectional characteristic of the "Unidyne" should not be confused with the relatively slight directional effect at high frequencies only which can be produced by baffle effects in the conventional pressure microphone.

By directing the dead side (rear) of the microphone towards the audience or other source of interfering sound, pickup can be concentrated on the desired source. Reverberation energy pickup is decreased approximately two-thirds. The microphone can be placed close to reflecting surfaces without objectionable effects if the rear side of the microphone is toward the reflecting surface. This is particularly valuable in small broadcast studios.

It is desirable to experiment with microphone placement and orientation in order to secure the greatest benefits from the unidirectional characteristic.

SPECIFICATIONS

Voltage Sensitivity:
 Model 555A 83.0 db below 1 volt per bar open circuit, or 62.8 db below 6 milliwatts for 10 bar signal when loaded with 35-50 ohms.
 Model 555B 76.5 db below 1 volt per bar open circuit, or 63.8 db below 6 milliwatts for 10 bar signal when loaded with 200-250 ohms.
 Model 555C 55.5 db below 1 volt per bar when loaded with 100,000 ohms or more. This is equivalent to 1.7 millivolts per bar across 100,000 ohms or more.

Recommended Load Impedance:
 Model 555A 35-50 ohms.
 Model 555B 200-250 ohms.
 Model 555C 100,000 ohms or more.

MODEL	555A	555B	555C
Code Word	RUDID	RUDIF	RUDIV
List Price	66.00	66.00	66.00
Net Wt.	2-3/4 lb.	2-3/4 lb.	2-3/4 lb.
Shipping Weight	4-1/2 lb.	4-1/2 lb.	4-1/2 lb.
Height, Overall (a)*	8-3/8"		
Height, Case (h)*	4-7/16"		
Width (b)*	3-3/16"		
Thickness (c)*	3-9/16"		
Finish	Satin Chrome		

*See Fig. C.

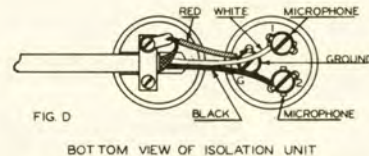
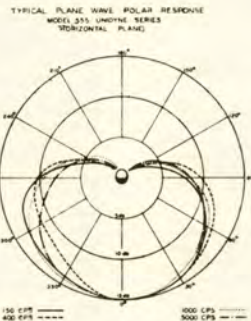
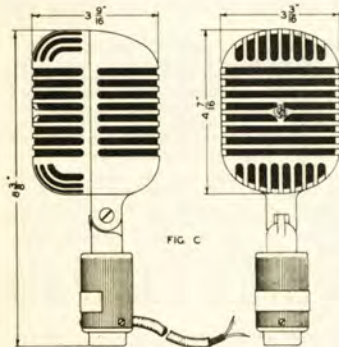
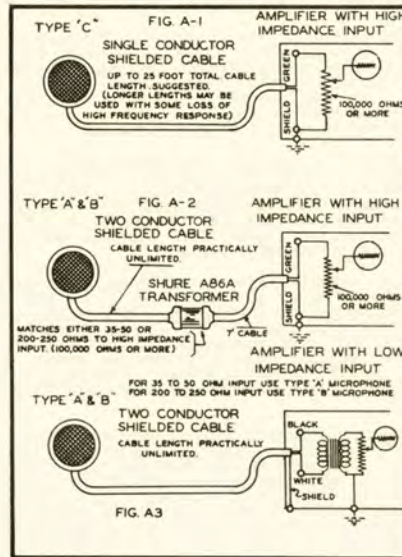

GUARANTEE: Each microphone is guaranteed to be free from electrical and mechanical defects for a period of one year from date of shipment from the factory, provided all instructions are complied with fully. In case of damage, return the microphone to the factory for repairs. Our guarantee is voided if the microphone case is opened.

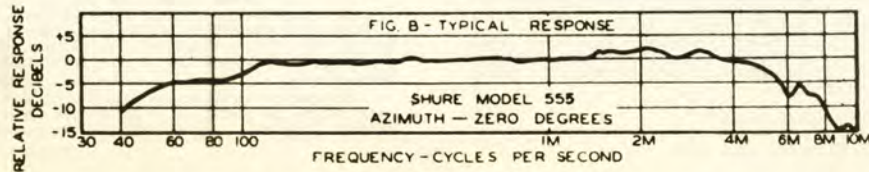

SHURE BROTHERS
Microphone Headquarters
 225 WEST HURON STREET • CHICAGO • U.S.A.
 TELEPHONE DELAWARE 3183 • CABLE: SHUREMICRO

DATA SHEET No. 181

DATE: January, 1942
 SUBJECT: Models 556A, 556B, 556C
 Broadcast "Unidyne" Dynamic Microphones

"556" Series Broadcast "Unidyne" Microphones
 (Super Cardioid Uni-directional Moving-Coil Dynamic)

GENERAL: Models 556A, 556B, and 556C are Super-Cardioid type unidirectional moving-coil dynamic microphones providing wide-range high quality reproduction of sound. The true unidirectional characteristic of the "Unidyne", obtained by the "uniphase" principle provides highly satisfactory operation under adverse acoustic conditions where a conventional microphone would be practically useless. (See "Acoustic Considerations").

The microphone has a New Acousto-Mechanical circuit containing a moving-coil element, which operating in conjunction with a high flux magnet provides high efficiency and smooth peak free response from 40 to 10,000 cycles. The rear response is down approximately 15 db due to the "uniphase" unidirectional acoustic network.

The new moving-coil unit is provided with a double wind-screen to permit quiet out-door operation. As a precaution against mechanical vibration pickup, the unit is spring-suspended inside the microphone case, which is in turn floated in live rubber in the stand connector.

The case is modern in design with attractive streamlining and grille treatment, and is provided with a swivel that allows the microphone to be aimed at the source of sound for best pickup. An eighteen inch length of two conductor shielded cable is provided for attachment of any type plug the user may desire. This cable is held by screw terminals in the base of the insulation unit, and may be easily replaced by longer lengths.

APPLICATIONS: Models 556A, B, and C are especially constructed and tested to meet the requirements of the broadcast studio, and are held within close tolerances in frequency response and directivity. They may also be used for high-quality recording, public address, and similar applications. The true unidirectional characteristic of the "Unidyne" provides an easy solution to the feedback problem in reverberant locations, facilitates orchestral placement, permits best utilization of space in small broadcast studios, and allows practically complete exclusion of unwanted noises. The swivel allows the head to be tilted through an angle of 90° permitting the microphone to be aimed at the source of sound.

The instrument is unusually rugged and is practically immune to the effects of moisture, temperature and mechanical vibration.

INSTALLATION: All microphones have the standard 5/8"-27 thread and may be mounted on any Shure desk, banquet, or floor stand. The Shure Model S510A floor stand is especially recommended because of the effective isolation against floor vibration which it provides. For overhead suspension, an A35B suspension Adapter may be used.

CONNECTION: Model 556A works directly into a 35-50 ohm line while models 556B and 556C include an internal high quality impregnated transformer with special high-permeability core.

Low impedance models 556A and 556B are recommended where long cable lengths are required. The permissible line length is practically unlimited since neither the level nor the frequency response is appreciably affected by reasonable lengths of line. As shown in the following table, the cable loss is very small. When long lines are used, care should be taken that the cable does not parallel A.C. power lines for long distances to avoid A.C. hum induction.



Model 556A Broadcast Unidyne
 (Shown with A72A Call Letter Plate)

Cable Length	Loss in Level* Model 556A	Loss in Level* Model 556B
25 ft.	0 db	0 db
250 ft.	0.5 db	0 db
500 ft.	1.0 db	0.2 db
1000 ft.	2.0 db	0.4 db
2000 ft.	3.5 db	0.8 db

(*Based on 2-conductor #20 equivalent, twisted and shielded)

Low impedance models 556A and 556B may be fed into a standard low impedance input amplifier (See Fig. A-3) or into an amplifier with high impedance input (Fig. A-2). In the latter case Shure Model A86A Cable-Type Transformer is available for coupling the low impedance line to the amplifier input. A double-winding primary permits coupling either a 35-50 ohm line or 200-250 ohm line to the high impedance input.

High impedance model 556C may be used with any crystal microphone amplifier or other amplifier with an input impedance of 100,000 ohms or more (See Fig. A-1). For best high frequency response, the total cable length should be as short as possible and in any event not over 25 feet. Longer cable lengths may be used with loss of high frequency response. The loss at 5,000 cycles is of the order of 3.5 db with a 25 ft. length of cable and 7 db with 50 ft. length.

OPERATION: No special precautions beyond ordinary care are necessary in the operation of 556 Series Dynamic microphones. They will operate efficiently and dependably under all ordinary conditions in hot and cold climates. Dropping the microphone or other severe mechanical shocks should be avoided.

Patented by Shure Brothers
 Copyright, Shure Brothers, 1942

(Over)

Printed in U.S.A.

No. 181

DATA SHEET

SHURE BROTHERS
Microphone Headquarters
 225 WEST HURON STREET • CHICAGO • U.S.A.

ACOUSTIC CONSIDERATIONS: The expression "Super-Cardioid type" response simply means that the polar characteristic of the microphone approximates a modified cardioid of revolution. There is a wide, useful pickup angle at the front of the microphone while the response at the sides is down 8.5 db from that at the front. The rear response is down of the order of 15 db over a broad range of frequencies. The true unidirectional characteristic of the "Unidyne" should not be confused with the relatively slight directional effect at high frequencies only which can be produced by baffle effects in the conventional pressure microphone.

By directing the rear side of the microphone towards the audience or other source of interfering sound, pickup can be concentrated on the desired source. Reverberation energy pick up is decreased over two-thirds. The microphone can be placed close to reflecting surfaces without objectionable effects if the rear side of the microphone is toward the reflecting surface. This is particularly valuable in small broadcast studios.

It is desirable to experiment with microphone placement and orientation in order to secure the greatest benefits from the unidirectional characteristic.

SPECIFICATIONS

Voltage Sensitivity:

Model 556A 63.0 db below 1 volt per bar open circuit, or 62.8 db below 6 milliwatts for 10 bar signal when loaded with 35-50 ohms.

Model 556B 76.5 db below 1 volt per bar open circuit, or 63.8 db below 6 milliwatts for 10 bar signal when loaded with 200-250 ohms.

Model 556C 55.5 db below 1 volt per bar when loaded with 100,000 ohms or more. This is equivalent to 1.7 millivolts per bar across 100,000 ohms or more.

Recommended Load Impedance:

Model 556A 35-50 ohms.
Model 556B 200-250 ohms.
Model 556C 100,000 ohms or more.

MODEL	556A	556B	556C
Code Word	RUDOM	RUDOP	RUDOR
Net Wt.	2-3/4 lb.	2-3/4 lb.	2-3/4 lb.
Shipping Weight	4-1/2 lb.	4-1/2 lb.	4-1/2 lb.
Height, Overall (a)*	8-3/8"		
Height, Case (h)*	4-7/16"		
Width (b)*	3-3/16"		
Thickness (c)*	3-9/16"		
Finish	Satin Chrome		

*See Fig. C.

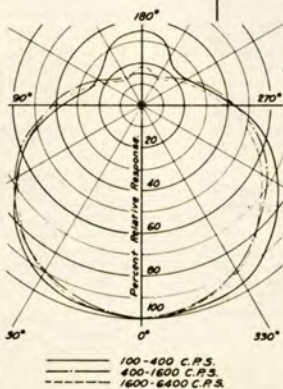
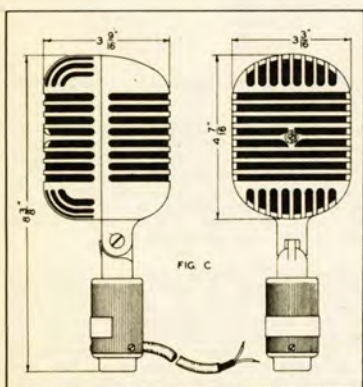

Horizontal Polar Response Series 556 Microphones

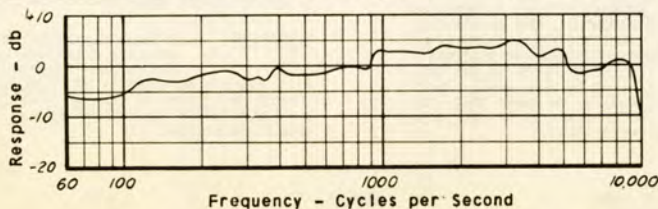
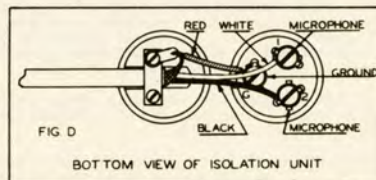
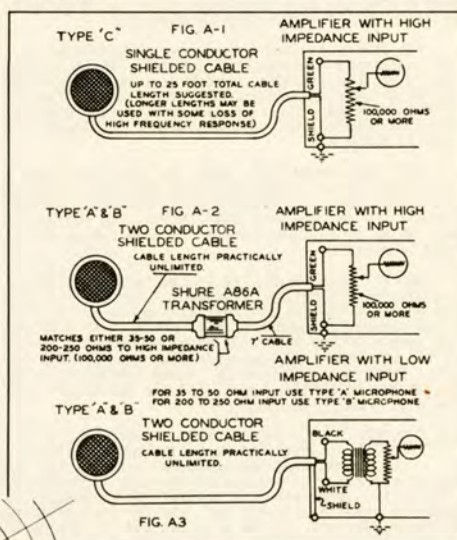

Fig. B. Typical Frequency Response, Series "556" Microphones



GUARANTEE: Each microphone is guaranteed to be free from electrical and mechanical defects for a period of one year from date of shipment from the factory, provided all instructions are complied with fully. In case of damage, return the microphone to the factory for repairs. Our guarantee is voided if the microphone case is opened.



SHURE BROTHERS
INCORPORATED
Microphones and Acoustic Devices
225 WEST HURON STREET :: CHICAGO 10, ILLINOIS
PHONE DELaware 7-4550 :: CABLE: SHUREMICRO

DATA SHEET

DATE: MAY, 1951

SUBJECT: Model 55s Multi-Impedance
"Small Unidyne" Dynamic
Microphone.

55s Multi-Impedance "Small Unidyne" Microphone (Ultra-Cardioid, Unidirectional, Moving-Coil Dynamic)

General: The Model 55s is a small, compact Microphone in which high-fidelity response and excellent directional pattern are achieved. The Ultra-Cardioid unidirectional characteristic of the microphone (obtained by the "Uniphase" principle[®]) provides highly satisfactory operation under adverse acoustic conditions. It permits placement of the microphone at a distance from the performer 75% greater than is possible with non-directional (omni-directional) microphones.

The new "Small Unidyne," Model 55s, embodies all of the advantages found in the world-famous Shure Model 55 Unidyne. Its improvements are notable. The Shure-patented acoustic phase-shift network has been redesigned; the moving-coil system has been revised for high efficiency and extended, smooth, frequency response. Large air-gap clearances, together with a rugged coil construction, provide immunity of the moving system to abnormal atmospheric conditions and severe mechanical shock.

The case is modern in design, with attractive streamlining and grille treatment. Model 55s is smaller than the Model 55, and is therefore ideal for installations where it is desired to keep the microphone size to a minimum and still retain maximum operating efficiency.

A new self-adjusting swivel permits tilting of the head through 80° so that the microphone can be aimed at the source of sound. A built-in cable connector is provided; and a 20 foot, high-quality, two-conductor shielded cable with microphone plug attached is included.

Applications: Model 55s is ideal for high-quality public address, theatre-stage sound systems, and recording applications. Because of its unusual ruggedness and reliability, Model 55s microphone is, also, recommended for fixed station use in the Police, Fire, and Transportation services. For studio broadcasting and T.V. use, and similar applications where the utmost in quality is desired, Model 55s Broadcast Unidyne is recommended.

The true unidirectional characteristics of the Model 55s provides an easy solution to the feedback problem in reverberant locations, facilitates orchestral placement, permits best utilization of space in small broadcast studios, and provides practically complete exclusion of unwanted noises.

Installation: All microphones have the standard 5/8"-27 thread and may be mounted on any conventional desk, banquet, or floor stand. Physical dimensions are shown in Fig. C. When long lines are used, care should be taken that the cable does not parallel A.C. power lines for long distances to avoid A.C. hum induction.

Connections: The Model 55s Microphone is of the multi-impedance type. Model 55s may be connected directly to a 30-50 ohm line, a 150-250 ohm line, or high impedance input. Selection of these impedances is accomplished by changing the position of the switch at the rear of the microphone. The switch positions are marked "L" for low impedance (30-50 ohms), "M" for medium impedance (150-250 ohms), and "H" for high impedance (35,000 ohms).

In the low and medium impedance positions, Model 55s may be connected directly to a standard low or medium impedance input amplifier (Fig. A-1), or into an amplifier with high impedance input (Fig. A-2). In the latter case, Shure Model A86A Cable-Type Transformer is available for coupling the low impedance line to the amplifier input. The double winding primary of the Shure



Model A86A Cable type transformer permits coupling either a 30-50 ohm line or 150-250 ohm line to high impedance input.

The low and medium impedance positions are recommended where long cable lengths are required or under conditions of severe hum disturbances. The permissible line length is practically unlimited, since neither response nor level is appreciably affected by reasonable lengths of line.

The high impedance position on the Model 55s Microphone may be used with any high gain microphone amplifier or other amplifier with an input impedance of 100,000 ohms or more (See Fig. A-3). For best high frequency response in high impedance the total cable lengths should not exceed 25 feet; longer cable lengths may be used with some loss of high frequency response. The additional loss at 5000 cycles is of the order of 2.5 db for an additional 25 ft. length of cable (50 ft. total) and 6 db for an additional 50 ft. length (75 ft. total). If the Model 55s Microphone is used in the high impedance position, single conductor shielded cable may be used to provide additional cable lengths; also, the two-conductor cable furnished with the Microphone may be replaced with single conductor shielded cable, if the microphone is intended to operate directly into high impedance (grid) input only. In this instance, the number one pin and the number two pin of the cable plug must be shorted together and connected to the shield of the cable.

The shield, chassis or amplifier ground should be securely connected to a water pipe or similar ground to prevent shock hazard during operation of amplifying system.

When used with amplifiers using the grid leak type of bias at the input tube, it may be desirable to use a .01 mfd. condenser between the microphone and the input grid circuit.

Operation: The microphone should be placed in its operating position before turning up the volume controls of the amplifier. Jarring or excessive moving of the instrument should be avoided while the system is in operation.

No special precautions beyond ordinary care are necessary in the operation of the Model 55s Dynamic microphone. It will operate efficiently and dependably under all ordinary conditions in hot and cold climates. To retain the full strength of the highly efficient permanent magnet and to maintain alignment of the structure, dropping or other severe mechanical shocks should be avoided.

*Patented by Shure Brothers Inc.
Copyright, 1951 Shure Brothers, Inc.

(Over)

Printed in U.S.A.

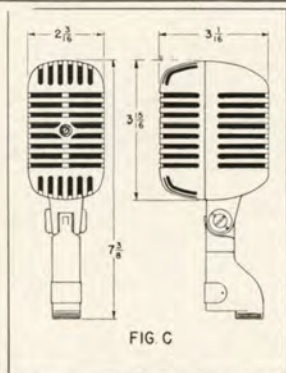
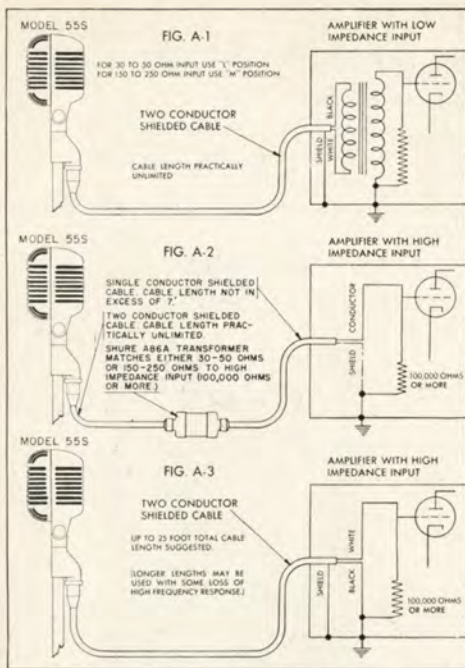

Acoustic Considerations: The front response-frequency characteristic of the Model 55s is shown in Figure B. The smooth, wide-range characteristic is excellent for high-quality reproduction of music and speech.

"Ultra-Cardioid" describes the horizontal polar characteristic of the Model 55s. This polar characteristic resembles a cardioid but is slightly more directional. There is a wide, useful pickup angle at the front of the microphone, while the response at the sides is down 6 db from the front response. The rear response is down approximately 15 db. The Model 55s fulfills these requirements over a broad range of frequencies. The true unidirectional characteristic of the microphone should not be confused with the relatively slight directional effect at high frequencies which can be produced by baffle effects in the conventional pressure microphone.

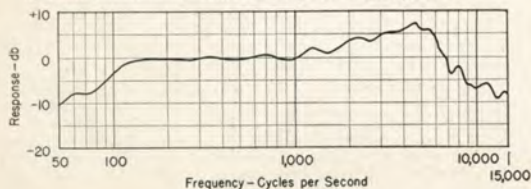

Response-Frequency Characteristic Model 55s Microphone.
27A02, 5-51.

The result of this unidirectional characteristic is elimination of acoustic feedback at volume levels which would cause considerable feedback with conventional semidirectional or omnidirectional microphones. In practically all cases it is possible to increase loud-speaker levels when a Unidyne is installed. By directing the dead side (rear) of the microphone towards the audience or other source of interfering sound, pickup can be concentrated on the desired source. Reverberation energy pickup is decreased approximately two-thirds. The microphone can be placed close to reflecting surfaces without objectional effects if the rear side of the microphone is toward the reflecting surface. This is particularly valuable in small broadcast studios. It is desirable to experiment with microphone placement and orientation in order to secure the greatest benefits from the unidirectional characteristic.

Specifications

1000 C.P.S. Response:

- Model 55s "L" Position
 - Open Circuit Voltage Level..... — 87.9 db[⊙]
 - Loaded with 50 ohms..... — 92.4 db[⊙]
 - Power Level into 50 ohms..... — 59.4 db^{⊙⊙}
 - RTMA Microphone Rating G_M (Sensitivity)..... — 153.6 db^{⊙⊙⊙}
 - Model 55s "M" Position
 - Open Circuit Voltage Level..... — 81.0 db[⊙]
 - Loaded with 250 ohms..... — 86.1 db[⊙]
 - Power Level into 250 ohms..... — 60.1 db^{⊙⊙}
 - RTMA Microphone Rating G_M (Sensitivity)..... — 152.8 db^{⊙⊙⊙}
 - Model 55s "H" Position
 - Open Circuit Voltage Level..... — 60.5 db[⊙]
 - Loaded with 100,000 ohms..... — 62.3 db[⊙]
 - RTMA Microphone Rating G_M (Sensitivity)..... — 157.0 db^{⊙⊙⊙}
- [⊙] 0 db = 1 Volt Per Microbar
^{⊙⊙} 0 db = 1 Milliwatt with 10 Microbars
^{⊙⊙⊙} RTMA Standard SE-105, August 1949.

Recommended Load Impedance:

- Model 55s "L" Position 30-50 ohms.
- Model 55s "M" Position 150-250 ohms.
- Model 55s "H" Position 100,000 ohms or more.

MODEL 55s	
Code Word	RUDOT
Net Wt.	3 1/8 lb.
Shipping Weight	4 1/4 lb.
Cable	20 ft. Two-Conductor
Height, Overall ⊙	7 3/8"
Height, Case ⊙	3 1/8"
Width ⊙	2 3/8"
Depth ⊙	3 1/8"
Finish	Satin Chrome

⊙ See Fig. C.

Guarantee: Each microphone is guaranteed to be free from electrical and mechanical defects for a period of one year from date of shipment from factory, provided all instructions are complied with fully. In case of damage, return the microphone to the factory for repairs. Our guarantee is voided if the microphone is subjected to accident or abuse or if the case is opened.

MODEL 55s Architect's Specification

The microphone shall be a moving coil type microphone with a frequency range of 50 to 15,000 c.p.s. This unit shall have an "Ultra-Cardioid" horizontal polar characteristic. The cancellation at the sides shall be approximately 6 db and the cancellation at the rear shall be in the order of 15 db. The microphone shall be equipped with a three-position impedance change switch for adjusting the microphone rating impedance to 38 ohms, 150 ohms or 40,000 ohms. The microphone rating G_M (sensitivity) at 1000 c.p.s. shall be within ± 3 db of the following levels:

- "L" Position of switch — 153.6 db
 - "M" Position of switch — 152.8 db
 - "H" Position of switch — 157.0 db
- RTMA Standard SE-105 August 1949

The microphone shall be provided with a swivel adjustable from 0° to 80° and it shall have a detachable cable connector capable of connection to a two-conductor shielded cable. The microphone will mount on stand having 5/8"-27 thread. The overall dimensions shall be 7 3/8" ± 1/4 inches in height, 2 3/8" ± 1/8 inches in width, and 3 1/8" ± 1/8 inches in depth.

THE INDUSTRY IN REVIEW

A New Unidirectional Microphone

By BENJAMIN BAUMZWEIGER
Development Engineer, Shure Brothers

ANNOYING effects of reverberation and background noise, which are almost invariably present in microphone setups may be greatly minimized, if not entirely eliminated, with a microphone sensitive only in the direction of the desired sounds and relatively insensitive in other directions. The importance attached to directional properties of microphones even in the early days of broadcasting and public address is evident in many attempts to use various kinds of reflectors and baffles to increase directional discrimination. Correctly designed microphone baffles are capable of producing some useful high-frequency directivity. However true unidirectional operation is unobtainable by such means inasmuch as diffraction effects become pronounced only at wavelengths considerably smaller than the important dimensions of the obstacles. The inability of such devices to cope effectively with the majority of microphone pickup problems becomes evident if it is remembered that the bulk of the acoustical energy is transmitted in the frequency range below 1000 cps.

True unidirectional operation can be obtained with a combination of a pressure-type microphone and a velocity-

type microphone. This is analogous to the well-known unidirectional antenna array consisting of a vertical element and a loop. The voltage in a pressure-type microphone is independent of the direction of incidence of sound, while that of the velocity-type microphone reverses with the reversal of incidence. Outputs of the individual units therefore add for sounds arriving from the front and subtract for sounds arriving from the rear. Through careful design, substantial output cancellation is obtained for rear sounds throughout practically all of the acoustical frequency spectrum.

This procedure, although simple and straight-forward theoretically, has a number of practical drawbacks. The frequency response curves as well as the phase positions of the individual voltages must closely correspond in order to obtain an acceptable front-to-rear discrimination at all the important frequencies. The correspondence required, in view of difference in operating principle of the units, necessitates elaborate and expensive selective processes to achieve proper matching of the units, which naturally is reflected in the high prices which such microphones command.

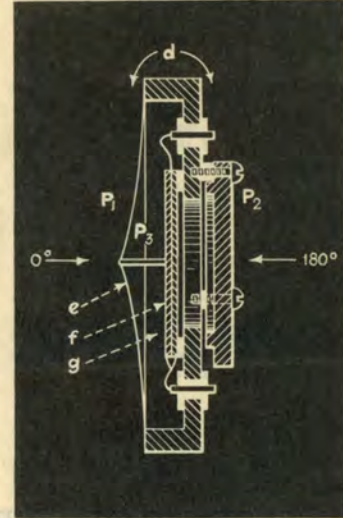

Fig. 1—Cross sectional view of the new Shure Brothers microphone, showing the essential component parts. This is a crystal-type unit

A new principle of unidirectional operation employing only one microphone unit was developed some time ago in the Shure laboratories, and has been embodied in the Model 730A "Uni-

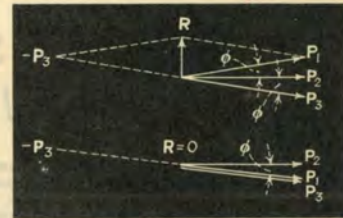
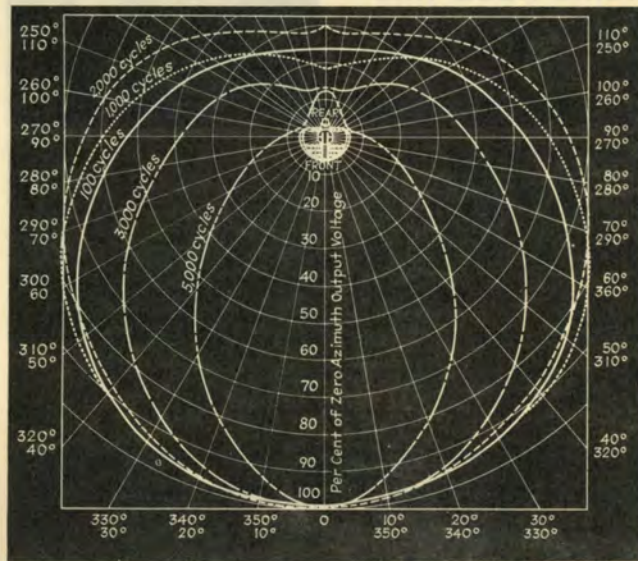

Fig. 2a (above) and Fig. 2b—Manner in which unidirectional microphone action is attained

Fig. 3—Cardioid-shaped directivity pattern of the "uniphase" mike, given for several audio-frequency values

plex" Unidirectional Crystal Microphone. The new unit achieves unidirectional operation through the use of phase-shifting acoustical networks coupled to a diaphragm-type crystal element. The simplified structure obtained this way obviously has a number of technical advantages arising from the purely acoustical nature of the system. A cross-sectional view of the unidirectional mechanism is shown in Fig. 1 illustrating the essential component

Reprinted by permission from ELECTRONICS, February, 1939

Article on the Uniphase principle published two months before the Unidyne introduction

Unidirectional Microphone

parts. A light duraluminum diaphragm e is coupled to the bimorph Rochelle salt crystal f by means of a connecting rod. One side of the diaphragm is exposed directly to the sound waves, while the other is adjacent to the enclosure g forming part of the acoustical network structure which affords communication with the rear side of the unit.

A sound wave moving in the direction indicated by the 0° arrow arrives at the front of the microphone a trifle earlier than it does at the rear because of the additional distance d which it must travel. Therefore the sound pressure P_1 leads P_2 by a phase angle

$$\phi = \omega d/c \quad (1)$$

where ϕ is the angle in radians and c is the velocity of sound.

For 180° incidence the relative phase position of P_1 and P_2 is inverted and

the latter leads the former by the same angle ϕ .

The pressure P_2 acts through the acoustical network developing a pressure P_3 in the chamber g . The net effective pressure upon the diaphragm and hence upon the crystal, is the vector difference between P_1 and P_3 . Through proper selection of constants of the acoustical network it is possible to attain a condition whereby at all important frequencies P_3 is of the same magnitude as P_2 but lags it by the angle ϕ given in Eq. (1).

The manner in which unidirectional action is attained may be shown conveniently by reference to vector diagrams of Fig. 2. Fig. 2a represents the front or 0° incidence of sound. P_1 leads P_2 by the angle ϕ , and P_3 lags P_2 by the same angle. Therefore P_1 and P_3 are displaced by an angle 2ϕ . Subtraction of P_3 from P_1 gives the resultant pressure R which acts upon the piezoelectric crystal.

Figure 2b represents the phase position of sound pressures for the rear or 180° incidence of sound. For this incidence P_2 lags P_1 by the angle ϕ , and since P_3 also lags P_2 by the same angle, P_1 and P_3 are in phase and the subtraction of the latter from the former

gives a resultant net diaphragm pressure equal to zero. The microphone will not, therefore, produce electrical output for sound waves arriving from the rear.

It has been tacitly assumed that P_1 and P_2 have the same magnitude. This assumption is valid if the wavelength of sound is several times as great as the dimensions of the instrument, which in the above microphone is true up to approximately 2500 cycles per second. At higher frequencies the described pressure relationship does not hold, but diffraction effects tend to give a relatively low sensitivity for sounds arriving from the rear. Through careful design of the external case housing the microphone unit, unidirectional action is maintained at all the important frequencies of the sound spectrum, with an average front-to-back discrimination of approximately 15 db.

Equation (1) indicates that the phase angle ϕ is proportional to frequency, and an examination of the vector diagram of Fig. 2a will show that this causes the resultant pressure upon the crystal to increase with frequency. Electrical compensation is provided in the microphone to achieve a smooth wide-range front-side response.

Reprinted by permission from ELECTRONICS, February, 1939

Sensitive at Front! Dead at Rear!
Solves Feedback, Room and Background Noise, Reverberation Problems

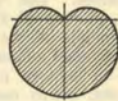

9 out of 10 P. A. Systems need this Uni-Directional **UNIPLEX**

BECAUSE . . . the UNIPLEX stops unwanted sounds—picks up sound only from the front—eliminates feedback, audience and background noise in theatres, night clubs, auditoriums, schools, churches, and similarly difficult acoustic locations! ★ And because it incorporates the exclusive Shure "Uniphase" principle, the Model 730A UNIPLEX is the *lowest cost* true uni-directional microphone. It provides *excellent high quality reproduction* from 30 to 10,000 cycles at the front—but is "dead" at rear. It simplifies the microphone placement problem—improves sound quality—makes possible a satisfactory P.A. installation where poor acoustic conditions did not permit it before. ★ And with its new, ultra-modern streamline design and rich satin chrome finish, it has plenty of eye-value, too. Comes equipped with the new Shure built-in Cable Connector and 25 ft. of special hum-free Super-Shielded cable with plug attached.

Model 730A UNIPLEX Uni-Directional Crystal Microphone. **\$29.50**
List Price

The Uniplex does every sound pickup job better—Try it Today!

List Price after March 20, \$32.50. BUY NOW and SAVE!
(Higher costs have made it necessary to readjust this list price)



(Shure Patent Pending)

SHURE BROTHERS • 225 W. HURON ST. • CHICAGO, U. S. A. • CABLE: SHUREMICRO
DESIGNERS AND MANUFACTURERS OF MICROPHONES AND ACOUSTIC DEVICES

"Sound Systems Sound Better with Shure Microphones"

Printed in U.S.A.

SHURE BROTHERS
Microphone Headquarters



225 WEST HURON STREET • CHICAGO • U.S.A.
TELEPHONE DELAWARE 8383 • CABLE: SHUREMICRO

HERE'S ADVANCE NEWS

March 11, 1939

ABOUT THE NEW SHURE
"UNIDYNE" AND "ROCKET"
DYNAMIC MICROPHONES

Nothing on the market like them! They're new, advanced in principle and performance -- important contributions from "Microphone Headquarters".

These new Shure Dynamic Microphones are backed by scientific laboratory tests, by extensive field checks under all sorts of conditions, and by years of specialized experience in the design and manufacture of better microphones.

The "UNIDYNE" continues Shure leadership in the "directional" field. It's an exclusive, patented microphone incorporating the "Uniphase" principle which has been so successful in the Shure "Uniplex" crystal microphone. Truly the "UNIDYNE" is the deluxe dynamic microphone -- the only high quality uni-directional dynamic microphone at such low cost!

The "ROCKET" is a basically-new moving conductor type microphone -- popularly priced -- ideal for general applications. Has unusually good frequency response -- will stand up under the toughest service conditions out-of-doors and in. In fact, it provides practically every feature you've looked for in a quality general-purpose dynamic.

The attention of the Sound World will soon be focused on these new Shure Dynamic Microphones. Our general promotional campaign begins in April -- Get ready for it now. The suggested Catalog Copy enclosed gives you the whole story. Electros are available by return mail for use in any literature or catalogs which you may be preparing.

Advance orders are being accepted now, to be filled in rotation. "ROCKETS" available for delivery after April 1st. "UNIDYNES" shortly thereafter.



Shure "UNIDYNE"



Shure "ROCKET"



Very truly yours,

SHURE BROTHERS
"Microphone Headquarters"

S. N. Shure

DISTRICT SALES OFFICES • UNITED STATES: BOSTON • BUFFALO • CLEVELAND • DALLAS • DENVER • DETROIT
KANSAS CITY • LOS ANGELES • LOUISVILLE • MINNEAPOLIS • NEW ORLEANS • NEW YORK • PHILADELPHIA
PITTSBURGH • ST. LOUIS • SAN FRANCISCO • SEATTLE • WASHINGTON, D.C. • CANADA: TORONTO • WINNIPEG

Shure Dealer Bulletin introducing the Unidyne, 1939

And the SHURE "Unidyne" is the Only Dynamic that Gives You All This at Such Low Cost!

- TRUE UNI-DIRECTIONAL PICKUP
- STOPS FEEDBACK
- ENABLES PERFORMER TO STAND AWAY FROM MICROPHONE
- PERMITS INCREASED VOLUME AND COVERAGE
- PERMITS CLOSE PLACEMENT OF MICROPHONE AND LOUD SPEAKERS
- MARVELOUS REPRODUCTION



Shure Patents Pending

New SHURE "UNIDYNE" Uni-Directional Dynamic

Very latest in dynamic microphone design—the first high-quality low-cost moving-coil type dynamic with true cardioid unidirectional characteristics. Eliminates feedback, audience and background noise—greatly reduces reverberation pickup. Employs the exclusive Shure "uniphase" principle. Gives smooth wide-range reproduction from 40 to 10,000 cycles over a wide angle at the front, yet is dead (down 12-15 db) at the rear. Solves many troublesome sound pickup problems in public address, recording and broadcasting. Permissible line length practically unlimited with low impedance models. Rugged, shock-proof construction with specially-suspended, double-wind-screened moving-coil system. Practically unaffected by heat and humidity—ideal for severe outdoor as well as indoor service. Ultra-modern streamlined design finished in beautiful satin chrome. Head tilts through full 90-degree angle. Built-in cable connector. Special locking microphone plug attached to cable. 5/8"-27 thread for stand mounting. Case dimensions: 4 3/4" high; 3 1/4" wide; 3 1/2" deep. Net weight, less cable, 2 1/2 lbs. Shipping weight, 4 1/4 lbs.

Model 55A. Low impedance model for 35-50 ohm circuits. Furnished with 25-foot two-conductor shielded cable. Output level: 86 db below 1 volt per bar open circuit, or approximately 62 db below 6 milliwatts for 10 bar signal. Permissible cable length practically unlimited. Code: Rudar.

List Price: **\$42.50**

Model 55B. Low impedance model for 200-250 ohm circuits. Includes internal high-quality transformer. Furnished with 25-foot two-conductor shielded cable. Output level: 77 db below 1 volt per bar open circuit, or approximately 62 db below 6 milliwatts for 10 bar signal. Permissible cable length practically unlimited. Code: Rudat. List Price: **\$45**

Model 55C. High impedance model. May be used with any crystal microphone amplifier or other amplifier with input impedance of 100,000 ohms or more. Includes internal high-quality transformer. Furnished with 25-foot single-conductor shielded cable. (Somewhat longer cable lengths may be used with some loss of high frequency response.) Output level: 58 db below 1 volt per bar. Code: Rudas. List Price: **\$45**

(Shure Patents Pending)

The invention of the "Uniphase" principle by Shure Engineers makes possible this "Unidyne" cardioid true uni-directional dynamic; and it's doing wonders for Sound Engineers today in high quality Public Address, Broadcasting and Recording.

Order the "Unidyne" — now! Try it on the toughest sound job. You'll get the surprise of your life!

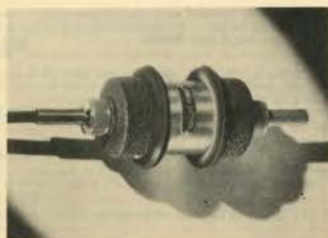

Printed in U.S.A.

SHURE A86A CABLE-TYPE TRANSFORMER

Matches 35-50 and 200-250 ohm low impedance dynamic microphones (or lines) to high-impedance amplifier input. Makes it convenient to run long microphone lines from low impedance microphone to high impedance amplifier.

The A86A Transformer may be located in any convenient place within 25 ft. of the amplifier. The small, compact, sturdy tubular case is magnetically shielded. Cast end-covers are removable for access to the terminals. Compression fittings seal-in microphone and amplifier cables. Clamp fitting is provided for permanent installation. Complete with 7 ft. single-conductor cable for connection to amplifier, which may be extended to a recommended maximum length of approximately 25 feet. Finished in chrome and morocco gray. Case diameter, 1 5/8"; length (not including compression fittings), 2 7/8". Net weight, 1 lb.; Shpg. wt., 1 1/4 lbs.

Code: Rudeb. List Price: **\$8.50**

Copyright 1939, Shure Brothers

**SHURE BROTHERS • 225 W. HURON ST. • CHICAGO, U. S. A. • CABLE: SHUREMICRO
DESIGNERS AND MANUFACTURERS OF MICROPHONES AND ACOUSTIC DEVICES**

Catalog page featuring the Unidyne, 1939

Goodbye Feedback

SHURE
True Cardioid **UNI-DIRECTIONAL MICROPHONES**

"UNIPLEX"

"UNIDYNE"

REMARKABLE INVENTION
CHANGES MICROPHONE
TECHNIQUE

The advertisement features a red background. At the top, the words "Goodbye Feedback" are written in a white, cursive font with musical notes scattered around. Below this, a black and white illustration of a woman with blonde hair styled in a bun is shown singing into a microphone. To the right of the woman, a black rounded rectangle contains two microphone models: the "UNIPLEX" model at the top and the "UNIDYNE" model at the bottom. Below the "UNIDYNE" model is a small heart-shaped logo. At the bottom of the advertisement, the word "SHURE" is written in a bold, sans-serif font, followed by "True Cardioid" in a cursive font and "UNI-DIRECTIONAL MICROPHONES" in a bold, sans-serif font.

Advertising flyer for the Unidyne, ca. 1940



They're way up there in Alaska—and so are Shure Microphones. The Shure Unidyne above receives the broadcasts of these boys over WVCQ—the soldiers' own station.



Somewhere in the tropics, this sergeant operates his two-way radio. Note the Shure Military Carbon Microphone at right.



The capable T-17 is inspected by Brig. General W. S. Rumbaugh and Brig. General P. B. Rogers in an M.P. car in London.



Over Madang, N. G., this gunner blasts away. The Headphones are as necessary as his gun.



French Admiral accepts Destroyer Escort for Fighting French Navy — over two Shure Unidynes.

The Unidyne in action during World War II (photos from Shure Shots Associate publication)

Unidyne History - Internal Windscreen Material

Cloth (including silk, cotton, nylon, polyester, and others) has been used in Shure microphones since the 1930s. Cloth was, and is, chosen based on availability, price, durability, color, ability to handle adhesives, and acoustical characteristics. Documents from Shure Engineering provided the following details about the cloth.

1944

Cloth- "Ninon" or "Chiffonese #101"
Colors - Black (Shure part #10A28A); White (10A28B); Azure Blue (10A28C)
Acoustical resistance of material shall be 1 ohm (maximum) per square centimeter.

1947

Cloth- "Organza" cloth supplied by Vogue Fabric, Evanston, Illinois.
Shure engineers would visit the Vogue Fabric store with a device, a manometer, that measured acoustical resistance.
New colors - Maroon (10A28D); Victoria Blue (10A28E)

1948

This cloth shall consist of 80 threads per square inch.
The space between adjacent parallel threads must not exceed 0.011 inch.

1955

New colors - Red (10A28F); Brown (10A28G)

1958

New color - Gray (10A28H)

1972

New colors - Any Solid Color (10A28J); Royal Blue (10A28K); Dark Blue (10A28L); Any Solid Dark Color (10A28M); Navy (10A28N)





Model 55S

1951 to 1961 - Cloth color was Victoria Blue (10A28E)
1961 - Cloth color changed to Black (10A28A)

Model 556S

1954 - Cloth color was Maroon (10A28D) or Red (10A28F); both colors were used based on availability.

COLOR SHADES

The blue color from the 1940s was similar to Pantone color 2748 U (U = uncoated)	
The maroon color from the 1940s was similar to Pantone color 222 U.....	
The blue color from the 1950s was similar to Pantone color 2756 U.....	
The red color from the 1950s was similar to Pantone color 187 U.....	
The dark blue color from the 1970s was similar to Pantone color 2768 U.....	

Note: The color name would typically change when a new material/supplier replaced the previous material/supplier.



Credits and Acknowledgements

Authors: Michael Pettersen, Greg DeTogne

Editors: Michael Pettersen, Julie Snyder, Laura Suchocki

Research: Michael Pettersen, Julie Snyder, Family of Benjamin Bauer

Layout and Design: Erik Watson

Project Management: Laura Suchocki

Photography and Images: Stuart Van Dorn, Shure Archives, Oldsmobile Division of General Motors

Copyright 2014, Shure Incorporated. All Rights Reserved

Shure Incorporated
5800 West Touhy Avenue
Niles, Illinois USA 60714
www.shure.com



SHURE[®]