

BIG KNOB Operation Guide

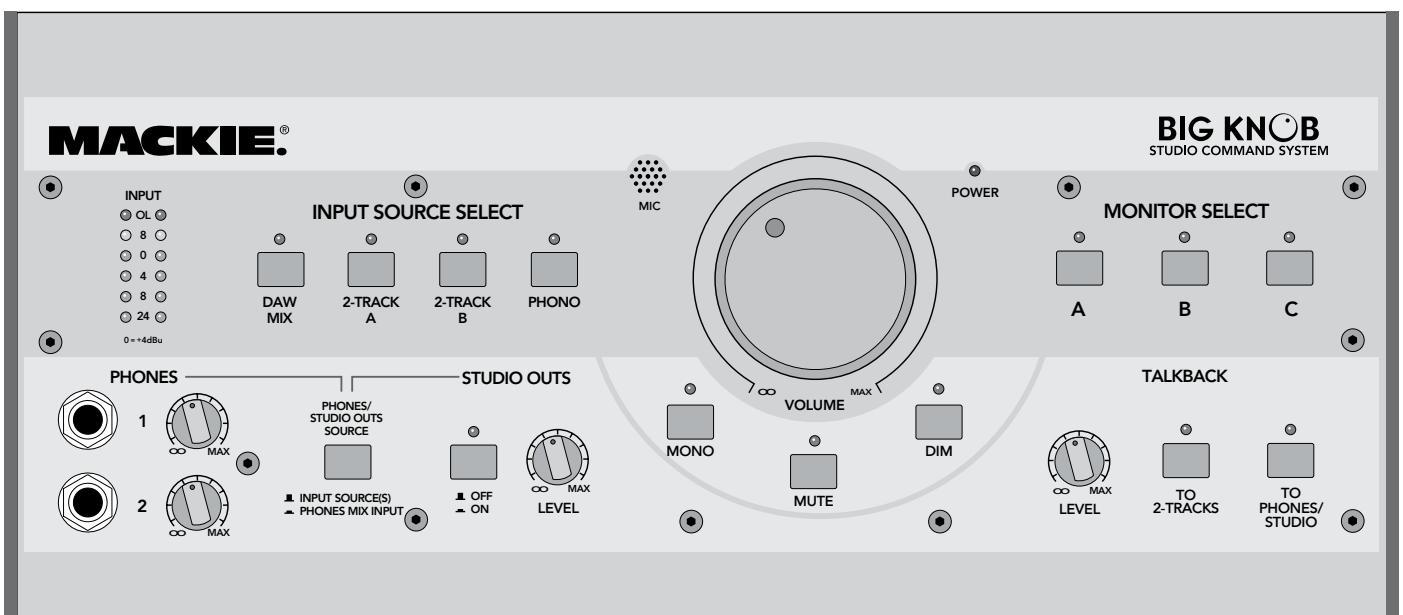

STUDIO COMMAND SYSTEM

MACKIE.[®]

Important Safety Instructions

1. Read these instructions.
2. Keep these instructions.
3. Heed all warnings.
4. Follow all instructions.
5. Do not use this apparatus near water.
6. Clean only with dry cloth.
7. Do not block any ventilation openings. Install in accordance with the manufacturer's instructions.
8. Do not install near any heat sources such as radiators, heat registers, stoves, or other apparatus (including amplifiers) that produce heat.
9. Do not defeat the safety purpose of the polarized or grounding-type plug. A polarized plug has two blades with one wider than the other. A grounding-type plug has two blades and a third grounding prong. The wide blade or the third prong are provided for your safety. If the provided plug does not fit into your outlet, consult an electrician for replacement of the obsolete outlet.
10. Protect the power cord from being walked on or pinched particularly at plugs, convenience receptacles, and the point where they exit from the apparatus.
11. Only use attachments/accessories specified by the manufacturer.
12. Use only with a cart, stand, tripod, bracket, or table specified by the manufacturer, or sold with the apparatus. When a cart is used, use caution when moving the cart/apparatus combination to avoid injury from tip-over.
13. Unplug this apparatus during lightning storms or when unused for long periods of time.
14. Refer all servicing to qualified service personnel. Servicing is required when the apparatus has been damaged in any way, such as power-supply cord or plug is damaged, liquid has been spilled or objects have fallen into the apparatus, the apparatus has been exposed to rain or moisture, does not operate normally, or has been dropped.
15. The MAINS plug or an appliance coupler is used as the disconnect device, so the disconnect device shall remain readily operable.
16. This apparatus has been equipped with a rocker-style AC mains power switch. This switch is located on the rear panel and should remain readily accessible to the user.
17. This apparatus does not exceed the Class A/Class B (whichever is applicable) limits for radio noise emissions from digital apparatus as set out in the radio interference regulations of the Canadian Department of Communications.

ATTENTION — *Le présent appareil numérique n'émet pas de bruits radioélectriques dépassant les limites applicables aux appareils numériques de class A/de class B (selon le cas) prescrites dans le règlement sur le brouillage radioélectrique édicté par les ministere des communications du Canada.*

18. Exposure to extremely high noise levels may cause permanent hearing loss. Individuals vary considerably in susceptibility to noise-induced hearing loss, but nearly everyone will lose some hearing if exposed to sufficiently intense noise for a period of time. The U.S. Government's Occupational Safety and Health Administration (OSHA) has specified the permissible noise level exposures shown in the following chart.

According to OSHA, any exposure in excess of these permissible limits could result in some hearing loss. To ensure against potentially dangerous exposure to high sound pressure levels, it is recommended that all persons exposed to equipment capable of producing high sound pressure levels use hearing protectors while the equipment is in operation. Ear plugs or protectors in the ear canals or over the ears must be worn when operating the equipment in order to prevent permanent hearing loss if exposure is in excess of the limits set forth here.

Duration Per Day In Hours	Sound Level dBA, Slow Response	Typical Example
8	90	Duo in small club
6	92	
4	95	Subway Train
3	97	
2	100	Very loud classical music
1.5	102	
1	105	Tami screaming at Adrian about deadlines
0.5	110	
0.25 or less	115	Loudest parts at a rock concert

PORTABLE CART WARNING



Carts and stands - The Component should be used only with a cart or stand that is recommended by the manufacturer. A Component and cart combination should be moved with care. Quick stops, excessive force, and uneven surfaces may cause the Component and cart combination to overturn.

CAUTION AVIS

RISK OF ELECTRIC SHOCK
DO NOT OPEN

RISQUE DE CHOC ELECTRIQUE
NE PAS OUVRIR

CAUTION: TO REDUCE THE RISK OF ELECTRIC SHOCK DO NOT REMOVE COVER (OR BACK) NO USER-SERVICEABLE PARTS INSIDE REFER SERVICING TO QUALIFIED PERSONNEL

ATTENTION: POUR EVITER LES RISQUES DE CHOC ELECTRIQUE, NE PAS ENLEVER LE COUVERCLE. AUCUN ENTRETIEN DE PIECES INTERIEURES PAR L'USAGER. CONFIER L'ENTRETIEN AU PERSONNEL QUALIFIE.

AVIS: POUR EVITER LES RISQUES D'INCENDIE OU D'ELECTROCUTION, N'EXPOSEZ PAS CET ARTICLE A LA PLUIE OU A L'HUMIDITE

The lightning flash with arrowhead symbol within an equilateral triangle is intended to alert the user to the presence of uninsulated "dangerous voltage" within the product's enclosure, that may be of sufficient magnitude to constitute a risk of electric shock to persons.

Le symbole éclair avec point de flèche à l'intérieur d'un triangle équilatéral est utilisé pour alerter l'utilisateur de la présence à l'intérieur du coffret de "voltage dangereux" non isolé d'ampleur suffisante pour constituer un risque d'électrocution.

The exclamation point within an equilateral triangle is intended to alert the user of the presence of important operating and maintenance (servicing) instructions in the literature accompanying the appliance.

Le point d'exclamation à l'intérieur d'un triangle équilatéral est employé pour alerter les utilisateurs de la présence d'instructions importantes pour le fonctionnement et l'entretien (service) dans le livret d'instruction accompagnant l'appareil.

WARNING — To reduce the risk of fire or electric shock, do not expose this apparatus to rain or moisture.



Correct disposal of this product. This symbol indicates that this product should not be disposed of with your household waste, according to the WEEE Directive (2002/96/EC) and your national law. This product should be handed over to an authorized collection site for recycling waste electrical and electronic equipment (WEEE). Improper handling of this type of waste could have a possible negative impact on the environment and human health due to potentially hazardous substances that are generally associated with WEEE. At the same time, your cooperation in the correct disposal of this product will contribute to the effective usage of natural resources. For more information about where you can drop off your waste equipment for recycling, please contact your local city office, waste authority, or your household waste disposal service.

Table of Contents

Introduction.....4

Getting Started4

 Zero the Controls 4

 Connections..... 4

 Set the Levels5

Hookup 6

Big Knob Features7

 Front Panel7

 Rear Panel..... 9

Appendix A: Service Information..... 13

 Warranty Service..... 13

 Troubleshooting 13

 Repair14

Appendix B: Connections 15

 XLR Connectors 15

 1/4" TRS Phone Plugs and Jacks 15

 1/4" TS Phone Plugs and Jacks 15

 RCA Plugs and Jacks 15

 Footswitch Plug and Jack 15

Appendix C: Technical Info 16

 Big Knob Specifications 16

 Big Knob Block Diagram.....18

Big Knob Limited Warranty 19

Please write your serial number here for future reference (i.e., insurance claims, tech support, return authorization, etc.)

Purchased at:

Date of purchase:

Don't forget to visit our website at www.mackie.com for more information about this and other Mackie products.



Introduction

Thank you for choosing the Mackie Big Knob, your signal routing and monitoring solution for your DAW-based studio. Big Knob provides a control room matrix and the basic features of an expensive mixer, but tailored for the requirements of your DAW (Digital Audio Workstation) environment. These features include selecting up to four separate stereo input sources, monitoring through three different speakers for A/B/C comparisons, providing a separate headphone mix and a studio output for the talent, and a built-in talkback mic for slate-to-tape and headphone cueing. In other words, it gives you everything you need from a mixer, without the stuff you don't need!

Another important feature you've come to expect from Mackie is pristine sound quality, and Big Knob is no exception. This is studio-quality gear, and we made sure the audio signal suffers no degradation by passing through Big Knob. You can connect this baby between your expensive DAW and your *really* expensive studio monitors with no reservations. Big Knob will pass the test!

Big Knob is part of the growing family of Mackie computer recording products. Visit our website (www.mackie.com) to learn more about these products and the solutions to your audio and recording needs that Mackie has to offer, or pick up a catalog at your nearest Mackie dealer.

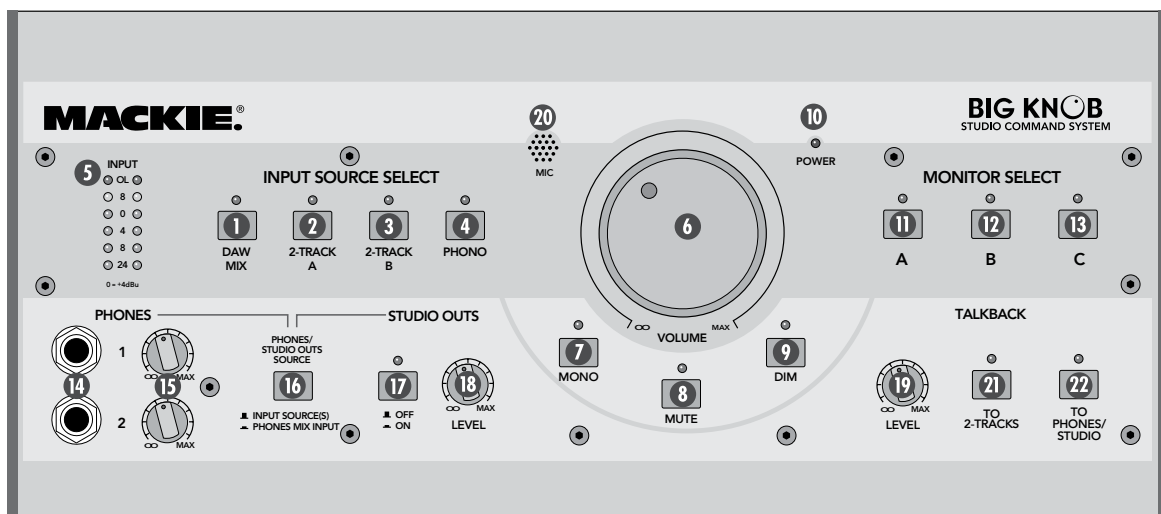

Getting Started

The following steps will help you set up your Big Knob and get the levels adjusted correctly. Once you have made the connections and adjustments, refer to the Features section for more in-depth information about each input, output, switch, and control knob.



Most of the inputs and outputs on Big Knob have either a trim control or a level switch labeled -10 dB and $+4$ dB. This actually comes from two standard operating levels that have evolved in the audio industry:

-10 dBV consumer level and $+4$ dBu professional level. Most consumer equipment with RCA connectors operate at the -10 dBV level, while most professional equipment with 1/4-inch phone jacks or XLR connectors operate at the $+4$ dBu level. As you might expect, the $+4$ dBu level is higher (louder) than the -10 dBV level, so it is important to match the input and output levels of Big Knob to the equipment you have connected to it. For a Big Knob input, the -10 dB setting accepts a smaller signal and provides more gain than the $+4$ dB setting. For a Big Knob output, the -10 dB setting produces a smaller signal than the $+4$ dB setting.

Zero the Controls

1. Turn off the POWER switch (5) on the rear panel.
2. On the front panel, turn the Big VOLUME Knob (6) and all the LEVEL controls all the way down (counterclockwise).
3. Set all the switches to the up position (front and rear panels).
4. On the rear panel, turn all the trim controls all the way down (counterclockwise).

Connections

1. Connect the supplied detachable power cord to the AC socket (54) on the rear panel of Big Knob. Set the AC SELECT switch (56) to the correct position that corresponds to the AC voltage you are using (100-120V or 220-240V).

For Monitoring:

2. Connect the audio outputs (stereo mix) from your DAW's audio interface to the two DAW MIX (29) input jacks on the rear panel of Big Knob.

- Connect the MONITOR A output jacks **38** on the rear panel of Big Knob to a pair of active studio monitors (or the inputs of an amplifier that is powering a pair of passive studio monitors). These will be located at your mixing position. If you know whether the inputs to the active studio monitors (or amplifier) accept a -10 dBV (consumer) or $+4$ dBu input level, set the trim control **39** above the MONITOR A output jacks to the appropriate position. Otherwise, leave it at the -10 dBV position for now. You can connect additional speakers to the MONITOR B **40** and MONITOR C **42** output jacks so you can hear your mix through different types of speakers.
- If you have a separate studio for recording, connect the STUDIO OUTS **52** to a pair of active studio monitors (or the inputs of an amplifier that is powering a pair of passive studio monitors). These will be located in studio for the talent. Set the trim control **53** above the STUDIO OUTS output jacks to the appropriate position, or leave it at the -10 dBV position if you're not sure.
- If you have a headphone distribution amplifier for monitoring while recording, connect the PHONES AMP **50** output jacks to the inputs of the headphone amp. Set the $+4/-10$ level switch **51** above the PHONES AMP output jacks to the appropriate position, or leave it at the -10 position (pushed in) if you're not sure.

For Recording

- Connect the 2-TRACK A **44** outputs to the line-level inputs of any recording device, like a DAT or cassette recorder. This allows you to record from your DAW to the recorder. Set the $+4/-10$ level switch **45** above the 2-TRACK A output jacks to the appropriate position, or leave it at the -10 position (pushed in) if you're not sure.
- Connect the line-level outputs from the DAT or cassette recorder to the 2-TRACK A **23** inputs.
- Connect the DAW **48** output jacks on the rear panel of Big Knob to the stereo inputs of your DAW's audio interface. This allows you to record from the 2-TRACK recorder back to your DAW. Set the $+4/-10$ level switch **49** above the DAW output jacks to the appropriate position, or leave it at the -10 position (pushed in) if you're not sure.

Set the Levels

- With everything off, turn on Big Knob's POWER **55** switch first.
- Turn on all other external power amplifiers, active speakers, and headphone amplifiers.
- Start playback on your DAW and play something you've already recorded (or a demo track). You want to be able to listen to it over the monitor speakers connected to Big Knob.
- Press the DAW MIX **1** button in the INPUT SOURCE SELECT section on the front panel. The LED above the DAW MIX button should light.
- Press the MONITOR A **11** button in the MONITOR SELECT section on the front panel. The LED above the MONITOR A button should light.
- If you know whether your DAW's audio interface output is at a -10 dBV level (consumer) or a $+4$ dBu level (pro), set the $+4/-10$ level switch **30** for the DAW MIX **29** inputs to the appropriate position. If you don't know, leave it out (in the $+4$ dBu position). We can change it later if we need to.
- Slowly turn up the trim control **31** for the DAW MIX input until you see the meters **5** on the front panel lighting and dancing happily. Adjust the control until the meters are lighting the "0" LED regularly. You want the "+8" LED to light only occasionally, and the "OL" LED to not light at all.
- If you can't adjust the trim control far enough to get the signal level up to the 0 and +5 LEDs on the meter, turn the trim control all the way down, push in the $+4/-10$ level switch for the DAW MIX input, and slowly turn up the trim control again. Now the signal should be strong enough to get the 0 and +5 LEDs to light.
- Slowly turn up the Big Knob VOLUME **6** control. You should begin to hear playback from your DAW through your studio monitor speakers. Adjust the VOLUME control to a comfortable listening level. If it seems like you have to turn up the VOLUME control all the way to hear the monitor speakers, turn down the VOLUME control and check to see if the trim control **39**

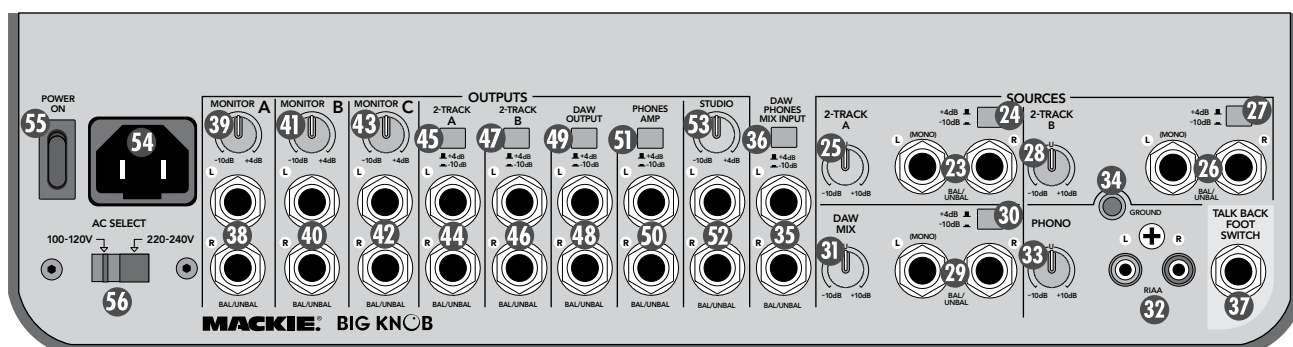

above the MONITOR A **38** output jacks is in the -10 dB position (counterclockwise). If it is, turn the control up to the $+4$ dB position and then turn up the Big Knob VOLUME control. Now it should get louder, faster.

10. If you have monitors connected to the STUDIO OUTS **52**, make sure the PHONES/STUDIO OUTS SOURCE **16** button on the front panel is out, and the STUDIO OUTS ON/OFF **17** button is ON (LED above the button is lit).
11. Slowly turn up the STUDIO OUTS LEVEL **18** control on the front panel. You should begin to hear playback from your DAW through your studio monitor speakers. Adjust the STUDIO OUTS LEVEL control to a comfortable listening level. If it seems like you have to turn up the LEVEL control all the way to hear the studio monitor speakers, turn down the LEVEL control and check to see if the trim control **53** above the STUDIO OUTS **52** jacks is in the -10 dB position (counterclockwise). If it is, turn the control up to the $+4$ dB position and then turn up the LEVEL control. Now it should get louder, faster.
12. If you have a headphone distribution amplifier connected to the PHONES AMP **50** outputs, you should be able to turn up the volume for each headphone connected to the headphone amplifier and hear playback from the DAW. If it seems like you're not getting enough volume from the headphone amplifier, turn down all the headphone volume controls on the headphone ampli-

fier and check to see if the $+4/-10$ level switch **51** above the PHONES AMP **50** output jacks is in the -10 dB position (pushed in). If it is, switch it to the $+4$ position and then turn up the headphone volume control on the headphone amplifier. Now it should get louder, faster.

13. You can connect a pair of headphones to one of the two PHONES **14** jacks on the front panel of Big Knob. Slowly turn up its associated LEVEL **15** control to a comfortable listening level.
 14. If you want to record from the DAT or cassette player to your DAW, start playback on the DAT or cassette connected to Big Knob.
- CAUTION:** See "A Cautionary Note" on the next page to avoid creating a feedback loop through the 2-TRACK inputs and outputs.
15. Push in the 2-TRACK A **2** button in the INPUT SOURCE SELECT section on the front panel and turn off the DAW MIX button. Slowly turn up the trim control **25** for the 2-TRACK A input until you see the meters **5** on the front panel light. Adjust the control until the meters are lighting the "0" LED regularly. You want the "+8" LED to light only occasionally, and the "OL" LED to not light at all.
 16. Make sure the inputs to the DAW are selected for recording. Start recording and the playback from the 2-TRACK A input to Big Knob should be recording in the DAW application. If it seems like you're not getting enough volume from the 2-TRACK playback, check to see if the $+4/-10$ level switch **49** above the DAW **43** output jacks is in the -10 dB position (pushed in). If it is, switch it to the $+4$ position. This will provide a stronger signal to send to your DAW.

Hookup

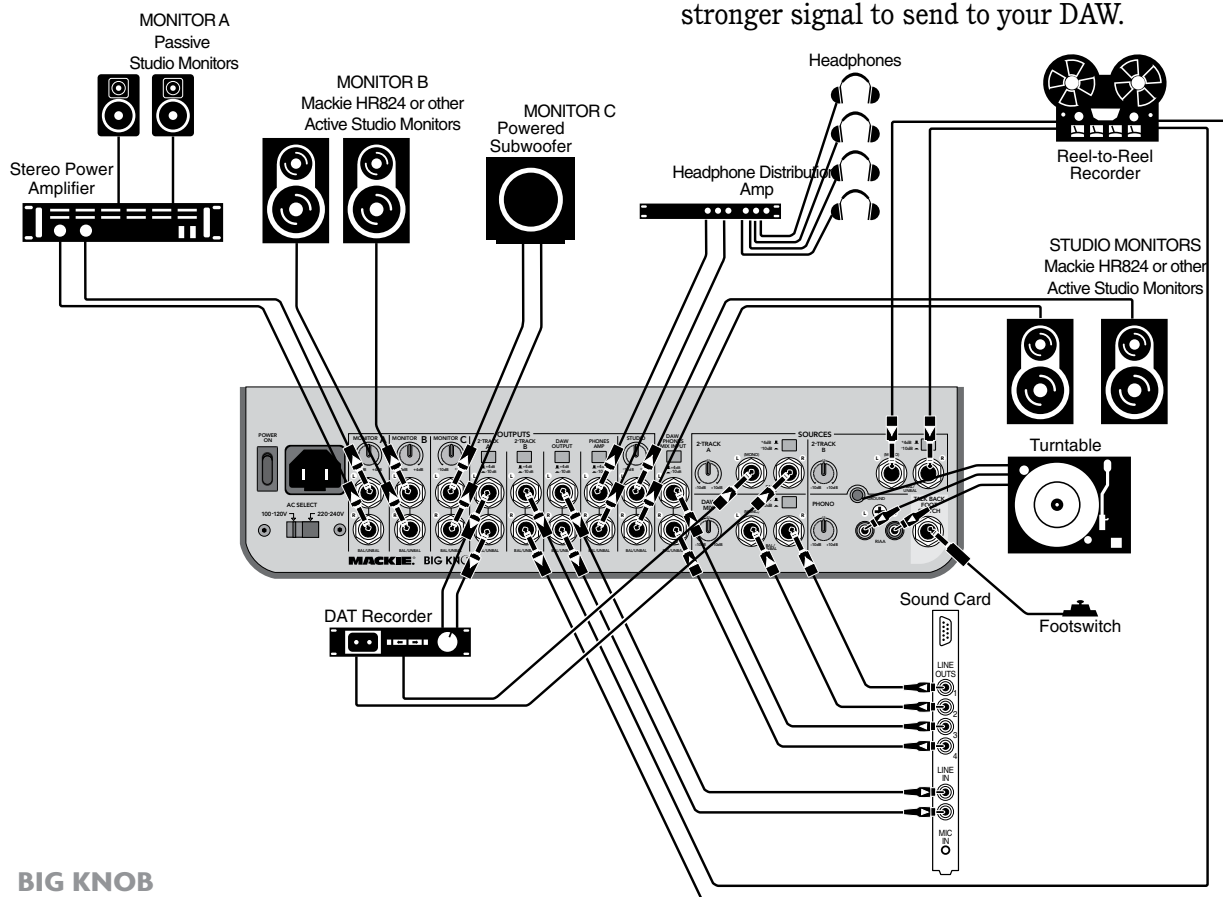

Big Knob Features

Front Panel

INPUT SOURCE SELECT Section

These buttons turn on or off the four input signals connected to Big Knob. Any combination of the four inputs can be turned on at the same time, as indicated by the red LEDs above the buttons.

When selected, these input sources are routed to the MONITOR A, B, and C stereo outputs, the 2-TRACK A and 2-TRACK B stereo outputs, the DAW stereo outputs and, when the PHONES/STUDIO OUTS SOURCE button is out (INPUT SOURCES), to the PHONES AMP and STUDIO OUTS stereo outputs, and to the PHONES 1 and 2 outputs on the front panel.



A Cautionary Note: When you have a 2-track recording device connected to both the inputs and the outputs on Big Knob, you run the risk of creating a feedback loop. If the recording device is in record, record pause, or input monitor mode, the signal can go from the 2-TRACK outputs through the recording device and back into the 2-TRACK inputs, creating a circular loop that results in a terrible howl.

You must remember to turn off the 2-TRACK INPUT SOURCE SELECT button when recording to your 2-track recorder!

1 DAW MIX

Turns on the signals connected to the DAW MIX stereo inputs.

2 2-TRACK A

Turns on the signals connected to the 2-TRACK A stereo inputs.

3 2-TRACK B

Turns on the signals connected to the 2-TRACK B stereo inputs.

4 PHONO

Turns on the signals connected to the PHONO stereo inputs.

5 INPUT METERS

These six segment meters show the signal level of the currently selected stereo source(es). The scale of the six segments of the meter is: -24, -8, -4, 0, +8, and OL (Overload), where "0" is referenced to +4 dBu.

6 VOLUME

This Big Knob adjusts the volume of the selected input source going to the selected speaker outputs (MONITOR A, B, and C). The VOLUME knob ONLY affects the volume level of the monitor outputs (A, B, and C). It does not affect the volume of the signal going to other outputs, such as the headphone outputs, 2-TRACK outputs, or DAW outputs.

The VOLUME knob ranges from OFF (∞) to +10 dB of gain (MAX).

7 MONO

Pressing this button combines the stereo signal into a monophonic signal at the MONITOR A, B, and C outputs. The left and right input signals are summed and the mono signal is output at both the left and right outputs. This lets you check for phase problems in the stereo signal when played over a monophonic system.

8 MUTE

Press this button to mute the signal going to the MONITOR A, B, and C outputs.

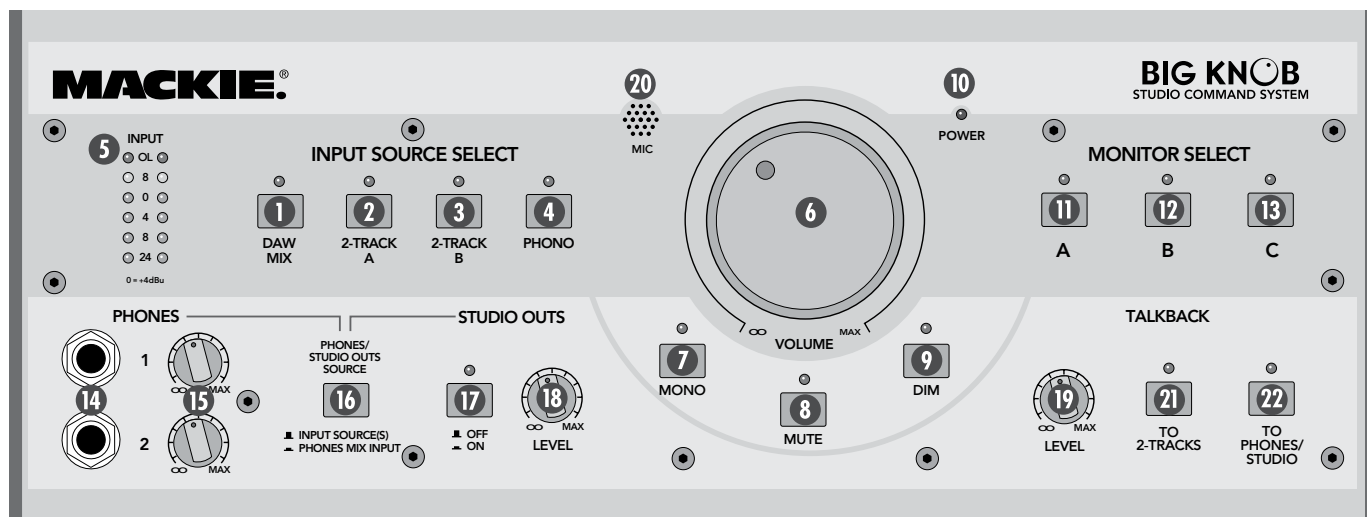

9 DIM

Pressing this button turns down the signal going to the MONITOR A, B, and C outputs by 20 dB. This lets you turn down the speakers to converse without affecting the speaker level you have set.

Note: Like the Big Knob VOLUME control, the MONO, MUTE, and DIM buttons ONLY affect the MONITOR A, B, and C outputs. These buttons have no effect on the currently selected source(s) as they are routed to the other various outputs.

10 POWER LED

This LED lights when the POWER switch is turned on and Big Knob is receiving AC power. It lets you know that Big Knob is turned on, even if no other buttons are pressed that would light up their associated red LED.

MONITOR SELECT**11 A**

Press this button to route the currently selected input source(s) to the MONITOR A **38** output jacks.

12 B

Press this button to route the currently selected input source(s) to the MONITOR B **40** output jacks.

13 C

Press this button to route the currently selected input source(s) to the MONITOR C **42** output jacks.



Application Note: You can have one, two, or all three MONITOR outputs turned on at the same time. You could connect MONITOR B to a pair of full-range speakers and MONITOR C to a subwoofer. Use the MONITOR C button as a “subwoofer IN/OUT” switch to compare the sound with and without the subwoofer.

14 PHONES 1 and 2

These 1/4-inch TRS connectors output an amplified stereo signal of either the DAW PHONES MIX INPUT **35** or the INPUT SOURCES **23 26 29 32**, depending on the position of the PHONES/STUDIO OUT SOURCE **16** switch described below.

15 PHONES 1 and 2 Level Control

These rotary knobs control the volume of the stereo signal at the PHONES 1 and 2 headphone connectors. The same signal appears at both headphone outputs, but the volumes are adjusted independently with these level controls.



Note: Turn down the PHONES LEVEL controls before plugging in your headphones. The PHONES outputs are designed to drive headphones to a very loud level, so it is best to start with the LEVEL controls turned all the way down and then turn them up SLOWLY to a comfortable listening level. In fact, *starting right now*, get in the habit of turning down the PHONES LEVEL controls when you are done using your headphones so you don't plug them in later and accidentally blow out your ears!

16 PHONES/STUDIO OUT SOURCE Button

This button affects the stereo signal going to:

- Both headphone outputs (PHONES 1 and 2) **14** on the front panel
- The PHONES AMP **50** output on the rear panel
- The STUDIO OUTS **52** on the rear panel

When INPUT SOURCE(S) is selected (up), the above outputs are fed the signal from the INPUT SOURCE SELECT buttons. This is the same signal that goes to the MONITOR A, B, and C outputs. In this position, the recording engineer and the talent can listen to the same mix (the MONITOR outs and STUDIO/PHONES outs have the same signal).

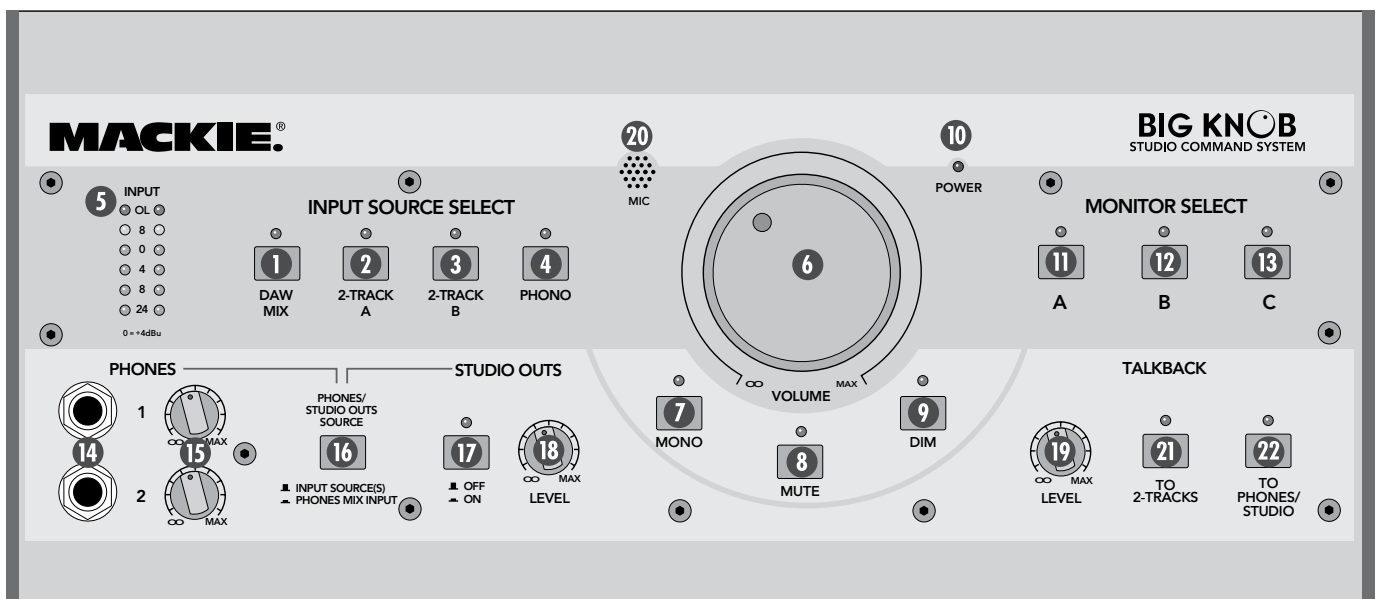

When the button is down (PHONES MIX INPUT), the STUDIO/PHONES outputs are fed the signal from the DAW PHONES MIX INPUT 35 jacks on the rear panel. In this position, the recording engineer listens to the “real” mix coming from the DAW (DAW MIX INPUT), but the talent can listen to an alternate and specialized mix coming from the DAW (DAW PHONES MIX INPUT).



Many DAW applications provide at least four outputs through their associated I/O hardware. Two outputs can provide the main mix, which is connected to the DAW MIX INPUTs on Big Knob and selected for monitoring with the DAW MIX INPUT SOURCE SELECT button. The engineer can create a separate headphone mix for the talent in the DAW application by using a stereo aux send routed to another pair of outputs, which is connected to the DAW PHONES MIX INPUT on Big Knob and routed to the STUDIO/PHONES outputs with the PHONES/STUDIO OUT SOURCE button.

17 STUDIO OUTS ON/OFF

This button turns the signal path on and off going to the STUDIO OUTS 52 jacks on the rear panel. When the button is pushed in (ON), the red LED above the button lights and the signal appears at the STUDIO OUTS.

18 STUDIO OUTS LEVEL Control

This controls the level at the STUDIO OUTS 52 on the rear panel.

19 TALKBACK LEVEL

This knob controls the level of the preamp for the internal omni-directional talkback mic, as it is routed either to the DAW 48 and 2-TRACK A 44 and B 46 outputs (when the TO 2-TRACKS 21 button is pressed) or to the PHONES/STUDIO bus (when the TO PHONES/STUDIO 22 button is pressed). The gain of the TALKBACK LEVEL control ranges from Off (∞) to +10 dB when turned all the way up.

20 Internal Talkback MIC

This omni-directional microphone is located right in Big Knob’s front panel, just to the left of the Big VOLUME 6 Knob. The microphone is activated when one of the two TALKBACK assign buttons is pressed.

21 TO 2-TRACKS

Pressing this momentary button illuminates the red LED above it, activates the internal talkback MIC, and sends its signal to the:

- 2-TRACK A 44 output connectors
- 2-TRACK B 46 output connectors
- DAW 48 output connectors

22 TO PHONES/STUDIO

Pressing this momentary button illuminates the red LED above the button, activates the internal talkback MIC, and sends its signal to the:

- PHONES 1 and 2 14 headphone outputs on the front panel
- PHONES AMP 50 outputs on the rear panel
- STUDIO OUTS 52 on the rear panel

The TALKBACK TO PHONES/STUDIO button routes the talkback signal to all of these outputs no matter how the PHONES/STUDIO OUTS SOURCE 16 selector button is set. This means that all the headphones and studio outputs will hear the talkback signal whether they are getting program material from the INPUT SOURCE(S) or the PHONES MIX INPUT 35.

Unlike all of the other buttons, the TALKBACK TO PHONES/STUDIO and TALKBACK TO 2-TRACKS buttons are momentary, and only activate the talkback mic as long as they are physically pressed.

Note: Both talkback buttons can be pressed at the same time to route the talkback mic to the 2-TRACK outputs and the PHONES/STUDIO outputs.

If the TALKBACK FOOTSWITCH 37 jack on the rear panel is activated by an external footswitch, it is the equivalent of pressing both talkback buttons at once.

Rear Panel

SOURCES

The following section describes the connectors that are used for various sources feeding into Big Knob.

23 2-TRACK A Inputs

These stereo 1/4-inch balanced/unbalanced inputs are fed by the outputs of the first external 2-track recorder. If a mono signal is plugged into the LEFT input only, it is automatically routed to both LEFT and RIGHT inputs.

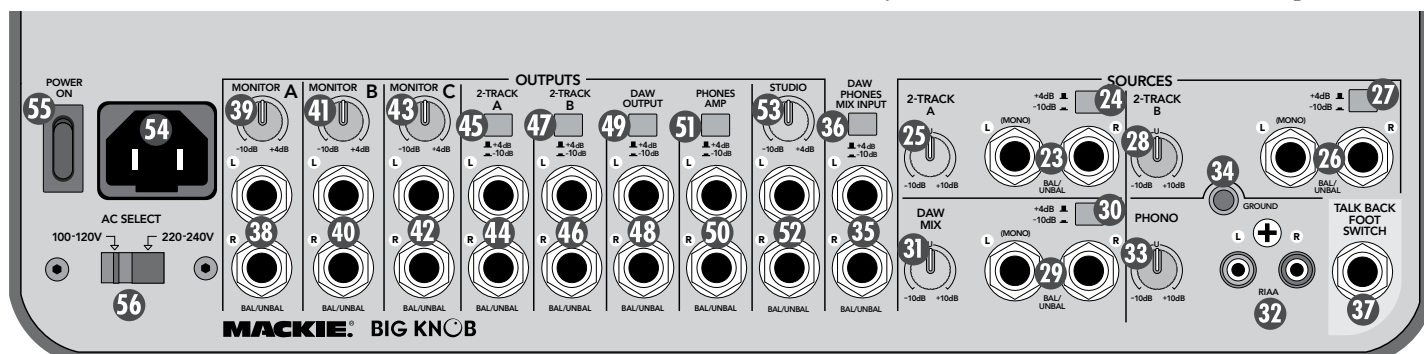

24 2-TRACK A Level Switch

This two-position switch sets the input level of the 2-TRACK A inputs to either +4 dB (balanced input) or -10 dB (unbalanced input). Use the +4 dB setting for professional equipment operating at the +4 dBu standard, and use the -10 dB setting for consumer equipment operating at the -10 dBV standard.

25 2-TRACK A Trim Control

This control adjusts the input sensitivity of the incoming 2-TRACK A signal by ± 10 dB (unity at center detent). This allows for precise level matching between the various incoming 2-track sources, which often do not have output level controls of their own.

26 2-TRACK B Inputs

These stereo 1/4-inch balanced/unbalanced inputs are fed by the outputs of the second external 2-track recorder. If a mono signal is plugged into the LEFT input only, it is automatically routed to both LEFT and RIGHT inputs.

27 2-TRACK B Level Switch

This two-position switch sets the input level of the 2-TRACK B inputs to either +4 dB (balanced) or -10 dB (unbalanced). Use the +4 dB setting for professional equipment operating at the +4 dBu standard, and use the -10 dB setting for consumer equipment operating at the -10 dBV standard.

28 2-TRACK B Trim Control

This control adjusts the input sensitivity of the incoming 2-TRACK B signal by ± 10 dB (unity at center detent). This allows for precise level matching between the various incoming 2-track sources, which often do not have output level controls of their own.

29 DAW MIX

These stereo 1/4-inch balanced/unbalanced inputs are fed by the master mix output of the DAW, usually the DAW outputs 1-2. If a mono signal is plugged into the LEFT input only, it is automatically routed to both LEFT and RIGHT inputs.

30 DAW MIX Level Switch

This two-position switch sets the input level of the DAW MIX inputs to either +4 dB (balanced input) or -10 dB (unbalanced input). Use the +4 dB setting

for professional equipment operating at the +4 dBu standard, and use the -10 dB setting for consumer equipment operating at the -10 dBV standard.

31 DAW MIX Trim Control

This control adjusts the input sensitivity of the incoming DAW MIX signal by ± 10 dB (unity at center detent). This allows you to precisely fine tune the incoming level of the DAW MIX input so it matches the signal level of other incoming 2-track sources.

32 PHONO

These stereo RCA unbalanced inputs are fed by the outputs of a turntable with a moving-magnet cartridge (MM). These inputs have a built-in precision RIAA preamplifier that provides the equalization and gain required for a phono-level signal to return it to a proper line-level signal.

This allows you to playback vinyl records and dub them to a 2-track recorder, as well as send the phono signal to the input of the DAW for archiving/restoration/CD burning.

Note: Two RCA shorting plugs are provided, which should be plugged into the PHONO inputs when they are not being used. This terminates the inputs and reduces the noise floor should you accidentally push in the PHONO INPUT SOURCE SELECT button.

33 PHONO Trim Control

This trim control adjusts the input sensitivity of the incoming PHONO signal by ± 10 dB. This allows you to precisely fine tune the incoming level of the PHONO input so it matches the signal level of other incoming 2-track sources.

The PHONO input does not need a +4/-10 level switch since a phonograph is always at a consumer signal level, unlike tape decks and soundcards, which could be -10 or +4, depending on the model.

34 PHONO Grounding Lug (GND)

This small grounding lug allows you to connect the grounding wire from an attached turntable. This prevents ground loops and hum from showing up in the phono source's audio signal.

35 DAW PHONES MIX INPUT

These stereo 1/4-inch balanced/unbalanced inputs allow connection of a second stereo mix from the DAW for a custom headphone mix.

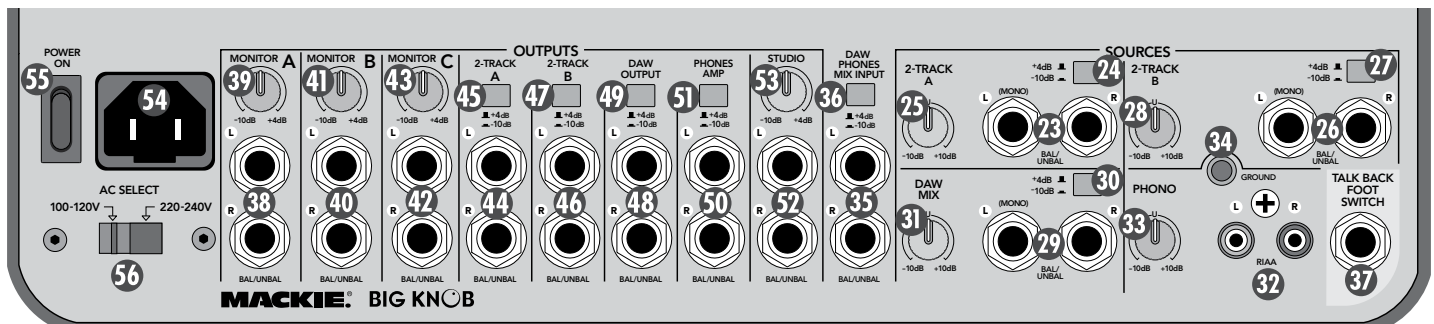

For example, the DAW's 1-2 outputs can send the main mix to the DAW MIX 29 inputs on Big Knob, and the DAW's 3-4 outputs can send a custom headphone mix to the DAW PHONES MIX INPUT. You can then use the PHONES/STUDIO OUTS SOURCE 16 button to select the mix for the PHONES 14 50 and STUDIO OUTS 52.

36 DAW PHONES MIX Level Switch

This two-position switch sets the input level of the DAW PHONES MIX inputs to either +4 dB (balanced input) or -10 dB (unbalanced input). Use the +4 dB setting for professional equipment or soundcards operating at the +4 dBu standard, and use the -10 dB setting for consumer equipment or soundcards operating at the -10 dBV standard.

37 TALKBACK FOOTSWITCH

This 1/4-inch TS connector accepts a standard momentary footswitch (normally open), or a momentary handheld switch such as the Switchcraft ED900. This allows a producer standing at a remote location to activate the talkback circuit and communicate with recording talent.

When an external switch is connected and goes from its "normally open" position to its "momentary closed" position, the front panel TALKBACK TO 2-TRACKS 21 and TO PHONES/STUDIO 22 buttons both activate, their LEDs illuminate, and the talkback circuit is activated just as if someone had physically pressed these two buttons. See "Appendix B: Connections" for a wiring diagram of the footswitch connection.

OUTPUTS

The following outputs are fed by the "control room bus." This is the signal path fed from the inputs currently selected with the INPUT SOURCE SELECT buttons and routed through the Big VOLUME 6 Knob.

38 MONITOR A OUTPUTS

These stereo 1/4-inch balanced/unbalanced outputs connect to the first set of external speakers. You can connect these outputs to self-powered speakers, or to a power amplifier driving passive speakers.

39 MONITOR A Trim Control

This trim control adjusts the sensitivity of the MONITOR A output signal. Use the +4 dB setting when connecting to balanced inputs on professional equipment operating at the +4 dBu standard, and use the -10 dB setting when connecting to unbalanced inputs on consumer equipment operating at the -10 dBV standard. The trim control can be adjusted to any setting between the +4 and -10 positions if necessary to precisely match the levels among the MONITOR A, B, and C outputs.

40 MONITOR B OUTPUTS

Works as described above for the Monitor A path.

41 MONITOR B Trim Control

Works as described above for the Monitor A path.

42 MONITOR C OUTPUTS

Works as described above for the Monitor A path.

43 MONITOR C Trim Control

Works as described above for the Monitor A path.

Note: The overall level of the MONITOR A, B, and C OUTPUTS is controlled by the Big VOLUME 6 Knob on the front panel.

44 2-TRACK A OUTPUTS

These stereo 1/4-inch balanced/unbalanced outputs connect to the inputs of the first external 2-track recorder. This could be a DAT deck, cassette deck, reel-to-reel recorder, etc. The signal at these outputs is whatever source is selected with the INPUT SOURCE SELECT buttons on the front panel.

45 2-TRACK A Level Switch

This two-position switch sets the level of the 2-TRACK A outputs to either +4 dB (out) or -10 dB (pushed in). Use the +4 dB setting when connecting to balanced inputs on professional equipment operating at the +4 dBu standard, and use the -10 dB setting when connecting to unbalanced inputs on consumer equipment operating at the -10 dBV standard.

46 2-TRACK B OUTPUTS

Works as described above for the 2-TRACK A OUTPUTS.

47 2-TRACK B Level Switch

Works as described above for the 2-TRACK A level switch.

48 DAW OUTPUTS

These stereo 1/4-inch balanced/unbalanced outputs connect to a pair of inputs on the DAW audio interface.

49 DAW Level Switch

This two-position switch sets the level of the DAW outputs to either +4 dB (out) or -10 dB (pushed in). Use the +4 dB setting when connecting to balanced inputs on professional equipment or soundcards operating at the +4 dBu standard, and use the -10 dB setting when connecting to unbalanced inputs on consumer equipment or soundcards operating at the -10 dBV standard.

By allowing balanced or unbalanced operation, as well as -10 or +4 operation, on an individual basis, you can connect any combination of professional or consumer 2-track recorders and DAW soundcards that you have available in your arsenal of audio recording equipment.



Note: All three of the above outputs (2-TRACK A, 2-TRACK B, and DAW) produce the signal selected by the INPUT SOURCE SELECT buttons on the front panel. These outputs require no variable level output controls (aside from the +4/-10 switches), since the connected 2-track recorders and DAW inputs typically have their own variable input level controls.

PHONES AMP and STUDIO OUT

The PHONES AMP and STUDIO OUTS have the option of being fed signal by the currently selected INPUT SOURCE SELECT buttons (thus mirroring the mix being heard by the engineer) or the signal connected to the DAW PHONES MIX INPUT connectors (thus providing a separate unique monitoring mix for the talent).

This allows the engineer to listen to his or her own master mix in the control room, while allowing the talent to listen to a customized headphone mix at the same time through the PHONES 1 or 2 outputs on the front panel or through an external headphone amp connected to the PHONES AMP OUTPUT on the rear panel, as well as the studio monitor outs (STUDIO OUTS). The choice of which stereo signal (current source or headphone mix input) is heard is determined by the PHONES/STUDIO OUTS SOURCE 16 select button on the front panel.

50 PHONES AMP OUTPUTS

Connect these stereo 1/4-inch balanced/unbalanced connectors to an external multi-headphone amplifier. This allows you to connect multiple sets of headphones for the talent. The PHONES AMP OUTPUT level is not affected by the Big VOLUME 6 Knob or the headphone level controls on the front panel. The headphone amplifier should have its own individual volume controls for the headphones.

51 PHONES AMP Level Switch

This two-position switch sets the level of the PHONES AMP outputs to either +4 dB (out) or -10 dB (pushed in). Use the +4 dB setting when connecting to balanced inputs on professional equipment operating at the +4 dBu standard, and use the -10 dB setting when connecting to unbalanced inputs on consumer equipment operating at the -10 dBV standard.

52 STUDIO OUTS

Connect these stereo 1/4-inch balanced/unbalanced connectors to a pair of active monitors (or to an amplifier and passive monitors) in the studio performance space. This allows the performers to hear playback without having to use headphones, and allows the control room engineer to communicate to the performers through the talkback system. The STUDIO OUTS level is controlled by the STUDIO OUTS LEVEL 18 control on the front panel.

53 STUDIO OUTS Trim Control

This trim control adjusts the sensitivity of the STUDIO OUTS signal. Use the +4 dB setting when connecting to balanced inputs on professional equipment operating at the +4 dBu standard, and use the -10 dB setting when connecting to unbalanced inputs on consumer equipment operating at the -10 dBV standard. Although the trim control is typically set to one side or the other, it can be adjusted to any setting between the +4 and -10 positions if necessary.

44 AC Socket

Connect the included detachable power cord to this AC socket (2-prong IEC connector) on the rear panel. Make sure the AC SELECT switch is set to the correct AC voltage (see 56 AC SELECT Switch).

55 POWER Switch

Push this switch up to turn the Big Knob on. Press the bottom of this switch to put the Big Knob into standby mode. It will not function, but the circuits are still live. To remove AC power, either turn off the AC mains supply, or unplug the power cord from the speaker and the AC mains supply.

56 AC SELECT Switch

Set this switch to the 100-120V position for 100 VAC and 120 VAC power, and to the 220-240V position for 220 VAC and 240 VAC power.

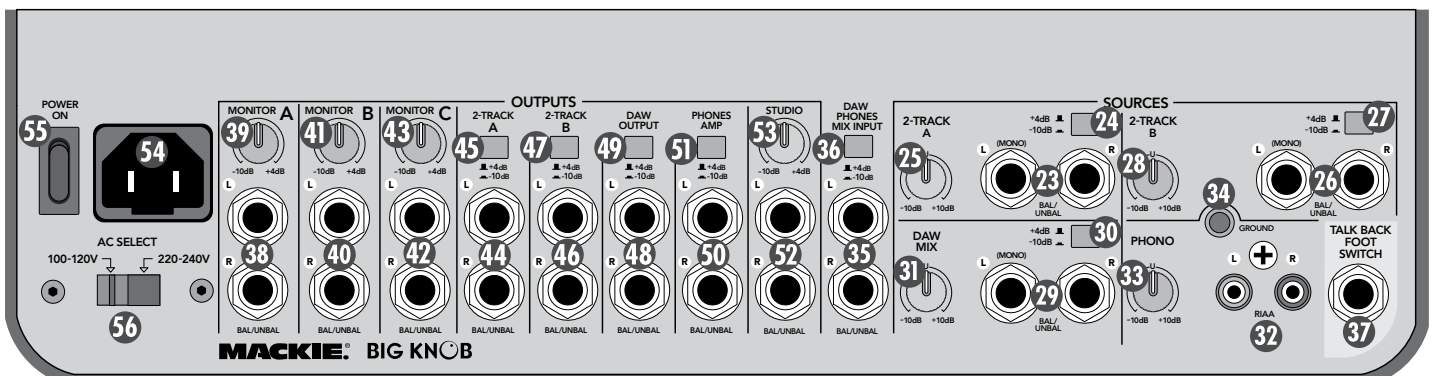

Appendix A: Service Information

Warranty Service

If you think your Mackie product has a problem, please check out the following troubleshooting tips and do your best to confirm the problem. Visit the Support section of our website (www.mackie.com/support) where you will find lots of useful information such as FAQs and other documentation. You may find the answer to the problem without having to send your Mackie product away.

Troubleshooting

No Power

- Our favorite question: Is it plugged in?
- Make sure the power cord is securely seated in the IEC socket **51** and plugged all the way into the AC outlet.
- Make sure the AC outlet is live (check with a tester or lamp).
- Is the POWER **55** switch on? Make sure the POWER switch on the rear panel is in the ON position (up).
- Is the POWER LED **10** on the front panel illuminated? If not, make sure the AC outlet is live. If so, refer to “No Sound” below.
- Are all the lights out in your building? If so, contact your local power company to get power restored.
- If the POWER LED is not illuminated, and you are certain that the AC outlet is live, it will be necessary to have Big Knob serviced. *There are no user serviceable parts inside.* Refer to “Repair” at the end of this section to find out how to proceed.

No Sound

- Is the POWER LED **10** on the front panel illuminated? If not, refer to “No Power” above.
- Is the correct INPUT SOURCE SELECT button selected? Make sure the LED above the INPUT SOURCE SELECT button is lit.
- Is the signal source turned up? Make sure the signal level from the selected input source is high enough to light up some of the INPUT meter LEDs on Big Knob’s front panel.
- Make sure the trim control and level switch for the selected input are set correctly.

- If there is no sound in the PHONES **14** **50** or STUDIO **52** outputs:
 - Make sure the PHONES/STUDIO OUTS SOURCE **16** button on the front panel is up (INPUT SOURCES selected).
 - Make sure the PHONES **15** or STUDIO **18** Level control is turned up.
 - Make sure the STUDIO OUTS ON/OFF button is ON.
- If there is no sound in the MONITOR OUTPUTS **38** **40** **42** :
 - Make sure the correct MONITOR SELECT button is pushed in and the trim control for the MONITOR OUTPUT is set correctly.
 - Make sure the cable connecting the MONITOR OUTPUT to the active speaker or power amplifier isn’t defective and the amplifier/speaker combination is working correctly.

Bad Sound

- Is the input connector plugged completely into the jack?
- Is it loud and distorted? Make sure the trim control and level switch for the selected input is set correctly. Reduce the signal level on the input source if possible.
- If possible, listen to the signal with headphones plugged into the input source device. If it sounds bad there, it’s not Big Knob causing the problem.
- Make sure the trim control for the MONITOR OUTPUT is set correctly and not overdriving the input stage of the active speaker or amplifier to which it is connected.

Noise/Hum

- If a turntable is connected to the PHONO **32** inputs on Big Knob, make sure the ground wire from the turntable is connected to the GND **34** terminal on Big Knob.
- If a turntable is *not* connected to the PHONO inputs, make sure the PHONO INPUT SOURCE SELECT button is not pushed in. Also make sure the RCA shorting plugs are connected to the PHONO inputs when not being used.
- Check the signal cables between the input sources and Big Knob. Disconnect them one by one. When the noise goes away, you’ll know which input source is causing the problem.
- Sometimes it helps to plug all the audio equipment into the same AC circuit so they share a common ground.

Repair

For warranty service, refer to the warranty information on page 19.

Non-warranty service for Mackie products is available at a factory-authorized service center. To locate your nearest service center, visit www.mackie.com, click "Support" and select "Locate a Service Center." Service for Mackie products living outside the United States can be obtained through local dealers or distributors.

If you do not have access to our website, you can call our Tech Support department at 1-800-898-3211, Monday-Friday, normal business hours, Pacific Time, to explain the problem. Tech Support will tell you where the nearest factory-authorized service center is located in your area.

Need Help?

**You can reach a technical support representative
Monday through Friday
normal business hours, PST at:**

1-800-898-3211

**After hours, visit www.mackie.com and click Support,
or email us at: techmail@mackie.com**

Appendix B: Connections

1/4" TRS Phone Plugs and Jacks

"TRS" stands for Tip-Ring-Sleeve, the three connection points available on a stereo 1/4" or balanced phone jack or plug. TRS jacks and plugs are used for balanced signals and stereo headphones:

Balanced Mono

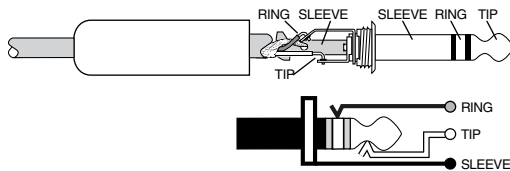

1/4" TRS Balanced Mono Wiring:
 Sleeve = Shield
 Tip = Hot (+)
 Ring = Cold (-)

Stereo Headphones

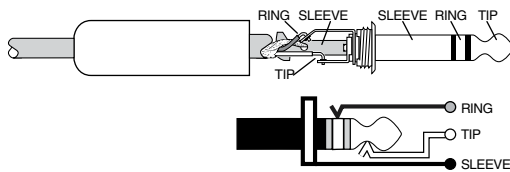

1/4" TRS Stereo Unbalanced Wiring:
 Sleeve = Shield
 Tip = Left
 Ring = Right

1/4" TS Phone Plugs and Jacks

"TS" stands for Tip-Sleeve, the two connection points available on a mono 1/4" phone jack or plug. They are used for unbalanced signals.

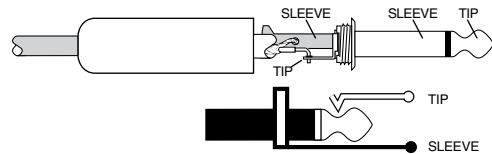

1/4" TS Unbalanced Wiring:
 Sleeve = Shield
 Tip = Hot (+)

RCA Plugs and Jacks

RCA-type plugs (also known as phono plugs) and jacks are often used in home stereo and video equipment and in many other applications. They are unbalanced and electrically equivalent to a 1/4" TS phone plug.

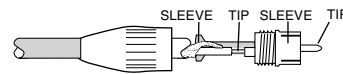

RCA Unbalanced Wiring:
 Sleeve = Shield
 Tip = Hot (+)

Footswitch Plug and Jack

The TALKBACK FOOTSWITCH jack accepts a 1/4" TS plug. Shorting the tip and sleeve together activates the talkback circuit. This is equivalent to pressing the TO 2-TRACKS and TO PHONES/STUDIO buttons in the TALKBACK section.

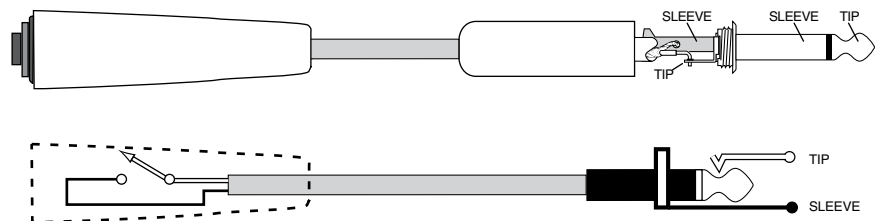

Handheld Switch

Appendix C: Technical Info

Big Knob Specifications

Frequency Response

Line-level Inputs and Outputs
 +0, -1 dB, 10 Hz to 50 kHz
 +0, -3 dB, 5 Hz to 100 kHz
 RIAA Equalization Deviation (Phono Input)
 ± 0.5 dB from 20 Hz to 20 kHz

Distortion (THD & IMD)

Line-level Inputs to Line-level Outputs (unity gain)
 > 0.015%, 20 Hz to 20 kHz @ +4 dBu
 RIAA Input, Nominal Gain
 > 0.015%, 20 Hz to 20 kHz @ +4 dBu

Noise Floor

(20 kHz Bandwidth, +4 dB level setting, 150Ω source)
 Unity Gain, with DAW, 2-Track A, and 2-Track B Assigned
 -86 dBu maximum (all outputs)
 Monitor A, B, and C Outputs, Studio Output, DAW, 2-Track A,
 and 2-Track B Outputs
 -90 dBu typical
 Phono Input (nominal 41.8 dB gain @ 1 kHz, inputs shorted)
 -71 dBu maximum (all outputs)
 Equivalent Input Noise (E.I.N.)
 0.89 μV / -119 dBu maximum

Dynamic Range

Line Inputs
 112 dB minimum
 Phono Input
 93 dB minimum

Common Mode Rejection Ratio

(20 Hz to 20 kHz @ +4 dB level setting)
 34 dB minimum
 40 dB typical

Crosstalk

Adjacent Inputs
 90 dB @ 1 kHz
 Left to Right/Right to Left
 70 dB @ 1 kHz
 Muted/Level Off
 90 dB @ 1 kHz

Trim Control Range

Input Trim Controls (Center Detented)
 ±10 dB
 Output Trim Controls
 -14 dB to 0 dB
 Dim Switch
 0 dB/-20 dB

Rated Input Voltage

Line Inputs (+4 dB Level Setting)
 +4 dBu/+28 dBu (nominal/maximum)
 Line Inputs (-10 dB Level Setting)
 -10 dBu/+14 dBu (nominal/maximum)
 RIAA Input (@ 1 kHz, nominal gain)
 5 mV/79 mV (nominal/maximum)

Rated Output Voltage

All Line-level Outputs (+4dB Level Setting)
 +4 dBu/+22 dBu (nominal/maximum)
 All Line-level Outputs (-10 dB Level Setting)
 -10 dBu/+8 dBu (nominal/maximum)

Maximum Voltage Gain

DAW, 2-Track A, and 2-Track B Input to:
 Monitor A, B, and C Outputs
 34 dB
 DAW, 2-Track A, 2-Track B, and Phones Amp Outputs
 24 dB
 Studio Output
 34 dB
 Phones 1 and 2 Outputs
 34 dB (output loaded @ 100 kΩ)
DAW Phone Mix Input to:
 Phones Amp Outputs
 14 dB
 Studio Output
 24 dB
 Phones 1 and 2 Outputs
 24 dB (output loaded @ 100 kΩ)

Phono Input @ 1 kHz to:

Monitor A, B, and C Outputs
 67.8 dB
 DAW, 2-Track A, 2-Track B, and Phones Amp Outputs
 57.8 dB
 Studio Output
 67.8 dB
 Phones 1 and 2 Outputs
 67.8 dB (output loaded @ 100 kΩ)

Input Impedance

Line Input
 24 kΩ balanced
 12 kΩ unbalanced
 Phono Input
 47 kΩ || 220 pF

Output Impedance

Line Output
 300 Ω balanced
 150 Ω unbalanced
 Headphone Output
 150 Ω

Input VU Meters

6 Segment (0L, +8 dB, 0 dB, -4 dB, -8 dB, -24 dB)

Talkback Section

Automatic Gain Control (AGC) Range
±15 dB

Nominal Output Level
+4 dBu (+4 dB output level setting)

Output Level Range
Off to +10 dB

Nominal Microphone Input Sensitivity
80 dB SPL

AC Power Requirement

U.S. 120 VAC, 60 Hz
Europe 240 VAC, 50 Hz
Japan 100 VAC, 50/60 Hz
Korea 220 VAC, 60 Hz

Power Consumption
25 watts

Physical Dimensions

Height 3.2 in/81 mm (3.5 in/89 mm with Knob)
Width 13.5 in/343 mm
Depth 5.9 in/150 mm
Net Weight 3.5 lb/ 1.6 kg

LOUD Technologies Inc. is always striving to improve our products by incorporating new and improved materials, components, and manufacturing methods. Therefore, we reserve the right to change these specifications at any time without notice.

“Mackie,” “Big Knob,” and the “Running Man” are registered trademarks of LOUD Technologies Inc. All other brand names mentioned are trademarks or registered trademarks of their respective holders, and are hereby acknowledged.

©2004-2009 LOUD Technologies Inc. All Rights Reserved.

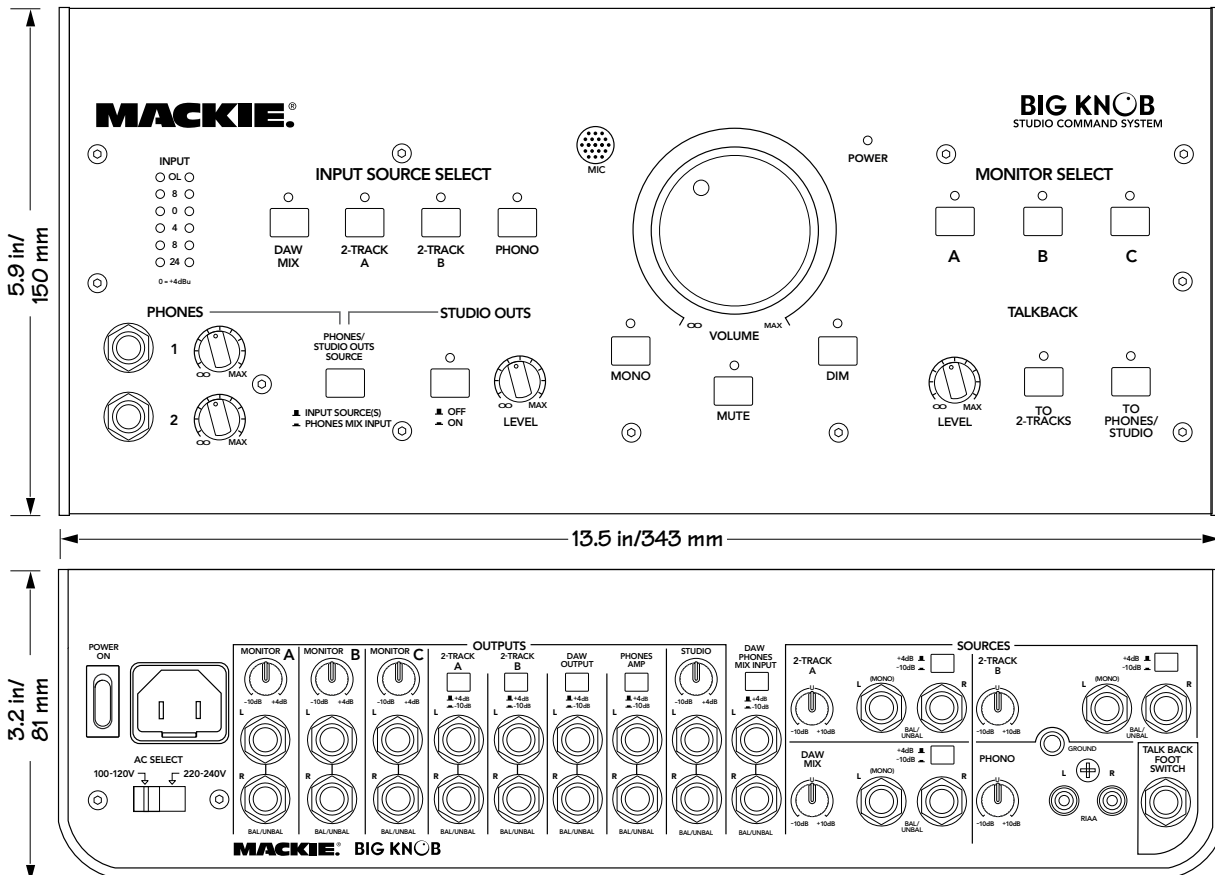

Big Knob Block Diagram

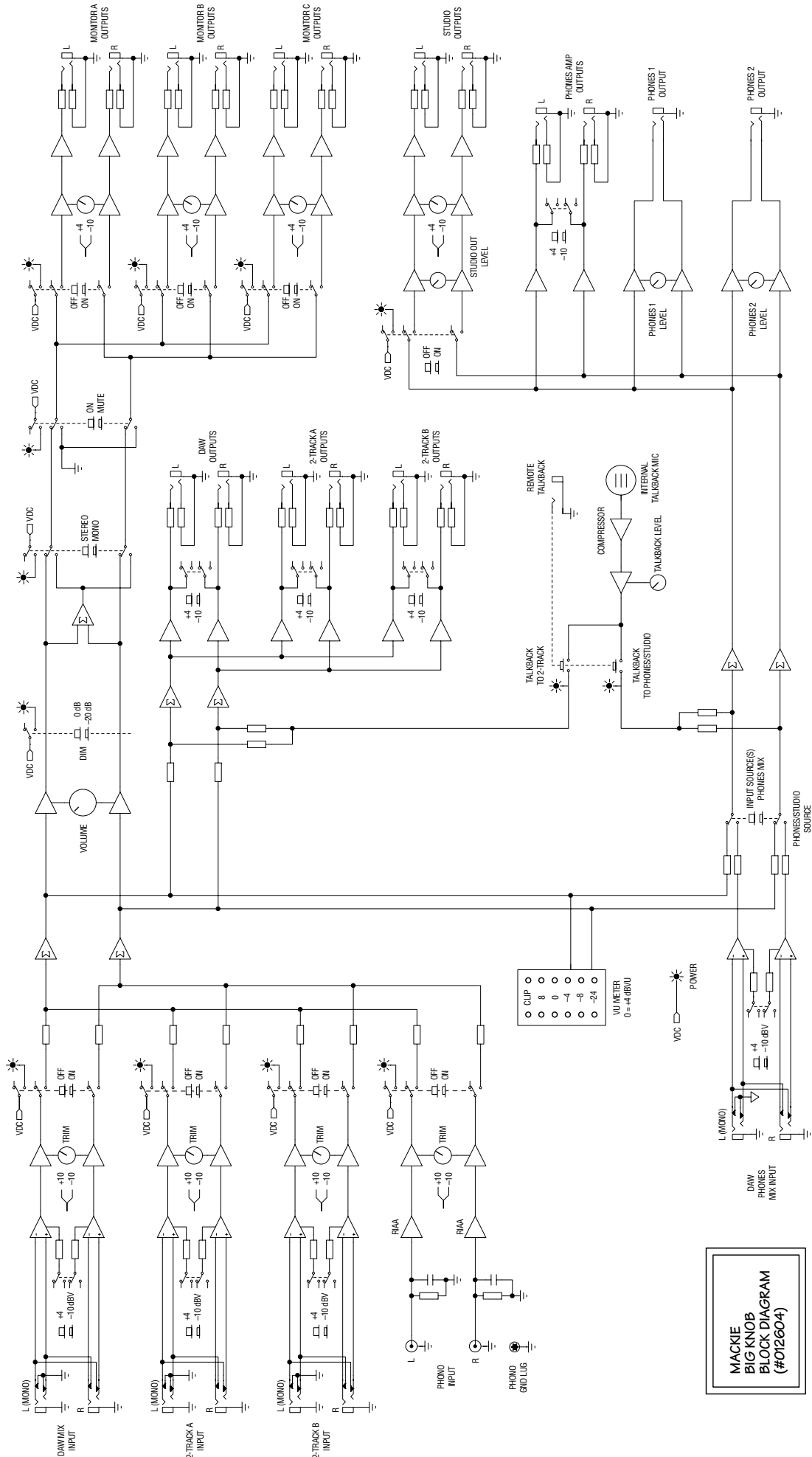

MACKIE
BIG KNOB
BLOCK DIAGRAM
(#012604)

Big Knob Limited Warranty

Please keep your sales receipt in a safe place.

This Limited Product Warranty (“Product Warranty”) is provided by LOUD Technologies Inc. (“LOUD”) and is applicable to products purchased in the United States or Canada through a LOUD-authorized reseller or dealer. The Product Warranty will not extend to anyone other than the original purchaser of the product (hereinafter, “Customer,” “you” or “your”).

For products purchased outside the U.S. or Canada, please visit www.mackie.com/warranty to find contact information for your local distributor, and information on any warranty coverage provided by the distributor in your local market.

LOUD warrants to Customer that the product will be free from defects in materials and workmanship under normal use during the Warranty Period. If the product fails to conform to the warranty then LOUD or its authorized service representative will at its option, either repair or replace any such nonconforming product, provided that Customer gives notice of the noncompliance within the Warranty Period to the Company at: www.mackie.com/support or by calling LOUD technical support at 1.800.898.3211 (toll-free in the U.S. and Canada) during normal business hours Pacific Time, excluding weekends or LOUD holidays. Please retain the original dated sales receipt as evidence of the date of purchase. You will need it to obtain any warranty service.

For full terms and conditions, as well as the specific duration of the Warranty for this product, please visit www.mackie.com/warranty.

The Product Warranty, together with your invoice or receipt, and the terms and conditions located at www.mackie.com/warranty constitutes the entire agreement, and supersedes any and all prior agreements between LOUD and Customer related to the subject matter hereof. No amendment, modification or waiver of any of the provisions of this Product Warranty will be valid unless set forth in a written instrument signed by the party to be bound thereby.

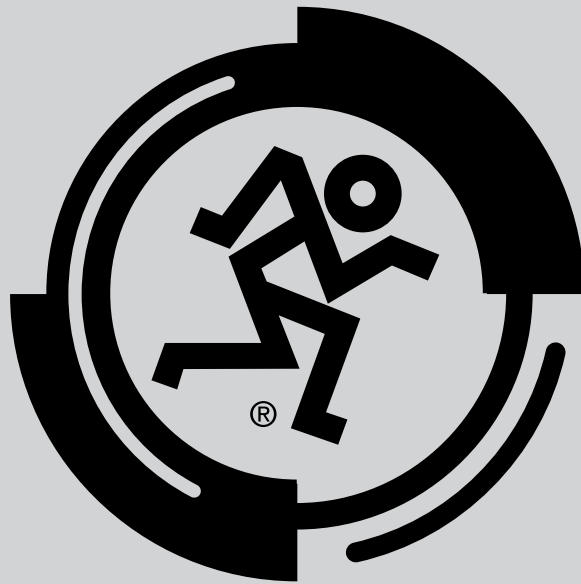

MACKIE®

16220 Wood-Red Road NE • Woodinville, WA 98072 • USA

US and Canada: 800.898.3211

Europe, Asia, Central and South America: 425.487.4333

Middle East and Africa: 31.20.654.4000

Fax: 425.487.4337 • www.mackie.com

E-mail: sales@mackie.com