



IMPORTANT SAFETY INSTRUCTIONS



The lightning flash with an arrowhead symbol within an equilateral triangle is intended to alert the user to the presence of uninsulated "dangerous voltage" within the product's enclosure that may be of sufficient magnitude to constitute a risk of electric shock to persons.

- 1 Read these instructions.
- 2 Keep these instructions.
- 3 Heed all warnings.
- 4 Follow all instructions.
- 5 Do not use this apparatus near water.
- 6 Clean only with dry cloth.
- 7 Do not block any ventilation openings. Install in accordance with the manufacturer's instructions.
- 8 Do not install near any heat sources such as radiators, heat registers, stoves, or other apparatus (including amplifiers) that produce heat.
- 9 Do not defeat the safety purpose of the polarized or grounding-type plug. A polarized plug has two blades with one wider than the other. A grounding type plug has two blades and a third grounding prong. The wide blade or the third prong are provided for your safety. If the provided plug does not fit into your outlet, consult an electrician for replacement of the obsolete outlet.
- 10 Protect the power cord from being walked on or pinched particularly at plugs, convenience receptacles, and the point where they exit from the apparatus.
- 11 Only use attachments/accessories specified by the manufacturer.
- 12  Use only with the cart, stand, tripod, bracket, or table specified by the manufacturer, or sold with the apparatus. When a cart is used, use caution when moving the cart/apparatus combination to avoid injury from tip-over.
- 13 Unplug this apparatus during lightning storms or when unused for long periods of time.
- 14 Refer all servicing to qualified service personnel. Servicing is required when the apparatus has been damaged in any way, such as power-supply cord or plug is damaged, liquid has been spilled or objects have fallen into the apparatus, the apparatus has been exposed to rain or moisture, does not operate normally, or has been dropped.



The exclamation point within an equilateral triangle is intended to alert the user to the presence of important operating and maintenance (servicing) instructions in the literature accompanying the product.

Warning!

- To reduce the risk of fire or electric shock, do not expose this apparatus to rain or moisture and objects filled with liquids, such as vases, should not be placed on this apparatus.
- This apparatus must be earthed.
- Use a three wire grounding type line cord like the one supplied with the product.
- Be advised that different operating voltages require the use of different types of line cord and attachment plugs.
- Check the voltage in your area and use the correct type. See table below:

Voltage	Line plug according to standard
110-125V	UL817 and CSA C22.2 no 42.
220-230V	CEE 7 page VII, SR section 107-2-D1/IEC 83 page C4.
240V	BS 1363 of 1984. Specification for 13A fused plugs and switched and unswitched socket outlets.

- This equipment should be installed near the socket outlet and disconnection of the device should be easily accessible.
- To completely disconnect from AC mains, disconnect the power supply cord from the AC receptacle.
- The mains plug of the power supply shall remain readily operable.
- Do not install in a confined space.
- Do not open the unit – risk of electric shock inside.

Caution:

You are cautioned that any change or modifications not expressly approved in this manual could void your authority to operate this equipment.

Service

- There are no user-serviceable parts inside.
- All service must be performed by qualified personnel.

EMC / EMI & CERTIFICATE OF CONFORMITY

EMC/EMI

This equipment has been tested and found to comply with the limits for a Class B Digital device, pursuant to part 15 of the FCC rules.

These limits are designed to provide reasonable protection against harmful interference in residential installations. This equipment generates, uses and can radiate radio frequency energy and, if not installed and used in accordance with the instructions, may cause harmful interference to radio communications. However, there is no guarantee that interference will not occur in a particular installation. If this equipment does cause harmful interference to radio or television reception, which can be determined by turning the equipment off and on. The user is encouraged to try to correct the interference by one or more of the following measures:

- Reorient or relocate the receiving antenna.
- Increase the separation between the equipment and receiver.
- Connect the equipment into an outlet on a circuit different from that to which the receiver is connected.
- Consult the dealer or an experienced radio/TV technician for help.

For Customers in Canada:

This Class B digital apparatus complies with Canadian ICES-003.

Cet appareil numérique de la classe B est conforme à la norme NMB-003 du Canada.

Certificate of Conformity

TC Electronic A/S, Sindalsvej 34, 8240 Risskov, Denmark, hereby declares on own responsibility that the following product:

NOVA System

- *Effects Processor for electric guitars*

that is covered by this certificate and marked with CE-label conforms with following standards:

EN 60065 (IEC 60065)	Safety requirements for mains operated electronic and related apparatus for household and similar general use
EN 55103-1	Product family standard for audio, video, audio-visual and entertainment lighting control apparatus for professional use. Part 1: Emission.
EN 55103-2	Product family standard for audio, video, audio-visual and entertainment lighting control apparatus for professional use. Part 2: Immunity.

With reference to regulations in following directives:
73/23/EEC, 89/336/EEC

Issued in Risskov, January 2008
Mads Peter Lübeck
Chief Executive Officer

TABLE OF CONTENTS

INTRODUCTION

Safety Instructions	a
EMC/EMI & Certificate of Conformity	b
Table of contents	3
Introduction	5

OPERATION

NOVA System – Front panel	6
Operation	7
NOVA System – Rear panel	9

SETUPS

Basic Setup	10
NOVA System in a an effects loop	11

MENUS

Routing	12
Levels	14
Boost Function	15
Pedals	16
Utility	18
The Tuner	20
MIDI	21
Recall	24
Edit	24
Store	25
Delete	25

EFFECTS

Drive

Overdrive	26
Distortion	26

Compression

Sustaining	27
Percussive	28
Advanced	28

EQ and Noise Gate

EQ	29
Noise Gate	29

Modulation - Mod

Phaser	31
Tremolo	32
Panner	33
Chorus	34
Flanger	35
Vibrato	36

Modulation - Pitch

Detune	37
Whammy	37
Octaver	38
Pitch Shifter	39
Intelligent Pitch Shifter	40

Delay Types

Common Delay Parameters	41
Clean	42
Analog	42
Tape	42
Dynamic	42
PingPong	42
Dual	43
Spillover	43

Reverb Types

Common Reverb Parameters	44
Spring	44
Hall	44
Room	44
Plate	44

APPENDIX

Technical Specifications	46
--------------------------	----

INTRODUCTION

NOVA System - All-in-One Extravaganza

The Audible Choice

NOVA System is the complete, floor-based effects solution for the dedicated guitar player who knows quality when he sees it. Its unique inclusion of an all-analog distortion/overdrive section under preset and expression control makes it the perfect choice whether you want to trim down your rack setup, step up from your pedal patchwork or simply just want the ultimate combination of operational simplicity and audio superiority.

Add to this an array of effects taken straight from the king of floor-based processors; G-System and you have top-notch compression, EQ, noise gate, modulation, pitch, delay and reverb right at your feet. All you need is a guitar and an amp and you're good to go – first class.

Genuine, Analog Drive Circuit

What makes NOVA System so remarkably different is the NDT™ - NOVA Drive Technology - a unique, new drive and distortion circuit that gets you the best of both worlds: World-class analog distortion and overdrive with digital control. This is the real deal – no modeling. While the NDT™ is 100% analog and physically separated from the digital effects, its control potmeters are digital. This way you can tweak, store and recall as many drive settings as you want - you can even hook up an expression pedal and control the amount of distortion in real-time. Its wide gain range covers your every need from light breakup to heavy distortion.

Top-notch Effects

Equipped with TC branded quality effects from delays and reverbs to compressor, EQ and modulation, NOVA System is the obvious all-in-one solution for any guitarist who wants setup simplicity without sacrificing tonal fidelity. All neatly programmable and storable in 60 user presets. Its 30 factory presets give you a demonstration of just what this unit provides; great sound quality and an immense versatility of effects combinations – all designed to get you started right out of the box.

Features

- All-analog overdrive and distortion under preset and expression control.
- 6 effect blocks taken straight from G-System:
 - Compression
 - EQ + Noise Gate
 - Modulation
 - Pitch
 - Delay
 - Reverb
- 30 factory and 60 user presets
- Two footswitch layouts: preset and pedal
- Hi-Z and balanced input + balanced stereo outputs
- Optional G-Switch for added control

The current manual revision number is found at the bottom of page 3.
Latest manual revision can always be downloaded via www.tcelectronic.com.
To seek additional information and support please visit TC Support interactive that also can be accessed via www.tcelectronic.com



OVERVIEW

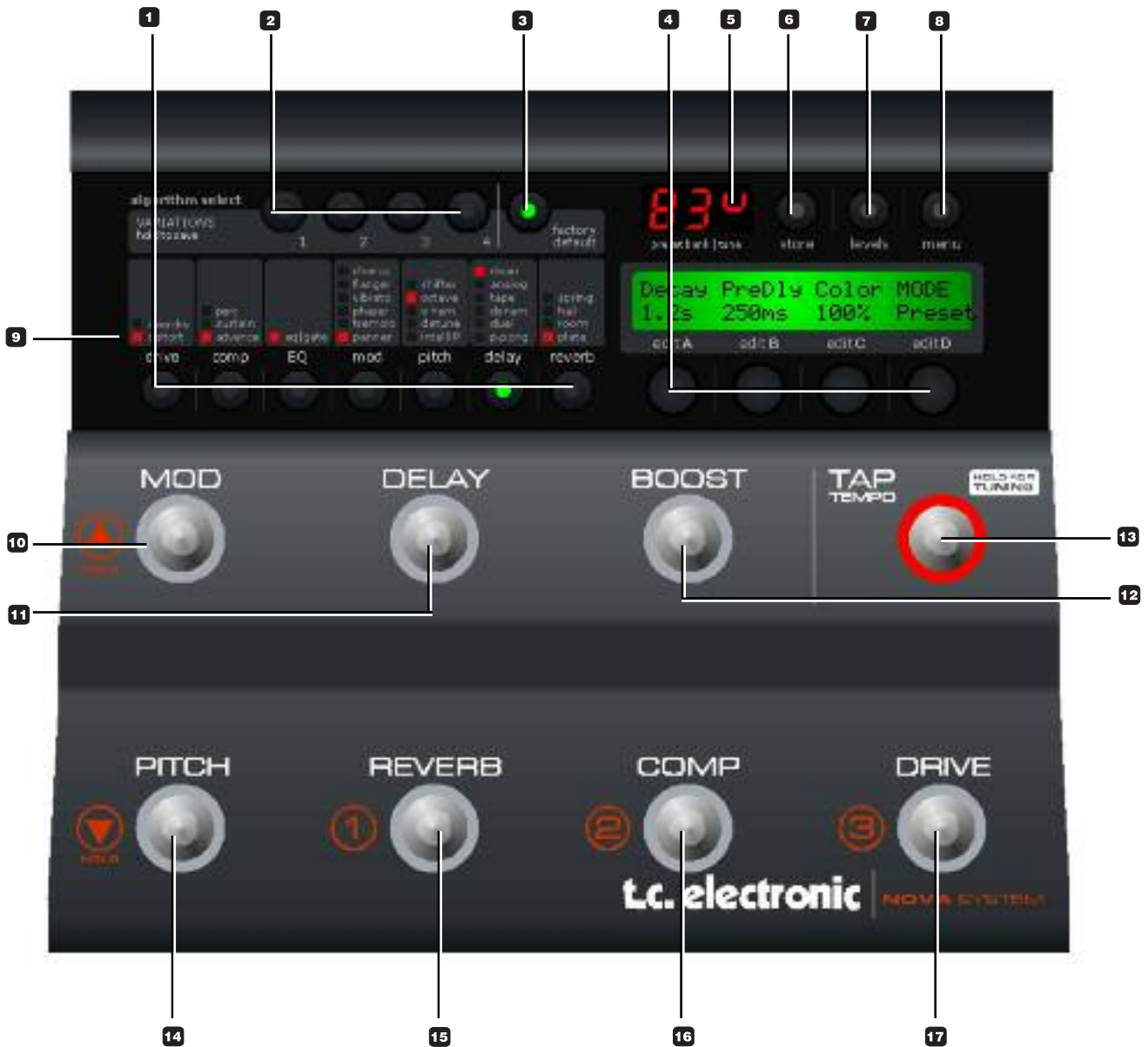

1 - Effects edit / Select buttons

Press once to enter edit mode for the current effect.
Press again to toggle between the different effect types.
Press and hold to exit the effects edit mode without saving.

2 - Variations

For each selected effect type, 4 instant variations can be stored. When creating new presets this function makes it very easy to combine your favorite reverbs with your favorite compression settings etc.

Example:

- Press COMP edit to enter the compression block.
- Edit the compression settings using encoders A-D.
- Now press and hold VARIATION key #1 to save this compression setting as one of your favorites. Note that the preset is not stored at this point, you have simply set up a favorite compression setting.
- Recall a different preset using the preset keys where you would like to apply this compression.
- Press COMP followed by VARIATION key #1.
- Your favorite compression setting #1 is now recalled into the current preset.

The VARIATION key LEDs:

When a VARIATION key LED is lit you have previously stored a variation with that key.

To delete a variation:

Press and hold "FACTORY DEFAULT" while pressing one of the VARIATION keys 1-4. This will delete the variation stored with that key.

3 - Factory Default

TC Electronic has predefined factory default settings for each algorithm. Press FACTORY DEFAULT to recall the default settings for the currently selected algorithm.

Example:

Assume that you have a very nice preset with a nice

combination of compression, EQ, mod and maybe delay settings. However, you feel that you have edited the reverb parameters to a point where you find yourself a bit lost. - What would TC Electronic suggest?

- We assume that you are in reverb edit, thus the REVERB EDIT LED is lit.
- Press FACTORY DEFAULT.



Note that there is a factory default setting for each effect sub-type.

4 - Edit A to D

EDIT encoders A to D is used to adjust parameters.

5 - Tuner Indications

In Tuner mode this section of the display indicates whether the input note is above or below correct pitch.

6 - Store

Storing a preset can be done in two ways. We call them "Quick store" and "Normal store". "Quick store" is typically used when you have made changes to a preset and want to store the preset with the same name at the same location. "Normal store" is used if you want to change preset location and maybe the name as well.

Quick store - press and hold STORE for 2 seconds. The preset is now stored at the current location.



If you are trying to store a factory preset using "Quick store", you will automatically be directed to "Normal store" mode.

Normal Store - press STORE once:

Now the following controls are available:

- Encoder A selects preset location
- Encoder B selects preset name characters

OPERATION

- Encoder C changes characters
 - Encoder D selects recall, delete or store mode
- When selections are made press STORE to confirm.

7 - Levels

Output levels can be set for each preset. All other parameters in the levels menu are “global” parameters and do not change with presets.



All preset parameters are marked with a “P” in the right side of the display.

8 - MENU button

Press to enter the following menus:

- Routing
- Pedal
- Modifiers
- MIDI
- Utility

The menus are described in later chapters of this manual.

9 - Effect status LEDs

The LEDs indicate which effect is selected in each block.

10 - MOD

On/off switch for the modulation block.

Secondary function:

Press and hold to increase preset bank.

11 - DELAY

On/off switch for the Delay block.

12 - BOOST

On/off switch for the Boost function. different boost levels can be set for individual presets from 0 to 10 dB.

13 - TAP (Tempo) & Hold for TUNING

This switch has two functions.

Tap Tempo:

By tapping the switch you enter the global tempo for NOVA System. This tempo can be used for delay and modulation effects.

Tuning:

Press and hold to enter Tuner mode. Per default the outputs are muted when in Tuner mode, but via the Tuner menu chose between setting the “Tuner Out” to mute or on. The Tuner parameters are automatically accessible when Tuner mode is accessed.

14 - PITCH

On/off switch for the Pitch block.

Secondary function:

Press and hold to decrease preset.

15 - REVERB or PRESET 1

In Pedal mode this switch acts as an on/off switch for the Reverb.

In Preset mode you may press this switch to recall preset #1 in the current bank.

16 - COMP or PRESET 2

In Pedal mode this switch acts as an on/off switch for the Compressor.

In Preset mode you may press this switch to recall preset #2 in the current bank.

17 - DRIVE or PRESET 3

In Pedal mode this switch act as an on/off switch for the Drive section. In Preset mode you may press this switch to recall preset #3 in the current bank.

REAR PANEL VIEW

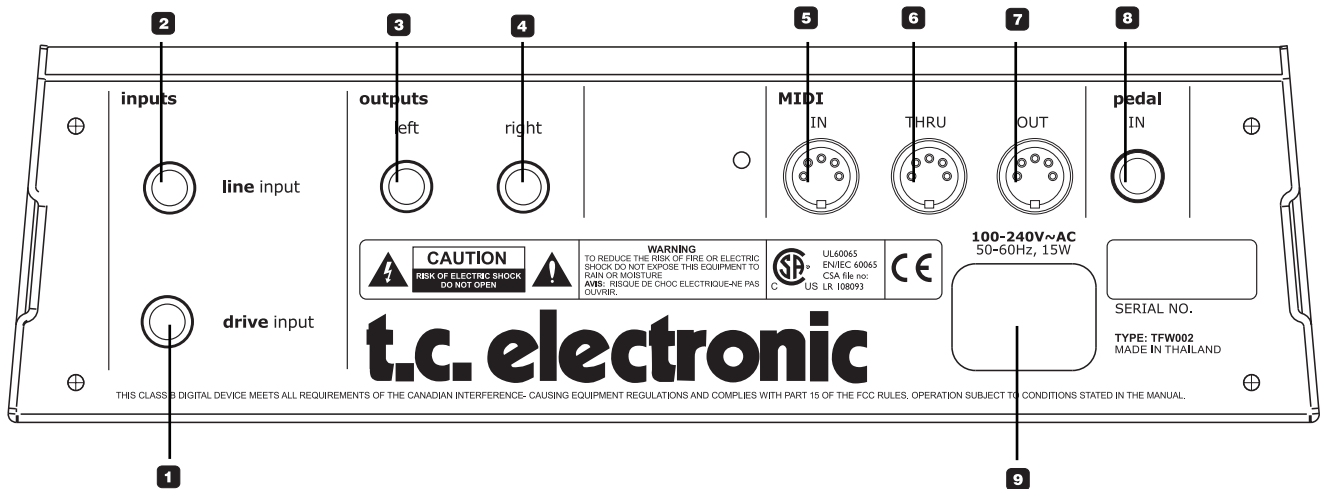

1 - Drive Input

Input for guitar. Use this input to utilize the programmable analog drive section of NOVA System.
Connection type: 1/4" jack.

2 - Line Input

In case you want to use the NOVA System in an effects loop of an amp, the "Effects Loop Send" should be connected to the NOVA System Line In. Then the NOVA System pre-amp section is bypassed and you use the preamp section of your amp for drive.

3/4 - Balanced Outputs

Balanced outputs on 1/4" TRS jack. Use the left output if you do not play in stereo and connect to a single amp.

5 / 6 / 7 - MIDI In / Thru / Out

Standard MIDI interface.

8 - Pedal In

Several types of external pedals can be connected and used to control parameters.

- Connect a G-Switch for preset change and thereby utilize all 8 switches on NOVA System as effects bypass switches.
- Connect an expression control e.g. volume. For perfect response when using an expression pedal, the pedal must be calibrated. This is done via the pedal menu.
- Via the pedal menu you can set up which parameter the expression pedal should control.

9 - Power In

The switchmode power-supply accepts from 100 to 240 VAC.

TYPICAL SETUPS

Basic setup

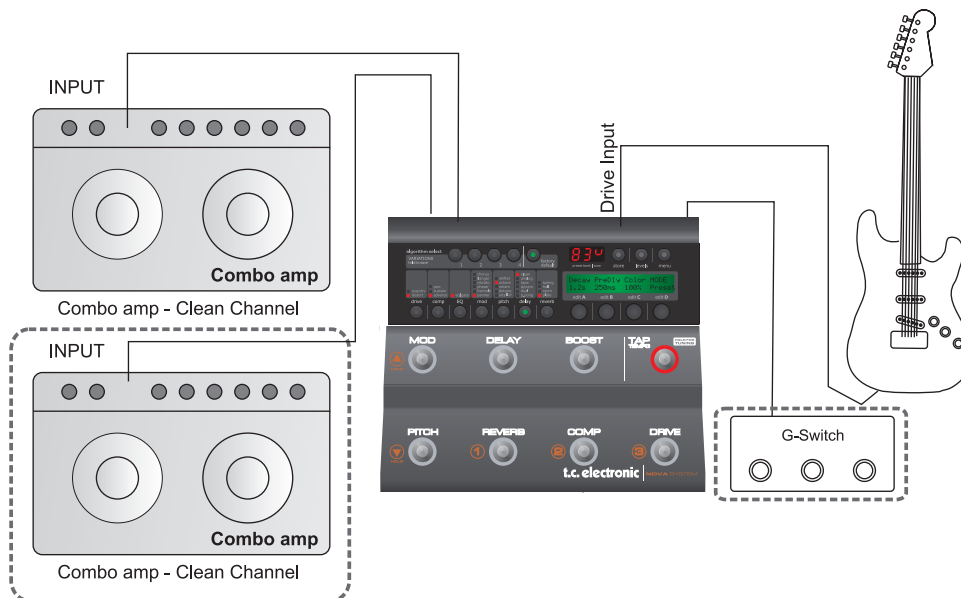

This is a typical basic setup combining NOVA System with one combo amp (or two for stereo) running a clean channel. All effects and overdrive/distortion are generated by NOVA System. A G-Switch (optional) is connected and the NOVA System is then automatically in stomp mode. Presets are then recalled using the G-Switch.

Connections

- Connect your guitar to the NOVA System's Drive input
- Connect Left output to a guitar amp running a clean channel
- Connect the right output to a second guitar amp for stereo (optional)
- Connect G-Switch (optional) to the pedal input

Basic settings

- Set input sensitivity via the Levels menu

With a G-Switch connected:

- Activate/deactivate effect blocks pressing the effects switches
- Change presets using G-Switch

With no G-Switch connected:

- Select the Footswitch parameter in the Utility menu and select Pedal (stomp) or Preset mode
- Select preset - if in preset mode
- Activate/deactivate effect blocks pressing the effects switches

NOVA System in an effects loop

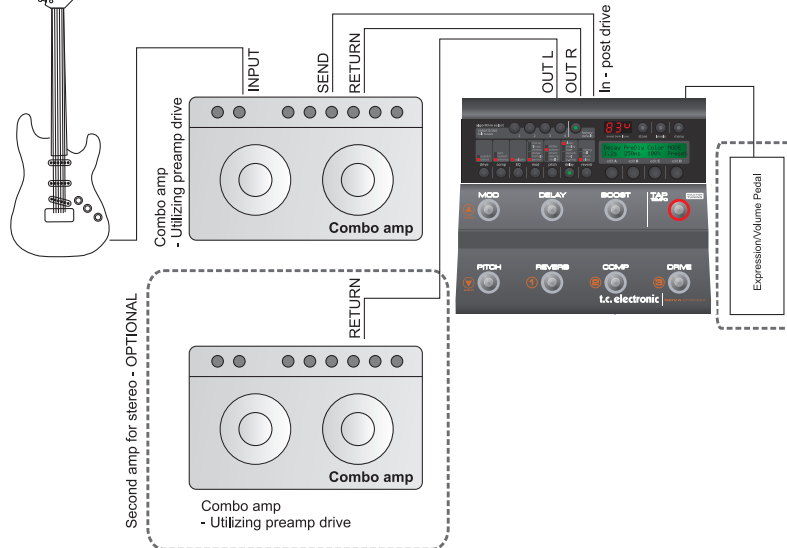

In this setup we use the preamp section of your combo amp to generate the drive. We use the Line input on the NOVA System and thereby bypass the NOVA Systems drive section. An expression pedal is connected to pedal in for real-time control of e.g. volume.

Connections

- Connect guitar to the input of the combo amp.
- Connect the effects loop “send” of the amp to NOVA Systems Line input.
- Connect left output to the effects loop return (=power amp in) of your amp. For a stereo setup connect the NOVA System right output to the effects loop return (power amp in) of the other amp.
- Connect an expression pedal to the NOVA System Pedal in.

Basic settings

- Set input sensitivity via the Levels menu according to the highest pedal level
- Select the Footswitch parameter in the Utility menu and select Pedal (stomp) or Preset mode
- Select preset (if in preset mode)
- Activate/deactivate effect blocks pressing the effects switches.
- Calibrate the expression pedal via the pedals menu
- Assign parameters to the expression pedal via the Pedal menu

MENU - ROUTING

Routing

NOVA System has three ways of routing the chain of effects: Serial, Semi Parallel and Parallel.

Basics

- Press MENU
- Select Routing using encoder D
- Press MENU to confirm
- Set values using encoders A, B and C
- Change pages using encoder D
- Confirm by pressing MENU
- Exit by pressing MENU again

Serial

The Serial routing connects all effect blocks “in a straight line”. This means that each effect block affects the following effect(s).

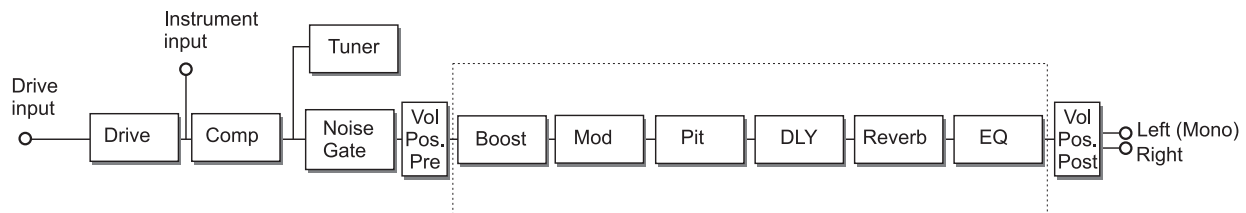

If a delay with a long delay time is used in combination with a reverb, you may find the added reverb on the delay repeats disturbing. In that case, use either the Semi Parallel or Parallel routing.

MENU - ROUTING

Semi Parallel

The Semi Parallel routing connects most effect blocks serially, but the reverb and delay blocks are now connected in parallel. Consequently, the delay and reverb effects do not affect each other. This means that no reverb is added to the delay repeats.

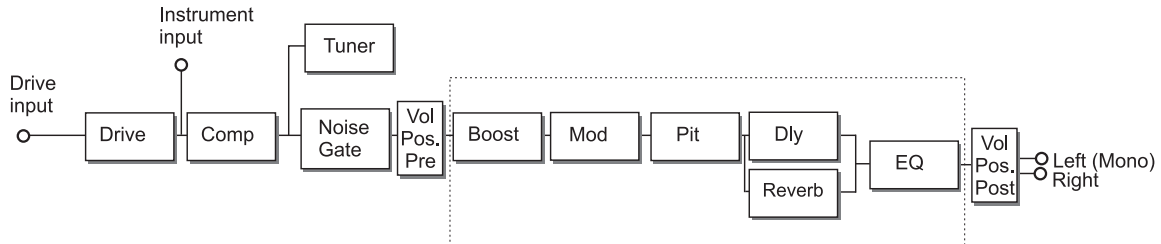

Parallel

In the Parallel routing, the same signal is fed to the input of the modulation, delay and reverb sections, and therefore these effects will not affect each other.

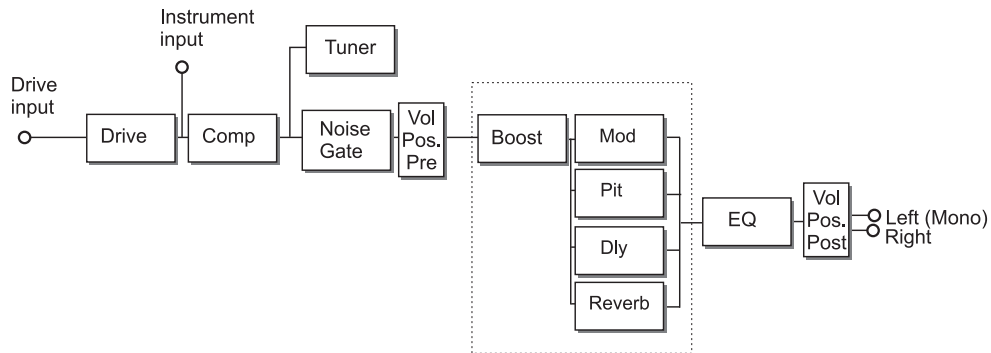

MENU - LEVELS

Levels menu

Basics

- Press LEVELS to access
- Set values using encoders A, B and C
- Change pages using encoder D

Where nothing else is stated the range of the level parameters is -100 dB to 0 dB.

Volume

Range: -100 dB to 0 dB

Level control that can be positioned either pre or post effects processing. The position of the volume control is set by the Position parameter (see also routing schematic).

Input Gain

Range: 0 dB to 24 dB

Guitars have different output levels. So has pedals you may have placed before the NOVA System. This is how you set the correct gain.

- Switch on any pedal in your signal chain that is placed prior to NOVA System and may boost the signal
- Strum your guitar as hard as you do when you play
- Adjust the line gain until the “0” appears:

```
LEVELS MENU >>>>>>>>>0
InputGain : 16 (unity)
```

- Then back off a few dB:

```
LEVELS MENU >>>>>>
InputGain : 14
```

- The correct gain is now set and you have unity gain through NOVA System.

Clipping indication

If you change the input gain considerably, e.g. by switching to a different guitar or changing levels on a pedal placed before the NOVA System, the input of the NOVA System may be clipping. This is indicated by the small dot in the far rightmost side of the numeric display:

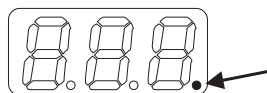

Left Output & Right Output

Range: -100 dB to 0 dB

Individual level control for left and right outputs. These levels can be set per preset.

Input

Range: Drive or Line

Selects the input. Select “Drive” if you have connected your guitar to the Drive input and want to utilize the NOVA Systems Drive effect block.

Select “Line” if you have connected your guitar to the Line input. (see also routing schematic).

Volume Position

The Volume parameter is typically controlled by an expression pedal. If you connect an expression pedal to the pedal input the pedal will control this parameter per default.

The Volume Position parameter defines where the volume is controlled. The options are:

Pre: The volume is controlled right *after* the Drive section and *before* the effects. This allows for effects such as Delay and Reverb to “hang”, even if you lower the level using an expression pedal.

Post: The volume is controlled *after* the effects. This means that the volume of the entire signal, including effects, is controlled.

Advanced

Range: On or Off

Select “on” to gain access to the following “advanced” level parameters. Once you are in advanced mode you no longer benefit from automatic “unity gain” calculations described on the previous page under the Input Gain section. On the other hand you will have full control of the level parameters.

Boost Max

Range: 0 to 10 dB

This setting determines the max range of the boost function. As 0 dBFS is the max level in the digital domain digital “boost” is done by attenuating the general level and releasing this attenuation when boost is required. If you use the Advanced mode and the boost function, the Output Range parameter can be adjusted to ensure unity gain through the unit.

If you select advanced mode but never use the Boost function at all, set the Boost Max parameter to 0 dB.

Output Range

Options: 2 dBu, 8 dBu, 14 dBu or 20 dBu

Which output setting to select depends on the set InGain. The higher the InGain is set, the lower the Output Range parameter should be set.

Boost

Wouldn't it be nice if you could just hit a single switch and boost the entire signal for a few important phrases? With the NOVA System boost function it is easy. Via the Levels Advanced menu a max boost level between 0 and 10 dB is set. Within the Boost max level you can set up a boost level for individual presets.

- press LEVELS to access the levels menu
- select “Advanced” and set this parameter to “on”
- scroll to BoostMax and set your boost max level

```
LEVELS MENU
BoostMax : 6dB
```

- then exit the menu and select the preset you want to set up a boost level on.
- press DRIVE and set the boost level within the Boost Max range.

Additional parameters for the Boost function:

Boost Lock:

Range: On or Off

When Boost Lock is set to “on”, you are able to boost the amount of dB specified by the Boost Max. parameter on ALL presets. The Boost Lock parameter is found in the Utility menu.

Boost Level:

The boost level can be set for each preset within the range of the Max Boost parameter. This range is set in the Levels menu.

MENU - PEDAL

Pedals menu

Basics

- Press MENU to access
- Select Pedal using encoder D
- Press MENU to confirm
- Set values using encoders A, B and C
- Change pages using encoder D
- Confirm selection by pressing MENU if <menu> flashes in the right side of the display
- Exit by pressing MENU again

For external control of certain parameters you can connect an expression pedal.

In this menu you assign which parameters to assign, calibrate NOVA System to the connected expression pedal and also dial in a response curve using the min, mid and max parameters.

Parameters marked with “P”

Some of the parameters in this menu are global parameters and some are saved at preset level. Parameters saved with each preset are marked with “p” in the right side of the display.

Example:

```
PEDAL MENU      <menu>
Map Param.: DLY DELAY P
```

Connecting Expression pedals

Depending on the type of expression pedal used, the pedal should be connected using either a regular mono 1/4" TS-TS cable or a stereo 1/4" TRS to TRS cable.

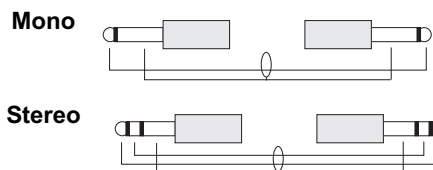

If you are not sure which type to use, you may have to try both types. NOVA System measures the signal on your expression pedals output connector. Therefore only one cable should be used per expression pedal.

Map Parameter

Assigning parameters to the pedal connected to the “Pedal Input”

- Go to Pedal menu pressing MENU several times

```
PEDAL MENU      <menu>
Map Param.: DLY DELAY P
```

- Select a parameter to control from the list
- Press MENU to confirm
- Set Min Mid Max

Min - Mid - Max

Range: 0-100%

These settings determine the parameter response according to an expression pedal connected to the Pedal input. Values can be set for both the minimum, mid and maximum position of the pedal.

Master

If an expression pedal is connected to the pedal input and a preset is recalled, NOVA System can be set up to respond to either the current position of an expression pedal or to the value stored with the preset.

Preset: The parameter value stored as part of the preset applies – regardless of the current position of the expression pedal.

Pedal: The position of the expression pedal is identified at the moment of preset change, and the value stored as part of the preset is discarded.

Type

Select between either Expression or G-Switch depending in the type of switch you have connected to the Pedal input. Expression pedals must be calibrated (see below). When a G-Switch is connected and selected as pedal type the G-Switch is used to change presets and all 8 switches on the NOVA System are used as “stomp on/off” switches.

Calibrating to an expression pedal

In order to secure the best performance of your expression pedal, NOVA System must be calibrated to this pedal. Follow this step by step guide.

- Make sure that you have connected your pedal to the pedal connector on the rear panel
- Select “Calibrate from the Pedal Menu

```
PEDAL MENU  
CALIBRATE <menu>
```

- Press MENU
- The LCD now reads

```
PEDAL CALIBRATE  
Set Min: 0 <menu>
```

- Place your pedal in minimum position (“Heel down”) and press MENU



- The LCD now reads

```
PEDAL CALIBRATE  
Set Max: 0 <menu>
```

- Place your pedal in maximum position (Toe down) and press MENU



- The LCD reads: “CALIBRATION DONE”

```
PEDAL CALIBRATE  
> CALIBRATION DONE <
```

MENU - UTILITY

Utility

Basics

- Press MENU to access
- Select Utility using encoder D
- Press MENU to confirm
- Set values using encoders A, B and C
- Change pages using encoder D

FX Mute

The FX Mute parameter determines how the Reverb and Delay effects should behave when changing between presets and when bypassing one of these effects.

Soft:

Delay and Reverbs will “ring out”

Delays have true spillover, meaning that if you e.g. have a long delay time and the FX Mute parameter is set to “Soft” the delays will continue even if you change to a preset that holds completely different delay settings.

Reverbs can also spill over at preset change but will use the settings in the new preset.

Hard:

Delay and Reverbs will mute.

Tap Master

A preset holds both a subdivision parameter that relates to the global tapped tempo and also a fixed delay time. The tap tempo master parameter defines how NOVA System responds to the global tapped tempo at preset change.

Preset:

With Tap Master in Preset mode the delay repeats will play according to the delay time stored with the preset. As soon as you tap, maybe to make a slight correction, the tapped tempo plays according to the set subdivision.

Global:

With Tap Master in Global mode the current tapped global tempo and the set sub-division applies instantly at preset change.

Boost Lock

Range: On or Off

When Boost Lock is set to “on” you will be able to boost the amount of dB specified by the Boost Max. parameter on ALL presets.

EQ Lock

Range: On/off

When EQ is locked the current EQ will be used on ALL presets.

Routing Lock

Range: On/off

If you always use the same routing you may prefer to lock the current routing.

FactoryLck (Factory Bank Lock)

Range: On/off

NOVA System comes with a selection of factory presets to show the many different sounds and effects you can create with NOVA System. However, as you begin you create you own bank of presets you may prefer not to be able to select factory sounds in a live situation. In that case set Factory Bank Lock to “on”. You will then NOT scroll through factory banks when you use the bank up/bank down functions.

SpeakerSim (Speaker Simulator Filter)

Range: On/Off

With the NOVA System speaker simulator you are able to emulate the attenuation of high-end frequencies that naturally occurs when playing through guitar-speaker cabinets.

Use the speaker simulators “on” option when you connect the NOVA System outputs directly to recording inputs of an audio interface (e.g. TC Konnekt), or when plugging directly into a mixer.

MENU - UTILITY



The NOVA System EQ section is not available when SpeakerSim is invoked.



Always set the SpeakerSim parameter to “off” when plugging the NOVA System outputs into a regular guitar amplifier. Otherwise you will have both a speaker and a filter emulating a speaker at the same time. With this combination you will most likely find your gear sounding dull.

Footswitch

Range: Pedal or Preset

Pedal mode:

In pedal mode all footswitches act as effects on/off switches (+Tap tempo). Pretty much as a you would use eight regular stomp box pedals. However, it is still possible to change both preset banks and presets when in this mode.

Changing presets:

- press and hold one of the three preset switches.

Changing banks:

- press and hold one of the two left-most buttons (MOD or PITCH). The three preset buttons and the MOD and PITCH switches will blink indicating that you are in bank select mode.
- Now either tap MOD or PITCH to step through preset banks one at a time or hold on of the switched to scroll up/down.

Preset mode (default setting):

In preset mode you recall presets by pressing one of the three preset switches. Preset banks are selected as described in the paragraph “changing banks”.

Pedal mode - with G-Switch connected:

With a G-Switch connected to Pedal In on the rear panel, this switch can be used to recall presets. This way you can use all seven effects on/off switches for effects bypass and use the G-Switch for instant preset recall.

We think this is the “best of both worlds”.

The G-Switch must be selected as pedal type in the pedals menu.

```
PEDAL MENU
Type       : G-Switch
```

View Angle

Adjust to get the best display viewing angle.

Clear System

Clear system will set NOVA System back to factory default settings. - Press MENU to execute and confirm.

THE TUNER

Basics

- To activate the Tuner, press and hold the TAP TEMPO switch
- Set values using encoders A, B and C
- Change pages using encoder D
- Press any footswitch to exit.

In Tuner mode the following parameters can be set.

Tuner Out

Mute:

Output is muted when in tuner mode.

On:

Output is not muted when in tuner mode.

Tuner Ref

Range: 420 to 460 Hz

This parameter sets the general tuner reference. Default setting is 440 Hz.

Example - tuning a guitar:

- Press and hold the footswitch in the lower right corner until Tuner mode is accessed.



- Play e.g. the A string. Let ring.

If the note is within +/- 100 cent around "A" the tuner will recognize the note A and indicate whether the pitch of the note is too low, too high or in tune.

Too high

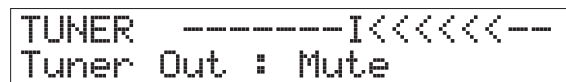

Too low



In tune



MIDI Setup menu

Navigation

- Press MENU to enter menu
- Select MIDI Setup menu using Encoder D
- Press MENU to enter
- Change page using encoder D
- Change parameters using encoder C

```
MIDI SETUP MENU
MIDI Chan : 1
```

MIDI Channel

Range: Off, 1 to 16 or Omni

When Omni is selected, the NOVA System receives MIDI information on all channels. When set to “Off”, the NOVA System does not respond to any incoming MIDI data.

Program Change In

Range: On/Off

Determines whether the NOVA System should respond to incoming MIDI program changes or not.

Program Change Out

Range: Off/On

This parameter and the Prg. Map parameter concern the MIDI program change information sent on MIDI out when a preset is recalled on NOVA System.

Off: No program changes are sent on MIDI out.

On: Program changes are sent on MIDI out when presets are recalled.

PrgMap - Program Map

The Program Map function allows you to map an incoming MIDI program change from an external MIDI device to recall any preset. In the following example incoming MIDI program change #1 will recall preset #2 in Factory bank #0.

```
MIDI MENU
PrgMap 1 -> F0-2
```

Factory presets are labeled “F” and User presets are labeled 00-1 to 20-3.

The PrgMap settings also apply on MIDI out. So if we look at the example above. Recalling preset number #2 in factory bank #0 will send program change #1 on MIDI out.

Prg. Map Reset

Press MENU to reset the Program Map.

SysEx ID

Range: 0 to 126 - ALL

Sets the NOVA System’s SysEx ID for identification in larger MIDI setups.

Dump System*

For a complete system backup, press MENU. All the NOVA System’s global settings sent via MIDI as a MIDI Data Dump. Presets are NOT included - see below.

Dump Bank*

The entire User bank is sent via MIDI as a MIDI Data Dump when “Execute Dump” is performed.

How to Dump via MIDI – Step by Step:

- Connect the NOVA System’s MIDI Out to the MIDI In of a MIDI sequencing device.

MIDI

- Set your sequencer to record on all MIDI channels (“Omni”) and start recording.
- Set the NOVA System to dump either all data (System) or User Bank (see above) and press ENTER.

*A computer with a standard MPU 401 MIDI interface is recommended and tested for best results.

MIDI Clock

With this function enabled you can receive a MIDI clock from an external MIDI unit and thereby enter the global tempo this way instead of tapping the tempo.

MIDI CC menu

This menu allows for external MIDI control of effects on/off, tap tempo function and real-time control of the parameter assigned to the expression pedal.

Basics

- Press MENU
- Select MIDI CC and press MENU
- Select parameters using encoder D
- Set MIDI CC values using encoder A, B or C

MIDI CCs

For each function you can set a MIDI Cc (control change) number. This is the number the external device must address followed by a value to control the parameter.

Controllable parameters:

<u>Parameter</u>	<u>Menu Name</u>	<u>Values</u>
Tap Tempo	Tap Tempo	: Off, MIDI CC 0 to 127
Drive	DRV Off/On	: Off, MIDI CC 0 to 127
Compressor	CMP Off/On	: Off, MIDI CC 0 to 127
Noise Gate	NG Off/On	: Off, MIDI CC 0 to 127
EQ	EQ Off/On	: Off, MIDI CC 0 to 127
Boost	BST Off/On	: Off, MIDI CC 0 to 127
Modulation	MOD Off/On	: Off, MIDI CC 0 to 127
Pitch	PIT Off/On	: Off, MIDI CC 0 to 127
Delay	DLY Off/On	: Off, MIDI CC 0 to 127
Reverb	REV Off/On	: Off, MIDI CC 0 to 127
Expr. pedal	Exp Pedal	: Off, MIDI CC 0 to 127

RECALL - EDIT

Recall

Recalling presets are done in slightly different ways depending on whether you are in Preset or Pedal mode.

In Preset mode

Presets are recalled pressing the switches marked 1, 2, or 3.



To increase the preset bank number, press and hold the switch in the upper left corner:



To decrease the preset bank number; press and hold the switch in the lower left corner:



In Pedal mode

Presets are still recalled using switches marked 1, 2 or 3. However in this mode you must press and hold the switches for about 0.5 second. Preset banks are still selected as described above.

Edit

As soon as one of the seven EFFECTS EDIT switches are pressed NOVA System is in edit mode.

In Edit mode you have several options:

Selecting effects: Press one of the EFFECTS EDIT buttons to enter edit mode.

Example: Drive selected

Gain	Tone	Level	Boost
15	50%	0dB	6dB

Press several times to select the desired effects algorithm.

Enable/Disable effect: Though you may be editing an effect, the effect block may not be active. Effects are enabled/disabled by pressing the corresponding EFFECT switch.



Exit edit mode without storing changes: If you want exit edit mode without storing your changes this can be done in two ways. Either press MENU, or press and hold the EFFECTS EDIT button of the effect you are currently editing.

A dot in the numeric display (see illustration below), indicates that the current preset has been edited.

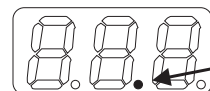

Store

A preset can be stored in two ways. We call them “Quick store” and “Normal store”. “Quick store” is typically used when you have made changes to a preset and want to store the preset with the same name at the same location. “Normal store” is used if you want to change preset location and maybe the name as well.

Quick store - press and hold STORE for 2 seconds. The preset is now stored at the current location with the same name.



If you are trying to store a factory preset using “Quick store”, you will automatically be directed to “Normal store” mode.

Normal Store - press STORE once:

Now the following controls are available:

- Encoder A selects preset location
- Encoder B selects preset name characters
- Encoder C changes characters
- Encoder D selects recall, delete or store mode

When selections are made press STORE to confirm.

Delete

Presets in the User bank can also be deleted for “cleaning up”.

- Press STORE once
- Select DELETE using Encoder D
- Press STORE to confirm

That’s it!

EFFECTS - DRIVE

NOVA Drive Technology - a unique, new drive and distortion circuit that gets you the best of both worlds: World-class analog distortion and overdrive with digital control. This is the real deal – no modeling. While the NDT™ is 100% analog and physically separated from the digital effects, its control potmeters are digital. This way you can tweak, store and recall as many drive settings as you want - you can even hook up an expression pedal and control the amount of distortion in real-time. Its wide gain range covers your every need from light breakup to heavy distortion.

Overdrive

The NOVA System overdrive emulates the classic overdrive originally only in found tube amps. The range goes from slightly warm and subtle overdrive to high gain for screaming leads.

Gain

Gain sets the amount of overdrive. Lower settings give a slightly fatter yet still “clean” sound. Medium settings provides nice crunch and higher gain settings provides singing overdrive as known from cranked up tube amps.

Tone

Sets the amount of high-end frequencies.

Level

General level for the drive effect.

Boost Level

Range: 0 to 10 dB

Sets the amount of boost for the effect. This level is limited by level set by the Boost Max parameter found in the levels menu.

Distortion

The nature of distortion compared to overdrive is more fat and aggressive with slightly less tone definition and dynamics. It allows for full and massive chords and fluent compressed leads.

Gain

Gain sets the amount of distortion. From the fat and beefy to the screaming more compressed.

Tone

Sets the amount of high-end frequencies.

Level

General level for the distortion effect.

Boost Level

Range: 0 to 10 dB

Sets the amount of boost for the effect. This level is limited by level set by the Boost Max parameter found in the levels menu.

Compressor

Introduction

A compressor is used to control the dynamic content of a signal. It can be used both for leveling out the signal's dynamics (thereby letting your guitar sound stand out clearer) and also for more radical, very recognizable effects.

NOVA System offers three types of compression. Advanced for full access to all compression parameters and sustaining

Illustration – Basic Compression

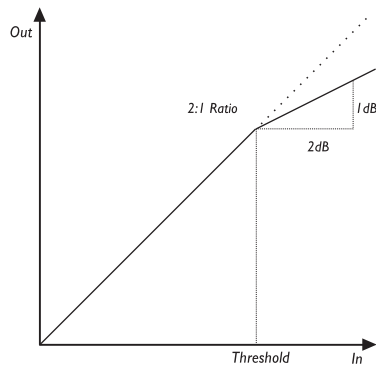

As this illustration shows, the output signal is attenuated relative to the set ratio when the input signal exceeds the threshold point. The attack parameter specifies how fast the attenuation is achieved. The Level parameter allows you to manually compensate for the perceived level difference resulting from compression.

NOVA System compressors

Editing compressor parameters:

- Press COMP
- Change pages using encoder D
- Adjust parameters using encoders A-C

Advanced Type

This type offers full control over all compression parameters.

Threshold

Range: -30 dB to 0 dB

When the signal exceeds the set threshold point, the compressor is activated. The signal's level above this threshold point is processed according to the settings of the Ratio, Attack and Release parameters (see below).

Ratio

Range: Off, 1.12:1 to Infinite:1

This parameter determines how hard the signal is compressed.

Example: With a Ratio setting of 2:1, an input signal with 4 dB above threshold is reduced to only 2 dB on the output. The “infinite” setting gives you a limiter function.

Attack

Range: 0.3 ms to 140 ms

The attack time is the response time of the compressor. The shorter the Attack time, the sooner the compressor will reach the specified ratio after the signal rises above the threshold point.

Release

Range: 50 to 2000 ms

The release time is the time it takes for the compressor to release the gain reduction of the signal after the Input signal drops below the threshold point again.

EFFECTS - COMPRESSOR

Level

Range: - dB to +12 dB

Depending on your compression settings you may prefer to lower the output level of the compression block by a few dB. Use the compressor Level parameter to do so.

Sustaining and Percussive Types

The Sustaining and Percussive Types hold fewer handles than the Advanced mode. Individually tuned these types allow you to easily setup commonly used compression styles.

Use the Sustaining type to achieve the subtle compression settings that will give you plenty of sustain without “smashing” the sound too hard.

Use the Percussive type to obtain the hard, obvious and easy recognizable compression often achieved with classic stomp box compressors

Though tuned differently the two types hold common parameters.

Drive

Range: 1 to 20

A combination of Threshold and Ratio parameters that sets the compression amount. Though auto make-up gain is applied you may need to adjust the level slightly using the Gain parameter when extreme settings are used.

Response

Range: 1 to 10

Sets the time it takes for the Compressor to release the compression. The lower setting the more you will hear the compression.

Level

Range: -12 to +12 dB

Depending on the settings of Drive and Response parameters you may need to adjust the Level.

EFFECTS - EQ & NOISE GATE

EQ

NOVA System features a 3 band EQ that can be set either for individual presets or as an overall EQ for the entire unit.

Editing EQ and Noise Gate parameters:

- Press EQ to enter EQ/Gate edit mode
- Change pages using encoder D
- Adjust parameters using encoders A-C
- Noise Gate parameters are located after EQ parameters

For each of the three bands, the following parameters are available:

Freq

Range: 41 Hz to 20 kHz

This parameter sets the center frequency of the frequency range that you want to attenuate or boost.

Gain

Range: -12 dB to +12 dB

Use this parameter to attenuate or boost the frequency range selected with the Freq(uecy) parameter.

Width

Range: 0.3 to 1.6 octaves

This parameter sets the width of the frequency range around the frequency specified by the freq(uecy) parameter.

Noise Gate

A Noise Gate is generally used to attenuate the signal when no signal is present and thus attenuate the hiss, hum and other noise you might have on your system. Of course a Noise Gate is not the solution to any noise problem. You should try to avoid the noise in the first place. Problems with noise can be introduced by a number of different things. In a guitar signal chain the typical problems are; poor cables, poorly shielded pickups, power supplies placed close to signal cables and other pedals.

There will, however, always be a certain amount of noise in any setup. The Noise Gate can help you attenuate the noise when you are not playing. Be careful when setting Threshold and Release parameters. A too high Threshold setting will result in e.g. not “opening” the Gate. A too slow Release time will result in cutting your attack.

The Noise Gate parameters are placed in the EQ block after the EQ parameters.

- Press and hold the EQ button to select between Line and Drive inputs.
- Be sure that “Gate” is set to “on”

EQ	On			Gate	On
----	----	--	--	------	----

- Scroll past the EQ pages until the following two screens with Noise Gate parameters appear.

Gate			
Soft			

Thres	Damp	Releas
-31dB	50dB	100dBs

EFFECTS - EQ & NOISE GATE

Mode

Range: Hard or Soft

General overall mode that determines how fast the Noise Gate should attenuate/dampen the signal when below Threshold.

Threshold

Range: -60 dB to 0 dB

The threshold point determines at what point the Noise Gate should start attenuating the signal.

To set this parameter; set the Damp parameter to e.g. 50 dB. Then start turning up the Threshold value from -60 dB to the point where desired dampening is actually achieved. This little experiment will of course require that the Damp parameter is set different from 0 dB - as 0 dB means: no damping.

Damp

Range: 0 dB to 90 dB

This parameter determines how hard the signal should be attenuated when below the set Threshold. You could argue that a max dampening would be appropriate always, but you would also like to have a smooth transition between the "gated/attenuated" stage and the "open" stage. The more dB that must be released the more obvious the Noise Gate might seem.

Release

Range: 0 dB/sec to 200 dB/sec

The Release parameter determines how fast the signal is released when the Input signal rises above the Threshold point. As a rule of thumb this setting should be set fairly high.

Phaser

The electronic phasing effect is created by splitting an audio signal into two paths. One path treats the signal with an all-pass filter, which preserves the amplitude of the original signal and alters the phase. The amount of change in phase depends on the frequency. When signals from the two paths are mixed, the frequencies that are out of phase will cancel each other out, creating the phaser's characteristic notches.

Speed

Range: 0.050 Hz to 20 Hz
Sets the speed of the effect.

Tempo

Range: Disable, 1 to 1/32T (T=Triplet & D=Dotted)
When set to any value between 1 and 1/32T, the NOVA System's Global Tempo is subdivided according to this setting. When set to "Ignore", the speed set by the Speed parameter is used instead.



The Tap Master parameter – located in the Utility menu – specifies whether the *Global* tempo or the tempo set by the Speed parameter in each preset should be used at preset change.

Depth

Range: 0 to 100%
The Depth parameter specifies the intensity of the effect. The value represents the amplitude of the modulating waveform.

Range

Range: Low or High
The Range parameter determines whether the phasing is focused on the low- or the high-end frequencies.

Fb – FeedBack

Range: -100 to +100%
This parameter controls the amount of feed back in the Phaser. Negative values inverse the phase of the signal that is fed back to the algorithm's Input.

Mix

Range: 0 to 100%
This parameter sets the relationship between the dry signal and the level of the effect in this Effect Block.

EFFECTS - TREMOLO

Tremolo

A tremolo is basically a change of the signal level controlled by an LFO. The NOVA System offers variations of this effect; ranging from soft and smooth to hard and aggressive.

Speed

Range: 0.050 Hz to 20 Hz

This parameter sets the speed of the effect.

Tempo

Range: Disable, 1 to 1/32T (T=Triplet & D=Dotted). When set to any value between 1 and 1/32T, the NOVA System's Global Tempo is subdivided according to this setting. When set to "Ignore", the speed set by the Speed parameter is used instead.

Depth

Range: 0 to 100%

The Depth parameter specifies the intensity of the effect. The value represents the amplitude of the modulating waveform.

Type

Range: Soft or Hard (Sine or Square)

Two waveforms are available as modulation sources for the tremolo effect. Setting this parameter to hard results in a steeper effect. Listen and choose the appropriate option.

Soft



Hard



Width

Pulsewidth



Range: 0 to 100%

If you set this parameter e.g. to 20% with a Type setting of Hard, the waveform will be on for 80% of one period. With a Type setting of Soft, a 50% setting would yield a full sine wave, whilst 0% and 100% would yield a crest-to-peak and peak-to crest curve, respectively.

Hi-Cut

Range: 20 Hz to 20 kHz

This parameter attenuates the high frequencies of the Tremolo effect. Use the hi-cut filter to create a less dominant tremolo effect without changing the effect's depth.

Panner

Introduction

The Panner simply pans the signal between the left and the right channel. Use this for extreme stereo perspective effects.

Speed

Range: 0.050 Hz to 20 Hz
Sets the speed of the effect.

Tempo

Range: Ignore, 2 to 1/32T (T=Triplet & D=Dotted)
When set to any value between 2 and 1/32T, the NOVA System's Global Tempo is subdivided according to this setting. When set to "Ignore", the speed set by the Speed parameter is used instead.



The Tap Master parameter – located in the Utility menu – specifies whether the *Global* tempo or the tempo set by the Speed parameter in each preset should be used at preset change.

Depth

Range: 0 to 100%
When you set this parameter to 100%, the signal will sweep fully from the left to right. You will find, however, that for most applications, a more subtle setting is more appropriate, as it blends more elegantly with the overall sound.

EFFECTS - CHORUS

Chorus

The NOVA System Chorus offers a full range of parameters allowing you to create from simple classic chorus sounds to the more exotic types.

The basic idea of a chorus effect is to split the signal and pitch modulate one of the signals slightly, then mix the two signals again.

Speed

Range: 0.050 Hz to 20 Hz

This parameter sets the speed of the effect.

Tempo

Range: Disable, 1 to 1/32T (T=Triplet & D=Dotted)

When set to any value between 2 and 1/32T, the NOVA System's Global Tempo is subdivided according to this setting. When set to "Ignore", the speed set by the Speed parameter is used instead.



The Tap Master parameter – located in the Utility menu – specifies whether the *Global* tempo or the tempo set by the Speed parameter in each preset should be used at preset change.

Depth

Range: 0 to 100%

The Depth parameter specifies the intensity of the effect. The value represents the amplitude of the modulating waveform.

Hi-Cut

Range: 20 Hz to 20 kHz

This parameter reduces the high-end frequencies in the Chorus effect. Try using this parameter if you feel the Chorus effect is too dominant in your sound and turning down the Mix or Out level doesn't give you the dampening of the Chorus effect you are looking for.

Cho DI – Chorus Delay

Range: 0 to 50 ms

As described earlier, a Chorus/Flanger is basically a Delay being modulated by an LFO. This parameter allows you to change the length of that Delay. A typical Chorus uses Delays at approximately 10 ms, while a Flanger uses Delays at around 0.8 ms.

Mix

Range: 0 to 100%

This parameter sets the relationship between the dry signal and the level of the effect in this Effect Block.

Flanger – Introduction

The Flanger belongs to the same “family” of modulation effects as the Chorus effect. The signal is split, and one of the signals is pitch modulated.

The characteristic “flanging” sound occurs when part of the signal is slightly delayed and fed back to the input of the effect algorithm. Experiment with the Feedback parameter to get a feeling for the achievable effects.

Speed

Range: 0.050 Hz to 20 Hz

This parameter sets the speed of the effect.

Tempo

Range: Disable, 1 to 1/32T (T= Triplet & D= Dotted)

When set to any value between 2 and 1/32T, the NOVA System’s Global Tempo is subdivided according to this setting. When set to “Ignore”, the speed set by the Speed parameter is used instead.



The Tap Master parameter – located in the Utility menu – specifies whether the Global tempo or the tempo set by the Speed parameter in each preset should be used at preset change.

Depth

Range: 0 to 100%

The Depth parameter specifies the intensity of the effect. The value represents the amplitude of the modulating waveform.

Hi-Cut

Range: 20 Hz to 20 kHz

This parameter reduces the high-end frequencies in the Flanger effect. Try using this parameter if you feel the Flanger effect is too dominant in your sound and turning down the Mix or Out level doesn’t give you the dampening of the Flanger effect you are looking for.

FeedB – Feedback

Range: -100 to 100

This parameter controls the amount of Feedback (Resonance) of the short modulated delay that causes the Flanging effect. When the Feedback is set too high (above approximately 90% to 95%), this might introduce internal Feedback, resulting in a squealing noise that in most cases is unwanted in flanging effects. Be aware of this side-effect when experimenting at high volumes. Negative values inverse the phase of the signal that is fed back to the algorithm’s Input.

FB Cut – Feedback hi-cut

Range: 20Hz to 20kHz

A parameter that can attenuate the high-end frequencies of the resonance created with the Feedback parameter.

Fla DI – Flanger Delay

Range: 0 to 50 ms

Typically, Delay values around 0.8 ms are used for Flanging effects, whereas Chorus effects occur with Delay times around 10ms. You are free, however, to choose Delay times from 0 to 50ms.

Mix

Range: 0 to 100%

This parameter sets the relationship between the dry signal and the level of the effect in this Effect Block.

EFFECTS - VIBRATO

Vibrato

The vibrato effect modulates the pitch of the incoming signal. The result is similar to the vibrato technique used by vocalists. In contrast to a chorus or flanger effect, no direct signal is combined with the pitch-modulated signal.



Speed

Range: 0.050 Hz to 20 Hz
Sets the speed of the effect.

Tempo

Range: Disable, 1 to 1/32T (T= Triplet & D= Dotted).
When set to any value between 2 and 1/32T, the NOVA System's global tempo is subdivided according to this setting. When set to "Ignore", the speed set by the speed parameter is used instead.



The Tap Master parameter – located in the Utility menu – specifies whether the Global tempo or the tempo set by the speed parameter in each preset should be used at preset change.

Depth

Range: 0 to 100%
The Depth parameter specifies the intensity of the effect. The value represents the amplitude of the modulating waveform.

Hi-Cut

Range: 20 Hz to 17.8 kHz / off
This parameter reduces the high-end frequencies in the vibrato effect. Try using this parameter if you feel the effect is too dominant.

Detune

The detune effect is – to some extent – similar to a chorus: The source signal is split and a specified amount of the signal is detuned by an adjustable amount of cents (100 Cent = 1 semitone). The main difference between the detune effect and the chorus effect is that the detune amount does not change: the modulating pitch is specified as an offset to the original pitch.

The detune effect comprises two voices. If you think your sound is simply too direct and clean, try a setting with only a few cent off, on both voices – e.g. +2 cent on voice 1 and -3 cent on voice 2.

Voice 1

Range: -100 to 100

This parameter determines the pitch offset of the first voice in the Detune block.

Voice 2

Range: -100 to 100

This parameter determines the pitch offset of the second Voice in the Detune block.

Delay 1

Range: 0 to 50 ms

This parameter specifies the delay of Voice 1.

Delay 2

Range: 0 to 50 ms

This parameter specifies the delay of Voice 2.

Mix

Range: 0 to 100%

This parameter sets the relationship between the dry signal and the level of the effect in this Effect Block.

Whammy

The Whammy effect allows you to control the pitch of an added voice with an external Expression pedal. For Factory presets including the Whammy effect, the Expression pedal connected to the Pedal Input automatically controls the Pitch parameter, i.e. it acts as a Whammy Pedal.

Pitch

Range: 0 to 100%

This parameter sets the amount of pitch shift relative to the Range setting. A connected pedal adjusts this parameter.

Dir – Direction

Range: Up – Down

This parameter determines whether the attached Expression pedal should increase or decrease pitch when moved in either direction.

Per default, pitch is up when the pedal is at “toe down position”, i.e. this is the “Up” position.

Range

Range: 1-Oct/2-Oct

This parameter sets the range of the pitching effect. Select 2-Oct for an extreme and 1-Oct for the more commonly used, subtle Whammy effect.

EFFECTS - PITCH

Octaver

The Octaver gives you an additional voice with a fixed pitch distance of either one or two octaves above or below the Input note.

Dir - Direction

Range: Up or Down

This parameter sets whether the added voice should be above or below the input note.

Range

Range: 1 or 2 octaves

This parameter sets the interval of the added voice. Use the Direct parameter to determine whether the added voice should be above or below the Input signal.

Mix

Range: 0 to 100%

This parameter sets the relationship between the dry signal and the level of the effect in this Effect Block.

Pitch Shifter

The NOVA System's Pitch Shifter gives you two voices, each with a fixed pitch distance to the input note. The maximum range for this effect is +/- one octave. The signal processing within the NOVA System is so fast that you will never notice any "searching" for notes as with many older pitch shifting units or octaver stomp boxes.

Voice 1

Range: -1200 to 1200 Cent

This parameter specifies the pitch of the first voice. As 100 Cent equal 1 semitone, you can select any interval between two octave below the Input pitch to two octaves above it.

Voice 2

Range: -2400 to 2400 Cent

This parameter specifies the pitch of the second voice. As 100 cent equal 1 semitone, you can select any interval between two octaves below the Input pitch to two octave above it.

Pan 1

Range: -50 to 50

This parameter sets the stereo position of the first voice.

Pan 2

Range: -50 to 50

This parameter sets the stereo position of the second voice.

Delay 1

Range: 0 to 350ms

This parameter sets the delay time for the first voice.

Delay 2

Range: 0 to 350ms

This parameter sets the delay time for the second voice.

FB1

Range: 0 to 100%

This parameter determines how often the first voice will be repeated by the delay.

FB2

Range: 0 to 100%

This parameter determines how often the second voice will be repeated by the delay.

Mix

Range: 0 to 100%

This parameter sets the relationship between the dry signal and the level of the effect in this effect block.

OutLev

Range: -100 to 0 dB

This parameter sets the output level for each of the voices.

EFFECTS - PITCH

Intelligent Pitch Shifter

The NOVA System Intelligent pitch-shifter is a 2 voice pitch-shifter that allows you to play harmonies within a variety of scales in any key. The range of the voices range from minus 13 scale-steps below to 13 scales steps above which equals +/- one octave plus a diatonic sixth.

Key

To allow the intelligent pitch-shifter to generate the correct voices it is necessary to enter which key you are playing in. Keys are listed as: C, C#, D, D#, E, F, F#, G, G#, A, A#, and B.

Scale

With the scale parameter you set the type of scale you intend to play. NOVA System covers the following scales-types:

Label	Full name	Scale steps
Ionian	Ionian	1,2,3,4,5,6,7
Dorian	Dorian	1,2,b3,4,5,6,b7
Phrygi	Phrygian	1,b2,b3,4,5,b6,b7
Lydian	Lydian	1,2,3,#4,5,6,7
Mixoly	Mixolydian	1,2,3,4,5,6,b7
Aeolia	Aeolian	1,2,b3,4,5,b6,b7
Locria	Locrian	1,b2,b3,4,b5,b6,b7
PntMin	Pentatonic minor	1,b3,4,5,b7
PntMaj	Pentatonic major	1,2,3,5,6
Blues	Blues	1,b3,4,b5,5,b7
DimWhl	Diminished whole	1,2,b3,4,b5,b6,6,7
Whole	Wholetone	1,2,3,#4,#5,b7
HrmMin	Harmonic minor	1,2,b3,4,5,b6,7

Voice 1-2

Range: -13 to Unison to 13

The intelligent pitch-shifter can add two voices within the selected scale. The pitch-shifter automatically calculates the correct interval according to the played note, selected scale type and key.

Level 1-2

Range: -100 to 0 dB

Sets the individual levels of the two voices.

Pan Position 1-2

Range: -/+50

Controls the panning position of each of the two voices. 0 is center position. By panning the voices you can achieve a very wide spread sound.

Delay 1-2

Delay range: 0-50ms

To get a natural sounding result it is obvious to simulate that no two guitarist would play notes precisely at the same time. To simulate this you can delay the harmony voices slightly. Just 10-20ms of delay will give in a smooth and natural sounding result.

Mix

Range: 0 to 100%

Sets the overall mix between the dry and processed signal.

OutLev – Out Level

Range: -100 to 0 dB

This parameter sets the overall output level of this effect.

Delay – Introduction

The NOVA System offers not only standard delay types but also a few new ones. We believe that the following types should cover all your delay needs:

- **Clean**
- **Analog**
- **Tape**
- **Ping Pong**
- **Dynamic Delay**
- **Dual Delay**

All delays feature true “spillover” – meaning the repeats of the delay can ring out when you change presets.

The tempo of the delay can be defined in relation to a Global tempo, which can be tied to an incoming MIDI clock.

Common Parameters – Delay

The following parameters are identical for all delay types. Parameters specific to certain delays are described in the relevant sections.

Delay Time

Range: 0 to 1800 ms

This parameter sets the time between the delay repeats. This is also known as the “length” of the delay.

Tempo

Range: Disable, 1 to 1/32T (T= Triplet & D= Dotted)

When set to any value between 2 and 1/32T, the NOVA System’s global tempo is subdivided according to this setting. When set to “Ignore”, the speed set by the Speed parameter is used instead.



The Tap Master parameter – located in the Utility menu – specifies whether the Global tempo or the tempo set by the Speed parameter in each preset should be used at preset change.

Fb – Feedback

Range: 0 to 100%

This parameter sets the amount of feedback from the output of the effect back to its input. Use the Feedback parameter to set how many repeats of the signal you would like to have.



Please use high settings with extreme caution. Due to the spillover feature of the NOVA System, there is no way to immediately cut off the delay when you get an internal feedback at settings above 100%. If you do get internal feedback, either switch to a different delay type or to a different preset that uses the delay, two times in succession.

LoCut – Feedback LoCut

Range: 20 Hz to 20 kHz

Use this parameter to attenuate the frequencies below a given frequency.

As with the Feedback Hi-Cut parameter, the delays may blend in more nicely with the overall sound if you “thin out” the effect at the low end.

HiCut – Feedback Hi-Cut

Range: 20 Hz to 20 kHz

With digital technology, every delay can be a precise reproduction of the Input signal. But especially with long delay times, this is not always desirable, as these pristine delays may disturb the original signal and result in a “washed-out” sound. To compensate for this, use the hi-cut filter, thereby emulating analog or tape style delay units. The Feedback Hi-Cut parameter attenuates the frequencies over the set frequency, resulting in a more “analog” sound that in many cases that will blend in better with the overall sound.

Mix

Range: 0 to 100%

This parameter sets the relationship between the dry signal and the level of the effect in this effect block.

EFFECTS - DELAY

Clean

The Clean Delay effect is the most simple and basic delay type in the NOVA System. It comprises a single delay line with all the common parameters.

All Common Parameters

Please refer to the section “Delay – Introduction” for a description of this Delay’s parameters.

Analog

This delay simulates analog style delays, including the clipping sound that occurs when the feedback parameter is yanked past the 100% point. Try experimenting with a high feedback level combined with high and low cut filters.

In addition to the “common” parameters described in the introduction of the delay section, this delay has the following parameters:

Drive

Range: 0 to 24 dB

Use this parameter to simulate the slight deterioration of the delay repeats due to clipping.

Tape

This delay includes the “Drive” parameter that can be used to add the saturation to the delay repeats often associated with Tape delays.

In addition to the “common” parameters described in the introduction of the delay section, this delay has the following parameters:

Drive

Range: 0 to 24 dB

The higher you set the Drive parameter, the more distorted the repeats become. The “drive” simulated by this effect has a very “analog” feel.

Ping Pong

The Ping Pong delay causes the delay to alternate between the left and right channels, resulting a very nice stereo feel. Use the Width parameter to determine how “stereo” you want this effect to be.

In addition to the “common” parameters described in the introduction of the delay section, this delay has the following parameters:

Width

Range: 0 to 100%

The Width parameter determines how far the left and right repetitions should spread from the center.

Dynamic Delay

The Dynamic Delay is a feature that was initially introduced in the well-recognized TC 2290. It allows the dynamics of the Input level to actively alter the delay output level, which leaves the source signal clear and undisturbed while you play. The Dynamic Delay delicately complements your performance.

Use the Sense parameter to determine when the delays should re-surface. Use the Offset parameter to widen the stereo image.

In addition to the “common” parameters described in the introduction of the delay section, this delay has the following parameters:

Offset

Range: 0 to 200

This parameter offsets the delay repeats in the right channel only. For a “wide” stereo effect, the delay in the two channels should not occur at exactly the same time. For a “wide” effect, a few milliseconds should do the trick. Using more than that will give you anything from a generous slap-back effect on the repeats to more extreme effects.

Sense – Sensitivity

Range: -50 to 0 dB

The sensitivity parameter determines how soon the delay repeats should become audible in relation to the Input signal level. This parameter acts a threshold between your guitar signal and the delay repeats.

Damp

Range: 0 to 100 dB

As explained in the introduction, the Dynamic Delay attenuates the delay repeats level based on the present Input. The Damp parameter sets the amount of attenuation.

Rel – Release

Range: 20 to 1000 ms

Determines how fast the attenuation of the delay repeats is released.

Dual Delay

This true Dual Delay lets you set two independent delay taps, each with its own Tempo parameter, High and Low cut, as well as a “Pan” parameter.

In addition to the “common” parameters described in the introduction of the delay section, this delay has the following parameters:

Pan1 & Pan2

Range: 50L to 50R

Sets the panning position of the delay repeats for delay lines 1 and 2.

FX Mute - Spill-over

The FX Mute parameter determines how the Reverb and Delay effects should behave when changing between presets and when bypassing one of these effects.

The FX Mute parameter is found in the utility menu.

Soft:

Delay and Reverbs will “ring out”

Delays have true spillover, meaning that if you e.g. have a long delay time and the FX Mute parameter is set to “Soft” the delays will continue even if you change to a preset that holds completely different delay settings.

Reverbs can also spill over at preset change but will use the settings in the new preset.

Hard:

Delay and Reverbs will mute.

EFFECTS - REVERB

Reverb Types

The NOVA System features four different reverb classics. All types have the same editable parameters, but the reverbs' characteristics vary.

Spring

The Spring algorithm is designed to reproduce the sound of old spring reverbs, such as the ones used in vintage guitar amps.

Hall

The Hall algorithm simulates a rather large hall and preserves the natural characteristics of the source material. Excellent when you strive for a discrete reverb with medium to long decay times.

Room

The Living Room type simulates a relatively small, well furnished room. In such a room, many reflections are absorbed by soft materials, and the source signal is reflected and sustained mainly from the walls.

Plate

Before the digital era, either reverberating springs or large metallic plates were used to create reverb effects. Plate reverbs sound diffuse and bright. They can be used to make the processed signal "stand out", rather than blend naturally.

These brief introductions should only give you a hint in terms of choosing the right one for a given application. Take some time to listen to the different types, experiment and don't be afraid to be innovative!

Common Reverb Parameters

Decay

Range: 0.1 to 20 seconds

The Decay parameter determines the length of the Reverb Diffuse Field. The length is defined as the time it takes for the Diffuse Field to decay approximately by 60 dB.

PreDly – Pre Delay

Range: 0 to 100 ms

This parameter defines a short Delay placed between the direct signal and the reverb diffuse field. Use pre delay to keep the source material clear and undisturbed from the reverb diffuse field arriving shortly after.

Shape

Range: Round, Square, Curved

The shape of the simulated room is of great importance to the reverb characteristics. Try the various shapes.

Size

Range: Small, Medium or Large

Though the decay time can be altered from 0.1 to 20 seconds on all reverb types, selecting a predefined (room) size may get you closer to the sound you desire. To achieve a natural sounding emulation of a big room with long decay, select "Large". Use the medium and small settings accordingly for simulations of smaller rooms. Again: - building the perfect guitar sound is not always about doing the most obvious. You may find cool settings by swimming against the stream.

Hi Col & Lo Col – (High Color/Low Color)

Hi Color range: Wool, Warm, Real, Clear, Bright, Crisp and Glass.

Lo Color range:

Thick, Round, Real, Light, Tight, Thin, NoBass

These parameters give you six variations of the reverb's low and high frequency ranges.

The two Color parameters can really change the characteristics and style of the reverb – from “dark” and “ambient” to “crisp” and “bright”.

Hi Lev & Lo Lev – (High Level/Low Level)

Range: -25 to 25

Use the Hi Lev and Lo Lev parameters to emphasize or attenuate the selected Hi and Lo Color types.

Early

Range: -100 to 0 dB

This parameter sets the level of the reverb's initial reflections (early reflections).

RevLev – Reverb Level

Range: -100 to 0 dB

This parameter sets the level of the reverb's diffuse field.

Diff – Diffuse

Range: -25 to 25

With this parameter, you can fine-tune the density of the reverb's diffuse field. It is set automatically when you select a decay time and allows you to reduce flutter in the diffuse field to an absolute minimum.

Mix

Range: 0 to 100%

This parameter sets the relationship between the dry signal and the level of the effect in this effect block.

TECHNICAL SPECIFICATIONS

Analog Inputs

Connectors, balanced:	¼" phone jack
Impedance - Balanced/Unbalanced	Line: 21/13 kOhm
Line Input Level @ 0 dBFS:	24 dBu to 0 dBu
Line Sensitivity @ 12 dB headroom:	12 dBu to -12 dBu
Drive Input Level @ 0 dBFS:	18 dBu to -6 dBu
Drive Sensitivity @ 12 dB headroom:	6 dBu to -18 dBu
THD:	< -100 dB (0.001 %) @ 1 kHz
Crosstalk:	< -85 dB, 20 Hz to 20 kHz
A to D Conversion:	24 bit, 128 x oversampling bitstream

Analog Outputs

D to A Conversion:	24 bit, 128 x oversampling bitstream
D to A Delay:	0.63 ms @ S.R.= 48 kHz
Connectors, balanced:	¼" phone jack
Output Impedance:	40 Ohm
Max. Output Level (Balanced/Unbalanced):	20 dBu/14 dBu, R-load = 1200 Ohm
Output Range:	20 dBu / 14 dBu / 8 dBu / 2 dBu
Dynamic Range:	> 104 dB, 20 Hz to 20 kHz
THD:	< -98 dB (0.0013 %) @ 1 kHz
Frequency Response:	+0/-0.3 dB, 20 Hz to 20 kHz

EMC

Complies with:	EN 55103-1 and EN 55103-2 FCC part 15, Class B, CISPR 22, Class B
----------------	--

Safety

Certified to:	IEC 65, EN 60065, UL6500 and CSA E60065 CSA FILE #LR108093
---------------	---

Environment

Operating Temperature:	32° F to 122° F (0° C to 50° C)
Storage Temperature:	-22° F to 167° F (-30° C to 70° C)
Humidity:	Max. 90 % non-condensing

Control Interface

MIDI:	In/Out/Thru: 5 Pin DIN
Pedal:	1/4" phone jack

Supplementary

Display:	24x 2 character LCD
Dimensions:	11.2" x 3.5" x 10.25" (284 x89 x 267 mm)
Weight:	4.1 lb. (1.85 kg)
Mains Voltage:	100 to 240 VAC, 50 to 60 Hz (auto-select)
Power Consumption:	<15 W
Warranty Parts and labor:	1 year

Due to continuous development, these specifications are subject to change without notice.