

tc electronic



FLASHBACK X4 DELAY & LOOPER

User Manual

Table of contents

Introduction	1	Dynamic	8
Important safety instructions	2	2290	8
Warning	2	2290 w/mod	8
Service	2	Slap	8
EMC/EMI	3	Lofi	8
For customers in Canada	3	Ping Pong	8
Unpacking and setting up	4	1 – Audio inputs and outputs	9
Ready...	4	Audio inputs	9
Set...	4	Audio outputs	9
Play!	4	2 – Expression pedal input	10
Setup example: regular mono signal path	5	Choosing an expression pedal	10
Setup example: amplifier effect loop	6	Assigning delay parameters and parameter ranges to an expression pedal	10
Delay types	7	Resetting parameters and parameter ranges	11
Tape	7	3 – Power input	12
Tube	7	4 – USB jack	12
Space	7	5 – MIDI IN / MIDI THRU jacks	12
Analog	7	MIDI IN jack	12
Analog w/mod	7	MIDI THRU jack	12
Reverse	7	6 – Delay type selector	13

The TonePrint concept	14	14 – TAP footswitch	23
Transferring TonePrints to the pedal	15	Using the Looper module	24
Transferring TonePrints to the pedal via USB	15	Using the delay in Looper mode	24
Transferring TonePrints to the pedal by beaming	15	Recording a loop	25
7 – DELAY TIME knob	16	Playing a loop continuously	25
8 – Subdivision selector switch	16	Stopping loop playback immediately	25
9 – FEEDBACK knob	17	Playing a loop once	25
10 – DELAY LEVEL knob	17	Stopping loop playback at the end of the loop	25
11 – LOOPER/DELAY switch	18	Undoing a loop recording	26
12 – LOOPER LEVEL knob	19	Deleting a loop completely	26
13 – Preset footswitches (A / B / C)	20	Loops cannot be stored	26
Recalling a preset	20	Bypass modes	27
Factory presets	20	True Bypass mode	27
Preset off / Bypass mode	20	Buffered Bypass mode	27
Storing presets	21	Kill-Dry feature	28
Delay spill-over	21		
TonePrints and presets	22		

Introduction

Congratulations on the purchase of your new Flashback X4 Delay & Looper.

Flashback X4 Delay & Looper builds on the success of TC's popular Flashback pedal. It provides 12 delay types in pristine TC Electronic quality, tap tempo and three preset slots for an instant classic.

Flashback X4 Delay & Looper is TonePrint-enabled, allowing you to load up to four signature Flashback delay settings as created and used by the biggest names in rock – from Steve Morse and Doug Aldrich to Joe Perry, Steve Stevens and many, many more.

We believe that Flashback X4 Delay & Looper offers the best sounding delay as well as enormous flexibility within a compact delay pedal – and we are certain that you will feel the same.

About this manual

This manual will provide you with a quick overview of how to get rocking fast as well as an in-depth look at the pedal's more advanced features. *Happy reading!*

Please note: TC Electronic reserves the rights to change the contents of this manual at any time.

The latest revision of this manual can be downloaded from <http://www.tcelectronic.com/manuals.asp>

This is version *1.0* of the Flashback X4 Delay & Looper manual.

If you still have questions after reading this manual, please use

TC Electronic Support:

<http://support.tcelectronic.com/>

Important safety instructions

- Read these instructions.
- Keep these instructions.
- Heed all warnings.
- Follow all instructions.
- Do not use this apparatus near water.
- Clean only with dry cloth.
- Do not block any ventilation openings. Install in accordance with the manufacturer's instructions.
- Do not install near heat sources such as radiators, heat registers, stoves, or other apparatus (including amplifiers) that produce heat.
- Only use attachments/accessories specified by the manufacturer.
- Refer all servicing to qualified service personnel. Servicing is required when the apparatus has been damaged in any way, such as power supply cord or plug is damaged, liquid has been spilled or objects have fallen into the apparatus, the apparatus has been exposed to rain or moisture, does not operate normally, or has been dropped.

Warning

To reduce the risk of fire or electrical shock, do not expose this equipment to dripping or splashing and ensure that no objects filled with liquids, such as vases, are placed on or near the equipment.

Do not install this product in a confined space.

Service

All service must be performed by qualified personnel.

Caution

You are cautioned that any change or modifications not expressly approved in this manual could void your authority to operate this equipment.

When replacing the battery follow the instructions on battery handling in this manual carefully.

EMC/EMI

This equipment has been tested and found to comply with the limits for a Class B Digital device, pursuant to part 15 of the FCC rules.

These limits are designed to provide reasonable protection against harmful interference in residential installations. This equipment generates, uses and can radiate radio frequency energy and, if not installed and used in accordance with the instructions, may cause harmful interference to radio communications. However, there is no guarantee that interference will not occur in a particular installation. If this equipment does cause harmful interference to radio or television reception, which can be determined by turning the equipment off and on, the user is encouraged to try to correct the interference by one or more of the following measures:

- Reorient or relocate the receiving antenna.
- Increase the separation between the equipment and receiver.
- Connect the equipment into an outlet on a circuit different from that to which the receiver is connected.
- Consult the dealer or an experienced radio/TV technician for help.

For customers in Canada

This Class B digital apparatus complies with Canadian ICES-003.

Cet appareil numérique de la classe B est conforme à la norme NMB-003 du Canada.

Unpacking and setting up

Ready...

The Flashback X4 Delay & Looper box should contain the following items:

- 1 Flashback X4 Delay & Looper pedal
- 1 TC 9V DC power supply with interchangeable plugs
- 2 rubber feet for “non-velcro” pedal board mounting
- 1 USB cable for transferring TonePrints from the computer to the pedal and updating the pedal firmware
- 1 TC Electronic sticker
- 1 leaflet about TC’s guitar FX product range.

Inspect all items for signs of transit damage. In the unlikely event of transit damage, inform the carrier and supplier.

If damage has occurred, keep all packaging as it can be used as evidence of excessive handling force.

Set...

- Attach the plug applicable to your region to the power supply. Connect the power supply to the 9V jack on the back of the Flashback X4 Delay & Looper and plug the power supply into a power outlet.
- Make sure the LOOPER/DELAY switch is set to “Delay”.
- Connect your instrument to the INPUT MONO jack on the back of the pedal (see page 5).
- Connect the OUTPUT MONO jack on the back of the pedal to your amplifier.

Play!

Setup example: regular mono signal path

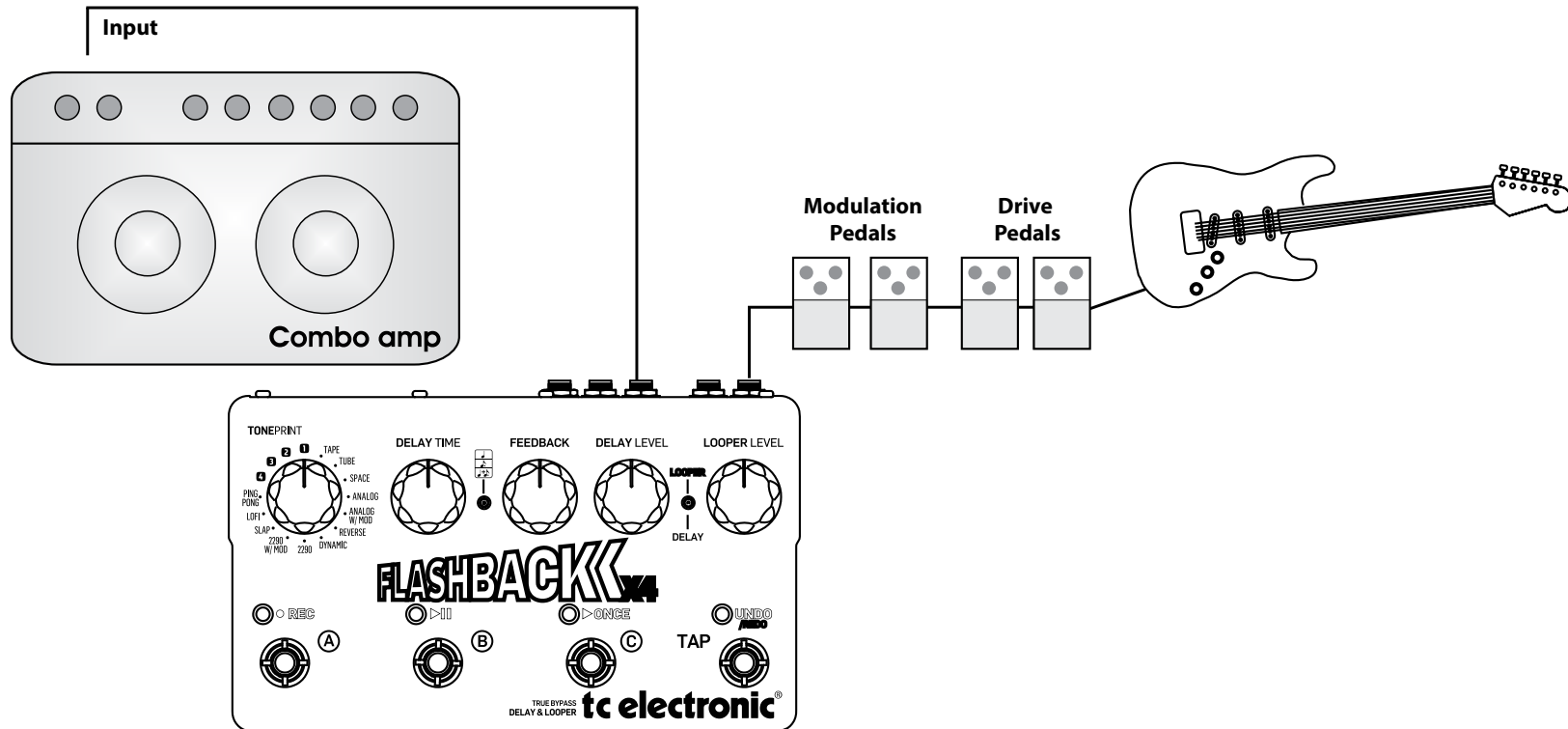

Setup example: amplifier effect loop

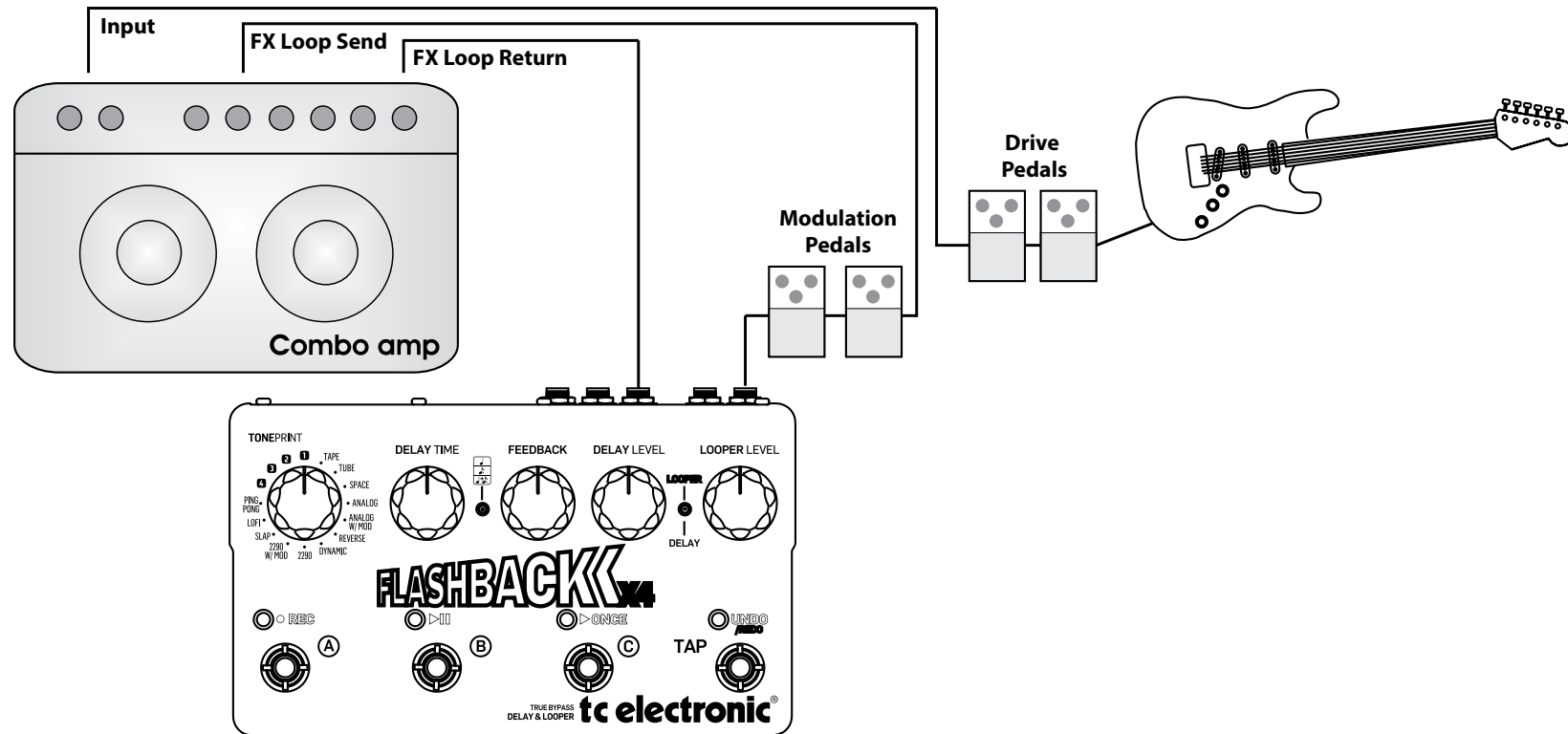

Delay types

“OK... So what does this thing do?”

“Glad you asked. First and foremost, the Flashback X4 Delay & Looper is a top-notch delay unit – so let’s talk delays!”

TAPE

Who doesn’t love the smooth sound of an old tape echo machine? The “Tape” setting makes for an overall great starting point with its mellow and “warbling” sound.

TUBE

This delay type has been tweaked to sound like an old tube tape echo – much like the “Tape” setting, but with a bit more warmth.

Use this setting if you want your fans to check the stage for hidden vintage gear...

SPACE

It’s hard *not* to like the luscious tape sound of the original Roland® Space Echo*. The “Space” setting instantly gives you rich echo sounds with a bit of Space Echo* *mojo*.

ANALOG

This is as close as you can get to the charming nature of an old analog transistor bucket-brigade delay without buying the real thing! With every repeat you get more of that old-school “fade to grey” vibe.

ANALOG W/MOD

Take a trip down Memory Lane with this rich and larger-than-life sounding delay. “Analog w/mod” will definitely spice up your sound.

REVERSE

If you’ve been around for some time, you know the drill: Record a guitar part on tape. Flip the tape over. Play it back. This is a classic effect made famous by guitar legends such as Jimi Hendrix – and although it’s kind of “old school”, the reverse effect still seems to inspire people to try out new things.

Try this:

Turn the FEEDBACK knob all the way down to hear only the reversed signal.

DYNAMIC

Imagine you had someone turn *up* the volume of your delay pedal as soon as you stop playing for a second... and turn it *down* again when you resume playing.

Why not let the Flashback X4 Delay & Looper be that someone? That's what the "Dynamic" delay type does. It's especially useful for fast solo parts where you don't want the delay repetitions interfering with your playing.

2290

Once upon a time... (i.e., back in 1985) TC Electronic released the 2290 Dynamic Digital Delay. It set the bar for professional delays for years to come and is still held in high regard among delay enthusiasts.

Use the "2290" setting for the most crisp and clean delay you can imagine. This *is* the standard.

2290 W/MOD

Take the 2290's pristine sound, send it through three (!) chorus pedals... *et voilà*. If you're into the sound of The Edge, you don't want to miss this setting.

Oh, and while you're at it, try playing around with the SUBDIVISION SELECTOR Switch. 

SLAP

A delay type for all things *country* – but you can also use this for many other genres.

Use this setting to get your rockabilly on and pay homage to the rich *staccato* heritage of Brian Setzer, Chet Atkins and Scotty Moore, or as an alternative to reverb.

LOFI

Fed up with hi-fi? Try the "Lofi" setting to get that *dirty* feel.

From punk to rock – play around with the knobs, but no matter what you do: It ain't gonna sound pretty.

PING PONG

Like the ball in the eponymous game, the delay repeats jump from left to right (provided you're using both outputs for a stereo signal). The effect is really wide.

Ping Pong is a lot of fun to play around with in stereo – but it sounds great in mono, too.

* All product names are trademarks of their respective owners, which are in no way associated or affiliated with TC Electronic. These product names and descriptions are provided for the sole purpose of identifying the products that were studied during product development.

I – Audio inputs and outputs

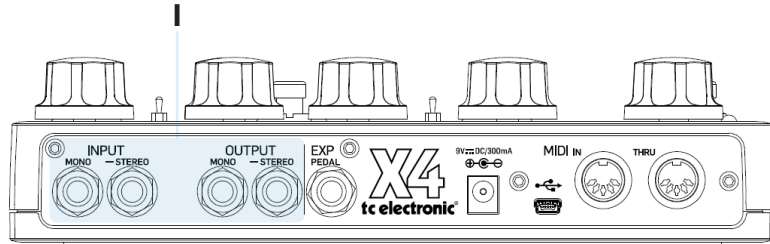

The Flashback X4 Delay & Looper is equipped with ¼" input and output jacks.

Audio inputs

- If your signal source is *mono*, connect it to the INPUT MONO jack.
- If your signal source is *stereo*, connect the cable carrying the *left* signal component to the INPUT MONO jack and the cable carrying the *right* signal component to the INPUT –STEREO jack.

Audio outputs

- If the next device in the signal chain has a *mono* input, connect the Flashback X4 Delay & Looper’s OUTPUT MONO jack to the other device’s input.
- If the next device in the signal chain has *stereo* inputs, connect the Flashback X4 Delay & Looper’s OUTPUT MONO jack to the *left* input and the OUTPUT –STEREO jack to the *right* input of the device.

“So how do I configure the Flashback X4 for mono or stereo operation? What if I want mono input and stereo out or...”

“Stop worrying – start rocking!”



You don’t need to worry about mono/stereo configuration issues. The Flashback X4 Delay & Looper uses auto-sensing technology to detect if you are using it in mono or stereo – both on inputs and outputs.

2 – Expression pedal input

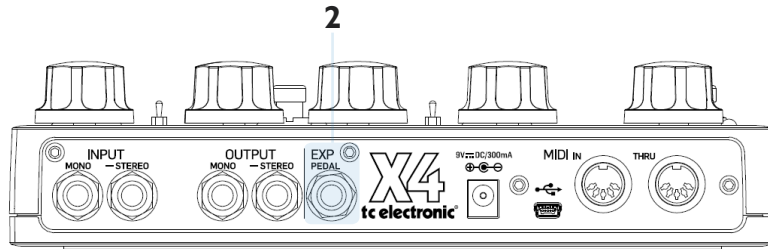

The Flashback X4 Delay & Looper allows you to connect an expression pedal (optional/not included).

Once you have connected and configured an expression pedal, you can use it to control one or more of the following parameters:

- Delay Time
- Feedback Level
- Delay Level.

These parameters will be explained later in this manual.

You can define...

- which *parameter(s)* you want to control with an expression pedal and
- the *parameter range* to control.

Choosing an expression pedal

For use with the Flashback X4 Delay & Looper, you'll want to use a *25 kOhm linear pot expression pedal*.

Please note that a standard guitar *volume pedal* has a *250 kOhm logarithmic pot* and cannot be used as an expression pedal for the Flashback X4 Delay & Looper.

If you already own an expression pedal and you are not sure if you can use it with the Flashback X4 Delay & Looper, please ask your local vendor or get in touch with [TC Support](#).

Assigning delay parameters and parameter ranges to an expression pedal

You can control any combination of the Delay Time, Feedback Level and Delay Level parameters with an external expression pedal.

To set up parameters and parameter ranges, proceed as follows:

- Connect an expression pedal to the EXP PEDAL jack on the Flashback X4 Delay & Looper.
- Switch on the Flashback X4 Delay & Looper.
- Choose a preset (A, B or C) on the Flashback X4 Delay & Looper.
The LED of the selected preset will light up.
- Set the expression pedal to the *maximum* position.

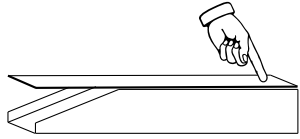

- Set the knobs for the parameters you want to control to the desired *maximum* values.
- Set the expression pedal to the *minimum* position.

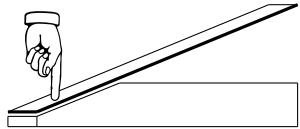

- Set the knobs for the parameters you want to control to the desired *minimum* values.
- Press and hold the footswitch for the preset to store these settings.

Resetting parameters and parameter ranges

To reset the parameters and parameter ranges assigned to a Flashback X4 Delay & Looper preset, proceed as follows:

- Connect an expression pedal to the EXP PEDAL jack on the Flashback X4 Delay & Looper.
- Switch on the Flashback X4 Delay & Looper.
- Choose the respective preset (A, B or C) on the Flashback X4 Delay & Looper.
- Set the expression pedal to the *maximum* position.

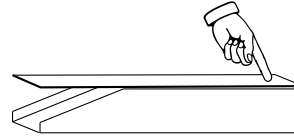

- Press and hold the footswitch for the preset.

3 – Power input

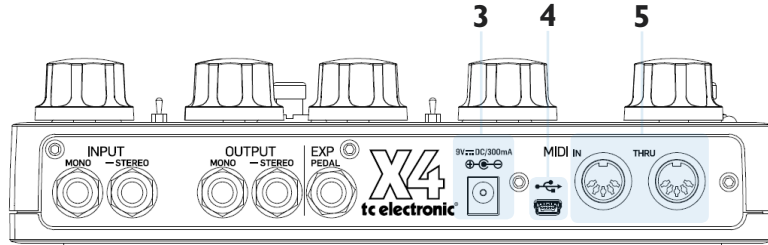

Type: standard 5.5/2.1 mm DC plug, centre negative (supplied).

To power up the pedal, connect the power supply that came with the Flashback X4 Delay & Looper to the power input jack.

You may also use another 9V or 12V power supply, as long as it provides 300 mA or more. Use power supplies with isolated outputs to minimize hum.

4 – USB jack

You can download new TonePrints from the TC website to your computer and transfer them to your pedal.

Use the Mini-B to Type A USB cable that came with the pedal to connect the Flashback X4 Delay & Looper to a computer.

For more on downloading and using TonePrints, see

<http://www.tcelectronic.com/toneprint>

5 – MIDI IN / MIDI THRU jacks

These are standard MIDI (Musical Instrument Digital Interface) connectors.

MIDI IN jack

Connect a computer/DAW (or another device generating a MIDI Clock signal) to the MIDI IN jack to control the pedal's delay tempo.

An incoming MIDI Clock signal will override the settings of the pedal's own Delay Time knob. However, the Subdivision Selector switch still defines the actual *note values* used to generate the delays.

You can also send MIDI Program Change messages from your computer (or another MIDI-capable device) to the pedal to switch between the pedal's three presets.

- Program Change message #001: Recall Preset A
- Program Change message #002: Recall Preset B
- Program Change message #003: Recall Preset C

The Flashback X4 Delay & Looper is receiving MIDI messages on *all* MIDI channels (MIDI Omni Mode).

MIDI THRU jack

To forward the incoming MIDI signal to another MIDI-equipped device, connect the MIDI THRU jack of the Flashback X4 Delay & Looper to the MIDI Input of another MIDI device.

6 – Delay type selector

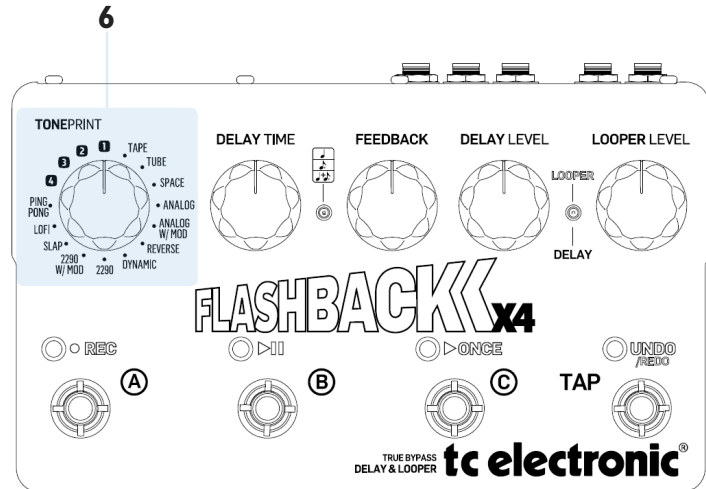

Use the DELAY TYPE SELECTOR to choose the type of delay you want to work with. The Flashback X4 Delay & Looper offers a wide range of delays – from classic tape delays to the pristine sound of a TC 2290.

The delay types are described on page [7](#).

When you choose a delay type, the chosen delay type will “pick up” the current positions of the delay control knobs (for example DELAY TIME). However, if you choose a preset and turn one of the delay control knobs, nothing will change except for that one, specific parameter.

The slots “1”, “2”, “3” and “4” of the Delay Type Selector are “placeholders” for TonePrints. The Flashback X4 Delay & Looper comes equipped with the following default TonePrints:

- Delay TonePrint by **Steve Morse**
- Basic Delay TonePrint by **Bumblefoot**
- Basic Delay TonePrint by **Doug Aldrich**
- Synth Delay by **James “Munky” Shaffer**

The TonePrint concept is explained in detail on page [14](#).

The TonePrint concept

“So what exactly is this TonePrint thing?”

“Amazing, that’s what it is! Allow us to explain…”

When you look at your pedal, you’ll only see a few knobs and switches. However, they actually control a large number of internal parameters.

TC has defined the relationship between each knob and all the parameters “under the hood”. But wouldn’t it be cool to have guys like Steve Stevens, Scott Ian or Paul Gilbert (i.e., some of the world’s leading guitar players) virtually rewire these controls, defining what should happen behind the scenes?

This is exactly what TonePrint does.

We work with top guitar players who explore a pedal’s hidden tonal potential, redefining the controls and creating their personal TonePrints.

TC is making these custom TonePrints available to you. Uploading them to your pedal is really easy, you can even change them as often as you like, and the best part: They’re totally **free**.

Transferring TonePrints to the pedal

“So how do I load new TonePrints into my pedal?”

“Use USB, Luke – or beam it.”

Transferring TonePrints to the pedal via USB

- Go to www.tcelectronic.com/toneprint.
- Select your TC product in the “TonePrint by product” sidebar.
- Download a TonePrint you’d like to try.
- Connect your TC pedal and your computer using the USB cable that came with the pedal.
- Turn the Delay Type Selector knob to the TonePrint Slot (“1”, “2”, “3” or “4”) that you want to use for the new TonePrint and turn on the delay.
- Turn your TC pedal on.
- Launch the TonePrint application you downloaded and follow the on-screen instructions. It’s quick and easy.

Transferring TonePrints to the pedal by beaming



For all you iPhone and Android users out there, we created the TonePrint App. iPhone users can download it from Apple’s App Store, Android users will find it on Google Play.

- Launch the app on your smartphone and find the TonePrint you want to use.
- Plug your guitar or bass into your TC pedal.
- Turn the Delay Type Selector knob to the TonePrint Slot (“1”, “2”, “3” or “4”) that you want to use for the new TonePrint and turn on the delay.
- Turn your TC pedal on.
- Turn up the volume on your instrument and set the pickup selector to one pickup.
- Hold the speaker of your smartphone next to the chosen pickup and touch “Beam to pedal”.

(Or just follow the on-screen instructions on your phone.)

7 – DELAY TIME knob

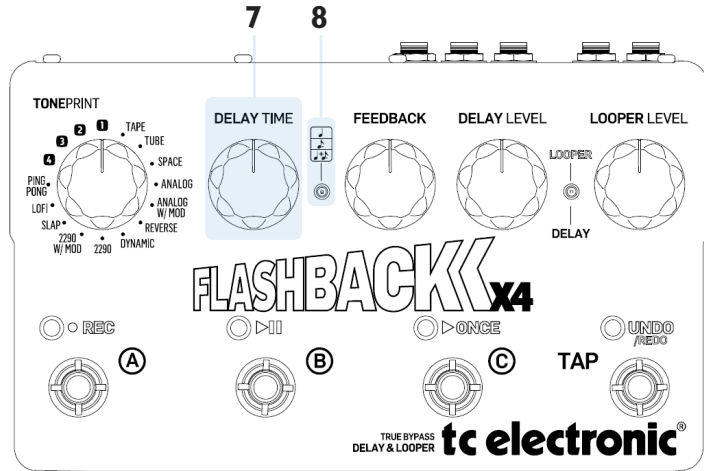

Turn the DELAY TIME knob all the way down for really short repeats. Turn the DELAY TIME knob up until you find your preferred amount of delay time. Turning the DELAY TIME knob all the way up will give you a whopping seven seconds of delay time for most delay types.

The knob is scaled so that you'll be within the most usable range from the *minimum* position to approximately the 3 o'clock position. Turning it beyond this point will give you very high values.

8 – Subdivision selector switch

Use this switch to choose the note intervals that the delay repetitions are based on.

- Top position: quarter notes
- Middle position: dotted eighths
- Bottom position: quarter notes *and* dotted eighths.

9 – FEEDBACK knob

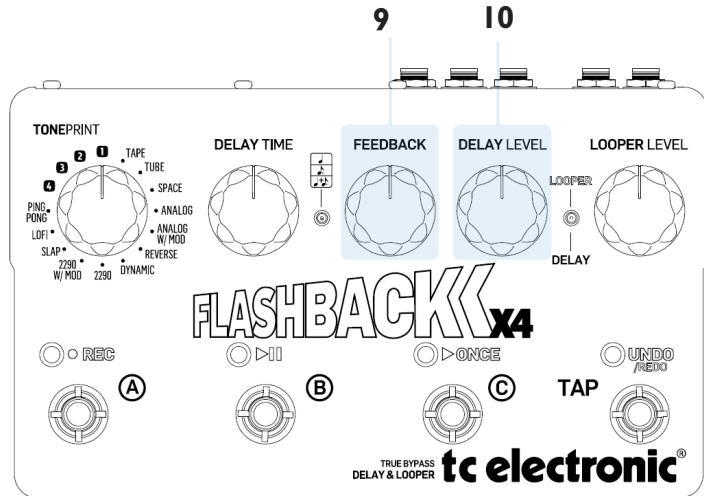

Use the FEEDBACK knob to set the desired numbers of delay repeats. Turning the FEEDBACK knob to the right will give you more delay repeats.

10 – DELAY LEVEL knob

Use the DELAY LEVEL knob to set the desired level of the delay signal. Turning the DELAY LEVEL knob to the right will increase the volume of the delay signal.

Unlike the delay level knobs of some other pedals, the DELAY LEVEL knob of the Flashback X4 Delay & Looper will *not* influence the volume of the *dry* (unprocessed) signal, since we don't want to mess with the original signal from your instrument.

Analog-dry-through allows the analog signal from your guitar to pass through the pedal without being digitized, even when the pedal is turned on. This means absolutely zero latency and no tone coloration.

II – LOOPER/DELAY switch

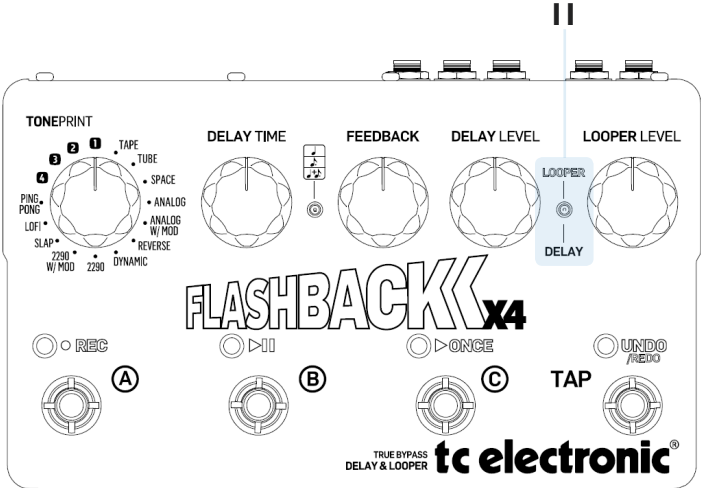

Use this LOOPER/DELAY switch to set the functionality of the footswitches A, B and C.

- When the switch is in the *top* position (“Looper”), the four switches A, B, C and TAP (UNDO/REDO) control the Looper functions.

The Looper module is explained on page [24](#).

- When the switch is in the *bottom* position (“Delay”), the three switches A, B and C can be used to access the Flashback X4’s three presets.

Using presets is explained on page [20](#).

I2 – LOOPER LEVEL knob

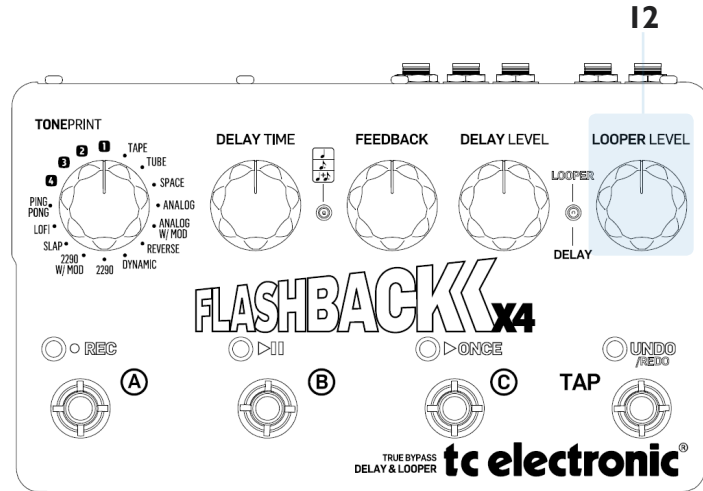

Use the LOOPER LEVEL knob to set the playback volume of the Flashback X4's Looper module.

You can still use the delay effect when using the Looper module. If you do so, use the DELAY LEVEL and the LOOPER LEVEL knobs to balance the volumes of the effect and the audio loop.

13 – Preset footswitches (A / B / C)

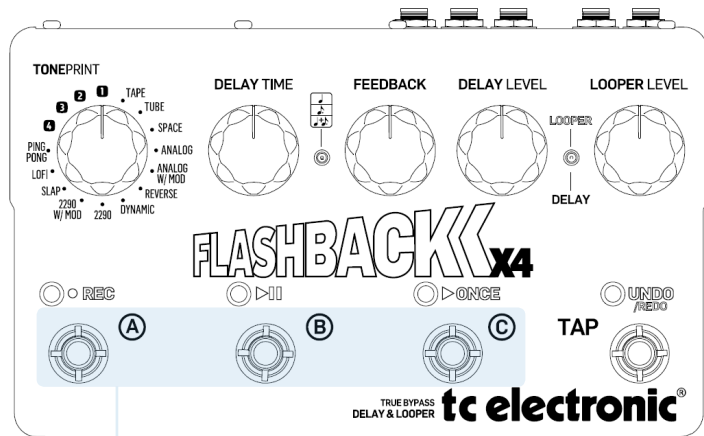

13

When the LOOPER/DELAY switch (see page 18) is in the *bottom* position (“Delay”), the three switches A, B and C can be used to access the Flashback X4 Delay & Looper’s three presets.

When the LOOPER/DELAY switch is in the *top* position (“Looper”), you do *not* have access to presets. Instead, the current positions of the delay knobs apply (see page 24).

Recalling a preset

Press the footswitch corresponding to the preset you want to recall (use). Only one preset can be active at a time.

The LED of the active preset’s footswitch will be lit.

Factory presets

The Flashback X4 Delay & Looper comes with three factory presets, but you can overwrite them with your own favorite settings.

- A** This is an Eric Johnson-style tape echo with somewhere between 2 and 3 repeats.
- B** This is a swirly and big 2290 delay with modulation on the repeats. Great for clean playing and volume swells – or if you’re into U2...
- C** This is a short analog delay that will give your sound a bit more ambience.

Preset off / Bypass mode

When *none* of the three footswitch LEDs are lit, the pedal is in bypass mode, and you will only hear the *dry, unprocessed signal*.

If you have set the internal Kill-Dry dip switch to the “On” position (see page 28) and none of the three footswitch LEDs are lit, no signal will be present at the Flashback X4 Delay & Looper’s output.

Storing presets

When you have selected a preset and you have changed parameters (e.g. the delay time), you may want to store your edited version of the preset.

To store the current delay settings, *press and hold* the footswitch of the currently active (lit) preset slot for circa two seconds.

The LEDs of the TAP footswitch and the selected preset will blink to confirm that the preset has been stored.

Delay spill-over

The Flashback X4 Delay & Looper has two bypass modes: True Bypass and Buffered Bypass. Changing the bypass mode is described on page [27](#).

- When the Flashback X4 Delay & Looper is set to **True Bypass** and you switch off the currently selected preset, the delay will immediately be switched off.
- When the Flashback X4 Delay & Looper is set to **Buffered Bypass** and you switch off the currently selected preset, the delay will be allowed to fade/“ring out”.

“So what is saved as part of a preset?”

“Every delay parameter!”

A preset includes all settings of the Flashback X4 Delay & Looper’s delay module, including the TonePrint (i.e., if the Delay type selector is set to one of the four TonePrint slots).

If you have attached an external expression pedal to the Flashback X4 Delay & Looper (see page [10](#)), the parameters assigned to this expression pedal are stored as part of the preset, too.

TonePrints and presets

When you have stored a preset that is using a TonePrint, you can upload/beam a new TonePrint to that TonePrint slot without affecting the preset. This means that the Flashback X4 Delay & Looper effectively gives you access to *seven* TonePrints, like this:

- Upload or beam four TonePrints to the four TonePrints slots of the Flashback X4 Delay & Looper (see page [14](#)).
- Switch to TonePrint slot 1, adjust delay settings and store the results as Preset A.
- Switch to TonePrint slot 2, adjust delay settings and store the results as Preset B.
- Switch to TonePrint slot 3, adjust delay settings and store the results as Preset C.
- Load four *new* TonePrints into the four TonePrints slots of the delay type selector.

You now have access to *seven* TonePrints – those in the four TonePrint slots and those stored as a part of presets A, B and C.

I4 – TAP footswitch

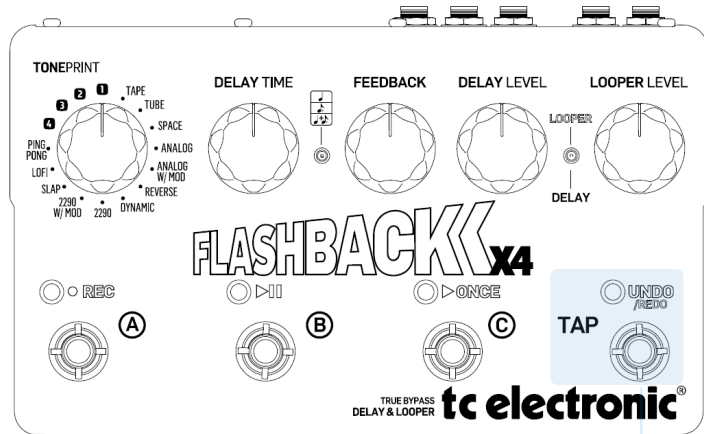

I4

To set the desired delay time, you can tap the TAP footswitch rhythmically. This is an alternative to using the DELAY TIME knob (see page [I6](#)).

Simply tap the TAP footswitch a few times in the current song tempo.

To readjust the tempo when it's a bit off (*of course, the drummer is to blame!*), just tap the TAP footswitch again in the correct tempo.

Please note that the tempo is defined by tapping *quarter* notes. However, if you have set the Subdivision Selector switch to the mid or bottom position, what you will actually hear are delay repeats with dotted eighths and/or quarter notes timing.

Using the Looper module

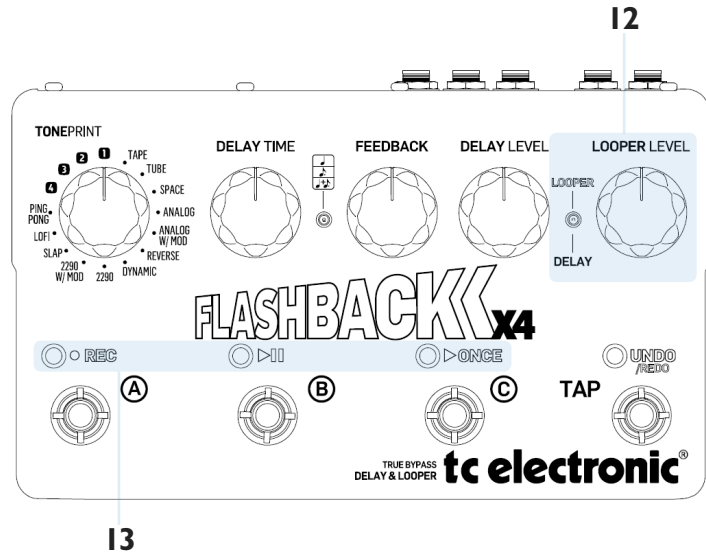

The Flashback X4 Delay & Looper is actually two products in one:

- a delay pedal and
- a looper that allows you to build audio loops by stacking several recordings of what you are playing.

To operate the looper module, set the LOOPER/DELAY switch to the “Looper” position.

Using the delay in Looper mode

You can still use the delay when working with the looper module of the Flashback X4 Delay & Looper. This means that you can record loops with delay effects.

Please note the following differences between Delay mode and Looper mode:

- When the LOOPER/DELAY switch is set to “Delay”, you are usually working with one of the Flashback X4 Delay & Looper’s three delay presets.

In other words: Either preset A, B or C is active, and the LED of the respective footswitch is lit.

When the LOOPER/DELAY switch is set to “Delay” and *no* delay preset is active, the Flashback X4 Delay & Looper is in bypass mode. No effect signal is coming out of the pedal, only the unprocessed signal is being passed through.

- When the LOOPER/DELAY switch is set to “Looper”, you do not have access to presets. Instead, the *current settings* of the delay controls (DELAY TYPE, DELAY TIME, FEEDBACK, DELAY LEVEL) apply. This means that “what you see is what you hear” – and **what you hear is being recorded as part of a loop.**

Accordingly, if you do *not* want to record any delay effects as part of your loops, simply turn the DELAY LEVEL knob down to minimum position.

Recording a loop

- Set the LOOPER DELAY switch to “Looper”.
- To *start recording* a loop, tap the REC footswitch.
- To *stop recording*, tap the REC footswitch again.

You can start and stop recording while the loop is being played back.

As you can change delay settings during loop recording, you can get really creative when stacking your recordings. For example, you could start with a dry bass line (DELAY LEVEL set to minimum), then add some chords with a subtle Tape delay and top it all off with a solo drenched in a luscious “2290 w/mod” delay.

Playing a loop continuously

To *start playback* of a previously recorded loop from the start, press the footswitch with the Playback/Pause symbol.

Playback will continue until you stop it.



Stopping loop playback immediately

To stop playback *immediately*, press the footswitch with the Playback/Pause symbol again.

Playing a loop once

To play back a previously recorded loop just *once*, press the Playback ONCE footswitch.

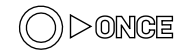

Stopping loop playback at the end of the loop

To stop the playback of the loop *at the end of the loop cycle*, press the Playback ONCE footswitch. The Playback ONCE footswitch will blink until the end of the loop cycle is reached. At this point, playback is stopped.

This is very helpful if you want to end a performance “gracefully” (i.e. right at the end of a loop cycle) without having to worry about hitting the footswitch at just the right moment.

Undoing a loop recording

During loop recording, each new recording is added on top of the loop's previous version. However, if you make a mistake during a recording cycle, you can undo it by pressing the UNDO/REDO footswitch.

If you change your mind, you can press the UNDO/REDO footswitch again to bring back the previously deleted recording cycle.

The undo/redo feature is not only useful for fixing mistakes – it can also be used as a creative tool on stage. Here is a simple example:

- Record a bass line (*loop cycle 1*)
- Record some chords (*loop cycle 2*)
- Record a melody (*loop cycle 3*)
- Tap the UNDO/REDO footswitch to remove the melody. Sing or improvise.
- Tap the UNDO/REDO footswitch again to bring back the previously recorded melody.

Deleting a loop completely

To *delete* your loop recording (not only the last recording cycle) *completely*, press and hold the UNDO/REDO footswitch.

Loops cannot be stored

Please note that while you can store the delay module's settings as presets, *you cannot store loops*. When you switch off the Flashback X4 Delay & Looper, the current loop is erased.

Bypass modes

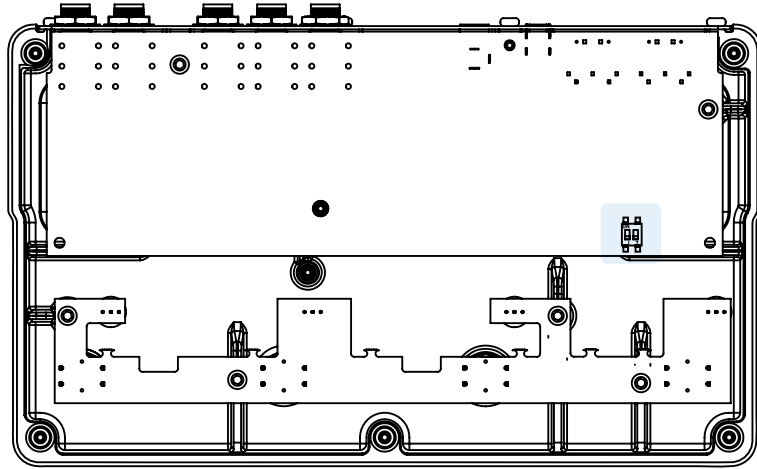

The Flashback X4 Delay & Looper has two bypass modes: **True Bypass** and **Buffered Bypass**. To set the desired mode, you have to open the device.

- Unscrew the back plate and look for the two small dip switches shown in the illustration.

The left dip switch (labelled “1”) switches between *True Bypass* mode (this is the default mode) and *Buffered Bypass* mode.

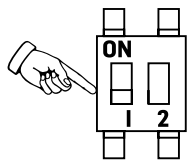

True Bypass

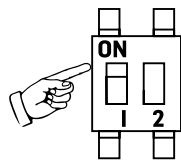

Buffered Bypass

True Bypass mode

...is a hard-wire bypass that ensures that there is absolutely no coloration of tone when the pedal is bypassed.

Using True Bypass on all your effect pedals is the right choice for setups with only a few pedals and relatively short cables before and after the pedals.

Buffered Bypass mode

If you use a long cable between your guitar and the first pedal, or if you use many pedals on your board, or if you use a long cable from your board to the amp... the best solution will most likely be to activate Buffered Bypass mode in the *first* and the *last* pedal in the signal chain.

“Can I hear the difference between a pedal in True Bypass or Buffered Bypass mode?”

“Maybe, maybe not – many factors apply: active vs. passive pickups, single coil vs. humbucker, cable quality, amp impedance... There is no ultimate answer. Use your ears and find the best solution for your setup!”

Kill-Dry feature

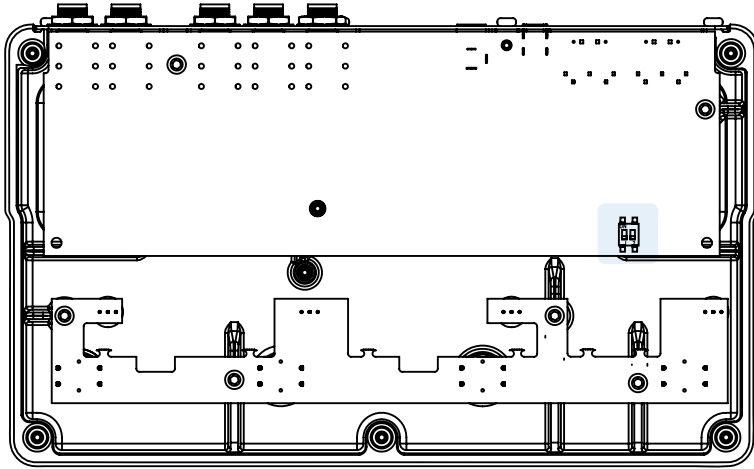

The Kill-Dry feature allows you (*you guessed it*) to “kill” the dry signal and only keep the processed signal.

If you use this pedal in the parallel effects loop of your guitar amplifier, you do *not* want the dry (unprocessed) signal to pass through the pedal, as this could lead to undesired phasing and cancellation effects.

To activate Kill-Dry, you have to open the device.

- Unscrew the back plate and look for the two small dip switches shown in the illustration.

When the pedal is set to *Buffered Bypass* mode (see page 27), you can use the right dip switch (labelled “2”) to activate Kill-Dry.

When the pedal is set to *True Bypass* mode, Kill-Dry is *not* an option.

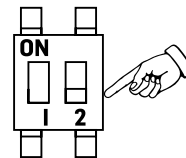

Kill-Dry off

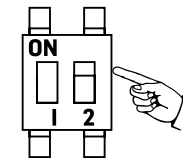

Kill-Dry on

The default mode is Kill-Dry *off* – i.e., by default, the dry signal is being passed through the pedal.