



Gravity[®] 
stand your ground.

**PREMIUM STANDS
CATALOGUE**



DESIGNED & ENGINEERED
IN GERMANY.



PREMIUM STANDS
CATALOGUE



Gravity is a brand of the Adam Hall Group.



SOUND TECHNOLOGY **LIGHT** TECHNOLOGY **STAGE** EQUIPMENT **HARDWARE** FOR FLIGHTCASES

ADAM HALL GROUP BRANDS



DISTRIBUTION BRANDS





reddot award 2016
winner

CATEGORY
MICROPHONE
STANDS



german
brand
award
17
nominee



GERMAN
DESIGN
AWARD
WINNER
2017

DESIGN MEETS QUALITY

THE NEW PREMIUM STANDS BY GRAVITY

Gravity is an award-winning line of stands and accessories for stage and studio use and a brand of the Adam Hall Group. Expert engineers and users have teamed up to create thoroughly professional products with innovative details such as our unique colour coding rings.

Continuous research and development result in an ever-growing selection of high-quality stands and accessories that are built for reliable functionality and longevity. Gravity products are made of superior materials only including thick-walled precision tubing, die-cast zinc and double injection molded thermoplastics.

With their durable heavy-duty construction, quick and easy handling and contemporary looks Gravity stands and accessories are the perfect choice when only pro quality products will do. Committed to superior design, workmanship and functionality, we provide a 5-year warranty on all Gravity products.

Gravity - Stand your ground.

- ✓ 5-year warranty on all Gravity products.
- ✓ Stands and accessories for stage and studio use.
- ✓ Professional functionality with innovative details.
- ✓ Designed and engineered in Germany.
- ✓ Ultra durable construction, built to last.
- ✓ High strength precision tubing and die-cast zinc components.
- ✓ Soft touch rubber-coated clamps and knobs.
- ✓ Double injection molded adjustment knobs.
- ✓ Replaceable rubber marker rings for colour coding and personalizing your stand.

gravitystands.com

G-RINGS

THE STYLE FACTOR

At Gravity, we believe that stands are more than just accessories. Ultimately, they are part of the show. That's why we build them for heavy duty use and easy, ergonomic handling. But we also opted for a stylish look that sets them apart from dime-a-dozen stands and makes a strong visual statement.

Gravity products feature our unique sheen green "G" rings that are replaceable in seconds. Available in a variety of attractive colours, you can now customize your stands with additional ring packs and match them to your show's visuals, music genre or personal preference.

What's more, the smart "G" ring concept provides convenient colour coding to indicate a stand's intended purpose, placement on stage or the performer to use it. Just pick your colours to add style and distinction to your stands, or choose vanta black "G" rings for a classic, discreet look. Black rings are included with all Gravity products.

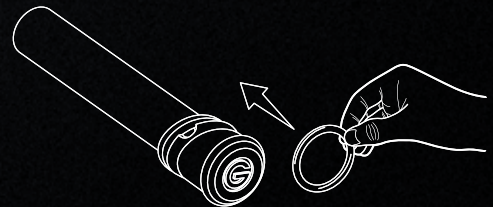

AVAILABLE COLOURS:



Sheen
Green

Sunshine
Yellow

Electric
Orange

Deep Sky
Blue

Deep Sea
blue

Power
purple

Misty Rose
Pink

Lust
Red

Concrete
Grey

Vanta
Black

Ghost
White

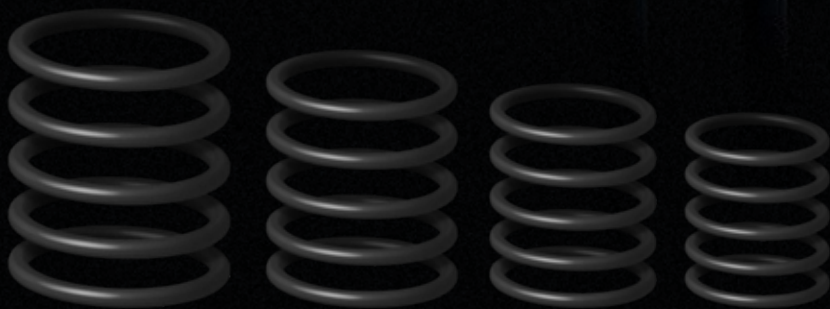

Universal Ring Pack

suitable for all Gravity® products.

Contents: 5 x 15 mm, 5 x 20 mm,
5 x 25 mm, 5 x 30 mm

Vanta Black:	GRP5555BLK1
Ghost White:	GRP5555WHT1
Concrete Grey:	GRP5555GRY1
Lust Red:	GRP5555RED1
Sunshine Yellow:	GRP5555YEL1
Sheen Green:	GRP5555CRN1
Deep Sky Blue:	GRP5555BLU1
Deep Sea Blue:	GRP5555BLU2
Electric Orange:	GRP5555ORG1
Misty Rose Pink:	GRP5555PNK1
Power Purple:	GRP5555PPL1



GRAVITY ORIGINAL REPLACEMENT PARTS

Built for durability and longevity, Gravity products are constructed from premium quality materials, such as heavy duty aluminium and steel, tough die-cast zinc and hardwearing thermoplastics.

In the unlikely event that the strains of stage and studio use take their toll, we offer a comprehensive selection of original replacement parts.

Gravity replacement parts are field serviceable enabling easy repair to extend the life of your Gravity product and provide an eco-friendly alternative to the planned obsolescence of throwaway designs.



CONTENTS

Microphone Stands	P. 10
Speaker Stands	P. 24
Lighting Stands	P. 46
Keyboard Stands	P. 54
Music Stands	P. 60
Guitar Stands	P. 68
Multimedia Equipment	P. 78
Bags	P. 82



MICROPHONE STANDS

Gravity microphone stands are easy to handle and built to last. Featuring strong, thick-walled tubing with a tough powder coating finish, they are available in folding tripod and round cast iron base versions with ergonomic clutch handles and set screw knobs for quick, convenient setup. Gravity microphone stands include straight 2-point boom adjustment models providing maximum user comfort.



MICROPHONE STANDS

FEATURES



Telescopic boom with quick release clamp for easy adjustment



Comfortable ergonomic knobs with thermoplastic rubber coating



Super accurate and stable 2-point boom joint



Soft touch rubber clutch handle for nonslip height adjustment



Specially tooled ergonomic retainer nut



High quality rubber feet



Ultra-sturdy tripod leg collar





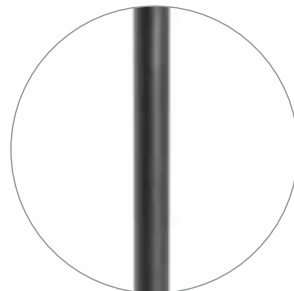





Circular base plate with rubber bottom for acoustic isolation and surface protection



Heavy-duty tubing

MICROPHONE STAND ORDER GUIDE

Gravity Microphone Stand product numbers use a simple code.
Please, use the guide below for correct model identification.

	BASE TYPE	HEIGHT	BOOM ADJUSTMENT	BOOM TYPE	EXAMPLE
	 <p>CODE 2</p>	 <p>CODE 2</p>		 <p>CODE 1</p>	
	 <p>CODE 4</p>	 <p>CODE 3</p>	 <p>CODE 2</p>	 <p>CODE 2</p>	
G M S	4	3	2	2	GMS4322
Gravity Microphone Stand					RESULTING ARTICLE NUMBER

MICROPHONE STANDS

MS 431 HB

Microphone Stand with Folding Tripod and One-Hand Clutch

The MS 431 HB is a premium quality microphone stand with thick walled tubing, powder coated finish and 179 cm maximum height. The heavy duty tripod base is made of die-cast zinc for an accurate fit of the ultra strong folding legs of steel with hefty rubber caps for surface protection. The MS 431 HB sports a slim, innovative clutch for convenient one-handed height adjustment. The ergonomic design and soft touch surface of the clutch handle provide a secure grip in all situations. The custom designed retainer requires no tools for quick and secure microphone clip attachment. A set of black coding rings is included with the MS 431 HB, additional ring packs are available in a wide array of colours for instant personalization.

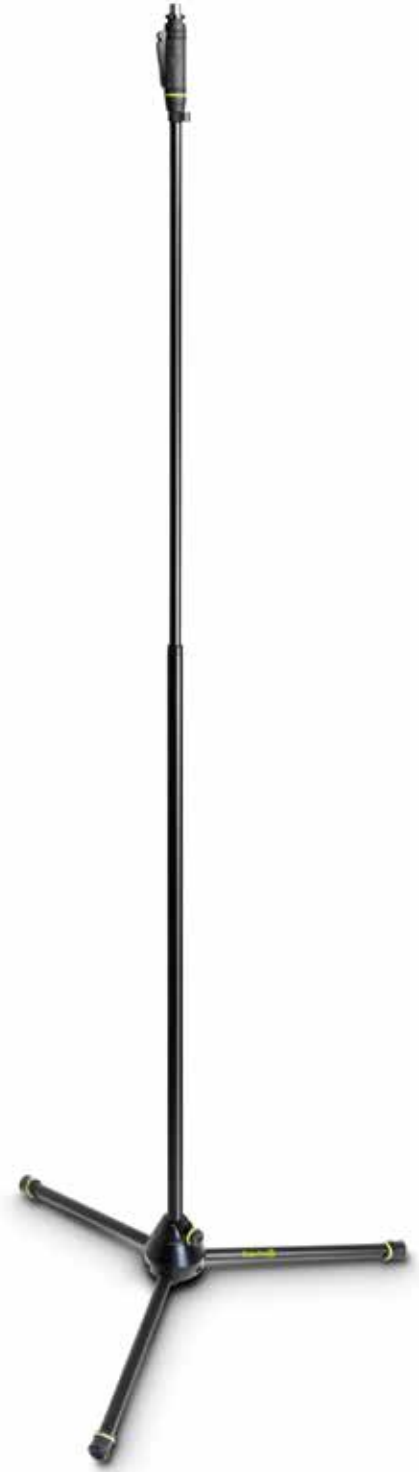

Product number	GMS431HB
Product type	Stands and tripods
Type	Microphone stands
Tubing material	Steel
Tubing colour	Black
Tubing surface	Powder coated
Min. height	1090 mm
Max. height	1790 mm
Transport length	1090 mm
Height adjustment	Yes
Base type	Tripod
Base material	Zinc die-cast
Interchangeable rings	1 x 15 mm, 4 x 20 mm
Black ring pack included	Yes
Weight	2.6 kg



MS 43

Microphone Stand with Folding Tripod Base

Product number	GMS43
Product type	Stands and tripods
Type	Microphone stands
Tubing material	Steel
Tubing colour	Black
Tubing surface	Powder coated
Min. height	1030 mm
Max. height	1690 mm
Transport length	900 mm
Height adjustment	Yes
Base type	Tripod
Base material	Zinc die-cast
Interchangeable rings	1 x 15 mm, 4 x 20 mm
Black ring pack incl.	Yes
Weight	2.3 kg



MS 4321 B

Microphone Stand with Folding Tripod Base and 2-Point Adjustment Boom

Product number	GMS4321B
Product type	Stands and tripods
Type	Microphone stands
Tubing material	Steel
Tubing colour	Black
Tubing surface	Powder coated
Min. height	1030 mm
Max. height	1690 mm
Transport length	1050 mm
Height adjustment	Yes
Base type	Tripod
Base material	Zinc die-cast
Boom model	2-point adjustment
Boom length	790 mm
Interchangeable rings	1 x 25 mm, 2 x 15 mm, 4 x 20 mm
Black ring pack incl.	Yes
Weight	2.7 kg



MS 4322 HDB

Microphone Stand Heavy Duty Microphone Stand, Tripod, 2-point Telescopic Boom

Product number	GMS4322HDB
Product type	Stands and tripods
Type	Microphone stands
Tubing material	Steel
Tubing colour	Black
Tubing surface	Powder coated
Min. height	1030 mm
Max. height	1690 mm
Transport length	1050 mm
Height adjustment	Yes
Base type	Tripod
Base material	Zinc die-cast
Boom model	2-point adjustment
Boom length	880 mm
Interchangeable rings	1 x 25 mm, 4 x 20 mm, 2 x 15 mm
Black ring pack incl.	Yes
Weight	4.26 kg

MICROPHONE STANDS



MS 4322 B / MS 4322 W

Microphone Stand with Folding Tripod Base and 2-Point Adjustment Telescoping Boom

Product number	GMS4322B / W
Product type	Stands and tripods
Type	Microphone stands
Tubing material	Steel
Tubing colour	Black / white
Tubing surface	Powder coated
Min. height	1030 mm
Max. height	1690 mm
Transport length	1050 mm
Height adjustment	Yes
Base type	Tripod
Base material	Zinc die-cast
Boom model	2-point adjustment
Boom length	880 mm
Interchangeable rings	2 x 15 mm, 4 x 20 mm, 1 x 25 mm
Black ring pack included	Yes
Weight	2.7 kg

MS 4221 B

Short Microphone Stand with Folding Tripod Base and 2-Point Adjustment Boom

Product number	GMS4221B
Product type	Stands and tripods
Type	Microphone stands
Tubing material	Steel
Tubing colour	Black
Tubing surface	Powder coated
Min. height	510 mm
Max. height	740 mm
Transport length	600 mm
Height adjustment	Yes
Base type	Tripod
Base material	Zinc die-cast
Boom model	2-point adjustment
Boom length	500 mm
Interchangeable rings	2 x 15 mm, 1 x 25 mm, 4 x 20 mm
Black ring pack included	Yes
Weight	2.2 kg



MS 4222 B

Short Microphone Stand with Folding Tripod Base and 2-Point Adjustment Telescoping Boom

Product number	GMS4222B
Product type	Stands and tripods
Type	Microphone stands
Tubing material	Steel
Tubing colour	Black
Tubing surface	Powder coated
Min. height	510 mm
Max. height	740 mm
Transport length	650 mm
Height adjustment	Yes
Base type	Tripod
Base material	Zinc die-cast
Boom model	2-point adjustment
Boom length	880 mm
Interchangeable rings	2 x 15 mm, 4 x 20 mm, 1 x 25 mm
Black ring pack included	Yes
Weight	2.2 kg



Heavy Base for Bass Drum Micing!

MS 3122 HDB

Short Heavy Duty Microphone Stand with Folding Tripod Base

Product number	GMS3122HDB
Product type	Stands and tripods
Type	Microphone stands
Tubing material	Steel
Tubing colour	Black
Tubing surface	Powder coated
Max. height	320 mm
Transport length	500 mm
Height adjustment	No
Base type	Tripod
Base material	Zinc die-cast
Boom model	2-point adjustment
Boom length	880 mm
Interchangeable rings	1 x 25 mm , 2 x 15 mm , 3 x 20 mm
Black ring pack included	Yes
Weight	2.84 kg

MICROPHONE STANDS

MS 23 XLR B

Microphone Stand with XLR Connector and Gooseneck

Enabling ultra flexible microphone orientation, this premium quality stand features a 36.5 cm gooseneck on a thick walled 114.5 cm tube and a heavy duty round base made of cast iron. The gooseneck integrates a 3-pin female XLR connector for directly attaching a microphone while the tube sports a lateral XLR mic cable connector at the bottom end. This permits quick, clean setup without mic clips and running the cable up the stand. To extend the stand's height and increase stability, additional XLR goosenecks (item no. GMAGOOSEMXLR) and a weight disc (item no. GMS2WP) are available as accessories.



Product number	GMS231HB
Product type	Stands and tripods
Type	Microphone stands
Tubing material	Steel
Tubing colour	Black
Tubing surface	Powder coated
Min. height	1080 mm
Max. height	1750 mm
Transport length	1080 mm
Height adjustment	Yes
Base type	Round base
Base material	Cast iron
Base diameter	270 mm
Base weight	3.6 kg
Interchangeable rings	1 x 20 mm
Black ring pack included	Yes
Weight	4.4 kg



MS 231 HB

Microphone Stand with Round Base and One-Hand Clutch

The MS 231 HB is a premium quality microphone stand with thick walled tubing, powder coated finish and 175 cm maximum height. Made of cast iron, the heavy duty round base features a rubber ring at the bottom for acoustic isolation and surface protection. The MS 231 HB sports a slim, innovative clutch for convenient one-handed height adjustment. The ergonomic design and soft touch surface of the clutch handle provide a secure grip in all situations. The custom designed retainer requires no tools for quick and secure microphone clip attachment. A set of black coding rings is included with the MS 231 HB, additional ring packs are available in a wide array of colours for instant personalization. For increased stability we offer a 2.3 kg add-on weight plate that installs without tools (part no. GMS2WP).



Product number	GMS231HB
Product type	Stands and tripods
Type	Microphone stands
Tubing material	Steel
Tubing colour	Black
Tubing surface	Powder coated
Min. height	1080 mm
Max. height	1750 mm
Transport length	1080 mm
Height adjustment	Yes
Base type	Round base
Base material	Cast iron
Base diameter	270 mm
Base weight	3.6 kg
Interchangeable rings	1 x 20 mm
Black ring pack included	Yes
Weight	4.4 kg



MICROPHONE STANDS



MS 23 / MS 23 W
Straight Microphone Stand
with Round Base

Product number	GMS23 / W
Product type	Stands and tripods
Type	Microphone stands
Tubing material	Steel
Tubing colour	Black / white
Tubing surface	Powder coated
Min. height	1000 mm
Max. height	1600 mm
Transport length	1000 mm
Height adjustment	Yes
Base type	Round base
Base material	Cast iron
Base diameter	270 mm
Base weight	3.6 kg
Interchangeable rings	1 x 20 mm
Black ring pack incl.	Yes
Weight	4.2 kg



MS 2321 B
Microphone Stand with
Round Base and 2-Point
Adjustment Boom

Product number	GMS2321B
Product type	Stands and tripods
Type	Microphone stands
Tubing material	Steel
Tubing colour	Black
Tubing surface	Powder coated
Min. height	1000 mm
Max. height	1680 mm
Transport length	1000 mm
Height adjustment	Yes
Base type	Round base
Base material	Cast iron
Base diameter	270 mm
Base weight	3.6 kg
Boom model	2-point adjustment
Boom length	790 mm
Interchangeable rings	1 x 20 mm, 1 x 15 mm, 1 x 25 mm
Black ring pack incl.	Yes
Weight	4.8 kg



MS 2322 B
Microphone Stand
with Round Base and
2-Point Adjustment
Telescoping Boom

Product number	GMS2322B
Product type	Stands and tripods
Type	Microphone stands
Tubing material	Steel
Tubing colour	Black
Tubing surface	Powder coated
Min. height	1000 mm
Max. height	1680 mm
Transport length	1050 mm
Height adjustment	Yes
Base type	Round base
Base material	Cast iron
Base diameter	270 mm
Base weight	3.6 kg
Boom model	2-point adjustment
Boom length	880 mm
Interchangeable rings	1 x 15 mm, 1 x 20 mm, 1 x 25 mm
Black ring pack incl.	Yes
Weight	4.8 kg



MS 2221 B

Short Microphone Stand with Round Base and 2-Point Adjustment Boom

Product number	GMS2221B
Product type	Stands and tripods
Type	Microphone stands
Tubing material	Steel
Tubing colour	Black
Tubing surface	Powder coated
Min. height	480 mm
Max. height	730 mm
Transport length	500 mm
Height adjustment	Yes
Base type	Round base
Base material	Cast iron
Base diameter	270 mm
Base weight	3.6 kg
Boom model	2-point adjustment
Boom length	500 mm
Interchangeable rings	1 x 20 mm, 1 x 25 mm
Black ring pack incl.	Yes
Weight	4 kg

MS 2222 B

Short Microphone Stand, with Round Base and 2-Point Adjustment Telescoping Boom

Product number	GMS2222B
Product type	Stands and tripods
Type	Microphone stands
Tubing material	Steel
Tubing colour	Black
Tubing surface	Powder coated
Min. height	480 mm
Max. height	730 mm
Transport length	550 mm
Height adjustment	Yes
Base type	Round base
Base material	Cast iron
Base diameter	270 mm
Base weight	3.6 kg
Boom model	2-point adjustment
Boom length	880 mm
Interchangeable rings	1 x 15 mm, 1 x 20 mm, 1 x 25 mm
Black ring pack incl.	Yes
Weight	4 kg



MST 01 B

Table-Top Microphone Stand

Product number	GMST01B
Product type	Stands and tripods
Type	Microphone stands
Tubing material	Steel
Tubing colour	Black
Tubing surface	Powder coated
Max. height	200 mm
Base material	Cast iron
Base diameter	130 mm
Boom	No
Weight	1.26 kg

MICROPHONE STANDS

SSMS SET 1

Set of 2 Speaker and 2 Microphone Stands in Transport Bag

This set includes two Gravity GSP5211B tripod speaker stands and two GMS4322B microphone stands with folding tripod base and 2-Point adjustment telescoping boom in the padded heavy duty GBGSS2MS2B carry bag for convenient, easy transport.



Product number	GSSMSSET1	Gravity speaker stands	GSP5211B	Gravity microphone stands	GMS4322B
Gravity transport bag	GBGSS2MS2B	Product type	Stands and tripods	Product type	Stands and tripods
Product type	Stands and tripods	Type	Speaker stands	Type	Microphone stands
Type	Speaker stands, speaker and microphone stands	Tubing material	Aluminium	Tubing material	Steel
Number of stands	4	Tubing colour	Black	Tubing colour	Black
Bag colour	Black	Tubing surface	Powder coated	Tubing surface	Powder coated
Bag surface	Nylon 600D	Min / Max height	1060 mm / 1920 mm	Min / Max height	1030 mm / 1690 mm
Thickness of bag padding	10 mm	Transport length	1050 mm	Transport length	1050 mm
Latch	Zip	Height adjustment	Clamp with safety pin	Height adjustment	Yes
Width	1050 mm	Material of height adjustment	Steel	Base type / material	Tripod / zinc die-cast
Height	450 mm	Base type / material	Leg joint / die-cast aluminium	Boom model	2-point adjustment
Depth	180 mm	Tubing diameter	35 mm	Boom length	880 mm
Weight	Cast iron	Max. load	50 kg	Interchangeable rings	2 x 15 mm, 4 x 20 mm, 1 x 25 mm
Base diameter	13.4 kg	Interchangeable rings	5 x 30 mm	Black ring pack included	Yes
		Black ring pack included	Yes	Weight	2.7 kg
		Weight	2.2 kg		

MS CAB CL 01

Cab Clamp Microphone Holder for Guitar Cabinets

This universal clamping system allows you to mic up a guitar cabinet in an easy and revolutionary way. The spring-loaded clamping arm makes the clamp suitable for almost any type of cabinet and securely fastens to the side or top of a cabinet or combo amplifier. Thanks to its adjustable edge grip, the clamp can be adjusted to fit snugly onto recessed edges. The rigid boom is finely adjustable in both boom angle and microphone depth – this ensures a far more precise and secure mic placement as opposed to using a gooseneck-based clamping system or conventional mic stand.



Product number	GMSCABCL01
Product type	Microphone accessories
Type	Microphone holder
Material	Aluminium
Surface	Powder coated
Colour	Black
Clamping width	250 - 400
Extension length	250 mm
Threaded connector	3/8 "
Weight	0.6 kg



ACCESSORIES MICROPHONE STANDS



NS MS 01

Music stand desk for Microphone Stands

This simple but smart adaptation of a music stand desk allows you to convert any microphone stand into a music stand. This music desk is equipped with a 3/8" female thread and can be attached to any product with a male counterpart thread. The desk can thus also be attached to various kinds of mic holders such as table-top or conventional stands – opening a whole new world of options.



Product number	GNSMS01
Product type	Stands and tripods
Type	Music stand
Music desk type	Perforated music desk
Support material	Steel
Support surface	Powder coated
Support colour	Black
Support width	340 mm
Support height	475 mm
Weight	1.8 kg

MSTM 1 B

Table Clamp For Microphones

The Gravity MSTM 1 B microphone table clamp firmly attaches to desk or podium tops with a maximum thickness of 45 mm. It is made of 4 mm steel with a plastic tipped set screw and 3/8" threaded bolt for mic clip, mic clamp or gooseneck mounting.



Product number	GMSTM1B
Product type	Microphone accessories
Type	Microphone holder
Colour	Black
Material	Steel
Surface	Powder coated
Threaded connector	3/8"
For table top thickness	Up to 45 mm
Interchangeable rings	1 x 20 mm
Weight	0.185 kg

ACCESSORIES MICROPHONE STANDS



MS B 21

2-Point Adjustment Boom Arm

This 80 cm boom arm features a cast aluminium hub with precision 2-point tilt and position adjustment and 3/8" male thread. The ergonomic set screw knobs are made from high-grade ABS with a soft touch, non-slip thermoplastic coating for comfortable operation.



Product number	GMSB21
Tubing material	Steel
Tubing colour	Black
Tubing surface	Powder coated
Boom length	800 mm
Interchangeable rings	1 x 15 mm, 1 x 25 mm
Black ring pack included	Yes
Weight	0.4 kg

MS B 22 / MS W 22

2-Point Adjustment Telescoping Boom Arm

This telescoping boom arm features a cast aluminium hub with precision 2-point tilt and position adjustment and 3/8" male thread. The ergonomic set screw knobs are made from high-grade ABS with a soft touch, non-slip thermoplastic coating for comfortable operation. A convenient quick fastener allows for variable extension to a maximum length of 88 cm facilitating flexible mic placement.



Product number	GMSB22 / GMSW22
Tube material	Steel
Tubing colour	Black / white
Tubing surface	Powder coated
Boom length	500 - 880 mm
Telescoping	Yes
Boom model	2-point adjustment
Interchangeable rings	1 x 15 mm, 1 x 25 mm
Black ring pack included	Yes
Weight	0.43 kg



ACCESSORIES MICROPHONE STANDS

Patented
Vari-Weight® stability system

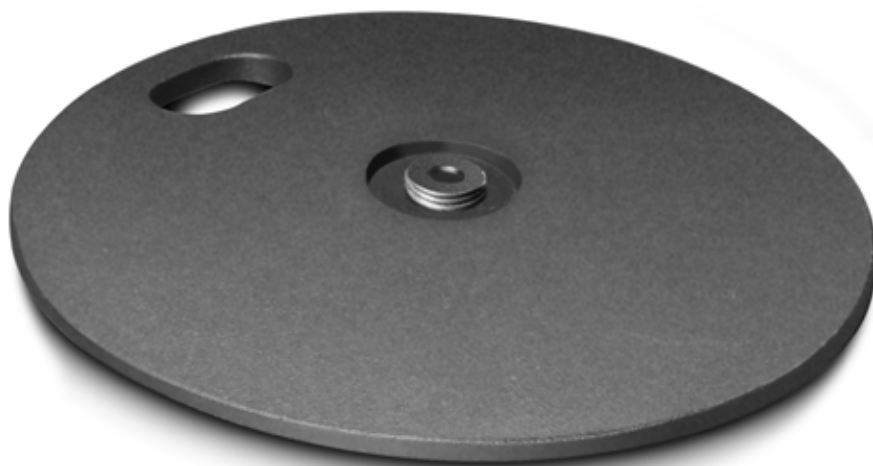

MS 2 WP

Weight Plate for Round Base Microphone Stands

At 2.3 kg, this cast iron weight plate can be attached to all round base Gravity microphone stands without the need for tools, providing increased stability. Vari-Weight® - patented stability system for secure holding and simple transportation by means of an insertable weight plate. Round base not included in delivery.

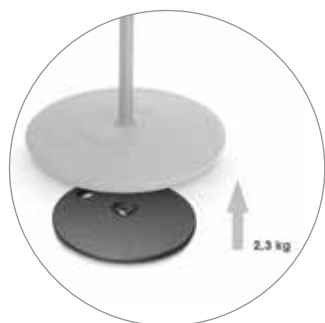

Product number	GMS2WP
Product type	Stands and tripod accessories
Material	Cast iron
Colour	Black
Surface	Powder coated
Diameter	210 mm
Weight	2.3 kg

MA DRINK M

Medium Microphone Stand Drink Holder

This drink holder features a unique screw clamp that is adjustable for vertical or horizontal mounting options. It fits on mic stands, speaker stands and music stands with tubing diameters up to 35 mm as well as table tops and securely holds bottles, cans, cups and glasses with a maximum diameter of 70 mm.



Product number	GMSDRINKM
Product type	Microphone Accessories
Material	Plastic, steel
Colour	Black
Suitable for tube diameter	up to 35 mm
Inner diameter	70 mm
Width	87 mm
Height	102 mm
Interchangable rings	1 x 15 mm
Black ring pack included	Yes
Weight	0.16 kg

ACCESSORIES MICROPHONE STANDS

MA DRINK L

Large Microphone Stand Drink Holder

This drink holder features a unique screw clamp that is adjustable for vertical or horizontal mounting options. It fits on mic stands, speaker stands and music stands with tubing diameters up to 35 mm as well as table tops and securely holds bottles, cans, cups and glasses with a maximum diameter of 90 mm.



Product number	GMSDRINKL
Product type	Microphone Accessories
Material	Plastic, steel
Colour	Black
Suitable for tube diameter	up to 35 mm
Inner diameter	90 mm
Width	110 mm
Height	135 mm
Interchangable rings	1 x 15 mm
Black ring pack included	Yes
Weight	0.18 kg



MA GOOSE M XLR

XLR Gooseneck, Medium, 365 mm

This flexible yet rigid 15 mm diameter gooseneck has a male 3-pin XLR at one end and a female 3-pin XLR at the other. Made of steel with a black powder coating finish, it holds weight easily while maintaining its bending radius.



Product number	GMAGOSEMCLR
Product type	Goosenecks
Material	Steel
Colour	Black
Connector 1	XLR 3-pin male
Connector 2	XLR 3-pin female
Length	365 mm
Diameter	15 mm
Weight	0.3 kg

ACCESSORIES MICROPHONE STANDS



MA GOOSE XL

Gooseneck
Extra Long 600 mm

Product number	GMAGOOSEXL
Product type	Goosenecks
Material	Steel
Colour	Black
Connector 1	3/8" thread
Connector 2	3/8" thread
Length	600 mm
Diameter	15 mm
Weight	0.47 kg

MA GOOSE L

Gooseneck
Long 460 mm

Product number	GMAGOOSEL
Product type	Goosenecks
Material	Steel
Colour	Black
Connector 1	3/8" thread
Connector 2	3/8" thread
Length	460 mm
Diameter	15 mm
Weight	0.41 kg

MA GOOSE M

Gooseneck
Medium 320 mm

Product number	GMAGOOSEM
Product type	Goosenecks
Material	Steel
Colour	Black
Connector 1	3/8" thread
Connector 2	3/8" thread
Length	320 mm
Diameter	15 mm
Weight	0.26 kg

MA GOOSE S

Gooseneck
Short 140 mm

Product number	GMAGOOSE S
Product type	Goosenecks
Material	Steel
Colour	Black
Connector 1	3/8" thread
Connector 2	3/8" thread
Length	140 mm
Diameter	15 mm
Weight	0.12 kg



MS CLMP 25

Microphone Clamp, 25mm

Product number	GMSCLMP25
Product type	Microphone Accessories
Material	Plastic
Microphone mount (diameter)	24 - 35 mm
Base thread	5/8"
Features	3/8" Adapter
Weight	0.05 kg



MS CLMP 34

Microphone Clamp, 34mm

Product number	GMSCLMP34
Product type	Microphone Accessories
Material	Plastic
Microphone mount (diameter)	34 - 42 mm
Threaded connector	5/8"
Features	3/8" Adapter
Weight	0.062 kg



ACCESSORIES MICROPHONE STANDS



MS QC 1 B

Quick Coupler for Microphone Clips & Boom Arms

Product number	GMSQC1B
Product type	Stands and tripod accessories
Type	Microphone stands
Material	Aluminium
Colour	Black
Surface	Powder coated
Height	90 mm
Thread stand	5/8"
Thread microphone	3/8"
Weight	0.13 kg



MSQC 1 TB
Quick Coupler
Crown
individually
available



MS QT 1 B

Microphone Adapter Quick-Tilt Ball-Joint

Product number	GMSQT1B
Product type	Stands and tripod accessories
Colour	Black
Material	Aluminium
Surface	Powder coated
Threaded connector	3/8"
Length	55 mm
Interchangeable rings	1 x 20 mm
Black ring pack included	Yes
Weight	0.086 kg





MA TRAY 1

Microphone Stand Tray 250 mm x 195 mm

Product number	GMATRAY1
Product type	Stands and tripod accessories
Material	Steel
Colour	Black
Suitable for mounting on	Microphone stand
Support width	250 mm
Support depth	195 mm
Extension Length	200 mm
Black ring pack included	Yes
Weight	1.1 kg



MA TRAY 2

Microphone Stand Tray 400 mm x 130 mm

Product number	GMATRAY2
Product type	Stands and tripod accessories
Material	Steel
Colour	Black
Suitable for mounting on	Microphone stand
Support width	400 mm
Support depth	130 mm
Extension Length	50 mm
Black ring pack included	Yes
Weight	0.4 kg



ACCESSORIES MICROPHONE STANDS



HP HMS 01 B

Headphones Holder For Microphone Stand

Product number	GHPHMS01B
Product type	Headphone holder
Material	Plastic / steel
Mounting	Microphone stand
Colour	Black
Support width	60 mm
Deck depth	100 mm
Interchangeable rings	1 x 20 mm
Black ring set included	Yes
Weight	0.175 kg



MS AMP DS 01

Dock for Mounting on Guitar Amplifiers & Cabinets

Product number	GMSAMPDS01
Product type	Microphone accessories
Type	Microphone clip
Material	Zinc die-cast
Surface	Powder coated
Colour	Black
Threaded connector	3/8" x 5/8"
Width	42 mm
Depth	48 mm
Height	30 mm
Weight	0.12 kg
Additional information	Screw set, rubber for decoupling included





XSP 1062

Counter nut 3/8"

Product number	GMSQT1B
Product type	Lock nut
Material	Aluminium
Colour	Black
Surface	Painted
Diameter	25 mm
Length	55 mm
Height	5 mm
Weight	0.007 kg



MA MH 01

Microphone Holder

Product number	GMAMH01
Product type	Microphone holder
Colour	Black
Material	Steel
Surface	Powder coated
Suitable for tube diameter	up to 30 mm
Threaded connector	3/8"
Length	160 mm
Interchangeable rings	2 x 20 mm
Black ring pack included	Yes
Weight	0.14 kg





SPEAKER STANDS

Gravity speaker stands use thick walled precision tubing, steel height adjustment collars and redesigned leg housings for maximum strength and durability. Air cushion and hand crank versions greatly facilitate lifting and lowering heavy loads, and our low-profile round base model provides an elegant, small footprint alternative to conventional tripods. In addition, the Gravity range includes stands for your studio monitors, subwoofer poles and a selection of stand adapters.



SPEAKER STANDS

FEATURES



Sturdy, virtually indestructible steel collar with safety pin



Comfortable ergonomic knobs



Specially designed aluminium die-cast leg collar for superior strength



Crank operation for easy speaker raising and lowering

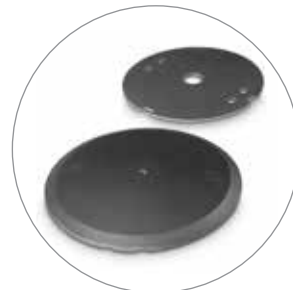

Vari-Weight® - Low-profile 9 kg cast iron base and a 5 kg weight plate which installs without tools



Tight, secure fit

SP 5211

Speaker Stand 35 mm

The SP 5211 is a classic tripod speaker stand made from thick walled, yet lightweight powder coated aluminium tubing with a load capacity of 50 kg and 192 cm maximum height. The die-cast aluminium leg collar has been completely redesigned to provide superior durability and longevity, the height adjustment collar is made of steel for additional strength and is virtually indestructible. It features a safety pin to securely lock the 35 mm diameter extension pole in place. The ergonomic set screw knobs are made from high grade ABS with a soft touch, non-slip thermoplastic coating for comfortable operation. A set of black coding rings is included with the SP 5211, additional ring packs are available in a wide array of colours for instant personalization.

Product number	GSP5211B / W	GSP5212B
Product type	Stands and tripods	Stands and tripods
Type	Speaker stands	Speaker stands
Tubing material	Aluminium	Steel
Tubing colour	Black / white	Black
Tubing surface	Powder coated	Powder coated
Min height:	1060 mm	1060 mm
Max height	1920 mm	1920 mm
Transport length	1050 mm	1050 mm
Height adjustment	Clamp with safety pin	Clamp with safety pin
Material of height adjustment	Steel	Steel
Base type	Leg joint	Leg joint
Base material	Die-cast aluminium	Die-cast aluminium
Tubing diameter	35 mm	35 mm
Max. load	50 kg	50 kg
Interchangeable rings	5 x 30 mm	5 x 30 mm
Black ring pack included	Yes	Yes
Weight	2.2 kg	4.7 kg

Also available
with steel tubing
(SP 5212 B).



SPEAKER STANDS

SP 5211 ACB

Speaker Stand Pneumatic, 35 mm Steel

The SP 5211 ACB is a classic tripod speaker stand made from thick walled, yet lightweight powder coated aluminium tubing with a load capacity of 50 kg and 192 cm maximum height. The die-cast aluminium leg collar has been completely redesigned to provide superior durability and longevity, the height adjustment collar is made of steel for additional strength and is virtually indestructible. It features a safety pin to securely lock the 35 mm diameter extension pole in place. The ergonomic set screw knobs are made from high grade ABS with a soft touch, non-slip thermoplastic coating for comfortable operation. The built in air cushion acts as a pneumatic shock absorber and allows you to gently lower even heavy loads. A set of black coding rings is included with the SP 5211 ACB, additional ring packs are available in a wide array of colours for instant personalization.

Product number	GSP5211ACB
Product type	Stands and tripods
Type	Speaker stands
Tubing material	Aluminium
Tubing colour	Black
Tubing surface	Powder coated
Min height:	1060 mm
Max height	1920 mm
Transport length	1050 mm
Height adjustment	Yes
Material of height adjustment	Steel
Base type	Tripod
Base material	Die-cast aluminium
Tubing diameter	35 mm
Max. load	50 kg
Black ring pack included	Yes
Weight	2.8 kg





SS 5212 BSET 1
Set of 2 Speaker Stands
in Steel with Bag

SS 5211 BSET 1
Set of 2 Speaker Stands
in Aluminium with Bag

Product number	GSS5212BSET1	GSS5211BSET1
Gravity transport bag	GBGSS2B	GBGSS2B
Product type	Speaker stands	Speaker stands
Number of stands	2	2
Type of stand	Speaker tripod	Speaker tripod
Material	Nylon 600D	Nylon 600D
Thickness of the padding	15 mm	15 mm
Latch	Double zip	Double zip
Dimensions (W x H x D)	1070 x 190 x 290 mm	1070 x 190 x 290 mm
Transport length	1050 mm	1050 mm
Gravity speaker stands	GSP5212B	GSP5211B
Product type	Speaker stands	Speaker stands
Tubing material	Steel	Aluminium
Tubing surface / colour	Powder coated / black	Powder coated / black
Min. / max. height	1060 mm / 1920 mm	1060 mm / 1920 mm
Transport length	1050 mm	1050 mm
Height adjustment	Clamp with safety pin	Clamp with safety pin
Material of height adjustment	Steel	Steel
Base type / material	Leg joint / die-cast aluminium	Leg joint / die-cast aluminium
Tubing diameter	35 mm	35 mm
Max. load	50 kg	50 kg
Interchangeable rings	5 x 30 mm	5 x 30 mm
Black ring pack incl.	Yes	Yes
Weight	4.7 kg	2.2 kg

SPEAKER STANDS

SSMS SET 1

Set of 2 Speaker and 2 Microphone Stands in Transport Bag

This set includes two Gravity GSP5211B tripod speaker stands and two GMS4322B microphone stands with folding tripod base and 2-Point adjustment telescoping boom in the padded heavy duty GBGSS2MS2B carry bag for convenient, easy transport.



Product number	GSSMSSET1	Gravity speaker stands	GSP5211B	Gravity microphone stands	GMS4322B
Gravity transport bag	GBGSS2MS2B	Product type	Stands and tripods	Product type	Stands and tripods
Product type	Stands and tripods	Type	Speaker stands	Type	Microphone stands
Type	Speaker stands, speaker and microphone stands	Tubing material	Aluminium	Tubing material	Steel
Number of stands	4	Tubing colour	Black	Tubing colour	Black
Bag colour	Black	Tubing surface	Powder coated	Tubing surface	Powder coated
Bag surface	Nylon 600D	Min / Max height	1060 mm / 1920 mm	Min / Max height	1030 mm / 1690 mm
Thickness of bag padding	10 mm	Transport length	1050 mm	Transport length	1050 mm
Latch	Zip	Height adjustment	Clamp with safety pin	Height adjustment	Yes
Width	1050 mm	Material of height adjustment	Steel	Base type / material	Tripod / zinc die-cast
Height	450 mm	Base type / material	Leg joint / die-cast aluminium	Boom model	2-point adjustment
Depth	180 mm	Tubing diameter	35 mm	Boom length	880 mm
Weight	Cast iron	Max. load	50 kg	Interchangeable rings	2 x 15 mm, 4 x 20 mm, 1 x 25 mm
Base diameter	13.4 kg	Interchangeable rings	5 x 30 mm	Black ring pack included	Yes
		Black ring pack included	Yes	Weight	2.7 kg
		Weight	2.2 kg		

SP 4722 B

Wind Up Speaker Stand

The Gravity SP 4722 B is a heavy-duty speaker stand with a convenient hand crank and rack and pinion that make it easy to raise your speakers to the desired height. It is made of hard-wearing steel tubing with a folding tripod base and durable cast aluminium leg collar. A large knob set screw and safety pin secure the telescoping pole, which extends from 1.5 m to a maximum height of 2.4 m. The stand is TÜV/GS certified.

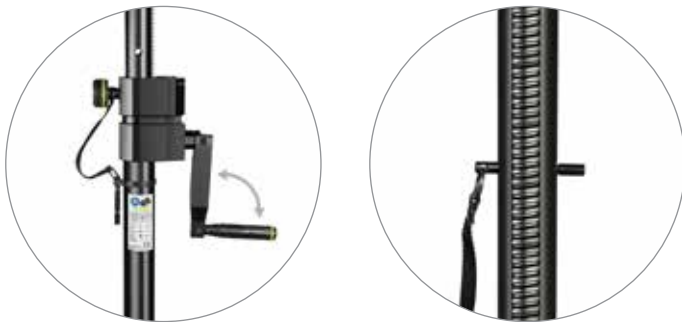

Product number	GSP4722B
Product type	Stands and tripods
Type	Speaker stands
Tubing material	Steel
Tubing colour	Black
Tubing surface	Powder coated
Min height:	1500 mm
Max height	2400 mm
Joint material	Metal
Tubing diameter	35 mm
Max. load	40 kg
Interchangeable rings	2 x 20 mm
Black ring pack included	Yes
Weight	9.31 kg



SPEAKER STANDS

SSP WB SET 1

Speaker Stand with Round Cast Iron Base

Sporting a smaller footprint than conventional tripods this heavy-duty speaker stand features a 35 mm steel pole with unbreakable steel collar, ergonomic set screw knob and safety pin for easy and secure height adjustment. It extends from 1.05 to 1.8 m in 7.5 cm increments. The heavy, low-profile 10 kg cast iron base with additional 5 kg weight plate provides a secure footing and increased stability.

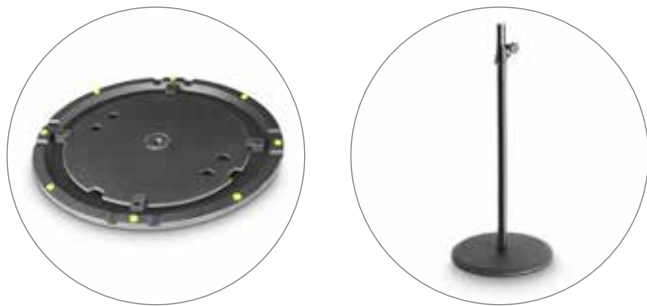

Product number	GSSPWSET1 / W
Gravity round cast iron base for M20 poles	GWB123B / W
Product type	Stands and tripod accessories
Pedestal material	Die-cast iron
Diameter	450 mm
Colour	Black / white
Threaded connector	M20 female
Additional information	5 kg extra weight plate available
Weight	10 kg
Extra weight plate for round base	GWB123WPB
Material	Cast iron
Colour	Black
Surface	Powder coated
Diameter	350 mm
Features	Weight plate can be mounted quickly and without tools
Weight	5 kg
Gravity adjustable speaker pole 35 mm	GSP2342B / W
Product type	Stands and Tripod Accessories
Tubing colour	Black / white
Tubing surface	Powder coated
Tubing diameter	35 mm
Threaded connector	M20
Min. / max. height	1050 mm / 1800 mm
Weight	2.1 kg



SP 5522 B

Twin Extension Speaker & Lighting Pole

The SP 5522 B is a classic tripod speaker and lighting stand made from thick walled, yet lightweight powder coated steel tubing with a load capacity of 30 kg and twin extensions for a maximum height of 3 m. The die-cast aluminium leg collar has been completely redesigned to provide superior durability and longevity. The unbreakable height adjustment collars are made of steel for additional strength featuring safety pins to securely lock the extensions in place. The ergonomic set screw knobs are made from high grade ABS with a soft touch, non-slip thermoplastic coating for comfortable handling. A set of black coding rings is included with the SP 5522 B, additional ring packs are available in a wide array of colours for instant personalization.

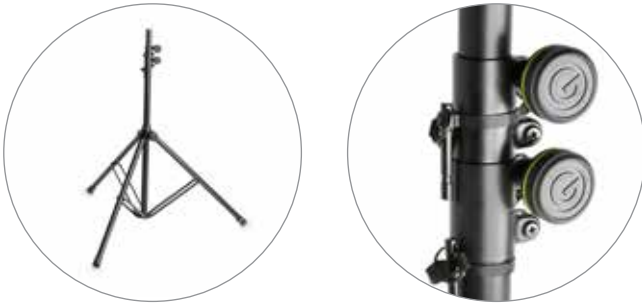

Product number	GSP5522B
Product type	Speaker stands
Tube material	Steel
Tube colour	Black
Tube surface	Powder coated
Max height	3000 mm
Min height:	1110 mm
Height-adjustable	Yes
Material of height adjustment	Steel
Number of extensions	2
Thread stand	M10
Base type	Tripod
Base material	Die-cast aluminium
Tube diameter	35 mm
Max. load	30 kg
Interchangeable rings	5 x 30 mm
Black ring pack included	Yes
Weight	6.3 kg



SPEAKER STANDS

SP 2472 B

Adjustable Speaker Pole with Crank,
35mm to M20, 1100 mm

The Gravity SP 2472 B is a heavy-duty 35 mm speaker pole with convenient rack and pinion hand crank to facilitate raising and lowering your speakers. Made of hardwearing steel with black powder coating finish, it features a 40 kg load capacity, variable length from 0.8 m to 1.1 m and a male threaded M20 bottom end.



Product number	GSP2472B
Product type	Speaker stands
Tubing material	Steel
Tubing colour	Black
Tubing surface	Powder coated
Min height:	800 mm
Max height	1100 mm
Joint material	Metal
Tubing diameter	35 mm
Max. load	40 kg
Interchangeable rings	1 x 20 mm, 1 x 30 mm
Black ring pack included	Yes
Weight	3 kg





SP 2342 B / SP 2342 W

Adjustable Speaker Pole for 35 mm to M20,
1800 mm

Product number	GSP2342B / W
Product type	Stands and tripod accessories
Colour	Black / white
Surface	Powder coated
Tube diameter	35 mm
Threaded connector	M20
Min height:	1050 mm
Max height	1800 mm
Interchangeable rings	Yes
Weight	2.1 kg



SP 2332 EXT B / SP 2332 EXT W

Speaker Pole Extension

Product type	GSP2332EXTB / W
Product type	Stands and tripod accessories
Material	Steel
Colour	Black / white
Surface	Powder coated
Length	500 mm
Threaded connector	M20 male
Threaded connector 2	M20 female
Interchangeable rings	No
Weight	0.9 kg

SPEAKER STANDS



1-Part

SP 2332 B

Adjustable Speaker Pole 35 mm to M20, 1400 mm

Product number	GSP2332B
Product type	Stands and tripods
Type	Speaker stands
Tubing material	Steel
Tubing colour	Black
Tubing surface	Powder coated
Min height:	820 mm
Max height	1400 mm
Transport length	820 mm
Height adjustment	Clamp with safety pin
Material of height adjustment	Steel
Connector 1	M20
Connector 2	35 mm
Max. load	40 kg
Interchangeable rings	1 x 30 mm
Black ring pack included	Yes
Weight	1.84 kg



1-Part

SP 3332 B

Adjustable Speaker Pole 35 mm to 35 mm, 1400 mm

Product number	GSP3332B
Product type	Stands and tripods
Type	Speaker stands
Tubing material	Steel
Tubing colour	Black
Tubing surface	Powder coated
Min height:	820 mm
Max height	1400 mm
Transport length	820 mm
Height adjustment	Clamp with safety pin
Material of height adjustment	Steel
Connector 1	35 mm
Connector 2	35 mm
Max. load	40 kg
Interchangeable rings	1 x 30 mm
Black ring pack included	Yes
Weight	1.56 kg



SP 2332 TPB

Adjustable Two Part Speaker Pole 35 mm to M20, 1400 mm

Product number	GSP2332TPB
Product type	Stands and tripods
Type	Speaker stands
Tubing material	Steel
Tubing colour	Black
Tubing surface	Powder coated
Min height:	1050 mm
Max height	1400 mm
Transport length	540 mm
Height adjustment	Clamp with safety pin
Material of height adjustment	Steel
Connector 1	M20
Connector 2	35 mm
Max. load	40 kg
Interchangeable rings	1 x 30 mm
Black ring pack included	Yes
Weight	2.2 kg



SP 3332 TPB

Adjustable Two Part Speaker Pole 35 mm to 35 mm, 1400 mm

Product number	GSP3332TPB
Product type	Stands and tripods
Type	Speaker stands
Tubing material	Steel
Tubing colour	Black
Tubing surface	Powder coated
Min height:	1050 mm
Max height	1400 mm
Transport length	540 mm
Height adjustment	Clamp with safety pin
Material of height adjustment	Steel
Connector 1	35 mm
Connector 2	35 mm
Max. load	40 kg
Interchangeable rings	1 x 30 mm
Black ring pack included	Yes
Weight	2.15 kg

SPEAKER STANDS

SP 3202 VT

Vari-Tilt® Studio Monitor Speaker Stand

The Gravity SP 3202 VT monitor speaker stand features a heavy triangular cast iron base and 25 x 25 cm steel tray with isolating foam rests and variable tilt up to 10°. It is height-adjustable from 90 to 150 cm for optimum speaker positioning and comes with a set of spikes that mount to the large integrated rubber feet for superior acoustic coupling to the floor.

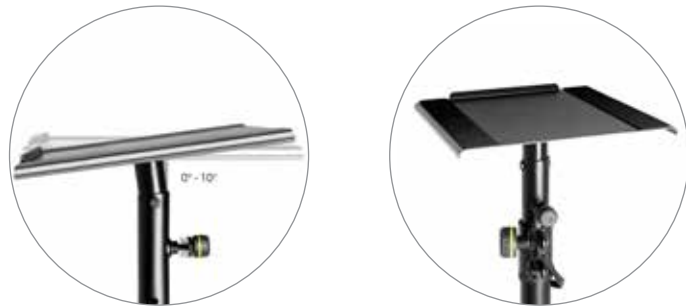

Product number	GSP3202VT
Product type	Stands and tripods
Type	Speaker stands
Tubing material	Steel
Tubing colour	Black
Tubing surface	Powder coated
Min height:	900 mm
Max height	1500 mm
Height adjustment	Clamp with safety pin
Base type	3-point
Base material	Cast iron
Base edge length	292.5 mm
Lower connector	M20
Tubing diameter	42 mm/35 mm
Max. load	50 kg
Interchangeable rings	1 x 15 mm, 1 x 20 mm, 1 x 30 mm
Black ring pack included	Yes
Weight	7 kg
Additional information	Including acoustic isolation spikes



SP 3202

Speaker Stand for Studio Monitors

The Gravity SP 3202 monitor speaker stand features a heavy triangular cast iron base and 25 x 25 cm steel tray with isolating foam rests. It is height-adjustable from 90 to 150 cm for optimum speaker positioning and comes with a set of spikes that mount to the large integrated rubber feet for superior acoustic coupling to the floor.

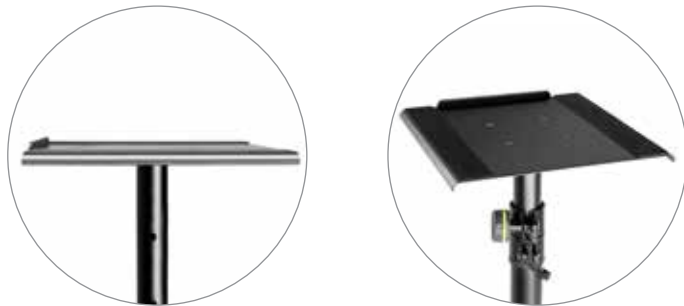

Product number	GSP3202
Product type	Stands and tripods
Type	Speaker stands
Tubing material	Steel
Tubing colour	Black
Tubing surface	Powder coated
Min height:	900 mm
Max height	1500 mm
Height adjustment	Clamp with safety pin
Base type	3-point
Base material	Cast iron
Base edge length	292.5 mm
Lower connector	M20
Tubing diameter	42 mm/35 mm
Max. load	50 kg
Interchangeable rings	1 x 25 mm, 1 x 30 mm
Black ring pack included	Yes
Weight	6.5 kg
Additional information	Including acoustic isolation spikes



SPEAKER STANDS



SP WMBS 20 B / SP WMBS 20 W

Tilt and Swivel Wall Mount For Speakers up to 20 kg

Product number	GSPWMBS20B / W
Product type	Stands and tripods
Type	Speaker Stands
Material	Steel
Surface	Powder coated
Colour	Black / white
Max. load	20 kg
Weight	1.35 kg
Additional information	incl. universal mounting plate



160° swivel,
0 to 40° down tilt,
continuously variable



Easily readable tilt
angle scale



6 mm wall plate with
safety rope eyelet



SP WMBS 30 B / SP WMBS 30 W

Tilt and Swivel Wall Mount for Speakers up to 30 kg

Product number	GSPWMBS30B / W
Product type	Stands and tripods
Type	Speaker stands
Material	Steel
Surface	Powder coated
Colour	Black / white
Max. load	30 kg
Weight	1.8 kg
Additional information	incl. universal mounting plate



160° swivel,
0 to 40° down tilt,
continuously variable



Easily readable tilt
angle scale



6 mm wall plate with
safety rope eyelet

ACCESSORIES SPEAKER STANDS



SA CC 35 B

Cable Clips Speaker Pole, 35 mm

Made from tough, long-lasting ABS, the Gravity 35 mm cable clips are designed for a firm, secure fit to speaker stands and subwoofer poles. They keep your cables neat and safely fixed in a large 24 x 16 mm outside duct and are sold in pairs.



Product number	GSACC35B
Product type	Stands and tripods
Material	ABS plastic
Colour	Black
Suitable for tube diameter	34 - 35 mm
For number of cables	2 pcs.
Max. cable diameter	24 x 16 mm
Weight	0.011 kg



SAT 36 B

Mounting Fork Adjustable T-Bar for Speaker Stands

The Gravity T-Bar facilitates mounting two loudspeakers on a single stand. It is made of heavy-duty steel with a black powder-coating finish and securely attaches to all 35 mm poles. Width is fully adjustable from 31 to 49 cm.



Product number	GSAT36B
Product type	Stands and tripods
Type	Speaker stands
Material	Steel
Colour	Black
Surface	Powder coated
Suitable for tube diameter	35 mm
Adjustable width	310 - 490 mm
Fitting	Screw clamp
Max. load	2 x 25 kg
Interchangeable rings	1 x 25 mm
Black ring pack included	Yes
Additional information	Assembly tool
Weight	1.4 kg

ACCESSORIES SPEAKER STANDS

SA VESA 1

35 mm Pole Mount LCD TV Monitor Bracket

This universal bracket is suitable for all flat screen monitors with VESA standard mounting hole patterns from 75 x 75 to 400 x 400 and securely clamps to 35 mm speaker poles. The heavy duty steel construction with black powder coating finish has a maximum load capacity of 30 kg and comes complete with sets of M8 and M6 monitor mounting screws.

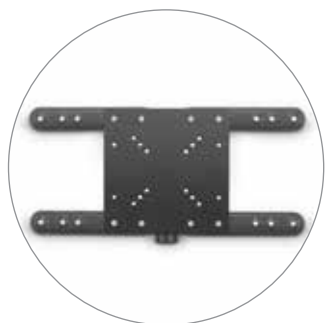

Product number	GSAVES1
Product type	Stands and tripods accessories
Type	Universal monitor mount
Material	Steel
Colour	Black
Suitable for tube diameter	35 mm
Max. load	30 kg
Suitable for VESA dimensions	200 x 200, 400 x 400, 100 x 100, 200 x 100, 300 x 300, 400 x 200, 75 x 75
Dimensions base plate	240 x 240 mm
Material thickness base plate	3 mm
Length extensions	240 mm
Width extensions	45 mm
Material thickness extensions	2 mm
Interchangeable rings	1 x 25 mm
Black ring pack included	Yes
Accessories (included)	4 x extensions, 4 x M6 screws, 4x distance holders, Base plate with 35 mm pole mount and locking screw, 4 x M8 screws, 8x M6 countersunk screws
Weight	2.71 kg



WB 123 SET 1 B

Round Cast Iron Base and Weight Plate Set for M20 Poles



Product number	GWB123SET1B
Gravity round cast iron base for M20 poles	GWB123B
Product type	Stands and tripod accessories
Pedestal material	Die-cast iron
Diameter	450 mm
Colour	Black
Threaded connector	M20 female
Additional information	5 kg extra weight plate available
Weight	10 kg
Extra weight plate for round base	GWB123WPB
Material	Cast iron
Colour	Black
Surface	Powder coated
Diameter	350 mm
Features	Weight plate can be mounted quickly and without tools
Weight	5 kg

ACCESSORIES SPEAKER STANDS

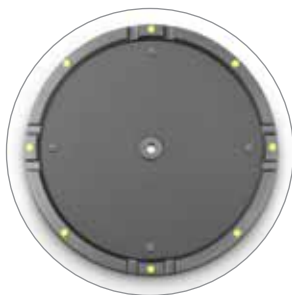

WB 123 B / W

Round Cast Iron Base for M20 Poles

Product number	GWB123B / GWB123W
Product type	Stands and tripod accessories
Type	Base
Material	Die-cast iron
Surface	Powder coated
Colour	Black / White
Diameter	450 mm
Threaded connector	M20 female
Additional information	5 kg extra weight plate available
Weight	10 kg

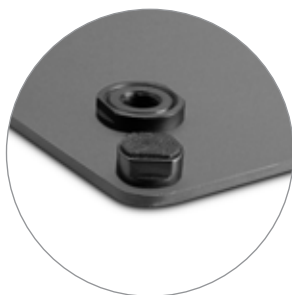

WB 431 B

Square Base for Off-Centre Weight Attachment

Product number	GWB431B
Product type	Stands and tripod accessories
Type	Base
Material	Steel
Surface	Powder coated
Colour	Black
Width	563 mm
Depth	15 mm
Height	563 mm
Weight	13.8 kg





SA VARI-TILT®

Variable Speaker Tilt Adapter

Product number	GSAVARITILT
Product type	Stands and tripod accessories
Colour	Black
Material	Steel
Surface	Powder coated
Suitable for tube diameter	35 mm
Tilt angle	0 - 15 °
Length	190 mm
Max. load	30 kg
Interchangeable rings	1 x 25 mm
Black ring pack included	Yes
Weight	0.6 kg



SF 36 Z 38 M

Reducer Flange from 36 mm to 3/8" Male

Product number	GSF36Z38M
Product type	Stands and tripod accessories
Colour	Black
Material	Steel
Surface	Powder coated
Suitable for tube diameter	35 mm
Threaded connector	3/8" x 12 mm
Type of adjustment	Screw clamp
Length	100 mm
Interchangeable rings	1 x 25 mm
Black ring pack included	Yes
Weight	0.49 kg



SA FIXTILT 5

5° Speaker Tilt Adapter

Product number	GSAFIXTILT5
Product type	Stands and tripod accessories
Colour	Black
Material	Steel
Surface	Powder coated
Suitable for tube diameter	35 mm
Tilt angle	5 °
Length	190 mm
Max. load	30 kg
Interchangeable rings	1 x 25 mm
Black ring pack included	Yes
Weight	0.5 kg



SF 36 M 6 M

Reducer Flange from 36 mm to M6 Male

Product number	GSF36M6M
Product type	Stands and tripod accessories
Colour	Black
Material	Steel
Surface	Powder coated
Suitable for tube diameter	35 mm
Threaded connector	M6 x 12 mm
Type of adjustment	Screw clamp
Length	100 mm
Interchangeable rings	1 x 25 mm
Black ring pack included	Yes
Weight	0.49 kg

ACCESSORIES SPEAKER STANDS



SF 36 M 10 M

Reducer Flange from 36 mm to M10 Male

Product number	GSF36M10M
Product type	Stands and tripod accessories
Colour	Black
Material	Steel
Surface	Powder coated
Suitable for tube diameter	35 mm
Threaded connector	M10
Type of adjustment	Screw clamp
Length	100 mm
Interchangeable rings	1 x 25 mm
Black ring pack included	Yes
Weight	0.49 kg



SF 36 M 10 F

Reducer Flange from 36 mm to M10 Female

Product number	GSF36M10F
Product type	Stands and tripod accessories
Colour	Black
Material	Steel
Surface	Powder coated
Suitable for tube diameter	35 mm
Threaded connector	M10 Thread
Type of adjustment	Screw clamp
Length	100 mm
Interchangeable rings	1 x 25 mm
Black ring pack included	Yes
Weight	0.47 kg
Accessories (included)	Bolt M10 x 25 / washer



SF 36 16 M

Reducer Flange from 36 mm to 16 mm Male

Product number	GSF3616M
Product type	Stands and tripod accessories
Colour	Black
Material	Steel
Surface	Powder coated
Suitable for tube diameter	35 mm
Reduced to	16 mm
Type of adjustment	Screw clamp
Length	140 mm
Interchangeable rings	1 x 25 mm
Black ring pack included	Yes
Weight	0.53 kg



SF 36 T 28 F

Reducer Flange from 36 mm to TV28 Female

Product number	GSF36T28F
Product type	Stands and tripod accessories
Colour	Black
Material	Steel
Surface	Powder coated
Suitable for tube diameter	35 mm
Threaded connector	28 mm (TV28)
Type of adjustment	Screw clamp
Length	100 mm
Interchangeable rings	1 x 25 mm
Black ring pack included	Yes
Weight	0.72 kg

your amp sound to go



ACOUSTIC POCKET AMP

PORTABLE PREAMP FOR ACOUSTIC GUITARS
ALSO AVAILABLE FOR ELECTRIC AND BASS GUITARS

As a serious musician, you know how important it is to preserve your signature sound no matter where you go and where you're at – on stage, at rehearsal or in the studio. Now you can! Introducing the Palmer Pocket Amp Series. Although small and handy, make no mistake, these are no toys but rather serious tools providing you with vast sound possibilities. Be true to your sound, and now take your sound to go.

palmer-germany.com/POCKETAMP



POCKET AMP MK2



BASS POCKET AMP



Palmer® is a registered brand of the Adam Hall Group.





LIGHTING STANDS

Featuring premium materials and ultra durable construction, Gravity lighting stands ensure years of reliable service. They are available in classic tripod versions or with a heavy low-profile steel base for unobtrusive placement. Gravity lighting stands provide secure adjustment and maximum stability to safely put your fixtures where you need them.

LIGHTING STANDS

LS 331 B / LS 431 B

Lighting stand with Square Steel Base

The LS 331 B lighting stand features a large heavy steel base providing a firm footing and a single extension for a maximum height of 2.4 m. The 35 mm pole includes a female threaded M10 insert, the base tube has a male M20 end. Two integrated base handles facilitate transport.

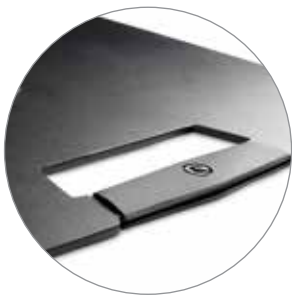

Product number	GLS331B / GLS431B
Product type	Stands and tripods
Type	Lighting stands
Tube material	Steel
Tubing colour	Black
Tubing surface	Powder coated
Min height:	1420 mm
Max height	2420 mm
Transport length	1420 mm
Height adjustment	Set screw and safety pin
Number of extensions	1
Base material	Steel
Material of height adjustment	Steel
Tube diameter	35 mm
Dimensions Base (W x H x D)	563 x 563 x 15 mm
Base weight	14 kg
Interchangeable rings	1 x 25 mm
Black ring pack included	Yes
Max. load capacity	20 kg
Weight	17.8 kg



Also available with multiple threads for off-centre mounting (LS 431 B).

LS VARI-POLE® 01 B

Telescoping Pole with 210 - 370 cm length

Made of lightweight, black anodized aluminium tubing with a secure locking mechanism, the Gravity VARI-POLE® extends from 210 cm to 370 cm and quickly mounts between floors and ceilings. It is held in place by pressure, and strong rubber on both sides for a variety of other applications.

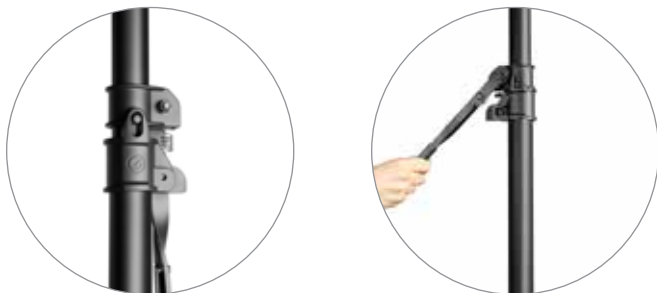

Product number	GLSVARIPOLE01B
Product type	Stands and tripods
Type	Clamping rod
Material	Aluminium
Colour	Black
Tubing surface	Anodized
Connection Surface	Powder coated
Transport length	2100 mm
Clamping Range	2100 - 3700 mm
Upper Tube Diameter	40 mm
Lower Tube Diameter	45 mm
Weight	2.2 kg



LIGHTING STANDS

LS VP SET 1

Set of 4 Telescopic Poles in Transport Bag

This set includes 4 Gravity Vari-Poles® made of lightweight, black anodized aluminium tubing with continuously variable length from 210 cm to 370 cm. They come in a dedicated heavy duty Vari-Pole® carry bag of water-repellent 600D nylon with 10 mm padding providing protection from bumps and dents. Padded dividers keep the clamping poles separate to prevent scratches, an interior mesh pocket offers plenty of space for accessories.



Product number	GLSVPSET1
Gravity transport bag	GBGVARIPOLE4B
Product type	Stands and tripods accessories
Type	Transport bag
For number of stands	4
Colour	Black
Material	Nylon 600D
Thickness of the padding	10 mm
Latch	Zip
Width	2150 mm
Height	430 mm
Depth	120 mm
Weight	14.5 kg
Gravity lighting stand	GLSVARIPOLE01B
Product type	Stands and tripods
Type	Clamping rod
Material	Aluminium
Colour	Black
Tubing surface	Anodized
Connection Surface	Powder coated
Transport length	2100 mm
Clamping Range	2100 - 3700 mm
Upper Tube Diameter	40 mm
Lower Tube Diameter	45 mm
Weight	2.2 kg



LS TBTV 17

Lighting stand with T-Bar, Small

The GLSTBTV17 is a classic tripod lighting stand with twin extensions, made from thick walled, yet lightweight powder coated steel tubing. The die-cast aluminium leg collar has been completely redesigned to provide superior durability and longevity.

The unbreakable height adjustment collars are made of die-cast aluminium for additional strength. The ergonomic set screw knobs are made from high grade ABS with a soft touch, non-slip thermoplastic coating for comfortable handling. The stand includes a T-Bar with an ergonomically formed and rubberised T-Bar – making the T-Bar not only easier to handle and carry but also better looking than regular stands.

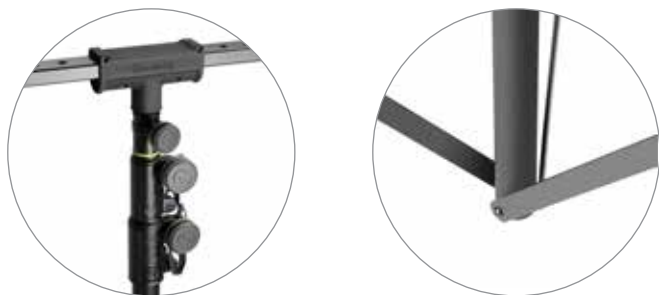

Product number	GLSTBTV17
Product type	Stands and tripods
Type	Lighting stands
Stand material	Steel
Truss material	Steel
Stand surface	Powder coated
Crossbar surface	Powder coated
Stand colour	Black
Number of extensions	2
Min. height	1100 mm
Max height	2500 mm
Max. load	30 kg
Holding fixture for TV spigot	Yes
TV spigot	17 mm
Crossbar length	950 mm
Weight	5.8 kg



LIGHTING STANDS

LS TBTV 28

Lighting stand with T-Bar, Large

The GLSTBTV28 is a classic tripod lighting stand with twin extensions, made from thick walled, yet lightweight powder coated steel tubing. The die-cast aluminium leg collar has been completely redesigned to provide superior durability and longevity. The unbreakable height adjustment collars are made of die-cast aluminium for additional strength and feature safety pins to securely lock the extensions in place. The ergonomic set screw knobs are made from high grade ABS with a soft touch, non-slip thermoplastic coating for comfortable handling. The stand includes a T-Bar with an ergonomically formed and rubberized T-Bar - making the T-Bar not only easier to handle and carry but also better looking than regular stands.

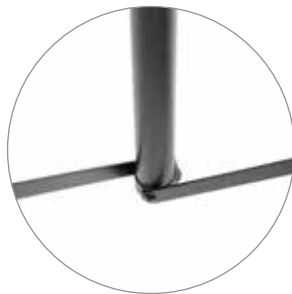

Product number	GLSTBTV28
Product type	Stands and tripods
Type	Lighting stands
Stand material	Steel
Truss material	Steel
Stand surface	Powder coated
Crossbar surface	Powder coated
Stand colour	Black
Number of extensions	2
Min. height	1450 mm
Max height	3250 mm
Transport length	1450 mm
Max. load	50 kg
Holding fixture for TV spigot	Yes
TV spigot	28 mm
Crossbar length	1220 mm
Weight	9.2 kg



SP 5522 B

Twin Extension Speaker and Lighting Stand, tall Version

The SP 5522 B is a classic tripod speaker and lighting stand made from thick walled, yet lightweight powder coated steel tubing with a load capacity of 30 kg and twin extensions for a maximum height of 3 m. The die-cast aluminium leg collar has been completely redesigned to provide superior durability and longevity. The unbreakable height adjustment collars are made of steel for additional strength featuring safety pins to securely lock the extensions in place. The ergonomic set screw knobs are made from high grade ABS with a soft touch, non-slip thermoplastic coating for comfortable handling. A set of black coding rings is included with the SP 5522 B, additional ring packs are available in a wide array of colours for instant personalization.



Product number	GSP5522B
Product type	Lighting stands
Tube material	Steel
Tube colour	Black
Tube surface	Powder coated
Max height	3000 mm
Min height:	1110 mm
Height-adjustable	Yes
Material of height adjustment	Steel
Number of extensions	2
Thread stand	M10
Base type	Tripod
Base material	Die-cast aluminium
Tube diameter	35 mm
Max. load	30 kg
Interchangeable rings	5 x 30 mm
Black ring pack included	Yes
Weight	6.3 kg



LIGHTING STANDS



LS FLOORX B

Foldable Floor Stand for Spots

The LS FLOORX B is a compact stand for placing light fixtures on the stage floor. The folding design of powder coated steel with ergonomic locking screw enables space saving storage, hefty rubber feet prevent marring of the floor while providing a secure grip.



Product number	GLSFLOORXB
Product type	Stands and tripods
Type	Lighting stands
Material	Steel
Colour	Black
Surface	Powder coated
Footprint	385 x 355 mm
Height	40 mm
Max. load capacity	14 kg
Black ring pack included	Yes
Weight	0.4 kg



be light years ahead

Explore a whole new universe of top modern lighting to electrify your audiences. The new powerful yet energy efficient Cameo OPUS® series of moving heads has landed. LED from outer space.



OPUS® SP5

HIGH CLASS
PROFILE MOVING HEAD
500 W / 15.000 lm



OPUS® SP5 FC

HIGH CLASS
PROFILE MOVING HEAD
300 W / 9.000 lm



OPUS® S5

HIGH CLASS
SPOT MOVING HEAD
380 W / 17.500 lm

 **cameo**®

DESIGNED & ENGINEERED
IN GERMANY

step into the future at:
cameolight.com/OPUS-SERIES

Cameo®
is a brand of  **adam hall** experience
event technology

SOUND
TECHNOLOGY

LIGHT
TECHNOLOGY

STAGE
EQUIPMENT

HARDWARE
FOR FLIGHTCASES

share the experience at
adamhall.com

ACCESSORIES LIGHTING STANDS



SA CC 35 B

Cable Clips Speaker Pole, 35 mm

Made from tough, long-lasting ABS, the Gravity 35 mm cable clips are designed for a firm, secure fit to speaker stands and subwoofer poles. They keep your cables neat and safely fixed in a large 24 x 16 mm outside duct and are sold in pairs.



Product number	GSACC35B
Product type	Stands and tripods
Material	ABS plastic
Colour	Black
Suitable for tube diameter	34 - 35 mm
For number of cables	2 pcs.
Max. cable diameter	24 x 16 mm
Weight	0.011 kg



LS TB 01

Universal T-Bar for 35 mm Stands

Product number	GLSTB01
Product type	Stands and tripod accessories
Type	Lighting stands
Colour	Black
Material	Die-cast aluminium
Surface	Powder coated
Fitting	36 mm clamp
Length	1235 mm
Max. load capacity	50 kg
Weight	1.7 kg

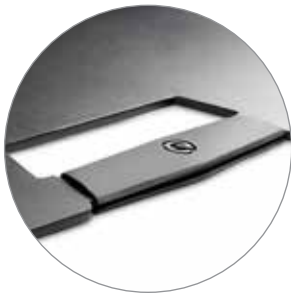

WB 431 B

Square Base for Off-Centre Weight Attachment

Product number	GWB431B
Product type	Stands and tripod accessories
Type	Base
Material	Steel
Surface	Powder coated
Colour	Black
Width	563 mm
Depth	15 mm
Height	563 mm
Weight	13.8 kg



GOODBYE **CABLES.**
HELLO **BATTERY!**

ZENIT® B60

iDMX® APP



ZENIT® B60 / iDMX® CORE & APP



With the Cameo **ZENIT® B60** and the **iDMX® CORE & APP** we've combined **professional yet affordable lighting performance, compact dimensions, user-friendly control** and **high battery power** to create an **extremely versatile** lighting solution so you can easily turn your visions into reality. The **IP65** rated ZENIT® B60 sports a **LG Chem® super-capacity lithium-ion battery, 4x15 W** long-life **Cree® RGBW LEDs** and a **set of light shaping diffusers** making it suitable for even the most eccentric of lighting projects. Say goodbye to cables and gain efficiency and profitability by going **100% wireless**. Say hello to the new ZENIT® B60 and iDMX® CORE & APP.



iDMX® CORE

DESIGNED & ENGINEERED IN GERMANY
cameolight.com

cameo
colours of light

W-DMX™ is a trademark of Wireless Solution Sweden AB. The Apple® Logo is a trademark of Apple Inc. Android® is a trademark of Google Inc.

Cameo®
is a brand of  **adam hall** experience
event technology

share the experience at
adamhall.com





KEYBOARD STANDS

Gravity keyboard stands and add-on tiers are designed for safe support and easy portability. Including multi-adjustable T-style and single or double X-braced models, they are made of heavy duty steel with reinforced joints, durable powder coating and grippy pads. Gravity keyboard stands provide easy setup and height adjustment for sitting or standing playing positions.

KEYBOARD STANDS

FEATURES



Black rings and pads included



Vari-Foot®
Compensates for uneven ground



Ergonomic quick release clamp



Reinforced tubes for superior strength and longevity

KS TS 01 B

Keyboard Stand Table

This keyboard stand with table-like construction offers superior stability making it particularly suitable for heavy keyboards. It is height-adjustable in small incremental steps, making the stand suitable for both seated and standing applications. The legs can be fitted in two basic configurations – either perpendicular to the vertical structure or angled outwards slightly – the latter configuration offers additional stability and more leg room. The top rests can be adjusted to the width of the keyboard and can also be angled in small incremental steps over a range of 360 degrees. All in all, this solid steel construction comprises all features possible in such a design without compromise.

For transport, both the legs and the top rest can be folded inwards, resulting in a very compact transport height.

The stand includes one Vari-Foot® leveling foot to compensate for ground irregularities.



Product number	GKSTS01B
Product type	Stands and tripods
Type	Keyboard stands
Material	Steel
Surface	Powder coated
Colour	Black
Decks	1
Max. support depth	340 mm
Support arm spacing adjustment range	230 - 730 mm
Min height:	735 mm
Max height	1155 mm
Width	950 mm
Width (when folded)	1300 mm
Max load (support)	90 kg
Interchangeable rings	6 x 20 mm, 6 x 30 mm
Black ring pack included	Yes
Weight	6.9 kg

KEYBOARD STANDS



KSX 1

Keyboard stand X-Form Single

Product number	GKSX1
Product type	Stands and tripods
Type	Keyboard stands
Material	Steel
Surface	Powder coated
Colour	Black
Decks	1
Max. support depth	400 mm
Min height:	100 mm
Max height	900 mm
Max load (support)	55 kg
Interchangeable rings	1 x 15 mm, 4 x 20 mm, 4 x 30 mm
Black ring pack included	Yes
Weight	2.98 kg



KSX 2 / KSX 2 W

Keyboard stand X-Form Double

Product number	GKSX2 / W
Product type	Stands and tripods
Type	Keyboard stands
Material	Steel
Surface	Powder coated
Colour	Black / white
Decks	1
Max. support depth	400 mm
Min height:	100 mm
Max height	900 mm
Max load (support)	65 kg
Interchangeable rings	4 x 20 mm, 4 x 30 mm, 1 x 15 mm
Black ring pack included	Yes
Weight	4.45 kg

KSX 2 T

Tilting tier for GKSX keyboard Stands

Tilting tier for Gravity X-type keyboard stands. Upgrade your keyboard stand by attaching a second tier for an additional keyboard. The universal and easy to use mounting and adjustment options require no tools whatsoever.

The tilting angle of the tier is adjustable in fine incremental steps – markings on both arms help in finding the right angle. The tier is compatible with tubes measuring an inner diameter of at least 20 mm.



Product number	GKSX2T
Product type	Stands and tripods
Type	Keyboard stands
Material	Steel
Surface	Powder coated
Colour	Black
Decks	1
Support arm spacing adjustment range	490 - 740 mm
Max height	300 mm
Max load (support)	15 kg
Suitable for tube diameter	20 mm
Interchangeable rings	2 x 15 mm, 2 x 30 mm
Black ring pack included	Yes
Weight	1.8 kg





MUSIC STANDS

Featuring friction-based height and tilt adjustment, the Gravity heavy duty orchestra-style music stand has been designed for easy handling and stability.

MUSIC STANDS

FEATURES

✓ 
Black replacement rings **included**.



Aluminium plate



Foolproof operation,
knob free tilt and height
adjustment



Stable steel base



Stable tripod
construction



Easy and stable plate
mounting



Heavy duty height
adjustment

NS 411

Music Stand Classic

This music stand is based on a classic design. Attention was given to details such as the support joint which is made of die-cast material for a precise fit, the base connector and the height adjustment. Utilising the Gravity-typical ergonomic set screw knobs - made from high-grade ABS with a soft touch, non-slip thermoplastic coating and heavy duty metal joints, this stand is designed to withstand harsh treatment in the everyday life of a musician.

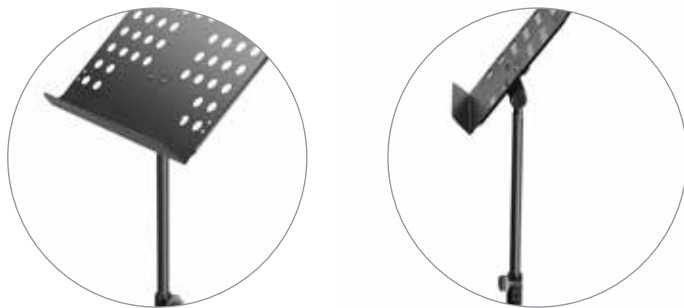

Product number	GNS411
Product type	Stands and tripods
Type	Music stand
Music desk type	Perforated music desk
Stand material	Steel
Stand surface	Powder coated
Stand colour	Black
Support material	Steel
Support surface	Powder coated
Support colour	Black
Support width	340 mm
Support height	475 mm
Min. height	660 mm
Max. height	1200 mm
Weight	3.9 kg



MUSIC STANDS

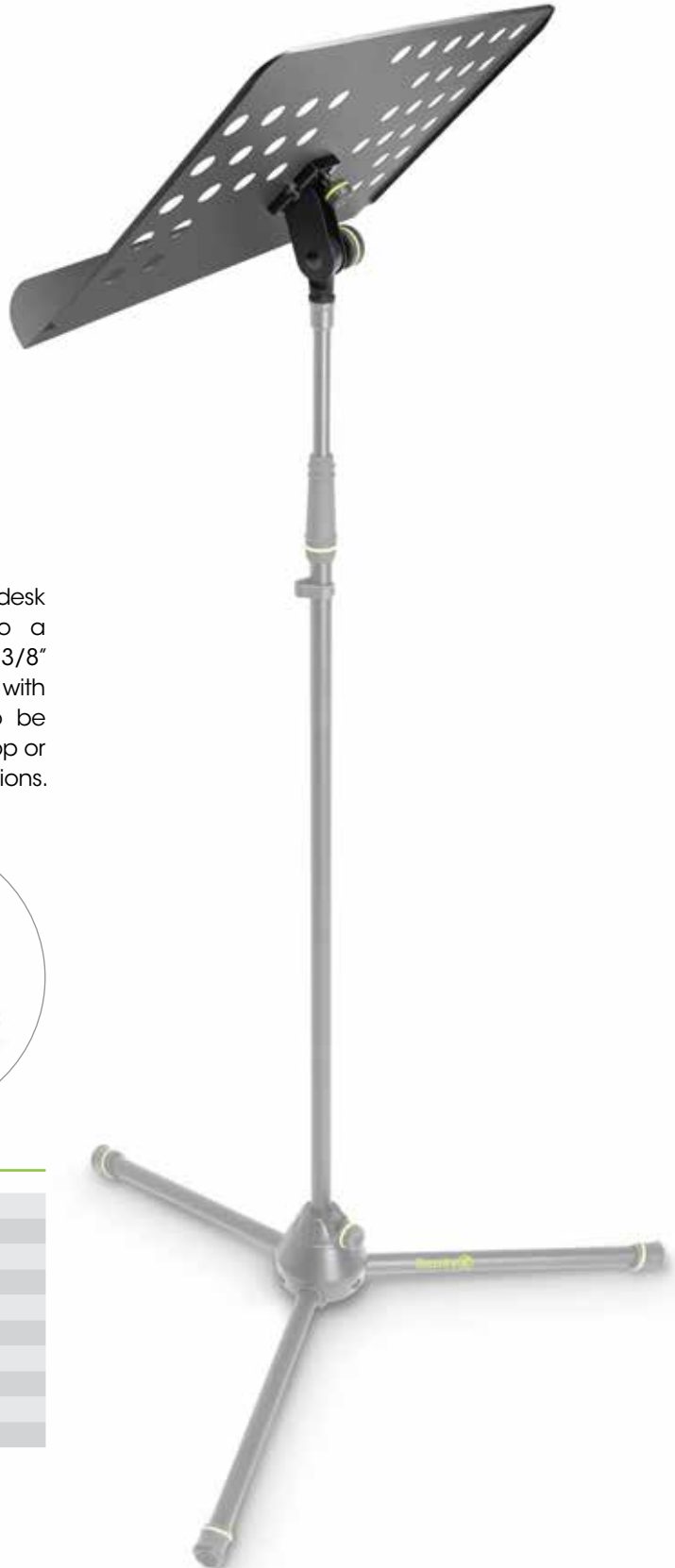

NS MS 01

Music stand desk for Microphone Stands

This simple but smart adaptation of a music stand desk allows you to convert any microphone stand into a music stand. This music desk is equipped with a 3/8" female thread and can be attached to any product with a male counterpart thread. The desk can thus also be attached to various kinds of mic holders such as table-top or conventional stands – opening a whole new world of options.



Product number	GNSMS01
Product type	Stands and tripods
Type	Music stand
Music desk type	Perforated music desk
Support material	Steel
Support surface	Powder coated
Support colour	Black
Support width	340 mm
Support height	475 mm
Weight	1.8 kg

NS ORC 1

Music Stand Orchestra

The NS ORC 1 is a rugged orchestra-style music stand designed for ultimate handling convenience. Height and support tilt adjustment rely on frictional force and do not require any set screws. All frictive parts are engineered for zero wear. The stand of powder coated steel features a lightweight 50 x 33.5 cm aluminium support.

Product number	GNSORC1
Product type	Stands and tripods
Type	Music stand
Music desk type	Panel
Stand material	Aluminium
Stand surface	Chromium plated, powder coated
Stand colour	Chromium
Support material	Aluminium
Support surface	Powder coated
Support colour	Black
Support width	500 mm
Support height	335 mm
Min. height	640 mm
Max. height	1200 mm
Transport length	1180 mm
Max. load capacity	2.5 kg
Interchangeable rings	1 x 20 mm
Black ring pack included	Yes
Weight	2.7 kg

NS ORC 1 L

Tall Music Stand Orchestra

Product number	GNSORC1L
Product type	Stands and tripods
Type	Music stand
Music desk type	Panel
Stand material	Steel
Stand surface	Chromium plated, powder coated
Stand colour	Black
Support material	Aluminium
Support surface	Powder coated
Support colour	Black
Support width	500 mm
Support height	335 mm
Height	335 mm
Min. height	655 mm
Max. height	1500 mm
Transport length	1195 mm
Max. load capacity	2.5 kg
Black ring pack included	Yes
Weight	2.86 kg



MUSIC STANDS

NS ORC 2

Music Stand Orchestra with Perforated Desk

The NS ORC 2 orchestra music stand features a perforated sheet music desk of steel and heavy tripod base. It provides convenient no-knob friction height and desk tilt adjustment for use when seated or standing.

Product number	GNSORC2
Product type	Stands and tripods
Type	Music stand
Music desk type	Perforated music desk
Stand material	Aluminium
Stand surface	Chromium plated, powder coated
Stand colour	Chromium plated
Support model	Panel
Support material	Steel
Support surface	Powder coated
Support colour	Black
Support width	500 mm
Support height	335 mm
Min. height	640 mm
Max. height	1200 mm
Transport length	1180 mm
Max. load capacity	2.5 kg
Interchangeable rings	1 x 20 mm
Black ring pack included	Yes
Weight	3.5 kg

NS ORC 2 L

Tall Music Stand Orchestra with Perforated Desk

Product number	GNSORC2L
Product type	Stands and tripods
Type	Music stand
Music desk type	Perforated music desk
Stand material	Steel
Stand surface	Chromium plated, powder coated
Stand colour	Black
Support material	Steel
Support surface	Powder coated
Support colour	Black
Support width	500 mm
Support height	335 mm
Min. height	655 mm
Max. height	1500 mm
Transport length	1195 mm
Max. load capacity	2.5 kg
Interchangeable rings	1 x 20 mm
Black ring pack included	Yes
Weight	3.66 kg







GUITAR STANDS

With guitar racks for multiple instruments, folding stands and wall mount hangers Gravity has got guitar and bass players covered. Smart details such as our ingenious "Neck Hug" yoke mechanism and specially formulated rubber padding ensure your instrument stays where you put it. Gravity guitar stands are suitable for acoustic, electric and bass guitars.



GUITAR STANDS



Folds up flat for transport and storage



Adjustable yokes with rubber padding



Straightforward, rock solid construction



Foam padding

VARI-G®

Guitar Racks for 3 to 9 Instruments

Designed for all acoustic, electric and bass guitars, Gravity guitar racks are available in three versions accommodating 3, 5, 7 or 9 instruments. They are made of heavy-duty steel tubing with a black powder coating finish. Holding the necks firmly and securely the adjustable soft touch yokes are padded and detachable. The rails supporting the guitar bodies are covered in specifically formulated foam to prevent dents and scratches. Quick to set up and space saving, the Gravity guitar racks fold up flat for easy transport and storage.

Product number	GGSMG03	GGSMG05	GGSMG07	GGSMG09
Product type	Stands and tripods	Stands and tripods	Stands and tripods	Stands and tripods
Type	Guitar stand	Guitar stand	Guitar stand	Guitar stand
Material	ABS plastic, TPU, EVA, steel	ABS plastic, TPU, EVA, steel	ABS plastic, TPU, EVA, steel	ABS plastic, TPU, EVA, steel
Surface	Powder coated, Soft-touch	powder coated, Soft-touch	powder coated, Soft-touch	Soft-touch, powder coated
Colour	Black	Black	Black	Black
Suitable for	Acoustic guitars, bass guitar, electric guitars	Acoustic guitars, bass guitar, electric guitars	Acoustic guitars, bass guitar, electric guitars	Acoustic guitars, bass guitar, electric guitars
Number of guitars	3	5	7	9
Height	780 mm	780 mm	780 mm	780 mm
Depth	430 mm	430 mm	430 mm	430 mm
Dimensions When Folded (W x H x D)	400 x 780 x 80 mm	600 x 780 x 80 mm	800 x 780 x 80 mm	1040 x 780 x 80 mm
Interchangeable rings	4 x 25 mm, 2 x 20 mm	4 x 25 mm, 2 x 20 mm	4 x 25 mm, 2 x 20 mm	4 x 25 mm, 2 x 20 mm
Black ring pack included	Yes	Yes	Yes	Yes
Weight	2.85 kg	3.2 kg	3.9 kg	4.2 kg

GUITAR STANDS



Folds up flat for transport and storage



Soft rubber backrest and EVA padding



Straightforward, rock solid construction



Two angles of splay

Solo-G

A-Frame Guitar Stands for Acoustic and Classical Guitars

The solo-G series consists of 3 stands for acoustic and classical guitars, for electric and bass guitars and a universal design that accommodates most body shapes. The A-frame stands are made of heavy-duty steel tubing with black powder coating finish, soft rubber backrest and EVA support arm padding to protect the instrument's finish and nonslip rubber feet. Providing two splay angle options, the tilt back Solo-G design folds up to compact dimensions nicely for easy portability.

Product number	GGSA01A	GGSA01E	GGSA01U
Product type	Stands and tripods	Stands and tripods	Stands and tripods
Type	Guitar stands	Guitar stands	Guitar stands
Material	Steel	Steel	Steel
Surface	Powder coated	Powder coated	Powder coated
Colour	Black	Black	Black
Suitable for	Acoustic guitars	Electric guitars and bass guitars	Acoustic guitars, electric guitars and bass guitars
Interchangeable rings	4 x 25 mm	4 x 25 mm	4 x 25 mm
Weight	1.21 kg	1.3 kg	1.3 kg

GUITAR STANDS

GS 01 NHB

Foldable Guitar Stand with Neckhug

The GS 01 NHB is a rugged yet elegant folding guitar stand for acoustic, electric and bass guitars. It is easily height adjustable up to 108 cm and features Gravity's ingenious "Neck-Hug" technology.

The swivel mechanism automatically locks the guitar neck in the yoke to prevent slipping or falling out. The locking wings open again when the instrument is lifted from the stand. The stand's protective padding prevents dents and dings and does not mar the guitar's finish.

Product number	GGS01NHB
Product type	Stands and tripods
Type	Guitar stand
Material	Steel
Colour	Black
Surface	Powder coated
Suitable for	Electric guitars, acoustic guitars, bass guitars
Number of guitars	1
Width	500 mm
Min. height	680 mm
Max. height	1080 mm
Depth	400 mm
Interchangeable rings	4 x 25 mm
Black ring pack included	Yes
Weight	1.654 kg



Automatically secures the guitar



Innovative Neck-Hug technology



Quick release clamp for easy setup and adjustment

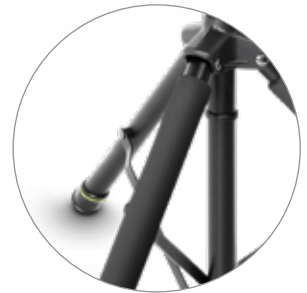

Foam padding



GS 01 WMB

Wall Mount Guitar Hanger with Neckhug

Product number	GG01WMB
Product type	Stands and tripods
Type	Guitar stand
Material	Die-cast aluminium / plastic
Colour	Black
Surface	Powder coated
Suitable for	Acoustic guitars, bass, electric guitars
Number of guitars	1
Width	90 mm
Min. height	70 mm
Depth	140 mm
Interchangeable rings	1 x 25 mm
Black ring pack included	Yes
Weight	0.25 kg



GS 08 WMB

Wall Mount Guitar Hanger

Product number	GG08WMB
Product type	Stands and tripods
Type	Guitar stand
Material	Steel / plastic
Colour	Black
Surface	Rubber coated
Suitable for	Electric guitars, acoustic guitars, bass guitars
Number of guitars	1
Interchangeable rings	1 x 25 mm
Weight	0.168 kg



GUITAR STANDS



GS WMB 01 EB

Wall-Mount Display Guitar Holder

This horizontal guitar holder is designed for eye-catching display of your guitar on walls. The low-profile construction features easy angle adjustment without slippage and padded self-balancing cradles that hold the guitar body and neck securely.



Product number	GGSWMB01EB
Product type	Stands and tripods
Type	Guitar stand
Material	Plastic, aluminium, steel
Colour	Black
Surface	Rubber coated
Main arm length	565 mm
Suitable for	Electric guitars
Max. instrument depth	70 mm
Number of guitars	1
Weight	1 kg



GS WMB 01 AB

Wall-Mount Display Guitar Holder

This horizontal guitar holder is designed for eye-catching display of your guitar on walls. The low-profile construction features easy angle adjustment without slippage and padded self-balancing cradles that hold the guitar body and neck securely.



Product number	GGSWMB01AB
Product type	Stands and tripods
Type	Guitar stand
Material	Plastic, aluminium, steel
Colour	Black
Surface	Rubber coated
Main arm length	565 mm
Suitable for	Acoustic guitars
Max. instrument depth	120 mm
Number of guitars	1
Weight	1 kg



MULTIMEDIA EQUIPMENT

Gravity multimedia stands facilitate integrating your mobile devices into your performance. Smart designs that are highly adjustable accommodate laptops, tablets, smartphones or controllers for convenient operation and easy reach where you need them. Featuring reliable rock-solid construction and thoughtful details, Gravity multimedia stands stow away with compact dimensions for easy transport.

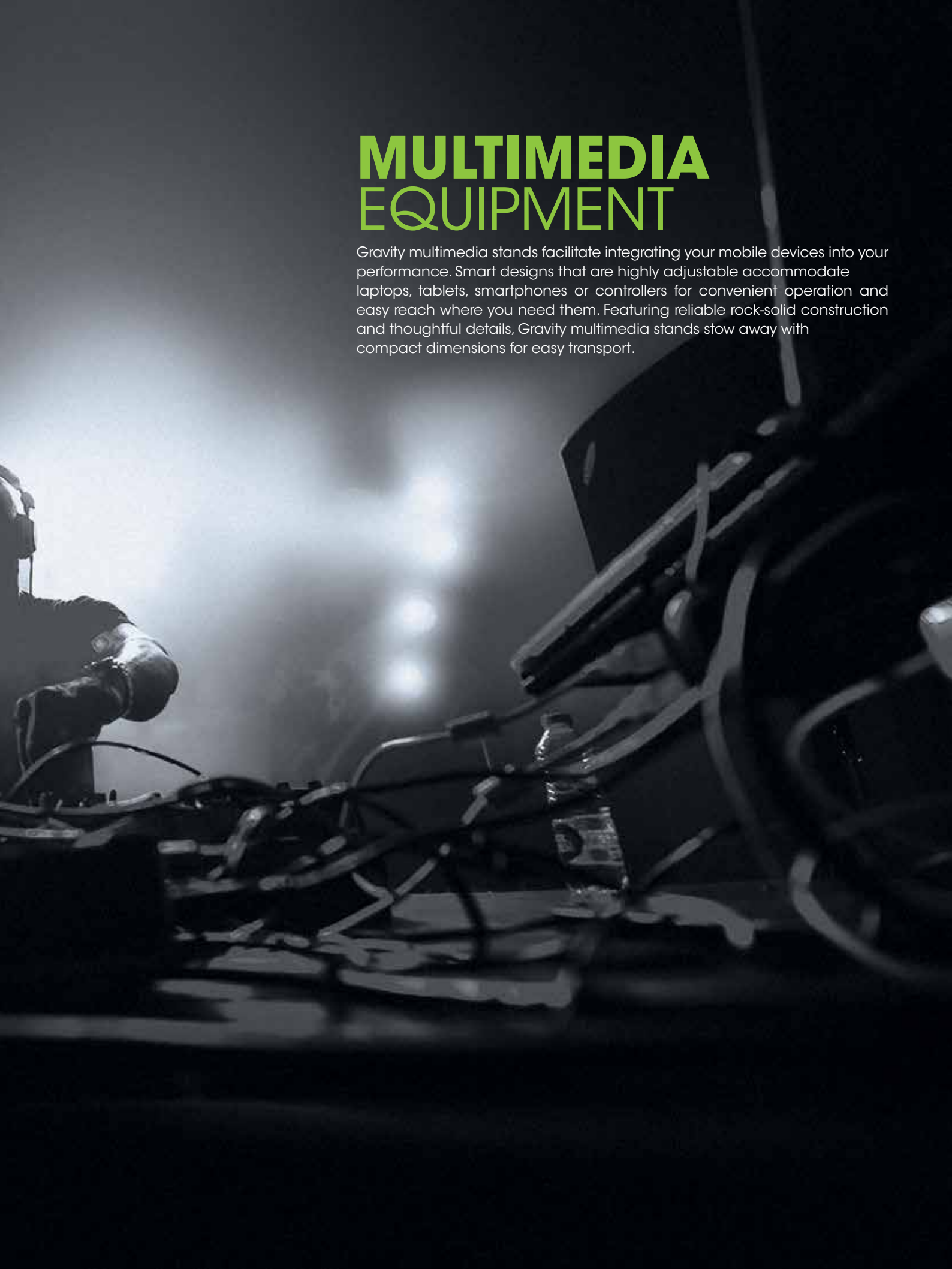

MULTIMEDIA EQUIPMENT

LTS 01 B

Adjustable Laptop and Controller Stand

Revolutionizing the concept of notebook supports, this stand offers the best of all worlds. It is extremely stable yet lightweight and folds to a compact transport size within seconds. Also suitable for controllers the stand features eccentric locking clamps that facilitate quick and secure angle adjustment of both the non-slip rubberized support and base for optimum ergonomic setup. It comes with a table C-clamp and a middle tray which elegantly lock onto the pillar.



Product number	GLTS01B
Product type	Stands and tripods
Type	Laptop stand
Material	Aluminium
Surface	Powder coated
Colour	Black
Depth	280 mm
Width	260 mm
Height	270 mm
Weight	1.6 kg



MULTIMEDIA EQUIPMENT

SA 6131 B

Monitor Mount Tabletop-Mount, Swivel Arm

The SA 6131 B is an elegant steel and die-cast aluminium construction monitor screen mount arm. It is adjustable in all directions and features an ingenious counterbalance design for easy screen height adjustment. The integrated cable management system ensures a clean and uncluttered installation. The producer screen arm ships with desk clamp and grommet for a wide variety of secure mounting options.



Product number	GSA6131B
Product type	Stands and tripods
Type	Other stands and tripods
Material	Aluminium / steel
Colour	Black
Mounting option	Barrier strip / table mount
Suitable for Screens Size	13" - 27"
Number of Screens	1 / 2
Screen weight min.	2 kg
Screen weight max.	9 kg
Suitable for curved screens	Yes
Vesa standard	75 x 75 mm, 100 x 100 mm
Tilt movement	-90° - +90°
Swivel	180°
Rotate	360°
Max. length of arm	527 mm
Height	1400 mm
Height adjustment	Continuous
Cable management	Yes
Weight	3.85 kg



Gas spring and adjustable spring tension gauge

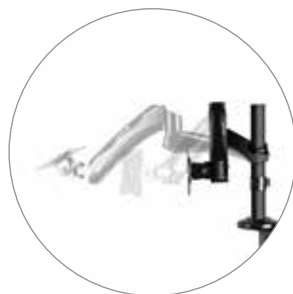

Swivel 180°, tilt -90° / +90°, rotation 360°, adjustable height



Integrated cable management



Table clamp included

HP HTT 01 B

Table-Top Headphones Stand

Designed for both home and professional use, this elegant table-top headphones stand securely holds up to two large sets of headphones. Convenient slots on the holder facilitate convenient and tidy routing and storage of cables or ear buds. The stand features a die-cast aluminium base and tower construction, whereby the holder itself is made of plastic with a rubberised finish.



Product number	GHPHT01B
Product type	Headphone holder
Material	Aluminium, plastic
Colour	Black
Support width	60 mm
Black ring pack included	No
Weight	0.48 kg

MULTIMEDIA EQUIPMENT



HP HMS 01 B / HP HTC 01 B / HP HWMB 01 B

Headphones Holder For Microphone Stand / Table Mount / Wall Mount

Product number	GPHMS01B	GPHTC01B	GPHWMB01B
Product type	Headphone holder	Headphone holder	Headphone holder
Material	Plastic / steel	Plastic / steel	Plastic / steel
Mounting	Microphone stand	Table	Wall
Colour	Black	Black	Black
Support width	60 mm	60 mm	60 mm
Deck depth	100 mm	100 mm	100 mm
Interchangeable rings	1 x 20 mm	1 x 20 mm	No
Black ring set included	Yes	Yes	No
Weight	0.175 kg	0.25 kg	0.2 kg



Nothing
compares
to **U.**

U300[®] SERIES WIRELESS MICROPHONE SYSTEMS

When you're expressing yourself on stage, it's all about you. The wireless U300 allows you to enjoy the freedom of unleashed individual live action. Perform your incomparable voice in the highest quality and even achieve the distinctiveness of your guitar, bass or brass sound. Because nothing compares to U.



LD
SYSTEMS **PRO AUDIO**
IN MOTION

DESIGNED & ENGINEERED
IN GERMANY

EMBRACE YOURSELF AT:
LD-SYSTEMS.COM/U300

LD Systems[®]
is a brand of  **adam hall** experience
event technology

SOUND
TECHNOLOGY

LIGHT
TECHNOLOGY

STAGE
EQUIPMENT

HARDWARE
FOR FLIGHTCASES

share the experience at
adamhall.com



BAGS

Gravity bags offer you an easy and safe transport of your stands. The thick padding and the water repellent material make sure your equipment is absolutely safe.

CARRY BAGS



BG MS 6 B

Transport Bag for 6 Microphone Stands

Product number	GBGMS6B
Product type	Stands and tripod accessories
Type	Transport bag
For number of stands	6
For type of stand	Microphone stand
Colour	Black
Material	Nylon 600D
Thickness of the padding	5 mm
Latch	Zip
Width	1050 mm
Height	330 mm
Depth	330 mm
Weight	1.8 kg



BG MS 6 SB

Transport Bag for 6 Short Microphone Stands

Product number	GBGMS6SB
Product type	Stands and tripod accessories
Type	Transport bag
For number of stands	6
For type of stand	Microphone stand
Colour	Black
Material	Nylon 600D
Thickness of the padding	5 mm
Latch	Zip
Width	680 mm
Height	330 mm
Depth	330 mm
Weight	1.43 kg





BG MS 1 B

Transport Bag for 1 Microphone Stand

Product number	GBGMS1B
Product type	Stands and tripod accessories
Type	Transport bag
For number of stands	1
For type of stand	Microphone stand
Colour	Black
Material	Neoprene
Thickness of the padding	1 mm
Latch	Double zip
Width	1150 mm
Height	120 mm
Depth	25 mm
Weight	0.3 kg
Black ring pack included	No



BG SS 2 B

Transport Bag for 2 Speaker Stands

Product number	GBGSS2B
Product type	Stands and tripod accessories
Type	Transport bag
For number of stands	2
For type of stand	Speaker tripod
Colour	Black
Material	Nylon 600D
Thickness of the padding	15 mm
Latch	Double zip
Width	1070 mm
Height	190 mm
Depth	290 mm
Weight	1.45 kg
Black ring pack included	No



CARRY BAGS



BG SS 2 LB

Transport Bag for 2 Speaker Stands Long

Product number	GBGSS2LB
Product type	Stands and tripod accessories
Type	Transport bag
For number of stands	2
For type of stand	Speaker tripod
Colour	Black
Material	Nylon 600D
Thickness of the padding	15 mm
Latch	Double zip
Width	1200 mm
Height	190 mm
Depth	290 mm
Weight	1.6 kg
Black ring pack included	No



BG SS 2 XLB

Transport Bag for 2 Large Speaker Stands

Product number	GBGSS2XLB
Product type	Stands and tripod accessories
Type	Transport bag
For number of stands	2
For type of stand	Speaker tripod
Colour	Black
Material	Nylon 600D
Thickness of the padding	10 mm
Latch	Double zip
Width	1450 mm
Height	180 mm
Depth	280 mm
Weight	1.86 kg
Black ring pack included	No





BG SS 1 XLB

Transport Bag for 1 Large Speaker Stand

Product number	GBGSSTXLB
Product type	Stands and tripod accessories
Type	Transport bag
For number of stands	1
For type of stand	Speaker tripod
Colour	Black
Material	Nylon 600D
Thickness of the padding	10 mm
Latch	Double zip
Width	1490 mm
Height	170 mm
Depth	150 mm
Weight	1.1 kg
Black ring pack included	No



BG DBLS 331

Transport Bag for 2 Distance Poles

Product number	GBGDBLS331
Product type	Stands and tripod accessories
Type	Transport bag
For number of stands	2
For type of stand	Distance bar
Colour	Black
Material	Nylon 600D
Thickness of the padding	10 mm
Latch	Double zip
Width	1420 mm
Height	120 mm
Depth	140 mm
Weight	0.9 kg
Black ring pack included	No



CARRY BAGS



BG SS 2 MS 2 B

Transport Bag for 2 Speaker and 2 Microphone Stands

Product number	GBGSS2MS2B
Product type	Stands and tripod accessories
Type	Transport bag
For number of stands	4
For type of stand	Speaker tripod, Microphone stand
Colour	Black
Material	Nylon 600D
Thickness of the padding	10 mm
Latch	Zip
Width	1050 mm
Height	450 mm
Depth	180 mm
Weight	2.5 kg
Black ring pack included	No



BG VARI-POLE 4

Transport Bag for 4 Gravity Vari-Poles®

Product number	GBGVARIPOLE4B
Product type	Stands and tripod accessories
Type	Transport bag
For number of stands	4
For type of stand	Clamping rod
Colour	Black
Material	Nylon 600D
Thickness of the padding	10 mm
Latch	Zip
Width	2150 mm
Height	430 mm
Depth	120 mm
Weight	3.5 kg
Black ring pack included	No





BG WBLs 331

Transport Bag for Square Base Plate

Product number	GBGWBLs331
Product type	Stands and tripod accessories
Type	Transport bag
Colour	Black
Material	Nylon 1680D
Thickness of the padding	5 mm
Latch	Double zip
Width	600 mm
Height	600 mm
Weight	0.591 kg



BG WB 123

Transport Bag for 450 mm Round Base Plate

Product number	GBGWb123
Product type	Stands and Tripod Accessories
Type	Transport bag
Colour	Black
Material	Nylon 1680D
Thickness of the padding	5 mm
Diameter	480 mm
Latch	Zip
Weight	0.37 kg



CARRY BAGS



BG KS 1 B

Transport Bag for Keyboard Stand

Product number	GBGKS1B
Product type	Stands and tripod accessories
Type	Transport bag
For number of stands	1
For type of stand	Keyboard stand
Colour	Black
Material	Neoprene
Thickness of the padding	1 mm
Latch	Double zip
Width	560 mm
Height	1070 mm
Depth	25 mm
Weight	0.55 kg
Black ring pack included	No



BG NS 1 B

Transport Bag for Music Stand

Product number	GBGNS1B
Product type	Stands and tripod accessories
Type	Transport bag
For number of stands	1
Colour	Black
Material	Nylon 600D
Latch	Zip
Width	820 mm
Height	400 mm
Depth	10 mm
Weight	1.1 kg





go play outside

MAUI® 5 GO
ULTRA-PORTABLE BATTERY-POWERED COLUMN PA SYSTEM



Combining **outstanding sound quality** and stunning **compact design** with the amazing versatility of **battery-operated** speakers, we've created an **ultra-portable PA system** for you: meet the **MAUI 5 GO**. Powered by a **high-capacity Li-Ion battery**, the **MAUI 5 GO** allows you to **play your music wherever you feel like**. And thanks to the optional, **quick-swappable battery packs**, you can also play for as long as you like. Now nothing can hold you back – **so GO play outside!**



DESIGNED & ENGINEERED
IN GERMANY

GO PLAY OUTSIDE AT:
LD-SYSTEMS.COM/MAUI5GO

NOTES

NOTES





PREMIUM STANDS CATALOGUE

DESIGNED & ENGINEERED
IN GERMANY.



gravitystands.com



EDITION 2019



The information contained in this publication, including numerical data, has been prepared as a general guide to the products, but intending buyers and users must satisfy themselves as to the suitability and the safety of the products for their particular purposes and duties. No responsibility is assumed for any errors herein. The company reserves the right to alter the designs and material specifications of products shown in this publication without notice.