



SUBHARMONICON

USER'S MANUAL



“To me, the synthesizer was always a source of new sounds that musicians could use to expand the range of possibilities for making music.”

- Dr. Robert Moog -

IMPORTANT SAFETY INSTRUCTIONS

WARNING - WHEN USING ELECTRIC PRODUCTS, THESE BASIC PRECAUTIONS SHOULD ALWAYS BE FOLLOWED:

1. Read all the instructions before using the product.
2. Do not use this product near water - for example, near a bathtub, washbowl, kitchen sink, in a wet basement, or near a swimming pool or the like.
3. This product, in combination with an amplifier and headphones or speakers, may be capable of producing sound levels that could cause permanent hearing loss. Do not operate for a long period of time at a high volume level or at a level that is uncomfortable.
4. The product should be located so that its location does not interfere with its proper ventilation.
5. The product should be located away from heat sources such as radiators, heat registers, or other products that produce heat. No naked flame sources (such as candles, lighters, etc.) should be placed near this product.
6. Do not operate in direct sunlight.
7. The product should be connected to a power supply only of the type described in the operating instructions or as marked on the product.
8. The power supply cord of the product should be unplugged from the outlet when left unused for a long period of time or during lightning storms.
9. Care should be taken so that objects do not fall, and liquids are not spilled, into the enclosure through openings.

There are no user serviceable parts inside. Refer all servicing to qualified personnel only.

NOTE: This equipment has been tested and found to comply with the limits for a Class B digital device, pursuant to Part 15 of the FCC rules. These limits are designed to provide reasonable protection against harmful interference in a residential installation. This equipment generates, uses, and can radiate radio frequency energy and, if not installed and used in accordance with the instructions, may cause harmful interference to radio communications. However, there is no guarantee that interference will not occur in a particular installation. If this equipment does cause harmful interference to radio or television reception, which can be determined by turning the equipment off and on, the user is encouraged to try to correct the interference by one or more of the following measures:

- Reorient or relocate the receiving antenna.
- Increase the separation between the equipment and receiver.
- Connect the equipment to an outlet on a circuit different from that to which the receiver is connected.
- Consult the dealer or an experienced radio/TV technician for help.

CAUTION: Please note that any changes or modifications made to this product not expressly approved by Moog Music, Inc. could void the user's authority granted by the FCC to operate the equipment.

TABLE OF CONTENTS

6	OVERVIEW
8	UNPACKING & INSPECTION
8	SETUP & CONNECTIONS
9	ABOUT SUBHARMONICON
10	INTRODUCTION
10	A BRIEF HISTORY
10	UNDERSTANDING SUBHARMONICS
11	UNDERSTANDING POLYRHYTHMS
12	EXPLORING YOUR SUBHARMONICON
13	CREATING A SEQUENCE
15	PLAYING YOUR SEQUENCE
17	UNDERSTANDING TUNING SYSTEMS AND TEMPERAMENT
18	PANEL CONTROLS & FUNCTIONS
18	THE OSCILLATORS
21	THE MIXER
23	THE FILTER
23	THE AMPLIFIER (VCA)
24	THE ENVELOPE GENERATORS (EG)
25	TEMPO
26	THE SEQUENCERS
28	TRANSPORT CONTROLS
30	POLYRHYTHM GENERATORS
31	THE PATCHBAY
38	USING SUBHARMONICON TO CLOCK DFAM
39	SYNCING SUBHARMONICON TO MOTHER-32
40	USING SUBHARMONICON AS A EURORACK MODULE
41	GLOBAL PARAMETERS
42	MIDI OPERATIONS
45	PRESETS
50	BLANK PRESETS
56	SIGNAL FLOW
58	SPECIFICATIONS
58	ACCESSORIES
59	WARRANTY
59	SERVICE & SUPPORT INFORMATION

RHYTHM GENERATORS PAGE 30

Dividing the tempo creates a new rhythm. Each of the four rhythm generators can drive one or both sequencers. Combine rhythms for exciting polyrhythms.

SEQUENCER PAGE 26

Sequencer 1 controls VCO 1 (and its subs). Sequencer 2 controls VCO 2 (and its subs). Each sequencer has four tunable steps.

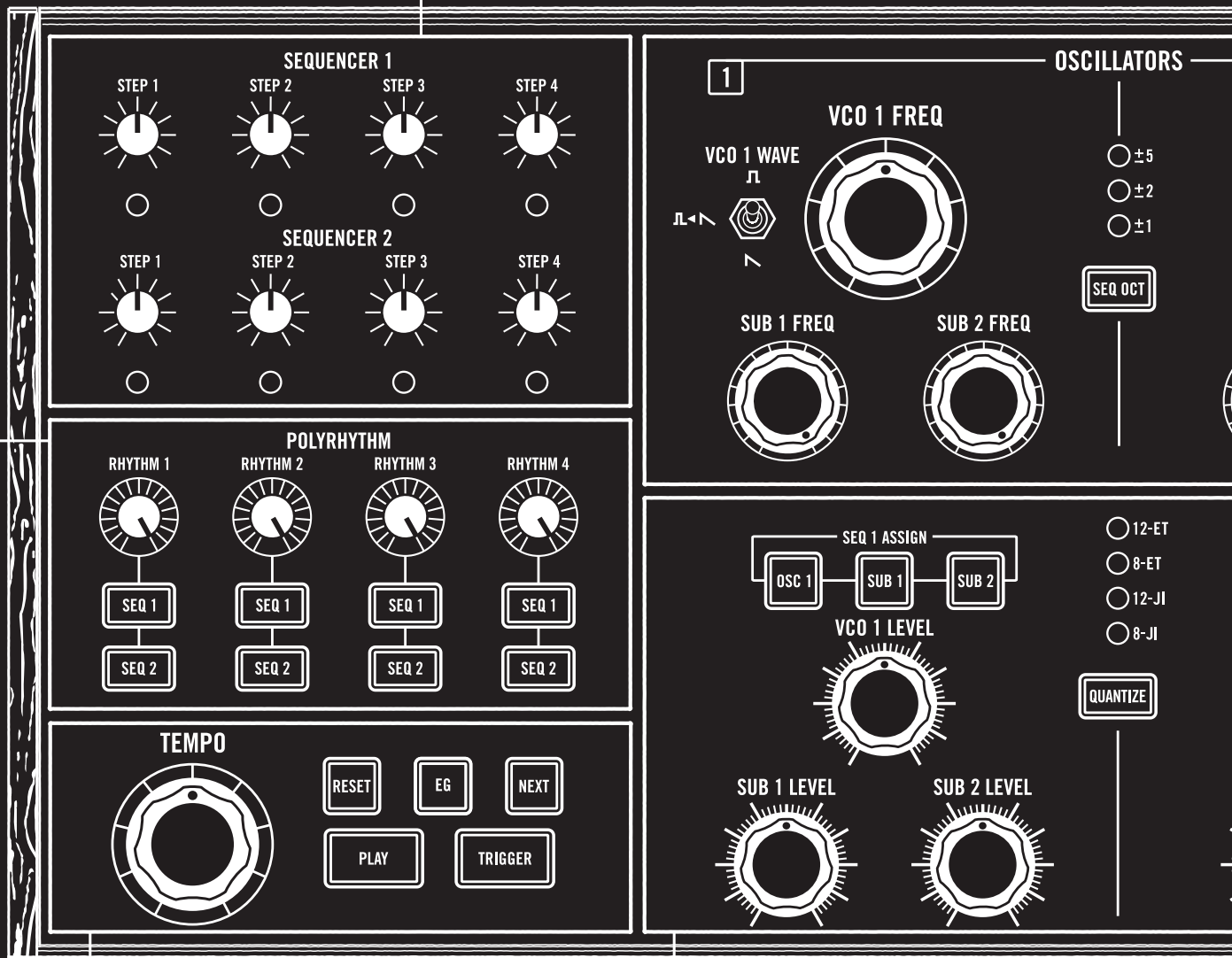

TEMPO & TRANSPORT PAGE 25 & 28

The tempo drives the rhythm generators, which in turn drive the sequencers. The transport controls start and stop the sequencers, advance to the next step, and more.

MIXER PAGE 21

The mixer allows the levels of all six Subharmonic sound sources (VCO 1, SUB 1, SUB 2 and VCO 2, SUB 1, SUB 2) to be set individually to create the perfect mix. The combined signal is sent from the mixer to the filter for further sound-shaping. (This section is also home to the quantize and sequencer assign functions.)

SUBHARMONICON

OSCILLATORS PAGE 18

Two analog oscillators (VCO 1, VCO 2) form the foundation of the sound. Change the waveform to select a new timbre. Each VCO can be continuously tuned over a specific range, or quantized to the steps in one of four scales. Two subharmonic oscillators per VCO are individually tunable to one of the first 16 undertones of the VCO's current pitch.

FILTERS PAGE 23

The famous Moog ladder filter provides excellent timbre control. This VCF operates as a low-pass, four-pole (-24dB/octave) filter. Resonance control is provided.

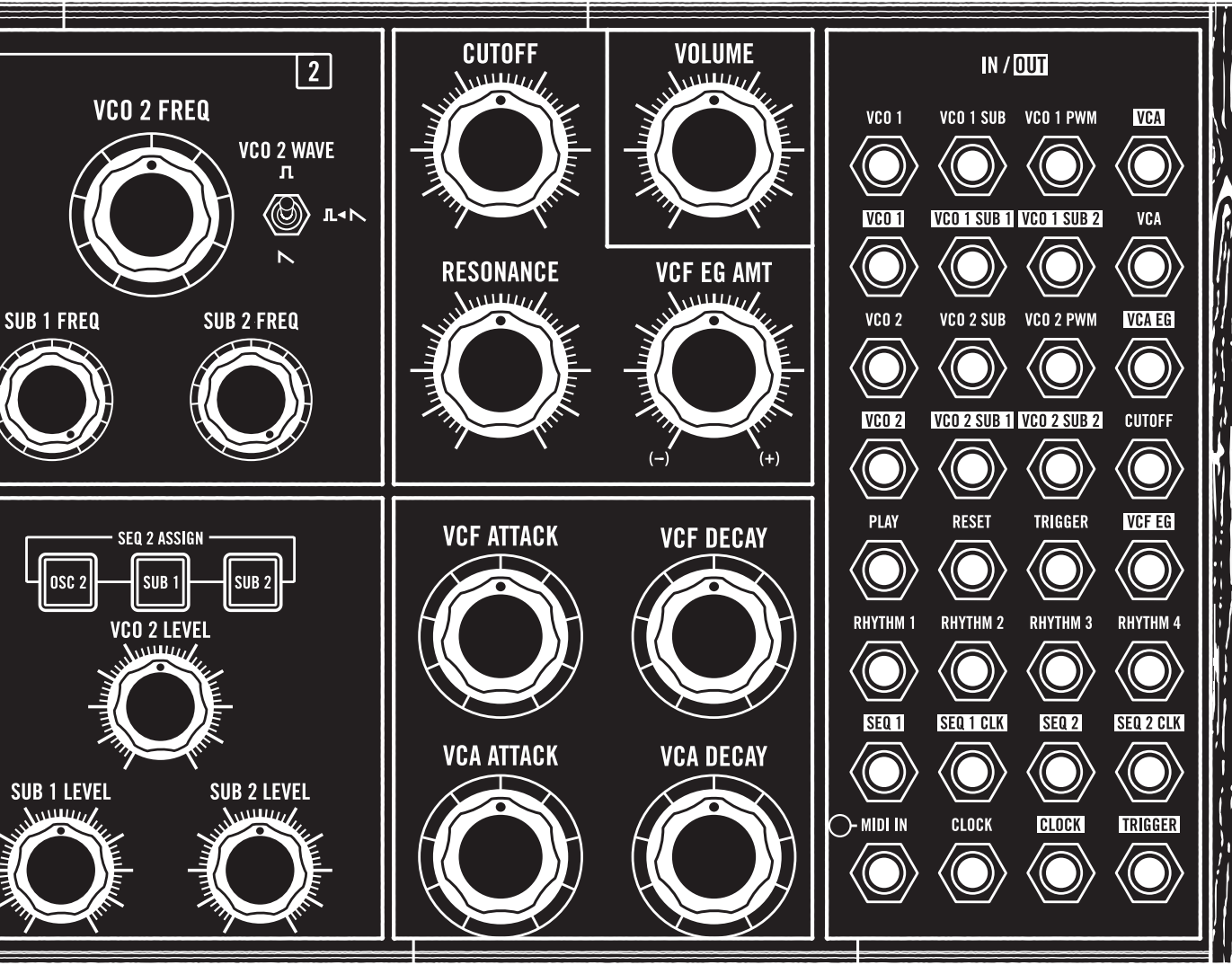

ENVELOPES PAGE 24

Two envelope generators define how the sound changes over time. The VCF EG controls the attack time and decay time of the filter (VCF); the VCA EG controls the volume (VCA).

PATCHBAY PAGE 31

This patchbay offers 32 connections (17 inputs and 15 outputs) for connecting to other modular or semi-modular synthesizers and audio equipment. MIDI data can be received at the MIDI IN jack using the included Type A MIDI adapter at the MIDI IN jack.

UNPACKING & INSPECTION

Check the contents of the shipping carton. Be careful when unpacking your new Moog Subharmonic so that nothing is lost or damaged. We recommend saving the carton and all packing materials in case you ever need to ship the instrument for any reason.

Subharmonic ships with the following items:

1. Subharmonic Semi-Modular Analog Polyrhythmic Synthesizer
2. Power Supply
3. DIN Socket to 3.5mm Plug (Type A) MIDI Adapter
4. Patch Sheet Overlays
5. Owner's Manual
6. Patch Cables
7. Registration Card

What you will need:

1. Headphones with a 1/4" TRS plug, or a 1/4" TS instrument cable and an amplified speaker
2. A properly wired AC outlet

SETUP & CONNECTIONS



POWER

Plug the included power adapter into the **12VDC** power jack on the rear panel of your Subharmonic.

NOTE: There is no power switch on your Subharmonic. Once connected to the power supply, the unit is On. Subharmonic is an analog instrument and should be allowed a few minutes to warm up before use. In cases where it has been left in a cold car overnight, for example, it may take even longer for the oscillator tuning to stabilize. For optimized tuning do not operate your Subharmonic in direct sunlight.

AUDIO OUT / 1/4"

With the Subharmonic **VOLUME** knob turned all the way down (counterclockwise), plug one end of a 1/4" instrument cable into the Subharmonic **AUDIO OUT / 1/4"** jack on the rear panel. Then plug the other end into an amplified speaker or mixing console input. This jack can also be used with a set of mono or stereo headphones, providing the same signal to each ear. Now, raise the **VOLUME** knob (clockwise) to bring the sound to an appropriate level.

WARNING: Do not use a TRS (balanced) cable for line output applications, as this will cause phase cancellation and can produce a very weak signal.

KENSINGTON SECURITY SLOT

Your Subharmonic can be securely attached to a desk, stand, or other fixture by connecting a Kensington security device to this slot.

ABOUT SUBHARMONICON

Subharmonic is an intensely creative semi-modular analog polyrhythmic synthesizer that uses mathematical ratios to tune its four subharmonic oscillators, and to control the timing of its four rhythm generators. Because these tuning and timing values are integer-derived, there is something uniquely coherent about how patterns and phrases created using Subharmonic blend together musically. As with Mother-32 and DFAM, Subharmonic conforms to the 60HP Eurorack format; features aluminum rails, finished wood side pieces, an extensive patchbay; and can perform as a standalone electronic instrument.

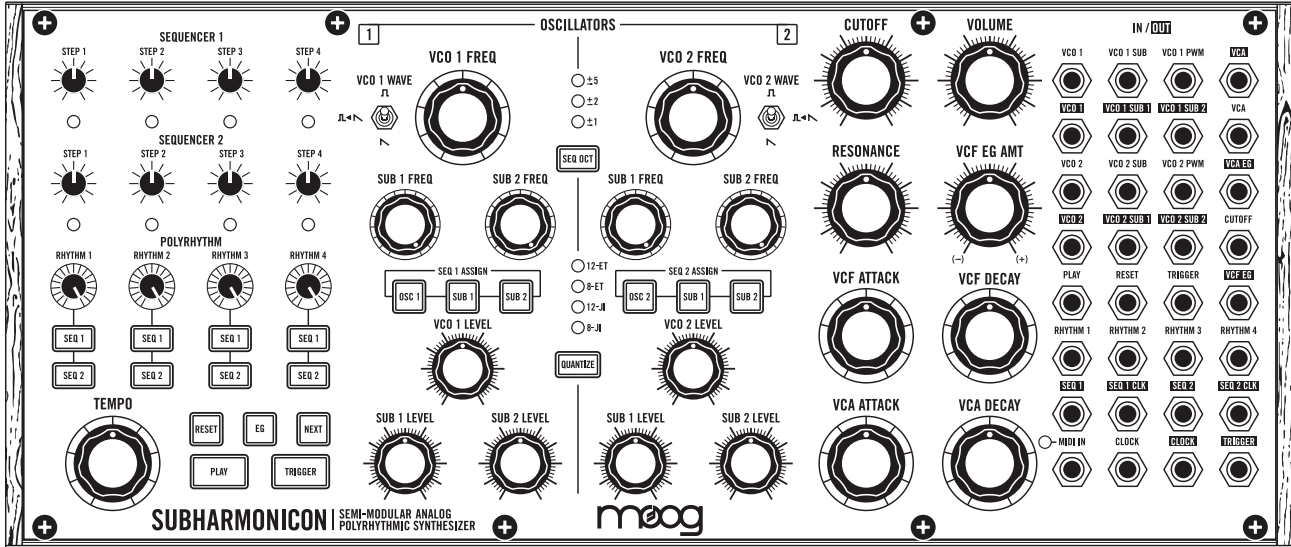

2 VOLTAGE CONTROLLED OSCILLATORS (VCOs)

Each VCO features two additional subharmonic oscillators

POLYRHYTHM SECTION: 4 RHYTHM GENERATORS

Each rhythm generator can be set to drive a single sequencer – or both

TWO 4-STEP SEQUENCERS

Each sequencer controls any combination of its associated VCO, SUB 1, and SUB 2

2 ENVELOPE GENERATORS

Two Attack/Decay envelope generators control the VCF and VCA

RESONANT MOOG FILTER

4-pole (-24 db/octave) low-pass Moog ladder filter

PATCHING

32-point modular patchbay offering 17 inputs and 15 outputs

INTRODUCTION

■ A BRIEF HISTORY

Throughout the 1960s and 70s, groundbreaking artists like Herb Deutsch, Wendy Carlos, and Keith Emerson were looking for new ways to explore electronic sound, and found themselves collaborating with electronic instrument pioneer Bob Moog to create the instruments of their dreams. If we set our clocks back to the 1930s, we find a similar situation. Cutting-edge musicians and composers such as Henry Cowell, Joseph Schillinger, Paul Hindemith, and Oskar Sala were teaming up with the likes of Leon Theremin (of Theremin fame) and Freidrich Trautwein to create the instruments needed to bring their musical visions to life. These were heady times for composers, performers, and instrument creators. Electricity and electrical circuitry held the promise of a mechanical prowess that could enhance and extend existing compositional and performance abilities.

Freidrich Trautwein's Trautonium was a vacuum tube electronic instrument that created a rich sawtooth wave, tamed by a resonant low-pass filter, to create an early model of subtractive synthesis. Oskar Sala eventually took over development of the Trautonium (later renamed the Mixtur-Trautonium), adding a series of subharmonic oscillators that generated undertones pitched at fractions of the original pitch (and not the overtones created at multiples of the original pitch, such as in Laurens Hammond's tone-wheel organ). Around the same time, Henry Cowell and Joseph Schillinger collaborated with Leon Theremin on the Rhythmicon, an instrument capable of sounding up to 16 polyrhythm generators simultaneously. Schillinger's theories included combining rhythmic "generators" occurring at integer-related durations.

Their work contained the seeds of today's algorithmic composition software. The subharmonic oscillators of the Mixtur-Trautonium were derived from the oscillator's initial pitch, while the Rhythmicon created polyrhythms that were derived from the original tempo. It is these concepts of subharmonics and polyrhythms that form the historic roots of your Moog Subharmonicon, an inspiring and innovative semi-modular analog polyrhythmic synthesizer.

■ UNDERSTANDING SUBHARMONICS

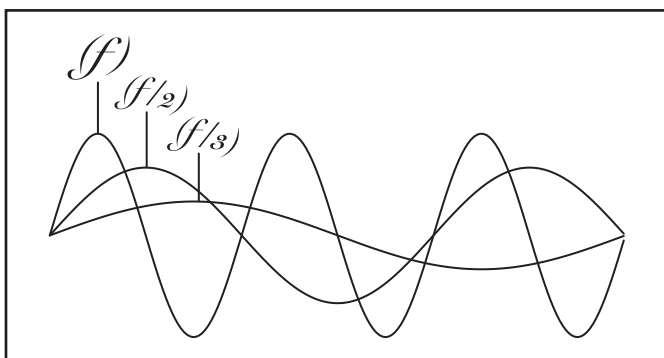

In the world of synthesizers and electronic keyboards, we often refer to harmonics – a series of overtones occurring at fixed mathematical intervals above the fundamental pitch that are responsible for a wave's shape and timbre. A wave shape may contain certain harmonics in a particular pattern of relative strength, for example. We know that pitch can be modified by changing the length of an organ pipe, a guitar string, the column of air in a trumpet, etc. The remarkable

thing is that the ratio between the original pitch and the altered pitch always follows the same pattern – the harmonic series. So if we have a guitar string vibrating at a frequency (f) of 440 Hz, and we halve its length by playing at the 12th fret, the string sounds one octave higher ($f*2$) at 880 Hz, or double the original frequency. One-third the length produces the fifth above that ($f*3$), etc. In every case, multiplying the original frequency by an integer creates a specific harmonic.

Creating an undertone, or a subharmonic, is more challenging in the physical world. Instead of multiplying the original frequency by an integer value, we must divide by an integer value. We cannot simply build a guitar that becomes twice as large in order to play the first subharmonic, one octave down in pitch at 220 Hz ($f/2$) from the original pitch (f) of 440 Hz.

UNDERSTANDING SUBHARMONICS *(Continued)*

Fortunately, electronic circuits can create subharmonics quite easily. Regardless of whether the initial frequency (f) is being multiplied by an integer to create an overtone, or divided by an integer to create a subharmonic undertone, the ratios and intervals will remain the same, as in the following examples:

Overtones	
Original Note	(f)
2 nd Harmonic	$(f) * 2$
3 rd Harmonic	$(f) * 3$
4 th Harmonic	$(f) * 4$
5 th Harmonic	$(f) * 5$
6 th Harmonic	$(f) * 6$
...	Continued
15 th Harmonic	$(f) * 15$
16 th Harmonic	$(f) * 16$

Undertones	
Original Note	(f)
2 nd Subharmonic	$(f) / 2$
3 rd Subharmonic	$(f) / 3$
4 th Subharmonic	$(f) / 4$
5 th Subharmonic	$(f) / 5$
6 th Subharmonic	$(f) / 6$
...	Continued
15 th Subharmonic	$(f) / 15$
16 th Subharmonic	$(f) / 16$

■ UNDERSTANDING POLYRHYTHMS

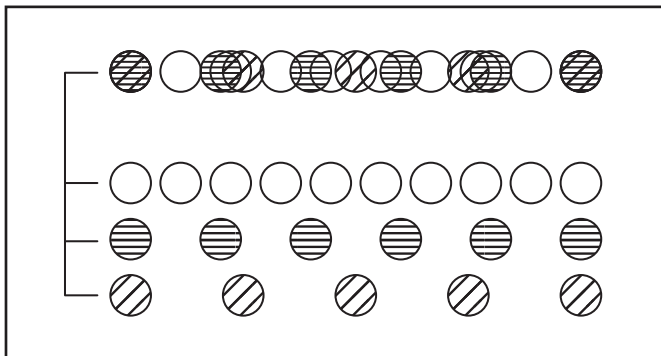

Polyrhythms employ multiple rhythms playing at once to create complex, interweaving phrases. In the same way that a subharmonic oscillator uses an integer value to modify the initial pitch (f) of an oscillator to create a musically related subharmonic, each Subharmonicon rhythm generator uses an integer value to divide the current clock value (t) to create a new rhythm. These individual rhythm generators are used to drive one or both of the

Subharmonicon's sequencers. Once you engage more than one rhythm generator, you will hear how the different clock divisions can play off or against one another to synthesize a polyrhythm. Because each rhythm generator references the same clock, they will eventually re-sync to the same downbeat, causing the overarching polyrhythm to finally repeat. In this way, you can think of the rhythm generators as combining to create one larger, cyclic pattern. Rhythm generators can be switched on and off and assigned to different sequencers as you perform, creating complex polyrhythmic content – as well as some truly unique phrasing and grooves.

EXPLORING YOUR SUBHARMONICON

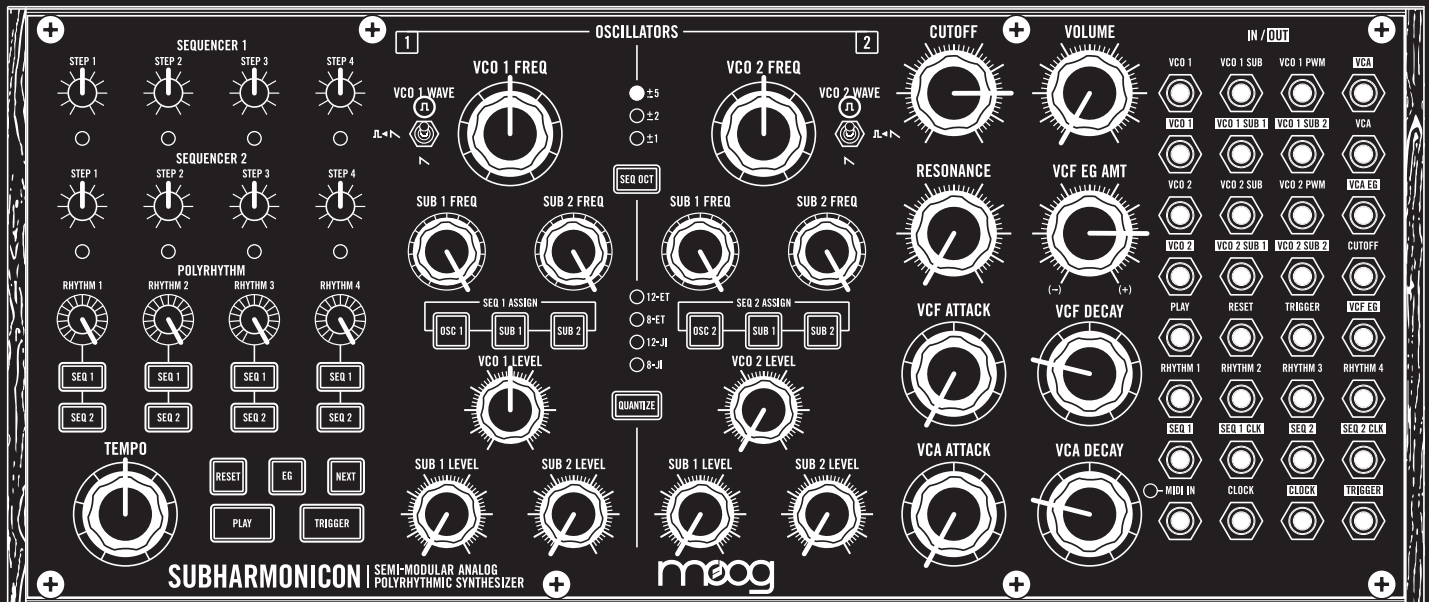

If you are new to synthesizers, or if you just want a deeper understanding of your new instrument before you get started, join us for a quick hands-on Subharmonic tour. Knowing what to expect as you explore the controls will make it easier to achieve your musical goals. You can also begin by following some of the patch examples (beginning on page 45) and tweaking them to suit your own taste.

■ START YOUR EXPLORATION

To begin, connect Subharmonic to either a set of headphones or a monitoring system, and set the controls on your Subharmonic to match the settings shown above.

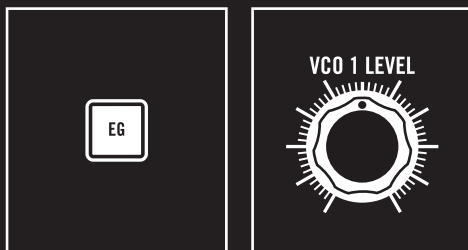

LISTENING TO VCO 1

Hold the **EG** button until it begins to blink. This locks the VCF EG and VCA EG at their highest values, allowing you to hear what is happening as you experiment. Raise the **VCO 1 LEVEL** knob to the halfway (or center) point, and then raise the **VOLUME** knob to a comfortable listening level. You are now hearing VCO 1.



TUNING VCO 1

Press the **QUANTIZE** button until no lights are lit (unquantized), and rotate the **VCO 1 FREQ** knob to listen to the tuning range of VCO 1, and you will hear the pitch change smoothly over a wide range. Next, press the **QUANTIZE** button until the **12-ET** LED indicator is lit. Now, as you rotate the **VCO 1 FREQ** knob, you will hear the frequency step from note to note, following the steps of a 12-tone equal tempered scale.

EXPLORING YOUR SUBHARMONICON *(Continued)*

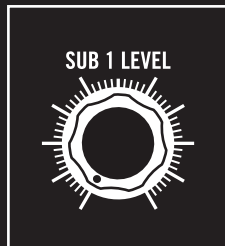

ADDING IN A SUBHARMONIC OSCILLATOR

Rotate the **SUB 1 LEVEL** knob clockwise and you will hear the sound of the first subharmonic oscillator associated with VCO 1 mixed in with the sound of VCO 1. With the **SUB 1 FREQ** knob all the way clockwise, VCO 1 and SUB 1 are playing in unison. As you rotate the **SUB 1 FREQ** knob slowly counter-clockwise, you will hear the pitch of SUB 1 step through the available undertones.

■ CREATING A SEQUENCE

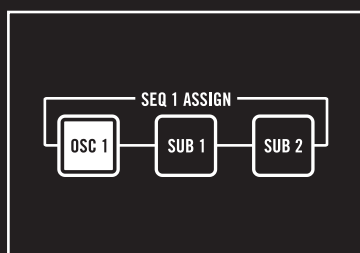

INTRODUCTION

Before we can create a sequence, we need to let Subharmonic know what our intentions are. First, press the **OSC 1** button (located in the **SEQ 1 ASSIGN** buttons) so that it is lit. This allows the individual **STEP** knobs of Sequencer 1 to modify the pitch of VCO 1.

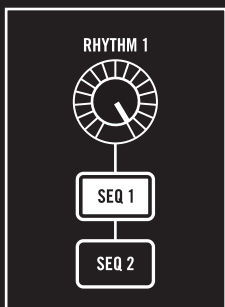

Next, press the **SEQ 1** button (located under the **RHYTHM 1** knob) so that it is lit. This step attaches a rhythm source to Sequencer 1, so that we can use the **NEXT** and **RESET** buttons to navigate the individual steps of Sequencer 1.



Finally, use the **SEQ OCT** button to select the range, in octaves, of the sequencer **STEP** knobs. An LED will indicate the current selection. Use the **SEQ OCT** button to cycle through the available options. For now, let's use the ± 2 option.

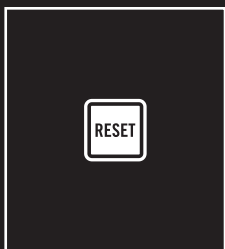

Press the **RESET** button to return the sequencer(s) to Step 1. This will also reset the rhythm generators to their starting position.

EXPLORING YOUR SUBHARMONICON *(Continued)*

CREATING A SEQUENCE *(Continued)*

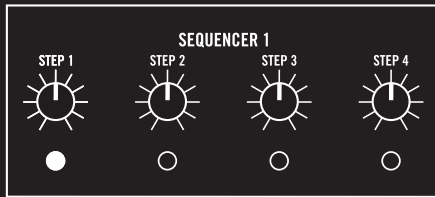

TUNING STEP 1

Step 1 is now selected, and the LED indicator located under the **STEP 1** knob will be lit. As you listen, rotate the **STEP 1** knob to set a pitch for Step 1 of your sequence.

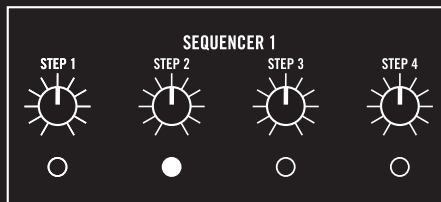
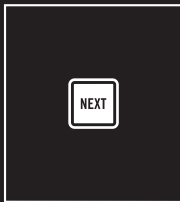

ADVANCING TO STEP 2

Press the **NEXT** button to advance to Step 2 of the sequence. The LED indicator located under the **STEP 2** knob will be lit. As you listen, rotate the **STEP 2** knob to set a pitch for Step 2 of your sequence.

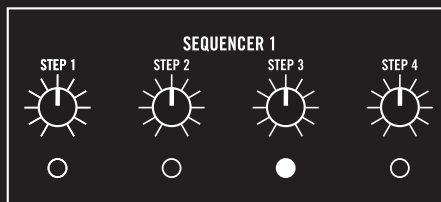

ADVANCING TO STEP 3

Press the **NEXT** button to advance to Step 3 of the sequence. The LED indicator located under the **STEP 3** knob will be lit. As you listen, rotate the **STEP 3** knob to set a pitch for Step 3 of your sequence.

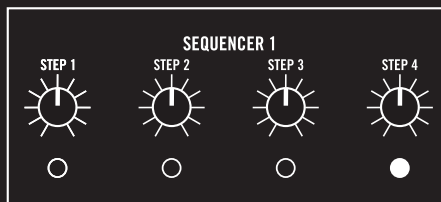
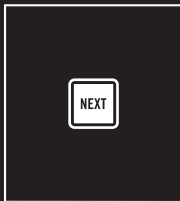

ADVANCING TO STEP 4

Press the **NEXT** button to advance to Step 4 of the sequence. The LED indicator located under the **STEP 4** knob will be lit. As you listen, rotate the **STEP 4** knob to set a pitch for Step 4 of your sequence.

NOTE: You can use the **NEXT** button to continually cycle through the steps, so you can change the **STEP** knob values until you have a pattern you like.

EXPLORING YOUR SUBHARMONICON *(Continued)*

■ PLAYING YOUR SEQUENCE

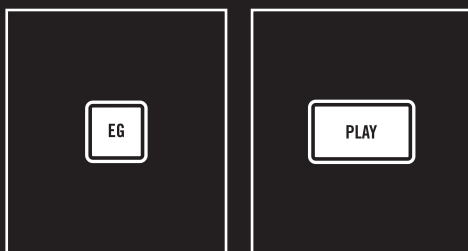

Press the blinking **EG** button so that it remains lit. This releases the envelope generators from their held state, so that each step of the sequencer will now trigger the EGs.

Now, press the **PLAY** button. Your sequence will begin to play.

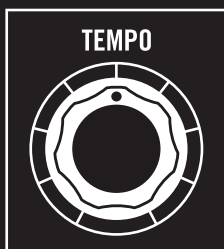

ADJUSTING THE TIMING

Rotate the **TEMPO** knob to see how the sequencer and rhythm generator tempos are affected.

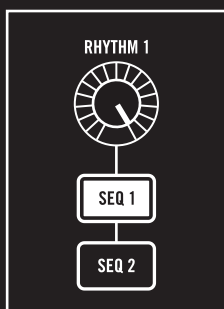

Rhythm Generator 1 is currently producing a division of the master tempo to drive Sequencer 1, indicated by the illuminated **SEQ 1** button. Notice that as you turn the **RHYTHM 1** knob, you are selecting one of 16 discrete steps. These steps are produced by dividing the tempo by an integer value of 1 through 16.

***NOTE:** This is the same method (dividing by an integer value of 1 through 16) that is used for deriving the pitch of a subharmonic oscillator.*

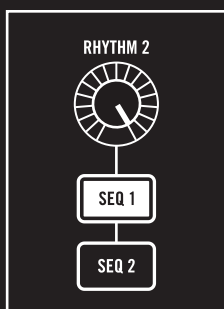

CREATING A POLYRHYTHM

As your sequence continues to play, press the **SEQ 1** button associated with Rhythm Generator 2. You are now using the output of two rhythm generators to drive Sequencer 1, creating a polyrhythm. As you rotate the **RHYTHM 2** knob further from and closer to the **RHYTHM 1** knob position, you can hear how the complexity of this polyrhythm changes.

***TIP:** As you are trying new polyrhythm settings, you can use the **RESET** button to instantly set the sequencer(s) and the rhythm generators to their initial starting position, inviting you to explore how the polyrhythm unfolds and cycles back.*

EXPLORING YOUR SUBHARMONICON *(Continued)*

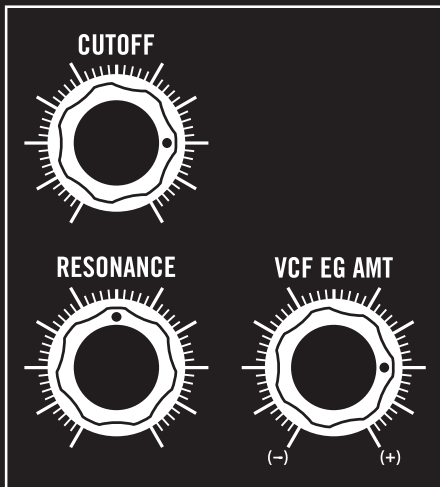

EXPLORING THE FILTER

As your sequence continues to play, you can rotate the **CUTOFF** and **RESONANCE** knobs and listen to how changing the filter settings can affect the timbre of your sequenced sound. The **VCF EG AMT** knob defines how much effect the VCF Envelope Generator (VCF EG) will have on the filter settings. By turning the **RESONANCE** knob toward maximum and experimenting with the **CUTOFF** knob, you can coax the filter to “chirp” as it approaches a self-resonant state. Try it!



CHANGING THE WAVE

As you explore the ways different filter settings affect the timbre of each note, you can also use the **VCO 1 WAVE** switch to hear how different waves affect the overall sound.

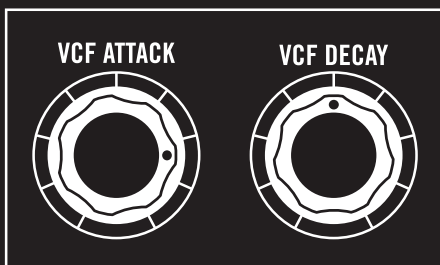

TWEAKING THE ENVELOPES

As your sequence continues to play, you can change the Attack and Decay rates for both the VCF EG and the VCA EG. The VCF EG changes the Cutoff Frequency of the Voltage Controlled Filter (VCF) over time; the VCA EG changes the Voltage Controlled Amplifier (VCA) setting, or output volume, over time. Using relatively quick attack and decay rates can be best for percussive effects and punchy basses or leads. Slower decay times can add more of a drone or atmospheric feel to the sound.

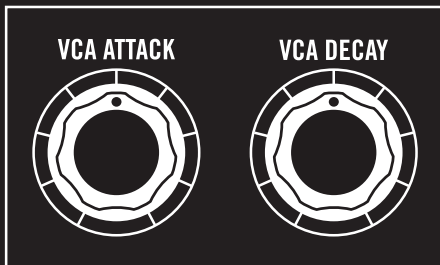

And don't forget, the **VCF EG AMT** knob is bi-directional, with the center position creating no effect. Rotating the **VCF EG AMT** clockwise adds a positive amount of envelope control, while rotating this knob counter-clockwise adds a negative amount of envelope control, creating some very useful and unusual effects.

EXPLORING YOUR SUBHARMONICON *(Continued)*

■ SUMMARY

In this exploration of your Subharmonic, we have used only one VCO, one subharmonic oscillator, one sequencer, and two rhythm generators — working with each to become familiar with how they contribute to your overall sound.

This is only scratching at the surface of the sound design potential and rhythmic phrases that are possible within this instrument once all of its oscillators, sequencers, and rhythm generators are dialed up. We hope that this exercise provides you with a foundation from which you can continue your experimentations.

Keep in mind that Subharmonic is a performance instrument. Changing the rhythm generator assignment in real time, using the **RESET** button, pushing the **SEQ ASSIGN** buttons, and tweaking the filter controls and mix levels can result in an engaging and fluid electronic music event.

■ UNDERSTANDING TUNING SYSTEMS & TEMPERAMENT



When talking about musical instruments, tuning systems are the method used to determine which frequencies or pitches an instrument is able to play. Subharmonic's sequencer section is unique in its ability to easily work within two different tuning systems: just intonation (JI) and equal temperament (ET).

Just intonation is an older approach to generating musical scales based around whole number ratios (i.e. the harmonic series). So, if we wanted to work in the "just scale" of C major, we'd be determining our note values based on whole number fractions related to C's frequency (e.g. C=1/1, D=9/8, E=5/4, F=4/3, G = 3/2, A=5/3, B=15/8, C=2/1, etc.). Working in just intonation becomes

complicated when you want to play music in more than one key. Because a just scale's note values are based around a root note's frequency, the moment you try and modulate to a different key, all of your notes will sound incorrect since they were derived from the original root note; this is when the idea of a temperament becomes important. A temperament is a tuning system that compromises the pure intervals of just intonation in order to achieve better harmonic relationships between differing keys. The most commonly used temperament is equal temperament.

Equal temperament is based around the idea of dividing an octave into 12 evenly spaced semitones, so that scale intervals will be the same in any key. This creates scales in which all intervals are imperfect (when compared to just intonation) but still tolerable to the ear, and by making all the note values equally 'incorrect' you can easily write music that jumps between keys without needing to retune your instrument. Equal temperament has been the standard tuning system in western music since the 18th century, and is what most people will consider as sounding "in tune," despite the fact that just intonation is technically more in tune due to its basis in the harmonic series.

As a listening exercise, try building up a complex chord using the **VCO FREQ** and **SUB FREQ** knobs, and use the **QUANTIZE** button to listen to how your chord voicing changes with the different quantization settings. One aspect that should be especially noticeable in just intonation, is the lack of frequency beating typically heard in minor chords.

PANEL CONTROLS & FUNCTIONS

THE OSCILLATORS

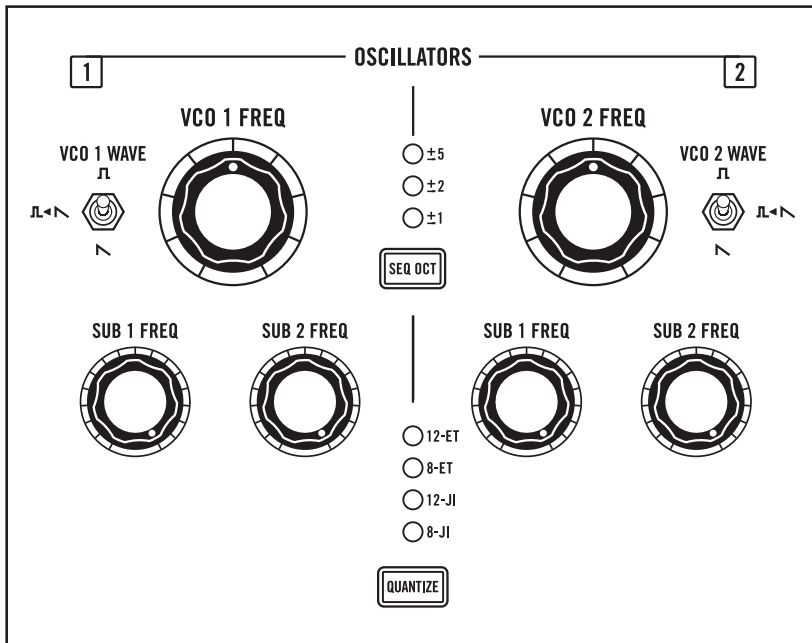

In the synthesizer world, the primary role of an oscillator is to generate sound. Oscillators can be assigned a wave shape to determine the initial timbre of the sound, oscillators can be tuned to specific frequencies, and an oscillator can be played — its pitch varied by a control voltage source such as a keyboard or sequencer.

Each voltage controlled oscillator (VCO 1 and VCO 2) is equipped with two subharmonic oscillators.

These subharmonic oscillators can be independently set to a specific note, or subharmonic, of the undertone series.

OSCILLATOR 1 PARAMETERS



VCO 1 FREQ

Rotating this knob will set the initial frequency, or pitch, of VCO 1. The range of this knob is four octaves. Rotating the **VCO 1 FREQ** knob fully counter-clockwise will specify the initial pitch as Middle C (262 Hz) on a piano. Rotating this knob fully clockwise will specify the initial pitch as the highest C (4186 Hz) on a piano.

NOTE: Engaging the **QUANTIZE** settings will limit the available values for the **VCO 1 FREQ** knob to the specific scale steps set by the current value of the **QUANTIZE** button.

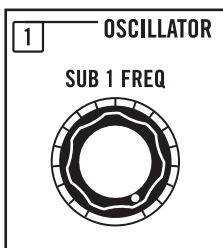

SUB 1 FREQ (VCO 1)

The pitch or frequency of SUB 1 (the first subharmonic oscillator of VCO 1) is derived from the initial frequency (f) of VCO 1. The SUB 1 frequency is equal to the initial pitch of VCO 1, divided by a whole number integer value from 1 to 16. As you rotate the **SUB 1 FREQ** knob, you are actually selecting the integer value used. You can hear the pitch of SUB 1 change in stepped values, starting with 1 [unison tuning to VCO 1: $(f)/1 = (f)$] when this knob is rotated fully clockwise, and proceeding in steps to a value of 16 as this knob is rotated counter-clockwise. Each one of these values produces a note on the undertone scale derived from the initial pitch of VCO 1.

THE OSCILLATORS *(Continued)*

OSCILLATOR 1 PARAMETERS *(Continued)*

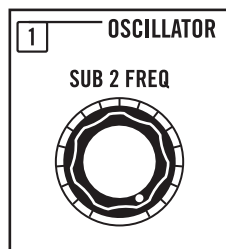

SUB 2 FREQ (VCO 1)

The pitch or frequency of SUB 2 (the second subharmonic oscillator of VCO 1) is derived from the initial frequency (f) of VCO 1. The SUB 2 frequency is equal to the initial pitch of VCO 1, divided by a whole number integer value from 1 to 16. As you rotate the **SUB 2 FREQ** knob, you are actually selecting the integer value used. You can hear the pitch of SUB 2 change in stepped values, starting with 1 [unison tuning to VCO 1: $(f)/1 = (f)$] when this knob is rotated fully clockwise; and proceeding in steps to a value of 16 as this knob is rotated counter-clockwise. Each one of these values produces a note on the undertone scale derived from the initial pitch of VCO 1.

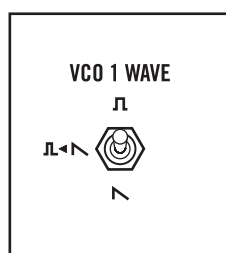

WAVEFORM (VCO 1)

The waveform being output by VCO 1, SUB 1, and SUB 2 is determined by this three-position switch.

UP: In this highest position, a square wave is output from VCO 1, SUB 1, and SUB 2. Square waves produce a hollow sound, providing a rich starting point for nasal clarinet and bass sounds.

MIDDLE: The middle position is a special case. With the switch in this position, SUB 1 and SUB 2 will both output sawtooth waves. However, VCO 1 will output a square (pulse) wave. By default, the sawtooth output of SUB 1 is normalled for use as a PWM (Pulse Width Modulation) source for the square wave of VCO 1. PWM can change the width of the pulse wave, altering its timbre which is popular for creating string-type sounds.

DOWN: In this lowest position, a sawtooth wave is output from each. In addition to creating thick, brassy sounds, the sawtooth wave also lends itself to powerful lead and bass sounds.

TIP: In the middle position, the PWM of VCO 1, caused by the audio-rate frequency of SUB 1, can appear to add a second pitched component to VCO 1, even when the **SUB 1 LEVEL** knob is at its minimum position.

NOTE: The normalled connection described above can be overridden by connecting a control signal to the **VCO 1 PWM** input jack of the patchbay.

OSCILLATOR 2 PARAMETERS

The Oscillator 2 parameters function in the same way as the Oscillator 1 parameters.



VCO 2 FREQ

Rotating this knob will set the initial frequency, or pitch, of VCO 2. The range of this knob is four octaves. Rotating the **VCO 2 FREQ** knob fully counter-clockwise will specify the initial pitch as Middle C (262 Hz) on a piano. Rotating this knob fully clockwise will specify the initial pitch as the highest C (4186 Hz) on a piano.

NOTE: Engaging the **QUANTIZE** settings will limit the available values for the **VCO 2 FREQ** knob from continuous to the specific scale steps set by the current value of the **QUANTIZE** button.

THE OSCILLATORS *(Continued)*

OSCILLATOR 2 PARAMETERS *(Continued)*

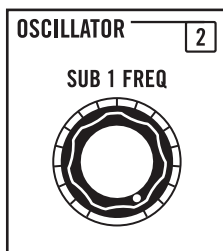

SUB 1 FREQ (VCO 2)

The pitch, or frequency of SUB 1 (the first Subharmonic Oscillator of VCO 2) is derived from the initial frequency (f) of VCO 2. The SUB 1 frequency is equal to the initial pitch of VCO 2, divided by a whole number integer value from 1 to 16. As you rotate the **SUB 1 FREQ** knob, you are actually selecting the integer value used. You can hear the pitch of SUB 1 change in stepped values, starting with 1 [unison tuning to VCO 2: $(f)/1 = (f)$] when this knob is rotated fully clockwise, and proceeding in steps to a value of 16 as this knob is rotated counter-clockwise. Each one of these values produces a note on the undertone scale derived from the initial pitch of VCO 2.

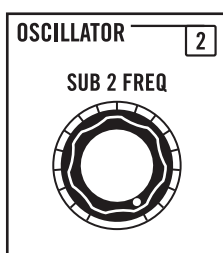

SUB 2 FREQ (VCO 2)

The pitch, or frequency of SUB 2 (the second Subharmonic Oscillator of VCO 2) is derived from the initial frequency (f) of VCO 2. The SUB 2 frequency is equal to the initial pitch of VCO 2, divided by a whole number integer value from 1 to 16. As you rotate the **SUB 2 FREQ** knob, you are actually selecting the integer value used. You can hear the pitch of SUB 2 change in stepped values, starting with 1 [unison tuning to VCO 2: $(f)/1 = (f)$] when this knob is rotated fully clockwise, and proceeding in steps to a value of 16 as this knob is rotated counter-clockwise. Each one of these values produces a note on the undertone scale derived from the initial pitch of VCO 2.

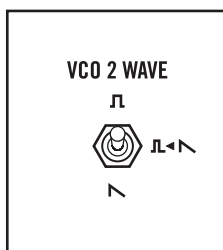

WAVEFORM (VCO 2)

The waveform being output by VCO 2, SUB 1, and SUB 2 is determined by this three-position switch.

UP: In this highest position, a square wave is output from VCO 2, SUB 1, and SUB 2. Square waves produce a hollow sound, providing a rich starting point for nasal clarinet and bass sounds.

MIDDLE: The middle position is a special case. With the switch in this position, SUB 1 and SUB 2 will both output sawtooth waves. However, VCO 2 will output a square (pulse) wave. By default, the sawtooth output of SUB 1 is normalled for use as a PWM (Pulse Width Modulation) source for the square wave of VCO 2. PWM can change the width of the pulse wave, altering its timbre which is popular for creating string-type sounds.

DOWN: In this lowest position, a sawtooth wave is output from each. In addition to creating thick, brassy sounds, the sawtooth wave also lends itself to powerful lead and bass sounds.

TIP: In the middle position, the PWM of VCO 2 caused by the audio-rate frequency of SUB 1 can appear to add a second pitched component to VCO 2, even when the **SUB 1 LEVEL** knob is at its minimum position.

NOTE: The normalled connection described above can be overridden by connecting a control signal to the **VCO 2 PWM** input jack of the patchbay.

THE OSCILLATORS *(Continued)*

SHARED OSCILLATOR PARAMETERS

Quantizing focuses the continuous sweep of an oscillator into stepped voltages that, in the case of Subharmonic, generate either a 12-tone or 8-tone division of the octave (with just or equal temperaments). Learn more about tuning systems and temperament on page 17. When the Quantize function is engaged, rotating the **VCO 1 FREQ** knob or the **VCO 2 FREQ** knob will select steps of the scale, as defined by the current Quantize setting. The Quantize function is shared by both oscillators; it cannot be set individually.

NOTE: By default, the **SEQ 1** and **SEQ 2** output jacks will output a control voltage that reflects the current Quantize settings. This behavior can be disengaged by pressing and holding the **QUANTIZE** button until the LED flashes, at which point the Oscillators will continue to respect the current Quantize settings, while the **SEQ 1** and **SEQ 2** output jacks will remain unquantized at the patchbay.

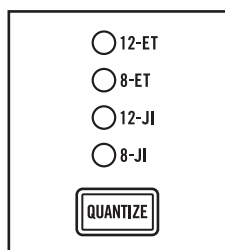

QUANTIZE

There are four quantized settings. Pressing the **QUANTIZE** button will cycle through the available settings, with an LED indicating the current selection. With all LEDs off, no Quantization value is selected, and the Quantize function is off.

12-ET: This option selects a Chromatic (12-step) scale using Equal Temperament (ET), which is the basis for Western keyboard music.

8-ET: This option selects a Diatonic (8-step) scale using Equal Temperament (ET).

12-JI: This quantize option uses a Chromatic (12-step) scale using Just Intonation (JI).

8-JI: This quantize option uses a Diatonic (8-step) scale using Just Intonation (JI).

THE MIXER

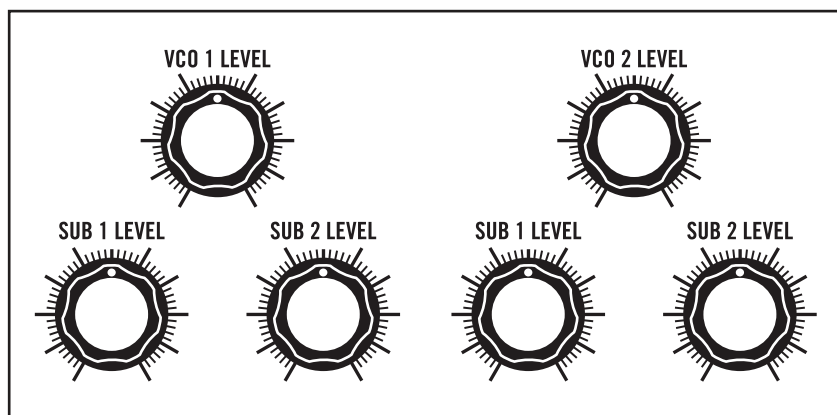

The mixer sets the individual levels of all six Subharmonic sound sources. The combined signal exits the mixer and enters the filter section.

NOTE: The mixer can be pushed into a warm distortion by setting the sound sources near their maximum levels. Setting the mixer to moderate levels will produce a cleaner sound.

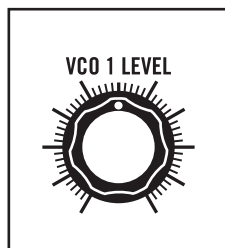

VCO 1 LEVEL

This knob sets the level of the VCO 1 signal. Rotating this knob clockwise will raise the level; rotating this knob counter-clockwise will lower the level.

THE MIXER *(Continued)*

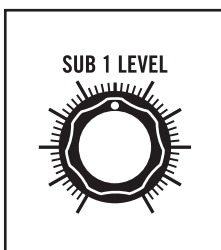

SUB 1 LEVEL (VCO 1)

This knob sets the level of SUB 1 — the first subharmonic oscillator associated with VCO 1. Rotating the knob clockwise raises the level; rotating it counter-clockwise lowers the level.

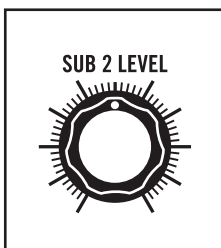

SUB 2 LEVEL (VCO 1)

This knob sets the level of SUB 2 — the second subharmonic oscillator associated with VCO 1. Rotating the knob clockwise raises the level; rotating it counter-clockwise lowers the level.

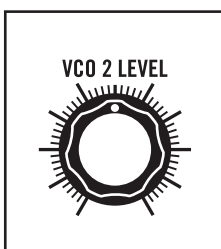

VCO 2 LEVEL

This knob sets the level of the VCO 2 signal. Rotating this knob clockwise will raise the level; rotating this knob counter-clockwise will lower the level.

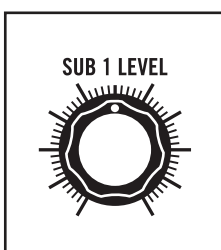

SUB 1 LEVEL (VCO 2)

This knob sets the level of SUB 1 — the first subharmonic oscillator associated with VCO 2. Rotating the knob clockwise raises the level; rotating it counter-clockwise lowers the level.

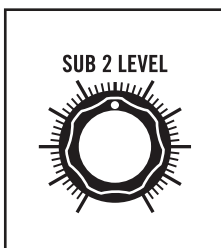

SUB 2 LEVEL (VCO 2)

This knob sets the level of SUB 2 — the second subharmonic oscillator associated with VCO 2. Rotating the knob clockwise raises the level; rotating it counter-clockwise lowers the level.

■ THE FILTER

The combined output signal from the mixer is internally wired to the input of the filter. Subharmonicon relies on a Voltage Controlled Filter (VCF) to dynamically shape the timbre of a sound by selectively removing frequencies above the Filter's Cutoff Frequency. This low-pass filter is of the famous Moog ladder type.

NOTE: Technically, this is a four-pole low-pass ladder filter providing 24 dB of attenuation per octave above the Cutoff Frequency.

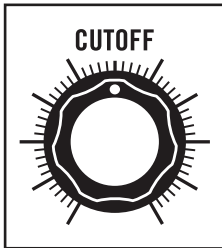

CUTOFF

This knob sets the Cutoff Frequency for the Filter, from 20 Hz to 20k Hz. Frequencies below the Cutoff Frequency will be allowed to pass; frequencies above the Cutoff Frequency will be attenuated at a rate of 24 dB per octave.

Turning the **CUTOFF** knob clockwise opens the filter by raising the Cutoff Frequency, resulting in a brighter and more articulate sound. Turning the **CUTOFF** knob counter-clockwise closes the filter by lowering the Cutoff Frequency, resulting in a thicker or darker sound.

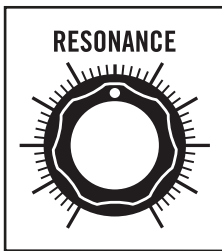

RESONANCE

Resonance allows a certain amount of signal from the filter's output to be routed back to the filter's input. This action gives added sonic emphasis via a resonant peak that occurs at the Filter Cutoff Frequency.

Turn the **RESONANCE** knob clockwise to increase the level of this resonant peak. Turn the **RESONANCE** knob counter-clockwise to decrease the level of this resonant peak. Pushing the **RESONANCE** level to its maximum and lowering the **CUTOFF** value can cause the filter to self-oscillate.

■ THE AMPLIFIER (VCA)

Before the sound leaves your Subharmonicon, it passes through the Voltage Controlled Amplifier to attain the desired level. It is here that the Subharmonicon volume can be controlled.

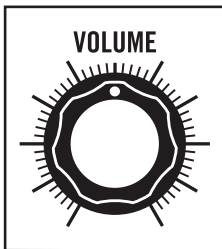

VOLUME

The output level of the **AUDIO OUT /** jack is controlled via this knob. Rotating this knob clockwise increases the Volume, rotating this knob counter-clockwise decreases the Volume.

■ THE ENVELOPE GENERATORS (EG)

An envelope generator creates a control voltage that changes in value over time. Subharmonic contains two envelope generators, each with an Attack stage and a Decay stage. The first EG adds control to the Cutoff Frequency of the VCF, or filter; the second EG adds control to the output level of the VCA.

VCF EG

The VCF EG produces a time-variant control voltage that modulates the setting of the VCF Cutoff Frequency.



VCF ATTACK

The **VCF ATTACK** knob determines how much time is required for the Attack stage of the VCF EG to rise (or fall) from the level specified by the **CUTOFF** knob to the maximum Cutoff Frequency achieved using the **VCF EG AMT** knob, with a range of 1 millisecond to 10 seconds. Once a trigger or gate is received by Subharmonic — either from the internal sequencer or from an external keyboard, via MIDI, etc. — the VCF EG will begin its cycle.

NOTE: The Subharmonic VCF EG is unique in that, while in the Attack phase, the VCF EG will not restart even when a new trigger or gate is received. Only once the Attack phase has been completed can a new trigger or gate be received to restart the VCF EG.

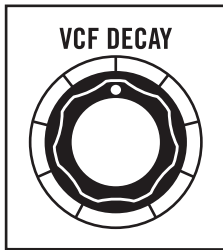

VCF DECAY

The **VCF DECAY** knob determines how much time is required for the Decay stage of the VCF EG to fall or rise from the Cutoff Frequency achieved using the **VCF EG AMT** knob to the level specified by the **CUTOFF** knob, with a range of 5 milliseconds to 10 seconds. When a trigger is received, the VCF EG will complete the Attack stage, and then proceed to the Decay stage. When a gate is received, the VCF will complete the Attack stage and hold at the maximum level until the gate ends, at which point the Decay stage will begin.

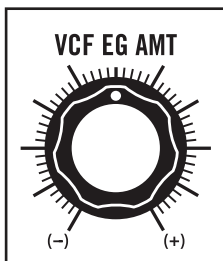

VCF EG AMT

This knob controls the amount, or depth, of change to the Cutoff Frequency caused by the VCF EG. Also note that this knob is bi-directional, with both positive (clockwise) and inverse (counter-clockwise) values. In the center position, the VCF EG has no effect. Positive (+) values will cause the VCF EG to open the filter on the Attack stage, and close the filter on the Decay stage. Inverse (-) values will close the filter during the Attack stage, and open the filter on the Release stage.

VCA EG

The VCA EG produces a time-variant control voltage that modulates the attack and decay of the Volume level.



VCA ATTACK

The **VCA ATTACK** knob determines how much time is required for the Attack stage of the VCA EG to rise from zero to the level specified by the **VOLUME** knob, from 1 millisecond to 10 seconds. Once a trigger or gate is received by Subharmonic — either from the internal sequencer or from an external keyboard, via MIDI, etc. — the VCA EG will begin its cycle.

NOTE: The Subharmonic VCA EG is unique in that while in the Attack phase, the VCA EG will not restart even when a new trigger or gate is received. Only after the Attack phase has been completed can a new trigger, or gate, be received to restart the VCA EG.

THE ENVELOPE GENERATORS (EG) *(Continued)*

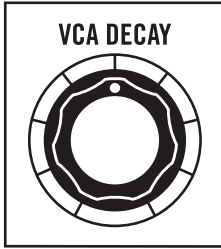

VCA DECAY

The **VCF DECAY** knob determines how much time is required for the Decay stage of the VCA EG to fall from the level specified by the **VOLUME** knob to zero, from 5 milliseconds to 10 seconds. When a trigger is received, the VCA EG will complete the Attack stage, and then proceed to the Decay stage. When a gate is received, the VCA will complete the Attack stage and hold at the maximum level until the gate ends, at which point the Decay stage will begin.

■ TEMPO

Much of the Subharmonic performance is derived from the **TEMPO** setting. This knob sets a base clock rate that drives the timing of the four rhythm generators, which in turn drives the timing of the two sequencers.

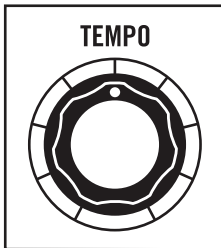

TEMPO

The **TEMPO** knob sets the initial clock rate for the sequencers and the rhythm generators. The range of the **TEMPO** knob is from .333 Hz to 50 Hz. In the more musical measure of tempo, this equates to a range of 20 BPM to 3,000 BPM (Beats Per Minute), assuming 1 PPQ (Pulse Per Quarter-note).

NOTE: An analog clock signal connected to the **CLOCK** input jack of the patchbay will override the internal clock and this **TEMPO** knob. A MIDI clock signal connected to the **MIDI IN** input jack of the patchbay (using a five-pin DIN socket to 1/8" plug TYPE A MIDI connector, such as the one provided with your Subharmonic) will override both the internal clock and any analog clock signals connected to the **CLOCK** input jack.

NOTE: Internal clock is 1 PPQ until a MIDI clock is detected. When MIDI clock is present, the PPQ is 4 (16th notes).

THE SEQUENCERS

Subharmonic contains two identical sequencers. Each sequencer features four individual steps. Each step includes a variable tuning knob and an LED to indicate the current active step. Sequencer 1 is tied internally to OSC 1 and the subharmonic oscillators associated with OSC 1, and Sequencer 2 is tied internally to OSC 2 and the subharmonic oscillators associated with OSC 2. In order for a sequencer to play, it must receive clock information from at least one of the rhythm generators. Each sequencer may be driven by any or all of the rhythm generators — opening the instrument up to a wide variety of rhythmic possibilities.

NOTE: The patchbay allows the creation of new control paths to augment or replace the normalised sequencer connections. For example, connecting the **SEQ 1** output jack to the **VCO 2** input jack would allow Sequencer 1 to modify the pitch of VCO 2, either alone (**SEQ 2 ASSIGN OSC 2** button off/unlit), or in conjunction with Sequencer 2 (**SEQ 2 ASSIGN OSC 2** button on/lit).

NOTE: Clock information is assigned from the rhythm generators to the sequencers using the corresponding **SEQ 1** or **SEQ 2** buttons (page 30).

SEQUENCER 1

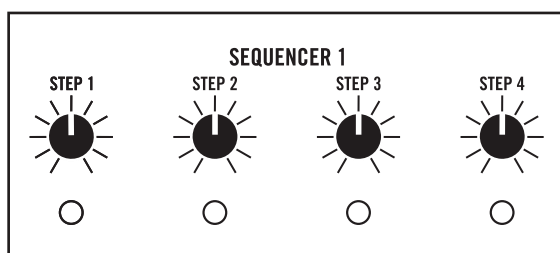

STEP 1 THROUGH STEP 4

The **STEP** knobs individually affect the values set by the **VCO 1 FREQ** knob, and the associated **SUB 1 FREQ**, and/or **SUB 2 FREQ** knobs, based on the **SEQ 1 ASSIGN** buttons defined below. In the center position, no change is applied. Rotating the **STEP** knob clockwise will add a positive control voltage to the selected frequency settings, producing a higher pitch for this step. Rotating the **STEP** knob counter-clockwise will subtract (by adding a negative control voltage) from the selected frequency settings, producing a lower pitch for this step.

NOTE: The behavior of the individual **STEP** knobs is also determined by the current setting of the **QUANTIZE** button and the **SEQ OCT** button.

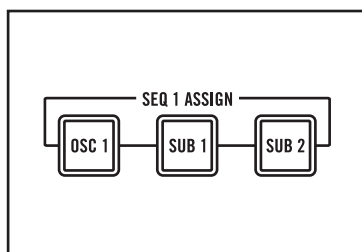

SEQ 1 ASSIGN (VCO 1)

These buttons allow the output of Sequencer 1 to be assigned to control the pitch of OSC 1 (VCO 1), the integer value of SUB 1, the integer value of SUB 2, or any combination of the three.

OSC 1: When this button is engaged (lit), the output of Sequencer 1, as defined by the positions of the four **STEP** knobs, will modify the value of the **VCO 1 FREQ** knob. The pitch of SUB 1 and SUB 2 will also change, as they maintain their constant harmonic relationship to VCO 1.

SUB 1: When this button is engaged (lit), the output of Sequencer 1, as defined by the positions of the four **STEP** knobs, will modify the integer value of the **SUB 1 FREQ** knob. When this button is off (unlit), SUB 1 will continue to play using the setting of the **SUB 1 FREQ** knob, maintaining a constant harmonic relationship to VCO 1.

THE SEQUENCERS *(Continued)*

SEQ 1 ASSIGN (VCO 1) *(Continued)*

SUB 2: When this button is engaged (lit), the output of Sequencer 1, as defined by the positions of the four **STEP** knobs, will modify the integer value of the **SUB 2 FREQ** knob. When this button is off (unlit), SUB 2 will continue to play using the setting of the **SUB 2 FREQ** knob, maintaining a constant harmonic relationship to VCO 1.

SEQUENCER 2

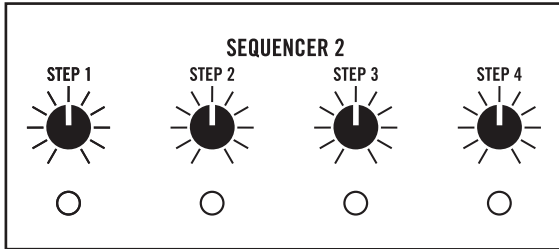

STEP 1 THROUGH STEP 4

The **STEP** knobs individually affect the values set by the **VCO 2 FREQ** knob, and the associated **SUB 1 FREQ**, and/or **SUB 2 FREQ** knobs, based on the **SEQ 2 ASSIGN** buttons defined below. In the center position, no change is applied. Rotating the **STEP** knob clockwise will add a control signal to the selected frequency settings, producing a higher pitch for this step. Rotating the **STEP** knob counter-clockwise will subtract (by adding a negative control signal) from the selected frequency settings, producing a lower pitch for this step.

***NOTE:** The behavior of the individual **STEP** knobs is also determined by the current setting of the **QUANTIZE** button and the **SEQ OCT** button.*

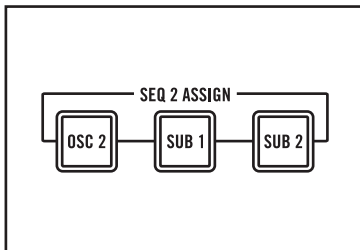

SEQ 2 ASSIGN (VCO 2)

These buttons allow the individual steps of Sequencer 2 to be assigned to control the pitch of OSC 2 (VCO 2), the integer value of SUB 1, the integer value of SUB 2, or any combination of the three.

OSC 2: When this button is engaged (lit), the output of Sequencer 2, as defined by the positions of the four **STEP** knobs, will modify the value of the **VCO 2 FREQ** knob. The pitch of SUB 1 and SUB 2 will also change as they maintain their constant harmonic relationship with VCO 2.

SUB 1: When this button is engaged (lit), the output of Sequencer 2, as defined by the positions of the four **STEP** knobs, will modify the value of the **SUB 1 FREQ** knob. When this button is off (unlit), SUB 1 will continue to play using the setting of the **SUB 1 FREQ** knob, maintaining a constant harmonic relationship to VCO 2.

SUB 2: When this button is engaged (lit), the output of Sequencer 2, as defined by the positions of the four **STEP** knobs, will modify the value of the **SUB 2 FREQ** knob. When this button is off (unlit), SUB 2 will continue to play using the setting of the **SUB 2 FREQ** knob, maintaining a constant harmonic relationship to VCO 2.

THE SEQUENCERS *(Continued)*

SHARED SEQUENCER PARAMETERS

The setting of the **SEQ OCT** function is shared by both Sequencers; it cannot be set individually.

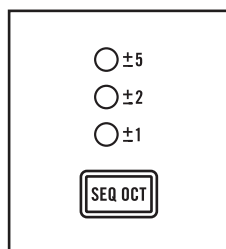

SEQ OCT

This function specifies the octave range available for each of the **STEP** knobs in the sequencers. There are three values for this parameter. Repeatedly pressing the **SEQ OCT** button will cycle through the available options, with an LED indicating the current selection.

±5: This option provides five octaves above and five octaves below the current **VCO FREQ** knob value for each individual step.

±2: This option provides two octaves above and two octaves below the current **VCO FREQ** knob value for each individual step.

±1: This option provides one octave above and one octave below the current **VCO FREQ** knob value for each individual step.

NOTE: The sequencers cannot internally modulate the frequency of the VCOs any higher than 10k Hz (approximately). For full use of the ±5 Sequencer Octave range, set the **VCO 1 FREQ** and **VCO 2 FREQ** knobs fully counter-clockwise at the Middle C position. In addition, subharmonic content cannot be accurately generated above 10k Hz. It is important to be aware of these details because the VCO frequency setting and individual Sequencer Step values are summed with the VCO CV inputs, which can drive the VCOs far above 10k Hz.

NOTE: By default, the **SEQ 1** and **SEQ 2** output jacks will output a control voltage that reflects the current Seq Oct settings. This behavior can be disengaged by pressing and holding the **SEQ OCT** button until the LED flashes, at which point the **SEQ 1** and **SEQ 2** output jacks will output at ±5, regardless of the Seq Oct setting. In this mode, the oscillators will continue to respect the Seq Oct settings. Press and hold the **SEQ OCT** button until the LED stops flashing to return to the default.

TRANSPORT CONTROLS

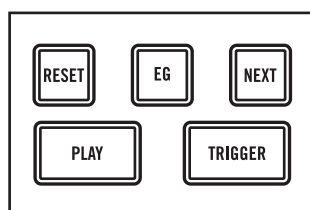

This set of controls affect the sequencers, the rhythm generators, envelope behavior, as well as handling of internal and external clock signals.

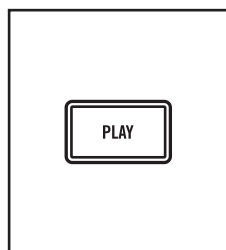

PLAY

The **PLAY** button starts and stops the playback of the sequencers. When the **PLAY** button is lit, the sequencers are playing. When the **PLAY** button is unlit, playback has stopped.

NOTE: This button will also start and stop the rhythm generators, and will stop (when unlit) the clock signal sent from the **CLOCK** output jack.

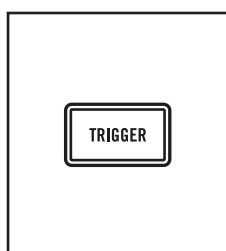

TRIGGER

The function of the **TRIGGER** button is determined by the **EG** button (page 29). If the **EG** button is On (lit), pressing the **TRIGGER** button will instantly restart the envelope generators (VCF EG and VCA EG) without waiting for the next step of the sequencer(s). Note that the EGs will **NOT** restart if they are currently in the Attack stage.

TRANSPORT CONTROLS *(Continued)*

TRIGGER *(Continued)*

If the **EG** button is Off (unlit), the **TRIGGER** button behaves as a gate, and the envelopes are held to their maximum levels (based on their current settings) as long as the **TRIGGER** button is held down. When the **TRIGGER** button is released, the Decay phase of the EGs will begin, allowing an extra degree of control over the EG. If the **EG** button is in the Held position (blinking), then the EGs are already being held to their maximum levels, and the **TRIGGER** button will have no effect.

NOTE: This button is also linked to the output of the rhythm generators and the trigger inputs. The combined signal is sent to the **TRIGGER** output jack.

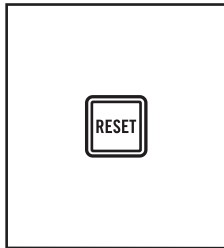

RESET

Pressing the **RESET** button will instantly reset the sequencers to Step 1, and will reset the rhythm generators to their initial phase or starting point. If the **PLAY** button is lit when the **RESET** button is pressed, the sequencers will begin again on the next clock pulse. If the **PLAY** button was unlit when the **RESET** button was pressed, the sequencers will not restart until the **PLAY** button is pressed again.

Holding the **RESET** button down will act as a Hold function. The sequencers will reset to Step 1, but will not advance to the next step. However, the EGs will continue to be triggered by the rhythm generators assigned to that sequencer. Pressing the **NEXT** button while the **RESET** button is being held down will advance the sequencer(s) to the next step, where the EGs will continue to be triggered by the rhythm generators assigned to the sequencer(s). Normal playback will resume when the **RESET** button has been released.

NOTE: This button is combined with the **RESET** input jack.

TIP: Using the **RESET** button is a handy way to bring everything (sequencers, rhythm generators, EGs, etc.) back to a single starting point during performance in order to begin a second verse, move to the chorus, start a new section, or even create a stuttered one-count, etc.

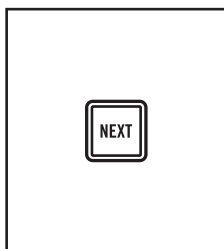

NEXT

Pressing the **NEXT** button will immediately advance to the next step of the sequencer(s).

NOTE: Pressing the **NEXT** button will not cause the VCF EG or the VCA EG to re-trigger, except as defined when holding down the **RESET** button (above), or if a gate signal is being received at the **RESET** input jack.

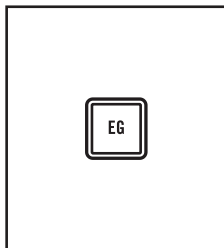

EG

The **EG** (Envelope Generator) button has three settings; Off (button is unlit), On (button is lit), and Held (button blinks). Quickly press the **EG** button to toggle between the On and Off settings. Hold the **EG** button until it begins to blink to select the Held setting.

OFF: This setting prevents the individual sequencer steps from triggering the EGs. The **TRIGGER** button and external trigger pulses continue to trigger the EGs, and are passed to the **TRIGGER** output jack.

ON: This setting allows the individual sequencer steps to trigger the EGs. All of the manual triggers, external triggers, and triggers created by the sequencers are passed to the **TRIGGER** output jack.

TRANSPORT CONTROLS *(Continued)*

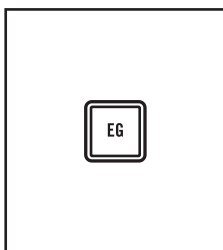

EG *(Continued)*

HELD: Briefly hold the **EG** button until it begins to blink to select the Held setting. When the **EG** button is blinking, the VCF EG and VCA EG are held open at their maximum values until the **EG** button is pressed once again. With playback stopped (**PLAY** button unlit), the **NEXT** button can be used to advance to the next sequencer step. This allows you time to manually tune each VCO and each subharmonic oscillator with precision, as well as each sequencer step, based on the **SEQ 1 ASSIGN** and **SEQ 2 ASSIGN** buttons.

NOTE: When entering the Held option, the EGs will initiate and complete their respective Attack stages, and then hold at their maximum values. When exiting the Held option, the EGs will complete their respective Decay stage.

THE POLYRHYTHM SECTION

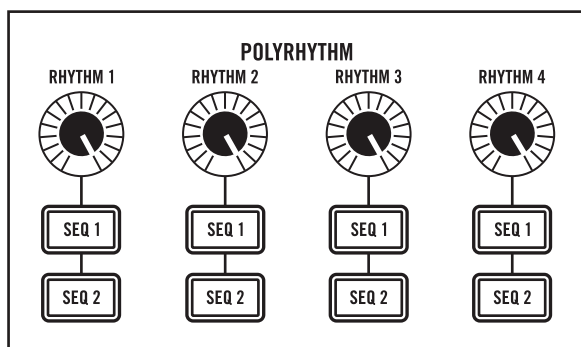

Subharmonic contains four independent, but identical, rhythm generators. In short, each rhythm generator creates a new rhythm by dividing the current tempo by an integer value from 1 to 16, selected by a dedicated **RHYTHM** knob. This new rhythm is then superimposed onto Sequencer 1, Sequencer 2, or both, via the **SEQ 1** and **SEQ 2** buttons associated with each Rhythm Generator.

Each rhythm generator creates one rhythm. But as you begin to combine multiple rhythm generators to drive the sequencers, you will start to explore the potential of polyrhythmic composition. Changing the SEQ 1 and SEQ 2 assignments and using the **RESET** button as you play adds rich levels of phrasing to your Subharmonic performance.

NOTE: The rhythm generators can be based on the internal clock (**TEMPO** knob), an external analog clock signal, or a MIDI clock signal.

Because each rhythm generator functions in an identical manner, we will use **RHYTHM 1** as the example.

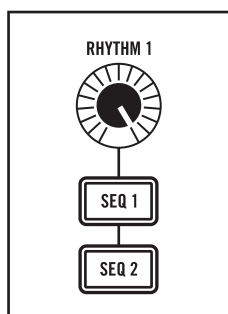

RHYTHM 1

Rotating this knob chooses an integer value from 1 (fully clockwise) to 16 (fully counter-clockwise). This integer is used to divide the current clock/tempo setting to create a new rhythm.

NOTE: Rotating the **RHYTHM 1** knob fully clockwise divides the current tempo by 1, which is equal to the current tempo. This allows you to hear the original rhythm at any time by rotating the **RHYTHM 1** knob fully clockwise.

SEQ 1

Engaging this button (lit) takes the tempo / rhythm created by the position of the **RHYTHM** knob and uses it to advance through the steps of Sequencer 1.

SEQ 2

Engaging this button (lit) takes the tempo / rhythm created by the position of the **RHYTHM** knob and uses it to advance through the steps of Sequencer 2.

THE PATCHBAY

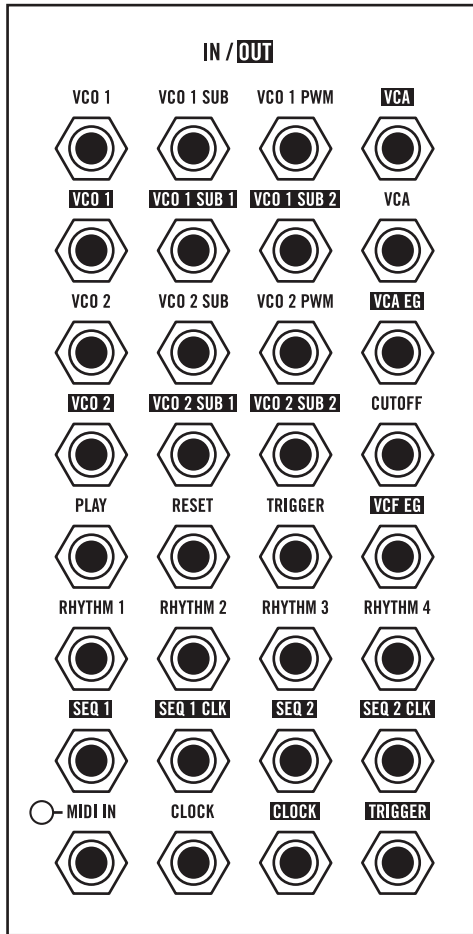

True to its semi-modular nature, Subharmonic is equipped with an extensive patchbay that allows creative connections to other electronic music modules and Eurorack synthesizer systems. These convenient patch points also allow the creation of new control and signal pathways within Subharmonic itself. Subharmonic contains a total of 32 patch points. Of these, 17 are inputs, identified by normal text on the panel. The remaining 15 are outputs, indicated by reversed-color text over an inverse background. The Patchbay is designed to work with 3.5mm patch cables only. A set of five is included in your box. If you should need more, Moog patch cables are available through authorized Moog Dealers.

INPUTS:

VCO 1
VCO 1 SUB
VCO 1 PWM
VCA
VCO 2
VCO 2 SUB
VCO 2 PWM
CUTOFF
PLAY
RESET
TRIGGER
RHYTHM 1
RHYTHM 2
RHYTHM 3
RHYTHM 4
MIDI IN (page 37)
CLOCK

OUTPUTS:

VCA
VCO 1
VCO 1 SUB 1
VCO 1 SUB 2
VCA EG
VCO 2
VCO 2 SUB 1
VCO 2 SUB 2
VCF EG
SEQ 1
SEQ 1 CLK
SEQ 2
SEQ 2 CLK
CLOCK
TRIGGER

ROW ONE

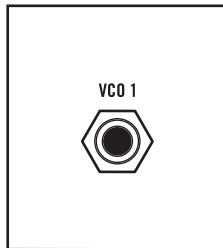

VCO 1 INPUT

This input accepts a 1-volt/octave control signal to modify the frequency of VCO 1. The value of this signal is summed with the value set by the **VCO 1 FREQ** knob and the individual Sequencer 1 **STEP** knobs.

CV INPUT: -5V to +5V

NOTE: The signal received here to control VCO 1 is normalised to control VCO 2 as well. Connecting a patch cable to the VCO 2 input jack will disable this normalised connection.

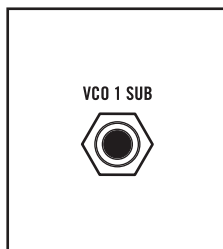

VCO 1 SUB INPUT

This input accepts a control signal to choose the value (1-16) of the VCO 1 Subharmonic Oscillators; the **SUB 1 FREQ** and **SUB 2 FREQ** (VCO 1) knobs should be centered to receive bi-directional (+/-) control voltages.

CV INPUT: -5V to +5V

THE PATCHBAY *(Continued)*

ROW ONE *(Continued)*

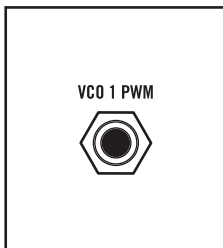

VCO 1 PWM INPUT

Connect a control voltage to this input to modulate the Pulse Width of VCO 1 and of the SUB 1 and SUB 2 subharmonic oscillators associated with VCO 1. In order to hear the effect, the Square wave must be selected using the **VCO 1 WAVE** switch. A connection made here overrides the internal connection (subharmonic oscillator sawtooth 1) used to control PWM with the **VCO 1 WAVE** switch in the center position.

CV INPUT: -5V to +5V

(1% Duty Cycle/Narrow Pulse to 99% Duty Cycle/Wide Pulse)

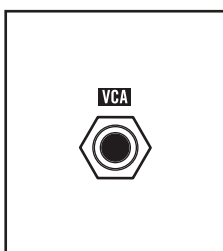

VCA OUTPUT

This output jack provides a Subharmonic output signal at the Eurorack level.

AUDIO OUTPUT: 10V peak to peak

ROW TWO

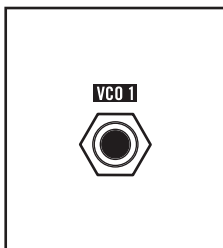

VCO 1 OUTPUT

The audio output of VCO 1 is available at this jack.

AUDIO/CV OUTPUT: 10V peak to peak

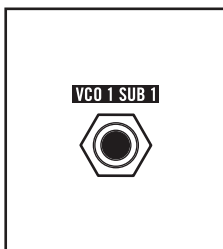

VCO 1 SUB 1 OUTPUT

The audio signal of VCO 1, Subharmonic Oscillator 1 is available here.

AUDIO/CV OUTPUT: 10V peak to peak

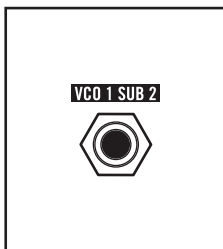

VCO 1 SUB 2 OUTPUT

The audio signal of VCO 1, Subharmonic Oscillator 2 is available here.

AUDIO/CV OUTPUT: 10V peak to peak

THE PATCHBAY *(Continued)*

ROW TWO *(Continued)*

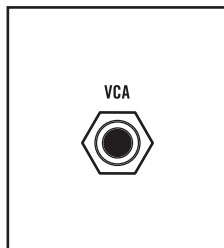

VCA INPUT

Connecting a control signal to this input will raise or lower the output of the VCA, or more simply, the volume. The control signal connected here is summed with the output control signal of the VCA EG.

CV INPUT: 0V to +8V

ROW THREE

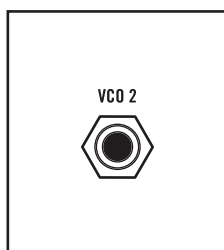

VCO 2 INPUT

This input accepts a 1-volt/octave control signal to modify the frequency of VCO 2. The value of this signal is summed with the value set by the **VCO 2 FREQ** knob and the individual Sequencer 2 **STEP** knobs.

CV INPUT: -5V to +5V

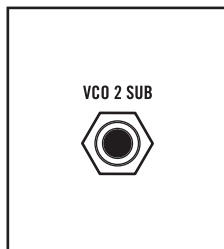

VCO 2 SUB INPUT

This input accepts a control signal to choose the value (1-16) of the VCO 2 Subharmonic Oscillators; the **SUB 1 FREQ** and **SUB 2 FREQ** (VCO 2) knobs should be centered to receive bi-directional (+/-) control voltages.

CV INPUT: -5V to +5V

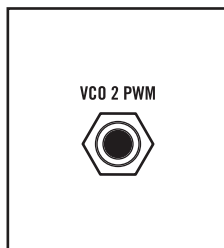

VCO 2 PWM INPUT

Connect a control voltage to this input to modulate the Pulse Width of VCO 2 and of the SUB 1 and SUB 2 subharmonic oscillators associated with VCO 2. The Square wave must be selected using the **VCO 2 WAVE** switch. A connection made here overrides the internal connection (subharmonic oscillator sawtooth 2) used to control PWM with the **VCO 2 WAVE** switch in the center position.

CV INPUT: -5V to +5V

(1% Duty Cycle/Narrow Pulse to 99% Duty Cycle/Wide Pulse)

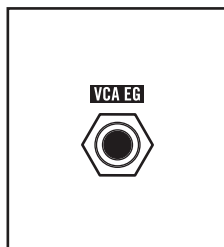

VCA EG OUTPUT

The control signal created by the VCA EG (Envelope) is available via this jack.

CV OUTPUT: 0V to +8V

THE PATCHBAY *(Continued)*

ROW FOUR

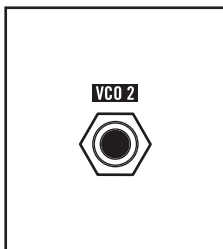

VCO 2 OUTPUT

The audio output of VCO 2 is available at this jack.

AUDIO/CV OUTPUT: 10V peak to peak

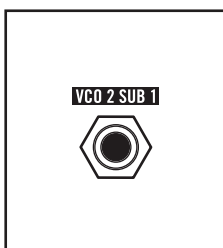

VCO 2 SUB 1 OUTPUT

The audio signal of VCO 2, Subharmonic Oscillator 1 is available here.

AUDIO/CV OUTPUT: 10V peak to peak

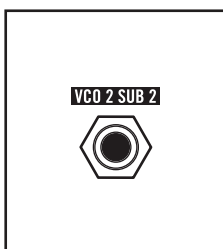

VCO 2 SUB 2 OUTPUT

The audio signal of VCO 2, Subharmonic Oscillator 2 is available here.

AUDIO/CV OUTPUT: 10V peak to peak

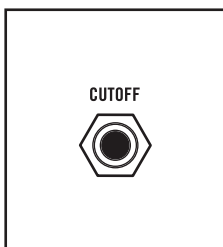

CUTOFF INPUT

A control signal connected to this input jack can be used to control the Cutoff Frequency of the Subharmonic Filter. With the **CUTOFF** knob centered, the signal received here can sweep the Cutoff Frequency through a range of up to ± 5 octaves.

CV INPUT: -5V to +5V

ROW FIVE

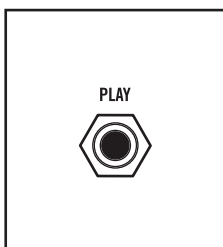

PLAY INPUT

A gate signal received here will toggle the status of the **PLAY** button. The **PLAY** button is still available for manual operation. Pressing the **PLAY** button will override the status of the **PLAY** button caused by a control signal received here.

CV INPUT: 0V to +10V

(Rising edge = PLAY begins; Falling edge = PLAY stops)

THE PATCHBAY *(Continued)*

ROW FIVE *(Continued)*

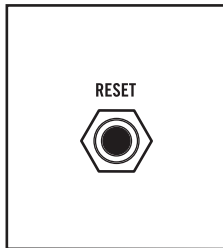

RESET INPUT

A trigger signal received here will reset the sequencers to Step 1, and will reset the rhythm generators to their initial phase or starting point. If the **PLAY** button was lit when the trigger was received, the sequencers will begin again on the next clock pulse. If the **PLAY** button was unlit when the trigger was received, the sequencers will not restart until the **PLAY** button is pressed again. A gate signal received here will act as a Hold function. The sequencers will reset to Step 1, but will not advance to the next step until the gate signal has ended. However, the EGs will continue to be triggered by the rhythm generators

assigned to that sequencer. Pressing the **NEXT** button while the gate signal is being received will advance the sequencers to the next step, where the EGs will continue to be triggered by the rhythm generators assigned to that sequencer. Normal playback will resume when the gate signal has ended.

CV INPUT: 0V to +10V

(Rising edge = TRIGGER; Continuous high voltage = GATE)

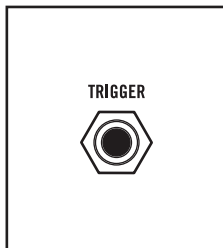

TRIGGER INPUT

A control signal received here will trigger the VCF EG and the VCA EG (Envelopes) to begin their cycles. Note that the EGs will **NOT** restart if they are currently in the Attack stage.

CV INPUT: 0V to +10V

(Rising edge = TRIGGER)

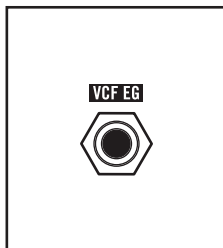

VCF EG OUTPUT

The control signal created by the VCF EG (Envelope) is available via this jack.

CV OUTPUT: 0V to +8V

ROW SIX



RHYTHM 1 INPUT

A control signal connected to this input sets the timing of Rhythm Generator 1 by controlling the value of the **RHYTHM 1** knob, thereby selecting the integer value (1-16) used to divide the current tempo. **RHYTHM 1** knob should be centered for the best range.

CV INPUT: -5V to +5V



RHYTHM 2 INPUT

A control signal connected to this input sets the timing of Rhythm Generator 2 by controlling the value of the **RHYTHM 2** knob, thereby selecting the integer value (1-16) used to divide the current tempo. **RHYTHM 2** knob should be centered for the best range.

CV INPUT: -5V to +5V

THE PATCHBAY *(Continued)*

ROW SIX *(Continued)*



RHYTHM 3 INPUT

A control signal connected to this input sets the timing of Rhythm Generator 3 by controlling the value of the **RHYTHM 3** knob, thereby selecting the integer value (1-16) used to divide the current tempo. **RHYTHM 3** knob should be centered for the best range.

CV INPUT: -5V to +5V



RHYTHM 4 INPUT

A control signal connected to this input sets the timing of Rhythm Generator 4 by controlling the value of the **RHYTHM 4** knob, thereby selecting the integer value (1-16) used to divide the current tempo. **RHYTHM 4** knob should be centered for the best range.

CV INPUT: -5V to +5V

ROW SEVEN

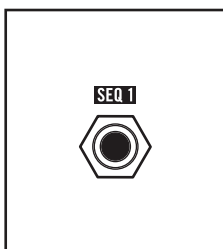

SEQ 1 OUTPUT

The control signal available via this output reflects the value of the control voltage created by the current step of Sequencer 1 and respects the settings of both the **QUANTIZE** button and the **SEQ OCT** button.

CV OUTPUT: -5V to +5V

NOTE: The Sequencer outputs can be de-coupled from the Quantize setting (page 21) and/or the Seq Oct setting (page 28).



SEQ 1 CLK OUTPUT

A clock signal based on the tempo of Sequencer 1 is available here.

CV OUTPUT: 0V to +5V



SEQ 2 OUTPUT

The control signal available via this output reflects the value of the control voltage created by the current step of Sequencer 2 and respects the settings of both the **QUANTIZE** button and the **SEQ OCT** button.

CV OUTPUT: -5V to +5V

NOTE: The Sequencer outputs can be de-coupled from the Quantize setting (page 21) and/or the Seq Oct setting (page 28).

THE PATCHBAY *(Continued)*

ROW SEVEN *(Continued)*

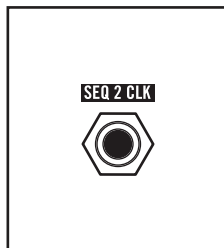

SEQ 2 CLK OUTPUT

A clock signal based on the tempo of Sequencer 2 is available here.

CV OUTPUT: 0V to +5V

ROW EIGHT

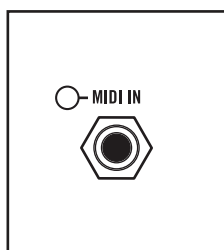

MIDI IN INPUT

MIDI information is received via this jack using the five-pin DIN socket to 3.5mm MINI jack (MIDI Type A) adapter included with your Subharmonic. Specifically, Subharmonic can receive master clock (**TEMPO**) information, note data, and various CC (Control Change) messages via MIDI (see MIDI Operations table on page 44). Clock information from a connected MIDI source will override the internal clock setting and any connected external analog clock source. The corresponding LED indicates that MIDI data is being received.

MIDI INPUT: MIDI data

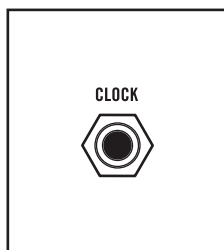

CLOCK INPUT

A clock signal received via this jack will override the internal clock setting.

CLOCK/CV INPUT: 0V to +10V
(Rising edge = Clock Pulse)

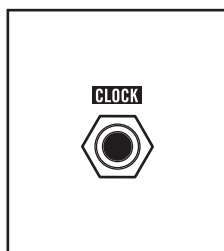

CLOCK OUTPUT

The clock signal available from this jack reflects the current clock source, be it internal, external, or MIDI. The clock signal is only present while the sequencer(s) are playing and the **PLAY** button is lit.

CLOCK/CV OUTPUT: 0V to +10V

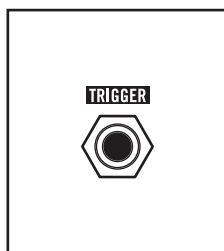

TRIGGER OUTPUT

Each time the VCA or VCF Envelope Generators (EG) are triggered – either by the sequencers or by the **TRIGGER** button – a trigger signal will be sent from this output.

TRIGGER/CV OUTPUT: 0V to +5V Pulse; 1 millisecond

■ USING SUBHARMONICON TO CLOCK YOUR DFAM

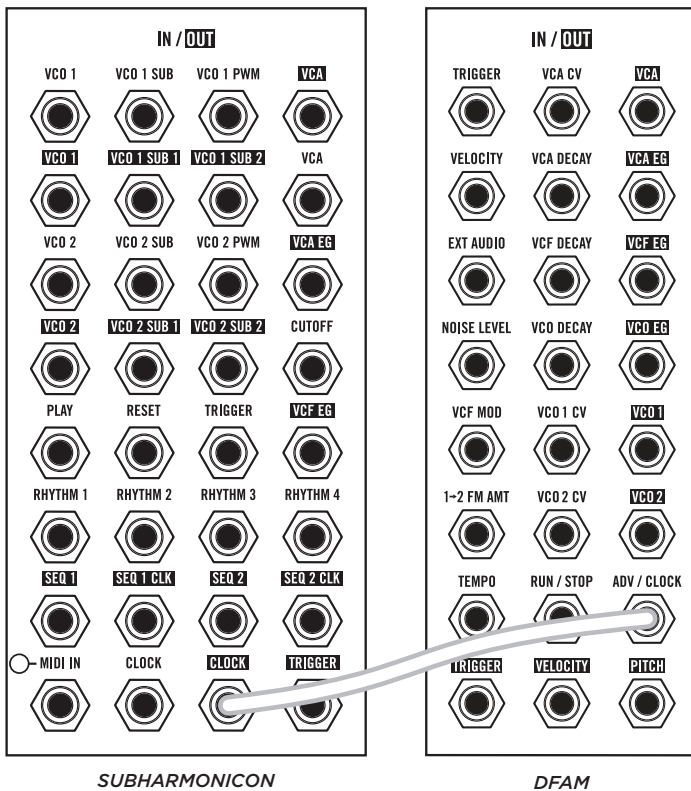

Use a patch cable to connect the Subharmonic **CLOCK** output jack to the DFAM **ADV/CLOCK** input jack.

This will allow Subharmonic to serve as the clock for both units.

TIP: You can also clock DFAM by using the Subharmonic **TRIGGER** output, or the **SEQ 1 CLK** and **SEQ 2 CLK** outputs to clock DFAM with a polyrhythm.

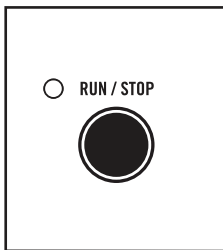

Before you press the Subharmonic **PLAY** button, press the **RUN/STOP** button on your DFAM. This will ensure that it is ready to play when it begins to receive the Subharmonic clock signal.

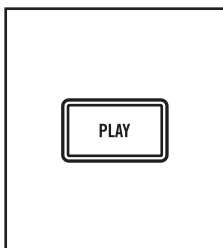

Press the Subharmonic **PLAY** button. Both units should now be playing in sync.

■ SYNCING SUBHARMONICON TO YOUR MOTHER-32

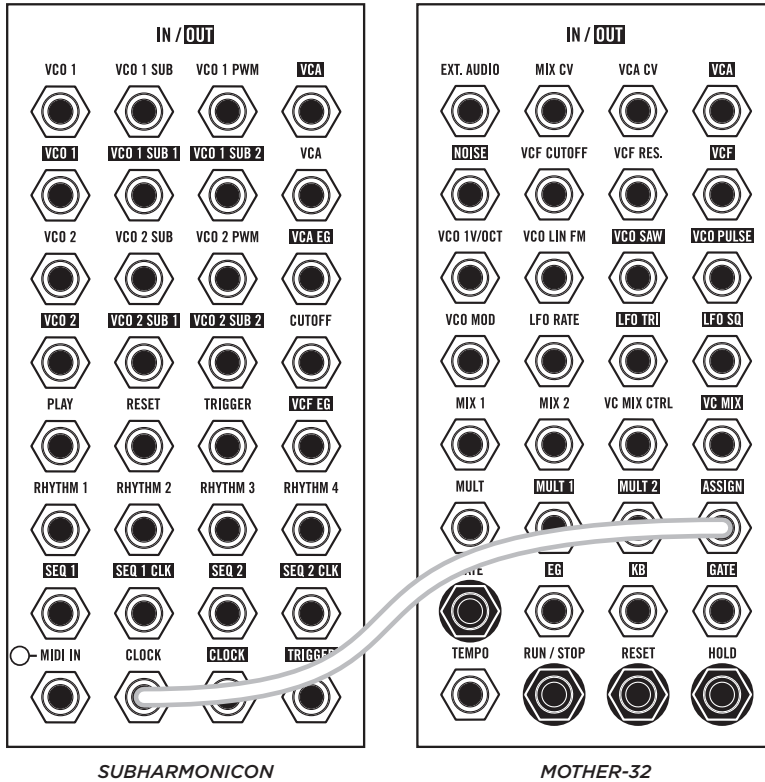

Use a patch cable to connect the Mother-32 **ASSIGN** output jack to the Subharmonic **CLOCK** input jack.

This will allow Mother-32 to serve as the clock for both units.

NOTE: Setting the **ASSIGN** output jack to **CLOCK** is described on page 44 of the Mother-32 manual.

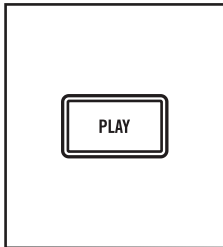

Before you press the Mother-32 **RUN/STOP (REC)** button, press the **PLAY** button on your Subharmonic. This will ensure that it is ready to play when it begins to receive a clock signal from your Mother-32.

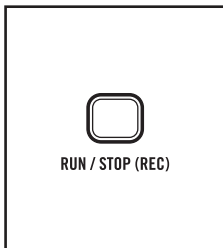

Press the **RUN/STOP (REC)** button on the Mother-32. Both units should now be playing in sync.

TIP: Mother-32 can transmit different clock divisions depending on its internal settings. Experimenting with these clock divisions allows Subharmonic to play in sync with Mother-32, but at a division of the master tempo.

■ USING SUBHARMONICON AS A EURORACK MODULE

Your Subharmonic can be removed from its case and easily installed into a Eurorack system as a 60HP module. Before doing this, it is important to note that Subharmonic draws a maximum of 360mA from a +12V rail. It does not use the -12V rail at all. Make sure there is enough headroom on the +12V rail in your system to power the Subharmonic.

NOTE: You will need to know the current rating of the system's +12VDC rail and the current draw of the +12VDC rail from all modules in the system combined. The sum of all current draw at +12VDC should never exceed the power supply rating. Note that it is good practice to leave some headroom to reduce stress on the power supply.

Moog accepts NO responsibility or liability for improperly installed modules.

TO INSTALL THE SUBHARMONICON IN A EURORACK SYSTEM

1. Disconnect external power from the unit.
2. Remove the eight black M3 screws on the front panel and keep them somewhere safe. You will need them again.
3. Slowly lift the panel from the case, so that you can see the two cables going to the front panel module.
4. Disconnect these two cables from the front panel. The module is now free from its enclosure.

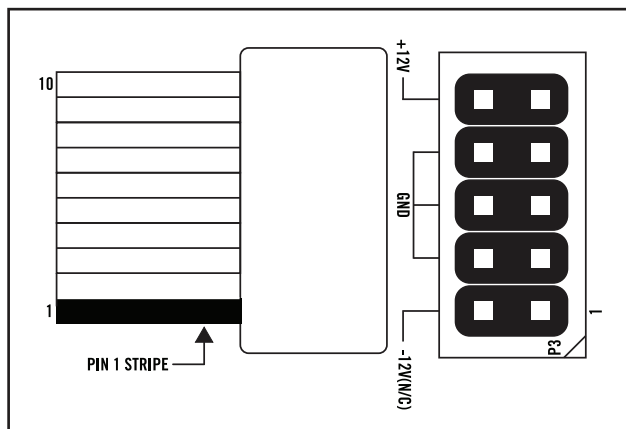

5. Look at the back of your Subharmonic module. There is a 10-pin power header on the back of the PCB that accepts a 10-pin Eurorack power ribbon cable (not included).

6. Connect PIN-1 (-12V) of the power ribbon cable to PIN-1 of the Subharmonic Eurorack power header. The darkened wire (typically red) on the ribbon cable indicates the PIN-1 (-12V) side of the cable.

7. After power is connected, your Subharmonic may be installed into the rails of the Eurorack system case with the eight black M3 screws removed in Step 2.

8. Once fully installed, you may power up your Eurorack system.

■ GLOBAL PARAMETERS

These parameters affect the overall Subharmonic operation.

FINE TUNE

Using the Fine Tune mode, the overall pitch of your Subharmonic can be adjusted by ± 50 cents (one-half semitone up or down). This allows Subharmonic to be matched to your other equipment, a particular piece of gear, an out-of-tune track, etc. The default value is zero. If you dial in a specific Fine Tune value (an offset from the original pitch), this value will be stored and will be present every time your Subharmonic is powered up, or until a new value is set.

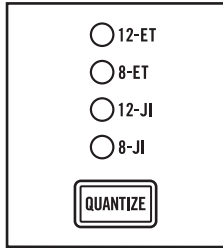

Press and hold the **OSC 1** and **OSC 2** buttons simultaneously until all four of the **QUANTIZE** LEDs begin to flash. This indicates the Fine Tune mode.

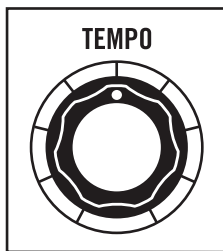

Use the **TEMPO** knob to adjust the Fine Tune amount. The center position provides no change in tuning. Rotating the **TEMPO** knob clockwise will increase the Fine Tune setting by a maximum of 50 cents. Rotating the **TEMPO** knob counter-clockwise will decrease the Fine Tune setting by a maximum of 50 cents.

Press the **QUANTIZE** button to exit the Fine Tune mode. The four **QUANTIZE** LEDs will stop blinking.

■ MIDI OPERATIONS

In addition to receiving MIDI clock information, Subharmonicon can also respond to the following MIDI CC (Control Change) messages.

MIDI note data received by Subharmonicon is referenced as an offset from the note C4 (middle C). Rotating the **VCO 1 FREQ** knob and/or **VCO 2 FREQ** knob fully counter-clockwise will place the frequency of each oscillator at C4, so that MIDI note data received by Subharmonicon will be received unchanged.

MIDI CONTROL CHANGE (CC) MESSAGES:

Parameter	MIDI CC#	Default	Range	Remarks
VCO 1 Frequency	4 [MSB]/ 36 [LSB]	0	0 - 127 [MSB] / 0 - 127 [LSB] (14-Bit)	Provides ± 2.5 octaves of control, added to the VCO 1 FREQ knob setting. When the VCO 1 FREQ knob is in the center position, the MIDI CC will sweep the same range as the knob.
VCO 1 SUB 1 Frequency	103	0	0 - 7 = Integer Value 16 8 - 15 = Integer Value 15 16 - 23 = Integer Value 14 24 - 31 = Integer Value 13 32 - 39 = Integer Value 12 40 - 47 = Integer Value 11 48 - 55 = Integer Value 10 56 - 63 = Integer Value 9 64 - 71 = Integer Value 8 72 - 79 = Integer Value 7 80 - 87 = Integer Value 6 88 - 95 = Integer Value 5 96 - 103 = Integer Value 4 104 - 111 = Integer Value 3 112 - 119 = Integer Value 2 120 - 127 = Integer Value 1	MIDI CC replaces the (VCO 1) SUB 1 FREQ knob setting; moving this knob overrides the MIDI CC value.
VCO 1 SUB 2 Frequency	104	0	0 - 7 = Integer Value 16 8 - 15 = Integer Value 15 16 - 23 = Integer Value 14 24 - 31 = Integer Value 13 32 - 39 = Integer Value 12 40 - 47 = Integer Value 11 48 - 55 = Integer Value 10 56 - 63 = Integer Value 9 64 - 71 = Integer Value 8 72 - 79 = Integer Value 7 80 - 87 = Integer Value 6 88 - 95 = Integer Value 5 96 - 103 = Integer Value 4 104 - 111 = Integer Value 3 112 - 119 = Integer Value 2 120 - 127 = Integer Value 1	MIDI CC replaces the (VCO 1) SUB 2 FREQ knob setting; moving this knob overrides the MIDI CC value.
VCO 2 Frequency	12 [MSB]/ 44 [LSB]	0	0 - 127 [MSB] / 0 - 127 [LSB] (14-Bit)	Provides ± 2.5 octaves of control, added to the VCO 2 FREQ knob setting. When the VCO 2 FREQ knob is in the center position, the MIDI CC will sweep the same range as the knob.

MIDI OPERATIONS *(Continued)*

Parameter	MIDI CC#	Default	Range	Remarks
VCO 2 SUB 1 Frequency	105	0	0 - 7 = Integer Value 16 8 - 15 = Integer Value 15 16 - 23 = Integer Value 14 24 - 31 = Integer Value 13 32 - 39 = Integer Value 12 40 - 47 = Integer Value 11 48 - 55 = Integer Value 10 56 - 63 = Integer Value 9 64 - 71 = Integer Value 8 72 - 79 = Integer Value 7 80 - 87 = Integer Value 6 88 - 95 = Integer Value 5 96 - 103 = Integer Value 4 104 - 111 = Integer Value 3 112 - 119 = Integer Value 2 120 - 127 = Integer Value 1	MIDI CC replaces the (VCO 2) SUB 1 FREQ knob setting; moving this knob overrides the MIDI CC value.
VCO 2 SUB 2 Frequency	106	0	0 - 7 = Integer Value 16 8 - 15 = Integer Value 15 16 - 23 = Integer Value 14 24 - 31 = Integer Value 13 32 - 39 = Integer Value 12 40 - 47 = Integer Value 11 48 - 55 = Integer Value 10 56 - 63 = Integer Value 9 64 - 71 = Integer Value 8 72 - 79 = Integer Value 7 80 - 87 = Integer Value 6 88 - 95 = Integer Value 5 96 - 103 = Integer Value 4 104 - 111 = Integer Value 3 112 - 119 = Integer Value 2 120 - 127 = Integer Value 1	MIDI CC replaces the (VCO 2) SUB 2 FREQ knob setting; moving this knob overrides the MIDI CC value.
VCF (EG) ATTACK	23 [MSB]/ 55 [LSB]	0	0 - 127 [MSB] / 0 - 127 [LSB]	MIDI CC replaces the VCF ATTACK knob setting; moving this knob overrides the MIDI CC value.
VCF (EG) DECAY	24 [MSB]/ 56 [LSB]	0	0 - 127 [MSB] / 0 - 127 [LSB]	MIDI CC replaces the VCF DECAY knob setting; moving this knob overrides the MIDI CC value.
VCA (EG) ATTACK	28 [MSB]/ 60 [LSB]	0	0 - 127 [MSB] / 0 - 127 [LSB]	MIDI CC replaces the VCA ATTACK knob setting; moving this knob overrides the MIDI CC value.
VCA (EG) DECAY	29 [MSB]/ 61 [LSB]	0	0 - 127 [MSB] / 0 - 127 [LSB]	MIDI CC replaces the VCA DECAY knob setting; moving this knob overrides the MIDI CC value.

MIDI OPERATIONS *(Continued)*

Parameter	MIDI CC#	Default	Range	Remarks
Play (MIDI Transport)	SysEx	ON	OFF; ON	SysEx files can be found at www.moogmusic.com
Rhythm Generator Logic	113	0	0 - 63 OR / 64 - 127 XOR	OR logic advances the sequencer every time a clock is received from one or both Rhythm Generators. XOR logic only advances the sequencer when just a singular clock is true — if both Rhythm Generators are true, the sequencer will not advance.
MIDI Channel	SysEx	1	1 - 16, All	SysEx files can be found at www.moogmusic.com .

PRESETS

Your Subharmonic has a 100% analog signal path and, as a result, each unit has subtle sonic differences due to component tolerances that make it unique. Two different units set the same way may sound slightly different, which is normal. Due to Subharmonic's analog nature and mathematically derived functions, small derivations in knob placement can make a big impact on the sound of your patch. Use these presets as a starting point for your explorations and enjoy the journey!

AQUATIC CHORDS

SUBHARMONICON | SEMI-MODULAR ANALOG POLYRHYTHMIC SYNTHESIZER

AQUATIC CHORDS

NOTES:

Sequencer pitches are suggestions; adjust to taste.

MELLOW HARMONIES

SUBHARMONICON | SEMI-MODULAR ANALOG POLYRHYTHMIC SYNTHESIZER

MELLOW HARMONIES

NOTES:

Sequencer pitches are suggestions; adjust to taste.

Additional presets and blank patch sheets can be downloaded when you register your instrument at www.moogmusic.com.

SLIP & FALL

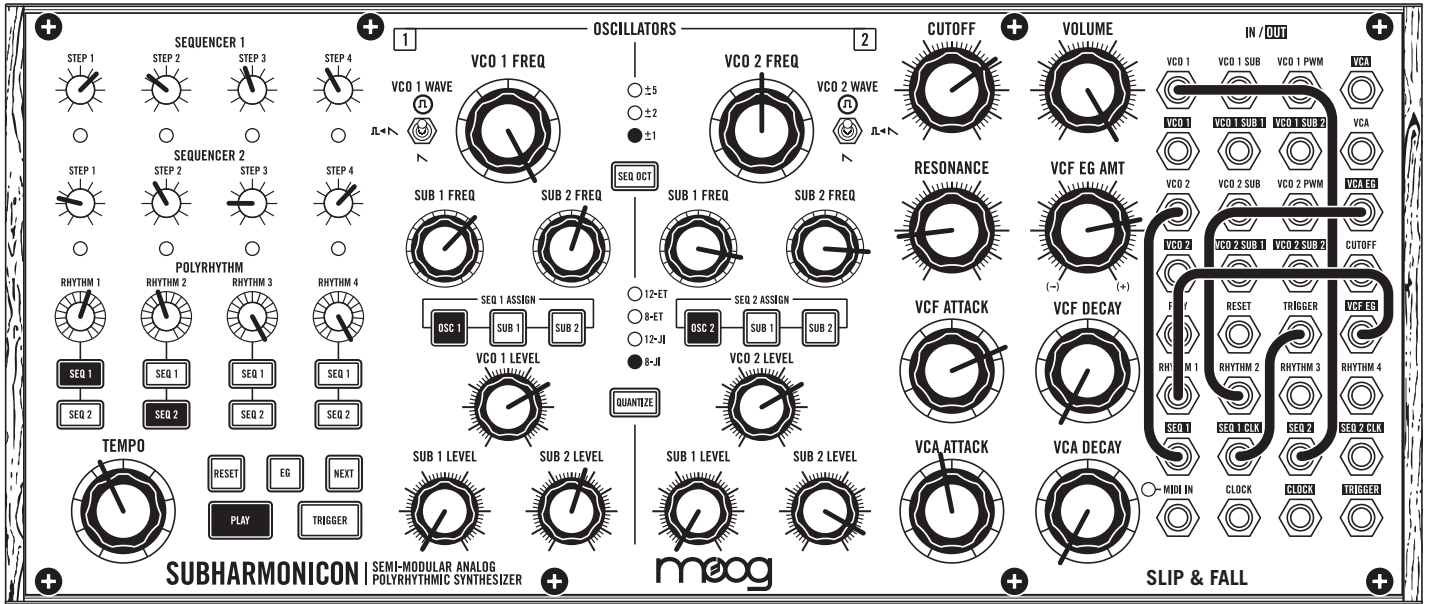

NOTES:

Sequencer pitches are suggestions; adjust to taste.

POINT ZERO

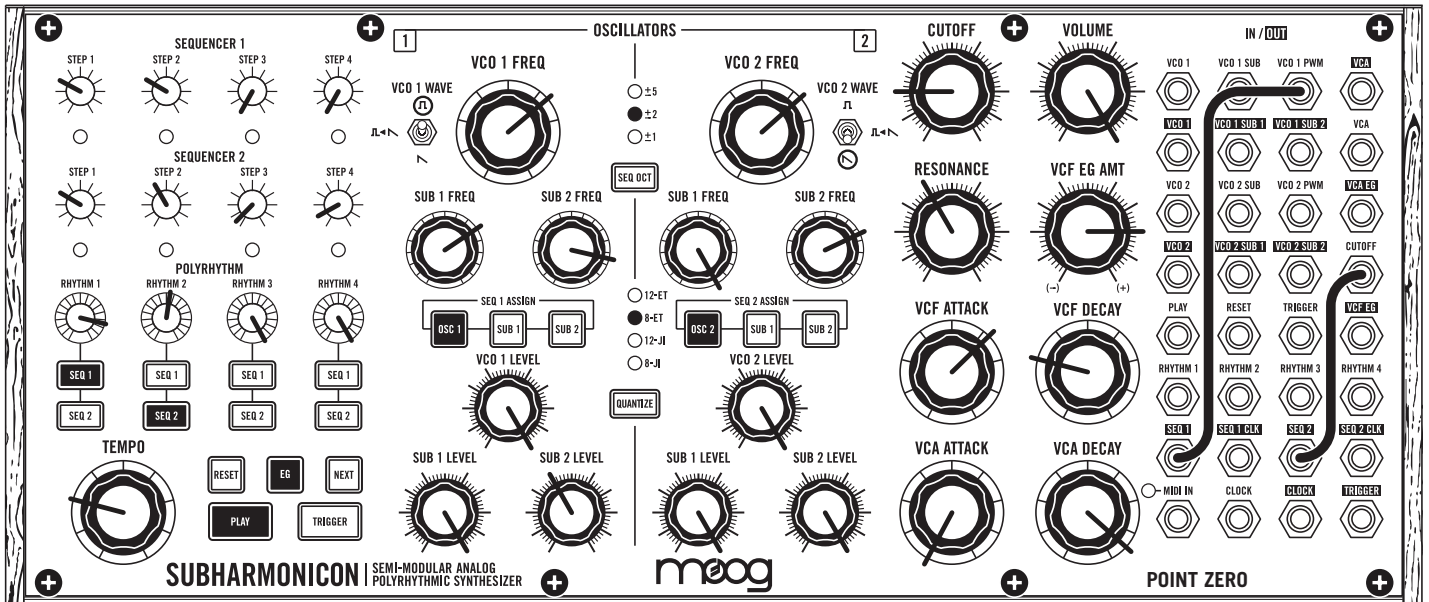

NOTES:

Tune **SEQ 1** and **SEQ 2** to desired pitches.
 Tune all Subharmonic Oscillators to desired interval.
 Adjust **VCF ATTACK** for length of filter sweep.

THREE HANDS ON THE WHEEL

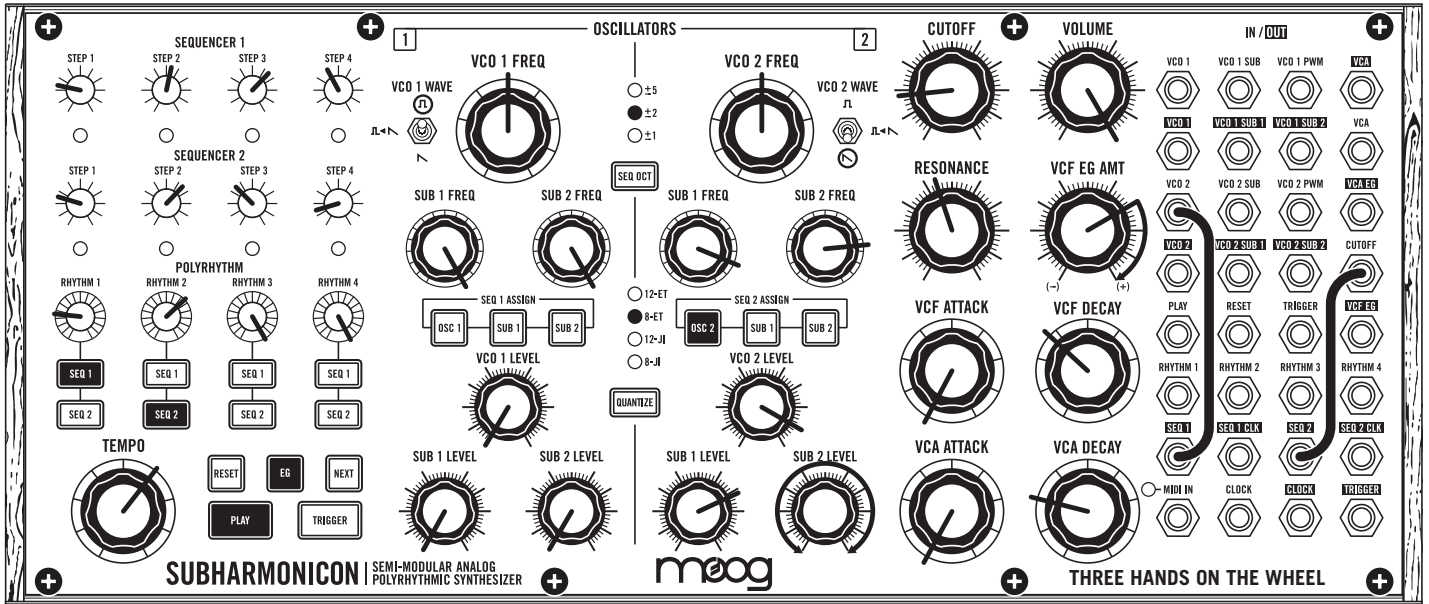

NOTES:

Sequencer pitches are suggestions; adjust to taste.

BATERIA

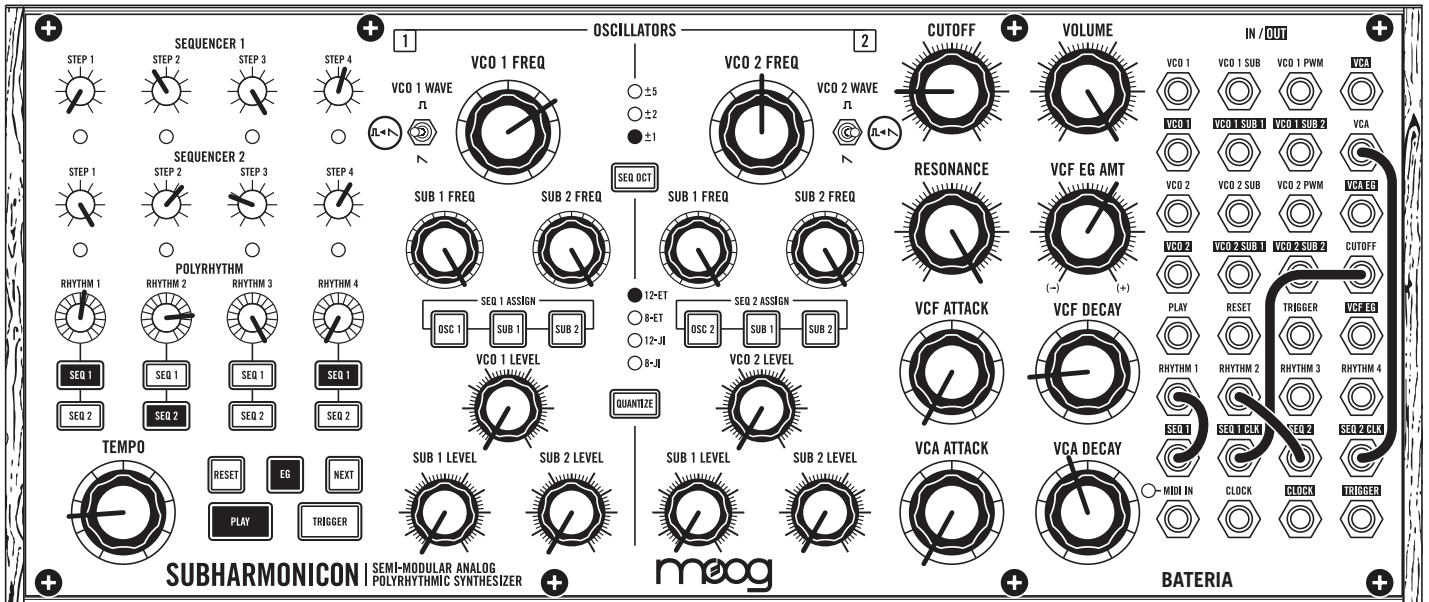

NOTES:

Kick drum tuning is controlled via filter **CUTOFF**.
Adjust **VCF DECAY** and **EG AMT** knobs for different kick drum flavors.

SPIRAL WAYS

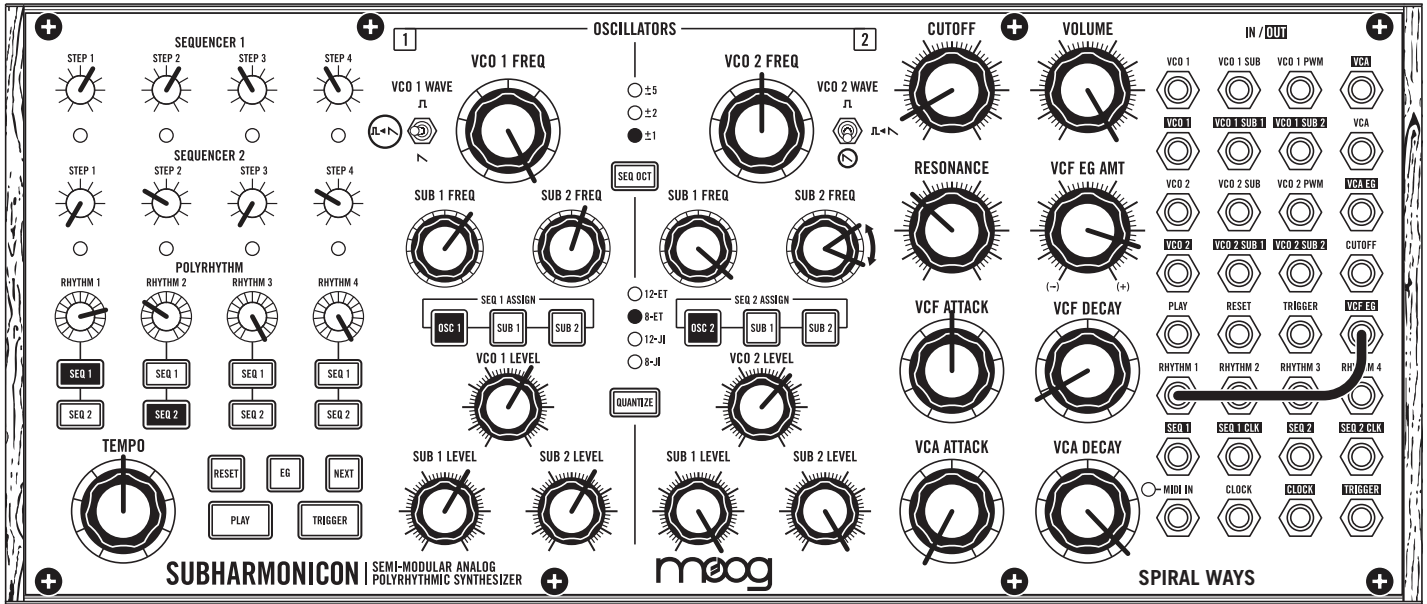

NOTES:

- Tune sequencers to desired pitches.
- Tune **SUB VCO 1 FREQ 1** to a Fifth. Tune **SUB VCO 2 SUB 2** to a Major 3rd.
- Adjust **VCF ATTACK** for crescendo depth.

STAR-GATE

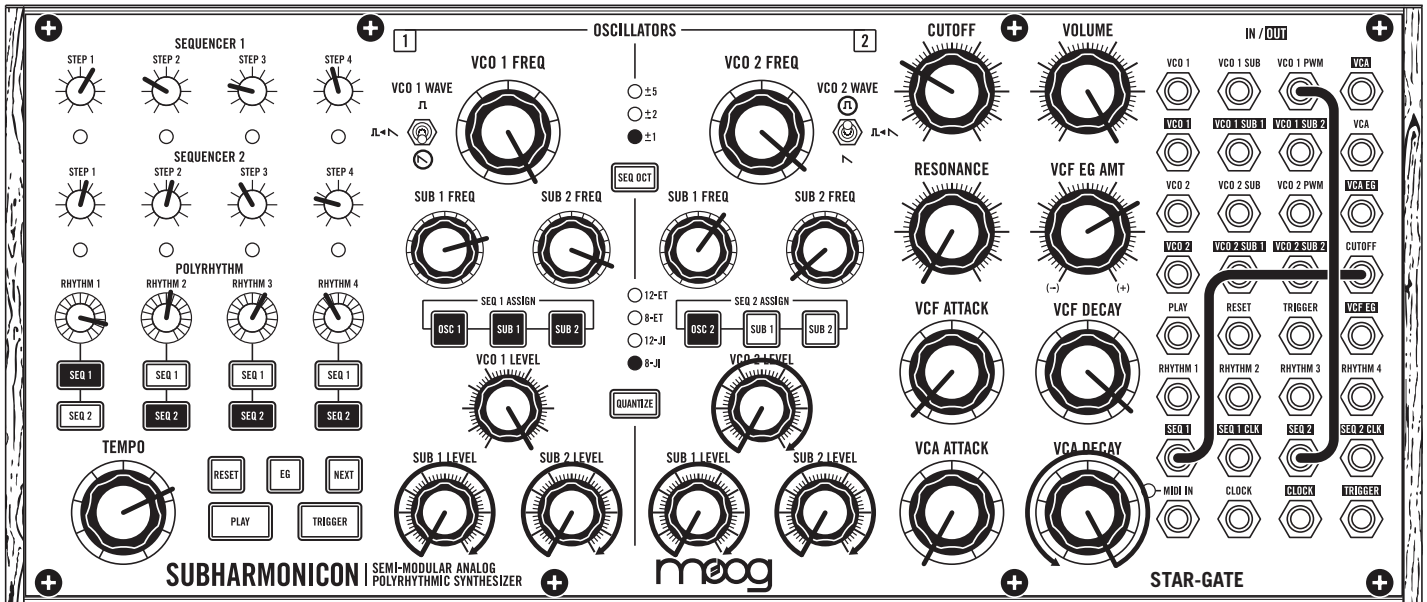

NOTES:

- Tune **SEQ 1** and **SEQ 2** to desired hi-octave pitches.
- For percolating clusters, adjust the **RHYTHM 2**, **RHYTHM 3**, and **RHYTHM 4 SEQ 2** knob rates.
- Adjust **VCA DECAY** for unique universal rhythmic clusters.
- Reset and play sequence; perform on all mixer dials to bring different pitches in and out of the cosmic void.

POLY ROCK

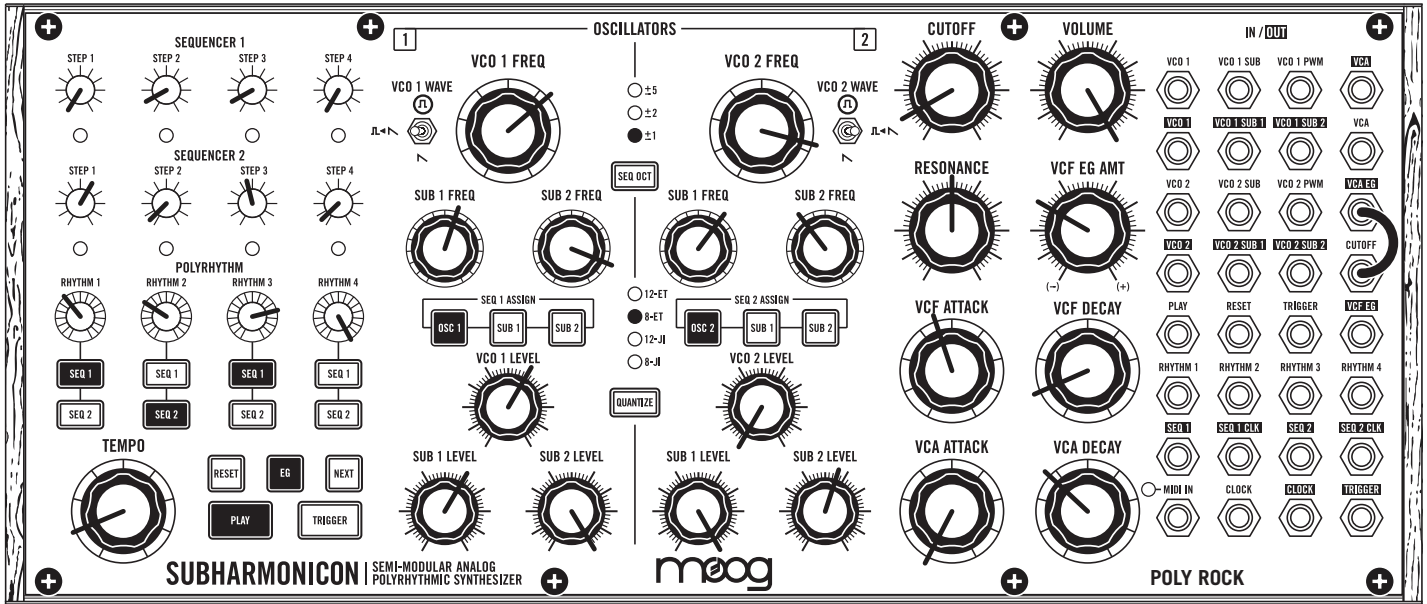

NOTES:

- Tune **SEQ 1** and **SEQ 2** to desired pitches.
- Tune **SUB OSC 1, 2, 3,** and **4** to desired chord shapes.
- Patch **CLOCK OUT** to **VCA IN** for “drums.”

CLOUD PATH

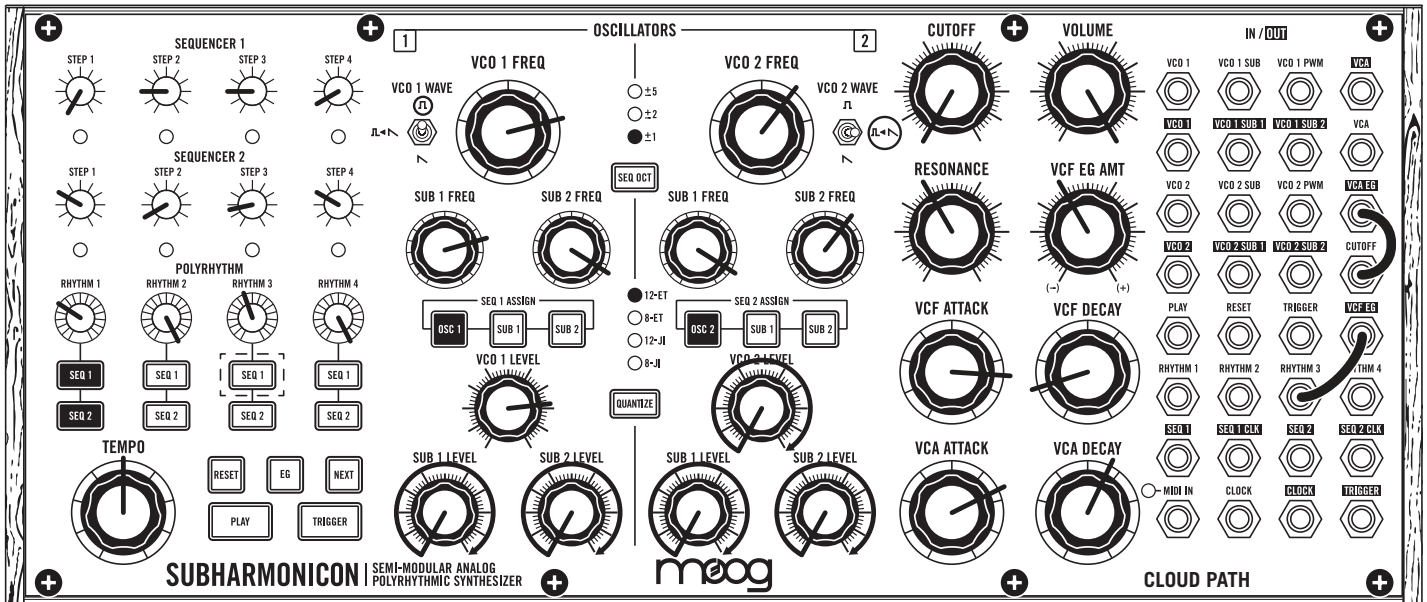

NOTES:

- Open **VCO 1 LEVEL** first.
- Tune **SEQ 1**. Open **VCO 2 LEVEL**. Tune **SEQ 2**. Turn volume back down.
- Repeat tuning for all **SUB OSC**; tune to desired intervals. Turn volume to zero.
- Reset and play sequence. Slowly increase volumes of **VCO 2 LEVEL** and then all Sub levels.
- Press **RHYTHM 3 SEQ 1** for double-time feels (indicated by dotted line).

PRESET NAME:

The image shows the front panel of a Moog SUBHARMONICON synthesizer. It features a variety of controls for two oscillators and two sequencers. On the left, there are two sequencers, each with four steps and two rhythm patterns. Below them are tempo controls and buttons for RESET, EG, NEXT, PLAY, and TRIGGER. The center section contains two oscillators, each with VCO 1 and VCO 2 frequency knobs, waveforms, and sub-frequency/level controls. The right side is dominated by filter and envelope parameters, including CUTOFF, VOLUME, RESONANCE, VCF EG AMT, VCF ATTACK, VCF DECAY, VCA ATTACK, and VCA DECAY. A large IN/OUT section on the far right includes buttons for VCA, VCO 1, VCO 2, and various filter and envelope parameters. The Moog logo and the text 'SUBHARMONICON | SEMI-MODULAR ANALOG POLYRHYTHMIC SYNTHESIZER' are at the bottom.

NOTES:

PRESET NAME:

This image is an identical copy of the Moog SUBHARMONICON synthesizer panel shown above. It displays the same layout of knobs, buttons, and sequencers, including the Moog logo and the text 'SUBHARMONICON | SEMI-MODULAR ANALOG POLYRHYTHMIC SYNTHESIZER' at the bottom.

NOTES:

PRESET NAME:

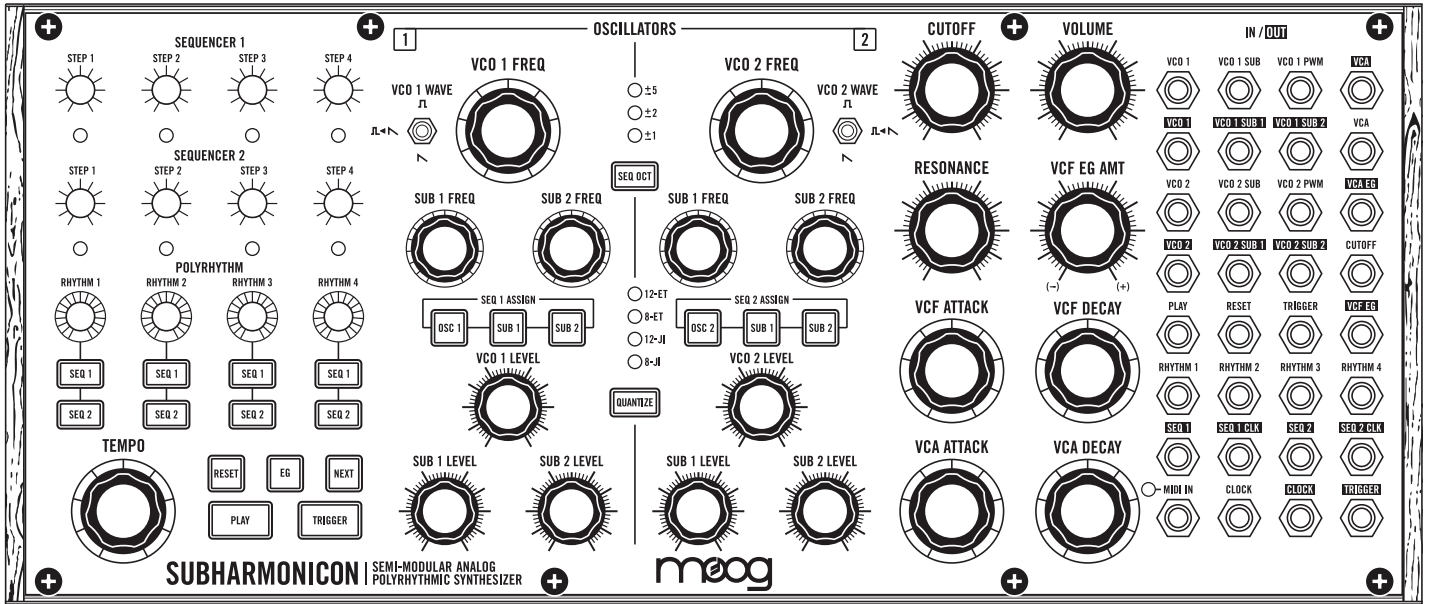

NOTES:

PRESET NAME:

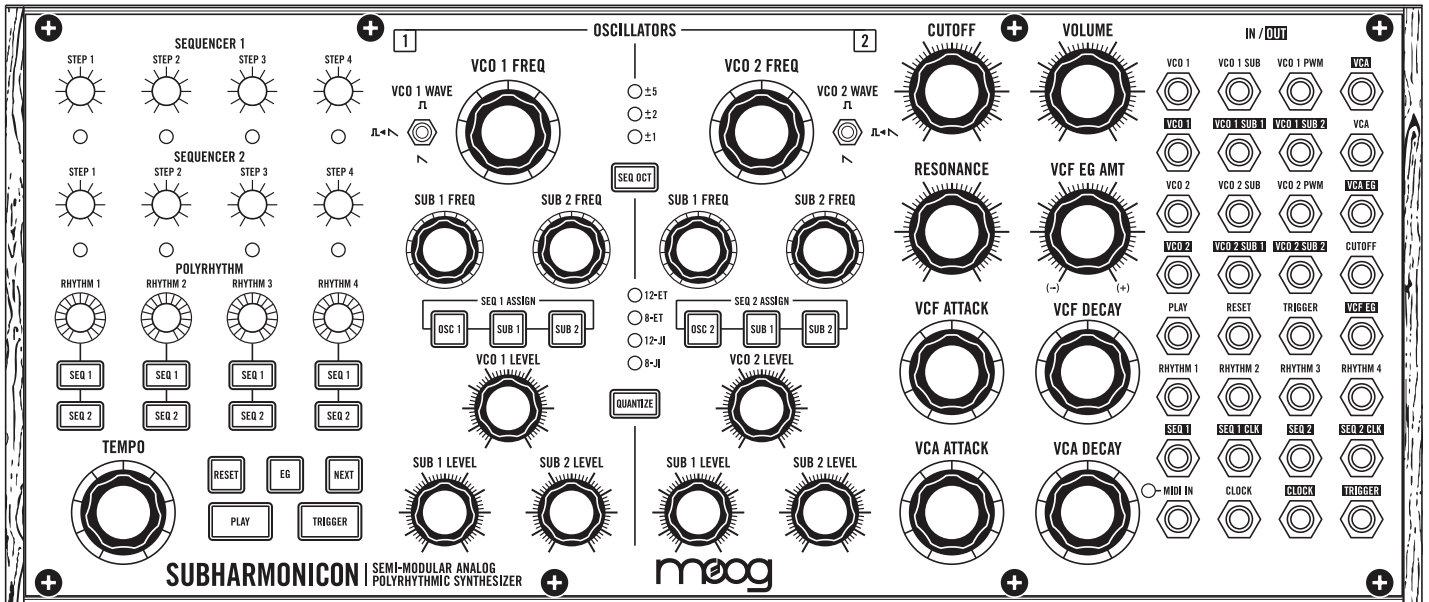

NOTES:

PRESET NAME:

The image shows the control panel of a Mog SUBHARMICON synthesizer. It is divided into several functional sections:

- SEQUENCER 1 & 2:** Each has four steps (STEP 1-4) with sunburst-style knobs and a 'TRIGGER' button.
- POLYRHYTHM:** Four rhythm patterns (RHYTHM 1-4) with sunburst knobs and 'SEQ 1'/'SEQ 2' buttons.
- TEMPO:** A large sunburst knob and 'RESET', 'EG', 'NEXT', 'PLAY', and 'TRIGGER' buttons.
- OSCILLATORS:** Two main oscillators (VCO 1 & 2) with 'WAVE' selectors and 'FREQ' knobs. Each has two sub-oscillators (SUB 1 & 2) with 'FREQ' knobs and 'LEVEL' knobs. Includes 'SEQ OCT', 'OSC ASSIGN', and 'QUANTIZE' options.
- FILTERS:** 'CUTOFF', 'RESONANCE', 'VCF ATTACK', 'VCF DECAY', 'VCA ATTACK', and 'VCA DECAY' knobs.
- VOLUME:** A large sunburst knob.
- IN / OUT:** A grid of 16 hexagonal buttons for routing signals between various modules.

At the bottom, it reads 'SUBHARMICON | SEMI-MODULAR ANALOG POLYRHYTHMIC SYNTHESIZER' and the 'mog' logo.

NOTES:

PRESET NAME:

This image is an identical copy of the Mog SUBHARMICON synthesizer panel shown above, featuring the same layout of sequencers, oscillators, filters, and routing options.

NOTES:

PRESET NAME:

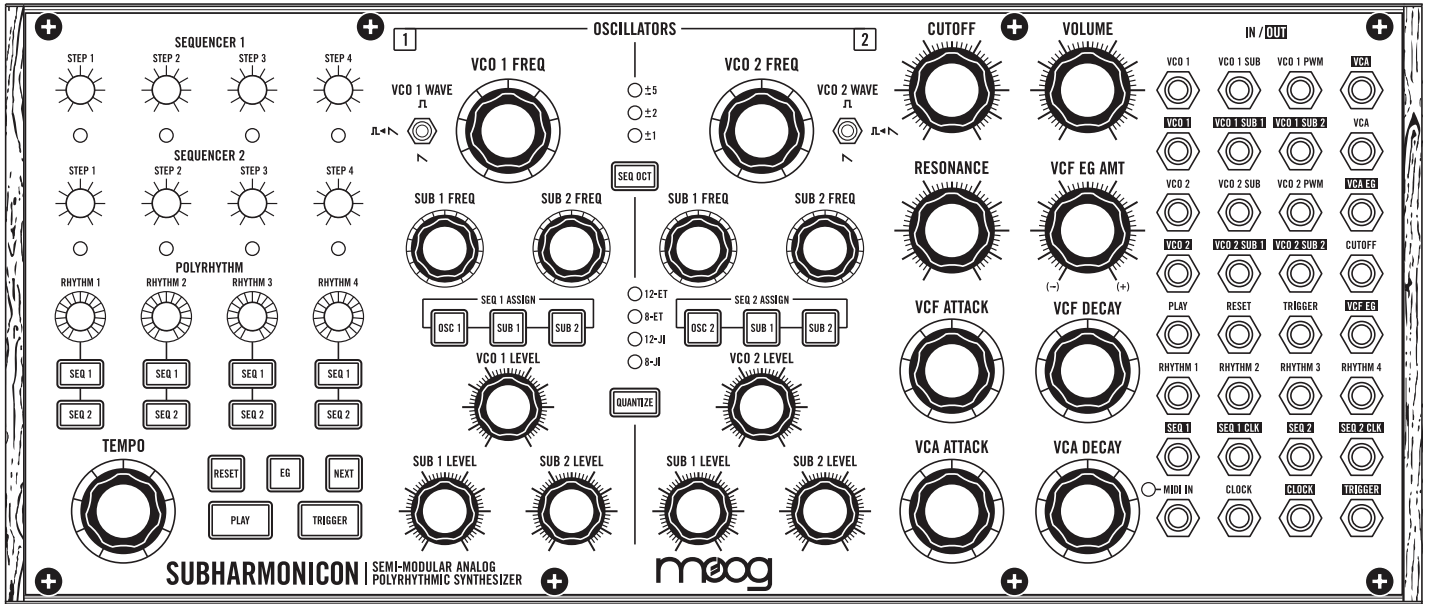

NOTES:

PRESET NAME:

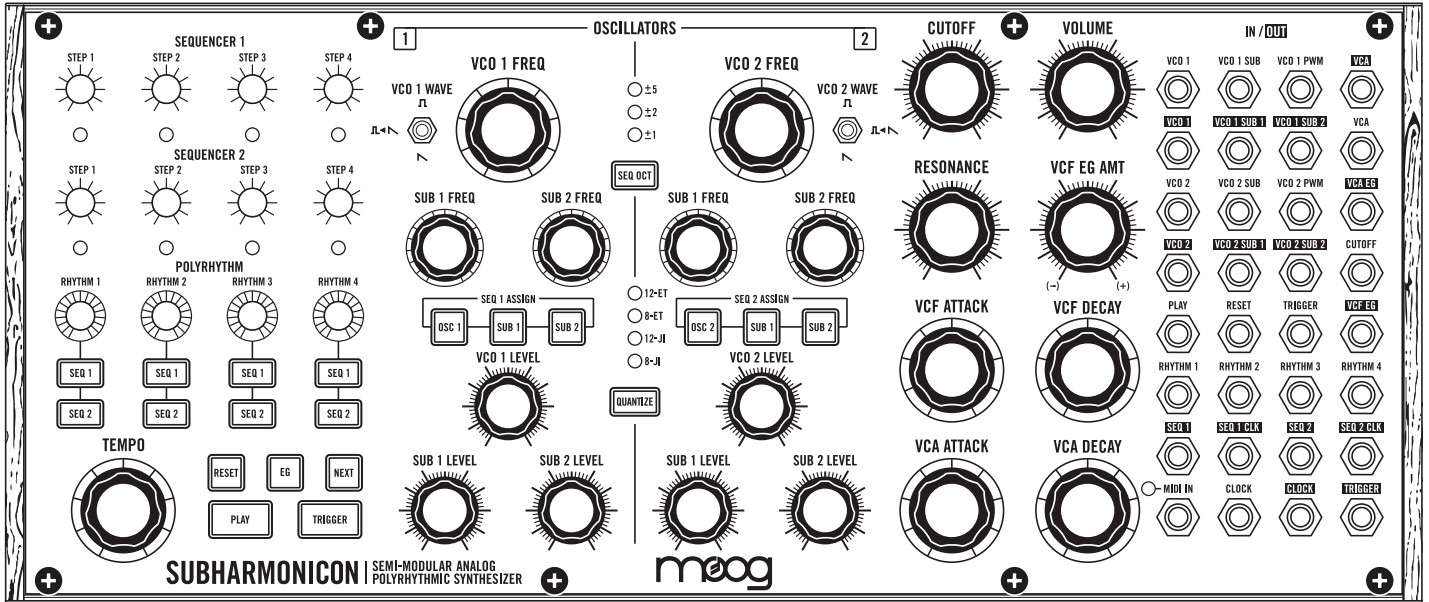

NOTES:

PRESET NAME:

The control panel features several sections:

- SEQUENCER 1 & 2:** Each has four steps (STEP 1-4) with sunburst knobs and a RHYTHM section with four rhythm knobs and two sequence knobs (SEQ 1, SEQ 2).
- POLYRHYTHM:** Four rhythm knobs and two sequence knobs.
- TEMPO:** A large sunburst knob and buttons for RESET, EG, NEXT, PLAY, and TRIGGER.
- OSCILLATORS:** Two main oscillators (VCO 1 and VCO 2) with waveforms, frequency knobs, and sub-oscillators (SUB 1 and SUB 2) with frequency and level knobs. Includes a SEQ OCT selector and a QUANTIZE button.
- FILTERS:** CUTOFF, RESONANCE, VCF ATTACK, VCF DECAY, VCA ATTACK, and VCA DECAY knobs.
- VOLUME:** A large sunburst knob.
- IN / OUT:** A grid of 16 hexagonal buttons for routing signals between VCOs, VCFs, and VCAs.

SUBHARMONICON | SEMI-MODULAR ANALOG POLYRHYTHMIC SYNTHESIZER | **moog**

NOTES:

PRESET NAME:

The control panel features several sections:

- SEQUENCER 1 & 2:** Each has four steps (STEP 1-4) with sunburst knobs and a RHYTHM section with four rhythm knobs and two sequence knobs (SEQ 1, SEQ 2).
- POLYRHYTHM:** Four rhythm knobs and two sequence knobs.
- TEMPO:** A large sunburst knob and buttons for RESET, EG, NEXT, PLAY, and TRIGGER.
- OSCILLATORS:** Two main oscillators (VCO 1 and VCO 2) with waveforms, frequency knobs, and sub-oscillators (SUB 1 and SUB 2) with frequency and level knobs. Includes a SEQ OCT selector and a QUANTIZE button.
- FILTERS:** CUTOFF, RESONANCE, VCF ATTACK, VCF DECAY, VCA ATTACK, and VCA DECAY knobs.
- VOLUME:** A large sunburst knob.
- IN / OUT:** A grid of 16 hexagonal buttons for routing signals between VCOs, VCFs, and VCAs.

SUBHARMONICON | SEMI-MODULAR ANALOG POLYRHYTHMIC SYNTHESIZER | **moog**

NOTES:

PRESET NAME:

SEQUENCER 1
STEP 1 STEP 2 STEP 3 STEP 4
STEP 1 STEP 2 STEP 3 STEP 4
POLYRHYTHM
RHYTHM 1 RHYTHM 2 RHYTHM 3 RHYTHM 4
SEQ 1 SEQ 2
SEQ 1 SEQ 2
SEQ 1 SEQ 2
SEQ 1 SEQ 2
TEMPO
RESET EG NEXT
PLAY TRIGGER

OSCILLATORS
VCO 1 FREQ VCO 2 FREQ
VCO 1 WAVE VCO 2 WAVE
SUB 1 FREQ SUB 2 FREQ
SUB 1 FREQ SUB 2 FREQ
SUB 1 FREQ SUB 2 FREQ
SUB 1 FREQ SUB 2 FREQ
VCO 1 LEVEL VCO 2 LEVEL
SUB 1 LEVEL SUB 2 LEVEL
SUB 1 LEVEL SUB 2 LEVEL
SUB 1 LEVEL SUB 2 LEVEL

CUTOFF VOLUME
RESONANCE VCF EG AMT
VCF ATTACK VCF DECAY
VCA ATTACK VCA DECAY

IN / OUT
VCO 1 VCO 1 SUB VCO 1 PWM VCA
VCO 2 VCO 2 SUB VCO 2 PWM VCA
VCO 2 SUB 1 VCO 2 SUB 2 CUTOFF
PLAY RESET TRIGGER VCF EG
RHYTHM 1 RHYTHM 2 RHYTHM 3 RHYTHM 4
SEQ 1 SEQ 1 CLK SEQ 2 SEQ 2 CLK
MIDI IN CLOCK BLOCK TRIGGER

SUBHARMICON | SEMI-MODULAR ANALOG POLYRHYTHMIC SYNTHESIZER
moog

NOTES:

PRESET NAME:

SEQUENCER 1
STEP 1 STEP 2 STEP 3 STEP 4
STEP 1 STEP 2 STEP 3 STEP 4
POLYRHYTHM
RHYTHM 1 RHYTHM 2 RHYTHM 3 RHYTHM 4
SEQ 1 SEQ 2
SEQ 1 SEQ 2
SEQ 1 SEQ 2
SEQ 1 SEQ 2
TEMPO
RESET EG NEXT
PLAY TRIGGER

OSCILLATORS
VCO 1 FREQ VCO 2 FREQ
VCO 1 WAVE VCO 2 WAVE
SUB 1 FREQ SUB 2 FREQ
SUB 1 FREQ SUB 2 FREQ
SUB 1 FREQ SUB 2 FREQ
SUB 1 FREQ SUB 2 FREQ
VCO 1 LEVEL VCO 2 LEVEL
SUB 1 LEVEL SUB 2 LEVEL
SUB 1 LEVEL SUB 2 LEVEL
SUB 1 LEVEL SUB 2 LEVEL

CUTOFF VOLUME
RESONANCE VCF EG AMT
VCF ATTACK VCF DECAY
VCA ATTACK VCA DECAY

IN / OUT
VCO 1 VCO 1 SUB VCO 1 PWM VCA
VCO 2 VCO 2 SUB VCO 2 PWM VCA
VCO 2 SUB 1 VCO 2 SUB 2 CUTOFF
PLAY RESET TRIGGER VCF EG
RHYTHM 1 RHYTHM 2 RHYTHM 3 RHYTHM 4
SEQ 1 SEQ 1 CLK SEQ 2 SEQ 2 CLK
MIDI IN CLOCK BLOCK TRIGGER

SUBHARMICON | SEMI-MODULAR ANALOG POLYRHYTHMIC SYNTHESIZER
moog

NOTES:

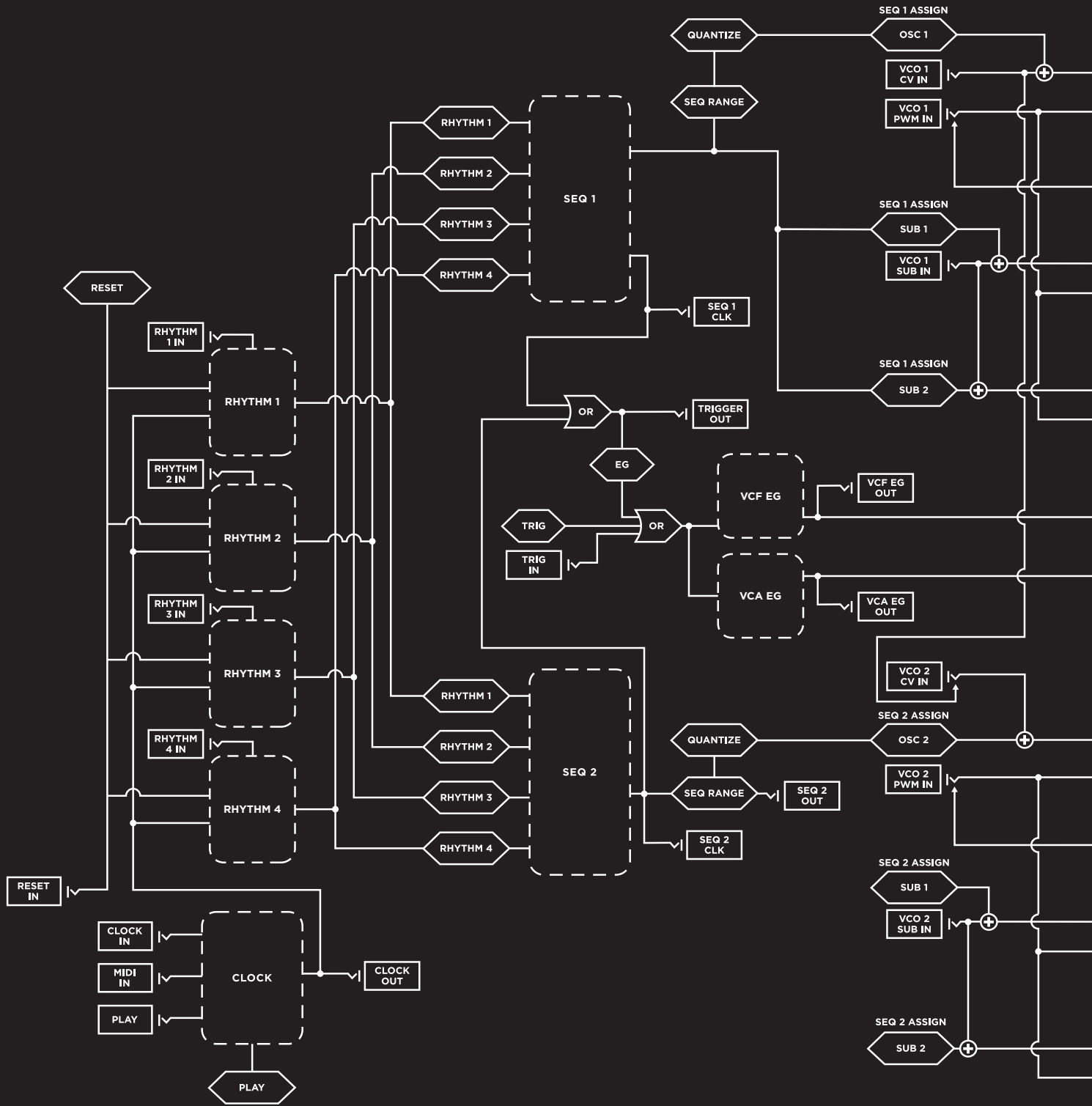

SIGNAL FLOW

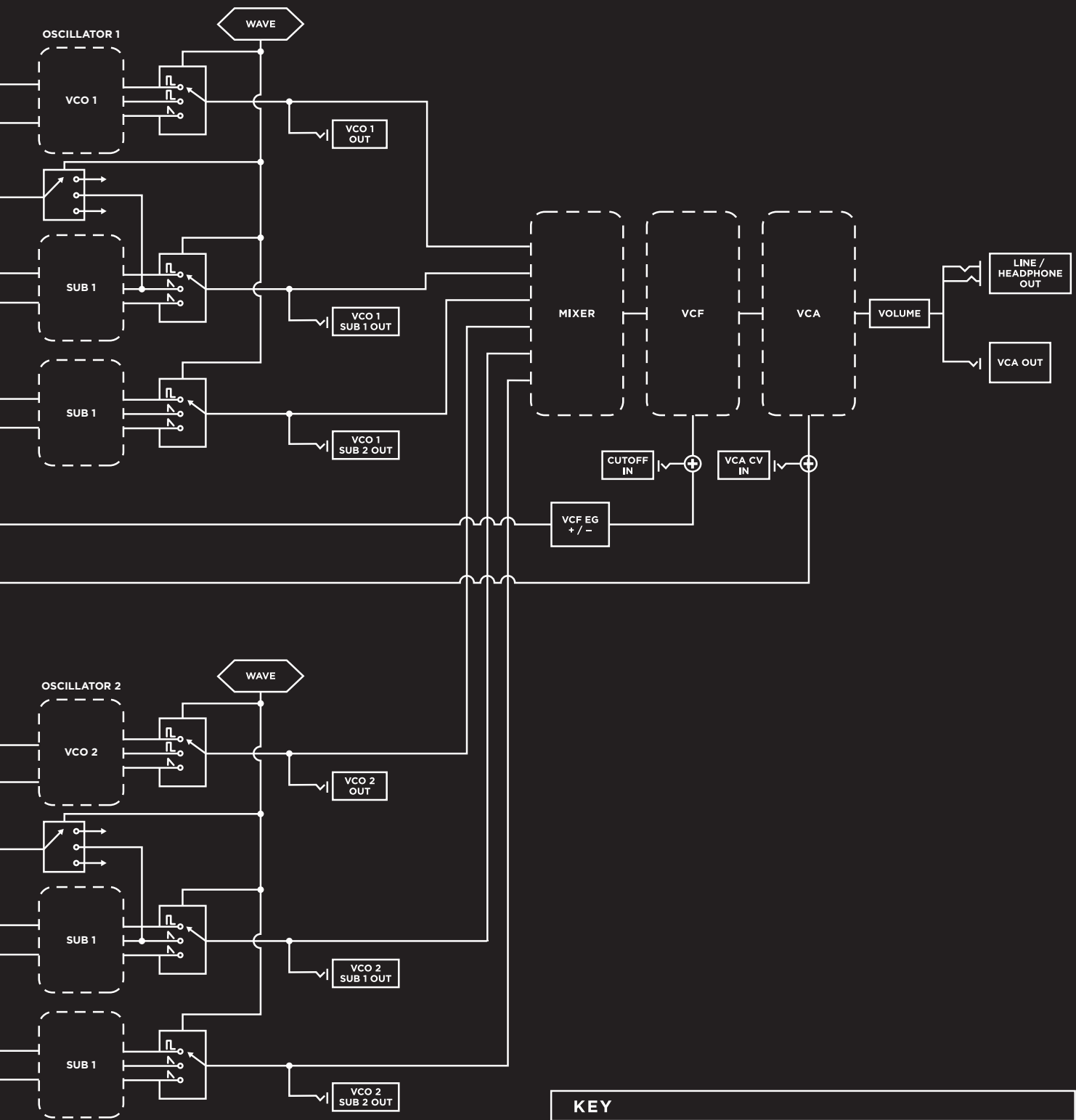

KEY			
	FRONT PANEL CONTROL		NOT CONNECTED
	MODULE		CONNECTION
	AMPLIFIER		SUMMING
			JACK
			NORMALLED JACK
			MODE

■ SPECIFICATIONS

ANALOG SOUND ENGINE

SOURCES: VCO 1, SUB 1, SUB 2 / VCO 2, SUB 1, SUB 2

FILTER: Self-Oscillating Ladder Filter, Low-Pass, 4-Pole (-24 dB/Octave)

ENVELOPES: VCA EG (Attack, Decay); VCF EG (Attack, Decay)

ANALOG SEQUENCERS (x2)

STEPS: 4 Steps per Sequencer, selectable Quantization

CLOCK: Driven by any and all of the Rhythm Generators

RHYTHM GENERATORS (x4)

RHYTHM: Derived by dividing the Tempo by an integer value (1-16)

CLOCK: 20 BPM to 3,000 BPM (Beats Per Minute; 1 Pulse Per Quarter-note), MIDI Clock, EXT CLOCK

PATCHBAY

JACKS: 32 x 3.5mm

INPUTS: 17 Input Jacks

OUTPUTS: 15 Output Jacks

REAR PANEL

AUDIO: 1/4" TRS Headphone or 1/4" TS Instrument

POWER: Power Supply connection

SECURITY: Kensington Lock slot

DIMENSIONS

SIZE (WxDxH): 12.57" x 4.21" x 5.24"

WEIGHT: 3.5 lbs

POWER SUPPLY (INCLUDED)

STYLE: Wall adapter; barrel connection; center-pin positive

INPUT: 100 - 240VAC; 50 Hz - 60 Hz

OUTPUT: +12VDC; 1200mA

POWER CONSUMPTION

TYPICAL: 4.8 Watts

EURORACK SPECS

CURRENT DRAW: 360mA (maximum) from +12VDC (10-pin header)

MOUNTING DIMS: 60HP (1"/26mm Module Depth)

ACCESSORIES

The following accessories are available for purchase at authorized Moog dealers:

2-TIER VERTICAL RACK KIT

3-TIER VERTICAL RACK KIT

GIG BAG

6" 3.5 mm CABLE PACK (QTY 5)

12" 3.5 mm CABLE PACK (QTY 5)

EMPTY 60HP CASE

EMPTY 104HP CASE

BACKUP POWER SUPPLY

■ SERVICE & SUPPORT INFORMATION

MOOG'S STANDARD WARRANTY

Moog warrants its products to be free of defects in materials or workmanship and conforming to specifications at the time of shipment. The Warranty Period is one year from the date of purchase. If, in Moog's determination, it has been more than five years since the product shipped from our factory, it will be at Moog's discretion whether or not to honor the warranty without regard to the date of the purchase. During the Warranty Period, any defective products will be repaired or replaced, at Moog's option, on a return-to-factory basis. This warranty covers defects that Moog determines are no fault of the user.

The Moog Limited Warranty applies to USA purchasers only. Outside the USA the warranty policy and associated service is determined by the laws of the country of purchase and supported by our local authorized distributor. A listing of our authorized distributors is available at www.moogmusic.com.

If you purchase outside of your country, you can expect to be charged for warranty as well as non-warranty service by the service center in your country.

RETURNING YOUR PRODUCT TO MOOG MUSIC

You must obtain prior approval in the form of an RMA (Return Material Authorization) number from Moog before returning any product. Email techsupport@moogmusic.com for the RMA number or call us at +1 (828) 251-0090. All products must be packed carefully and shipped with the Moog supplied power adapter. The Subharmonic must be returned in the original inner packing including the cardboard inserts. The warranty will not be honored if the product is not properly packed. Once you have received the RMA number and carefully packed your Moog Subharmonic, ship the product to Moog Music, Inc. with transportation and insurance charges paid, and be sure to include your return shipping address.

MOOG MUSIC, INC.
160 Broadway St.
Asheville, NC 28801

WHAT WE WILL DO

Once received, we will examine the product for any obvious signs of user abuse or damage as a result of transport. If the product was abused, was damaged in transit, or is out of warranty, we will contact you with an estimate of the repair cost. If warranty work is performed, Moog will ship and insure your product to your United States address free of charge.

HOW TO INITIATE YOUR WARRANTY

Please initiate your warranty online at www.moogmusic.com/register. If you do not have web access, please call (828) 251-0090 to register your product.

CARING FOR SUBHARMONICON

Clean Subharmonic with a soft, dry cloth only – do not use solvents or abrasive detergents. Heed the safety warnings at the beginning of the manual. Do not drop the unit.

AN IMPORTANT NOTE ABOUT SAFETY: *There are no user serviceable parts in Subharmonic. Refer all servicing to qualified personnel only.*

©2020 Moog Music, Inc. All rights reserved. Moog, Moog (stylized with design), and the Moog logo are trademarks of Moog Music, Inc. Registered in U.S. Patent and Trademark Office and elsewhere. Subharmonic is a trademark of Moog Music, Inc. in the United States and elsewhere.

Subharmonic User Manual Version 1

For the most up-to-date user manual and firmware updates, visit www.moogmusic.com/subharmonic.

Phone: +1 (828) 251-0090 | Email: info@moogmusic.com | Website: www.moogmusic.com

