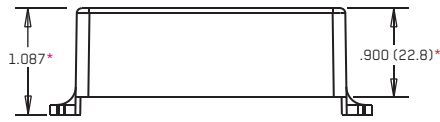




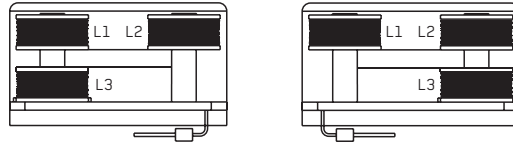
0230-0369-B

PO BOX 4394  
SANTA ROSA, CA  
95402 USA

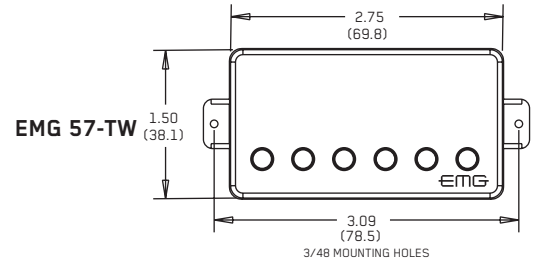
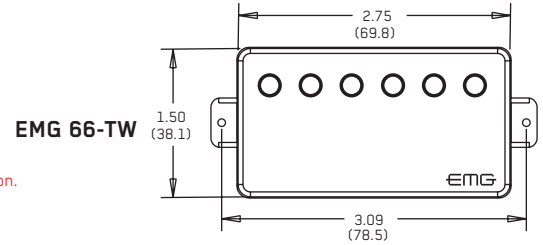
P (707) 525-9941  
F (707) 575-7046  
EMGPICKUPS.COM



\* The TW is taller than the typical EMG Pickup,  
Be sure to it will fit in your guitar before you start the installation.



In Dual-coil mode, coils L1 and L2 are active.  
The 57-TW in Single-coil mode, coils L2 and L3 are active.  
The 66-TW in Single-coil mode, coils L1 and L3 are active..



## INSTALLATION INFORMATION

### EMG MODELS: 57-TW/66-TW SET

#### SPECIFICATIONS:

|                           | MODEL: | Single-Coil | Dual-Coil | 66-TW<br>Copper<br>A/C | Single-Coil | Dual-Coil |
|---------------------------|--------|-------------|-----------|------------------------|-------------|-----------|
| Logo Color                | 57-TW  |             |           |                        |             |           |
| Magnet Type*              | Copper |             |           |                        |             |           |
| Resonant Frequency (KHz)  | A/S    | 3.47        | 1.77      |                        | 3.47        | 1.77      |
| Output Voltage (String)   |        | 2.00        | 3.00      |                        | 2.00        | 3.00      |
| Output Voltage (Strum)    |        | 3.00        | 4.50      |                        | 3.00        | 4.50      |
| Output Noise (60 Hz)      |        | -107        | -107      |                        | -107        | -107      |
| Output Impedance (Kohm)   |        | 10          | 10        |                        | 10          | 10        |
| Current (@9V (Microamps)  | 160    |             |           |                        |             |           |
| Battery Life (Hours)      | 1500   |             |           |                        |             |           |
| Maximum Supply (Volts DC) | 27     |             |           |                        |             |           |

\*Note: Magnet Type: A (Alnico) A/S (Alnico/Steel) C (Ceramic) C/S (Ceramic/Steel)

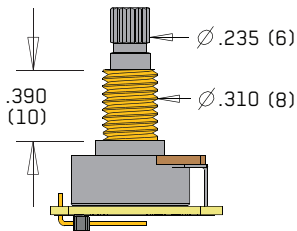
\*\*Note: Logo Colors are not distinguished on the Metalworks Sets

#### INSTALLATION NOTES:

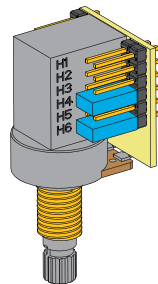
All EMG Pickups are compatible with each other. EMG accessories, the VLPF, EXG, SPC or RPC Controls can be added to any EMG Pickup System without requiring an extra battery. DO NOT reconnect the bridge ground wire, EMG Pickups do not require string grounding. Use the 25K Ohm controls that are included for best results. If your output jack is a long panel style you will need a stereo jack, use a SwitchCraft 152B, soldering will be required (see the bottom of page 2). Adjust the pickup level to the strings, and at a distance that works for you, experiment. Alternate wiring diagrams are available at; emgpickups.com.

#### INCLUDED IN THE SYSTEM:

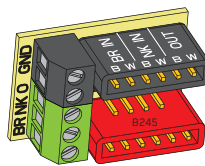
2 TONE CONTROLS (25K)



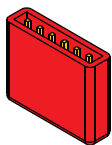
2 TW P/P SWITCH  
W/POT (25K)



2 PICKUP IN/ OUT  
BATTERY BUSS



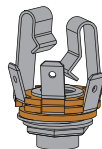
BATTERY  
BUSS



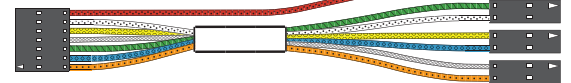
ADJUSTMENT  
SCREWS & SPRINGS (2 pr)



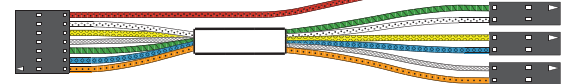
STEREO OUTPUT  
JACK



TW PICKUP CABLE 16" (40.64cm)



TW PICKUP CABLE 11" (27.94cm)



4 CONNECT CABLES 5.5" (14cm)



OUTPUT CABLE 6" (15cm)



BATTERY CABLE 7" (18cm)



#### WARRANTY

All EMG Pickups and accessories are warranted for a period of two years. This warranty does not cover failure due to improper installation, abuse or damage. If upon examination the pickup is determined to be defective, a replacement will be made. Warranty replacement products are covered by this same warranty. This warranty covers only those pickups and accessories sold by authorized EMG Dealers. This warranty is not transferable.

**General Notes:**

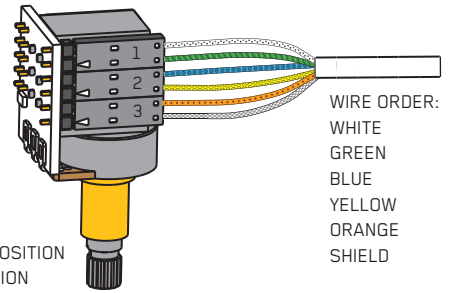
- Every attempt has been made to make this a solderless installation. There are some instances where this is not possible;
- 1) If your instrument uses the long panel output jack and you had passive pickups you will need a new stereo output jack, the Switchcraft 152B is recommended. Soldering to the new jack will be required.
  - 2) Some instruments may already have a battery holder installed, in that case soldering may be required.
  - 3) Instruments with two pickups may need soldering to the selection switch in some installations.

**Using the TW Push-Pull Switch**

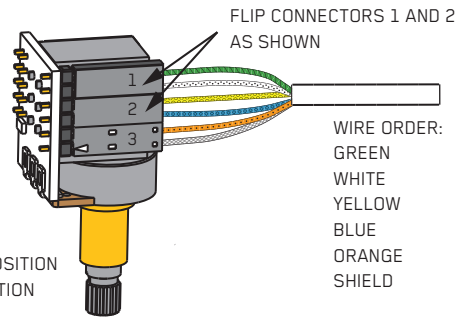
The Push-Pull Switch included with the TW Pickup allows you to choose between two internal pickups of the EMG-TW, single-coil and dual-coil. The Push-Pull Pot has two separate sections: The Switch and the pot, described below.

Refer to Diagrams #1 and #2

The Push-Pull Switch section (DPDT) lets you choose between the single-coil sound and a dual-coil sound by pulling or pushing the pot shaft up or down. You have the option of having the single-coil sound in either the up or down position and vice-versa for the dual-coil sound. Diagrams #1 and #2 show how to connect the TW Pickup cable to choose either option. Select the diagram that suits you and push the cable connectors onto the single line 6-pin header. Simply turn over cable connectors 1 and 2 to change the wire order and this will choose between the two options. Connector 3 remains the same for either choice.

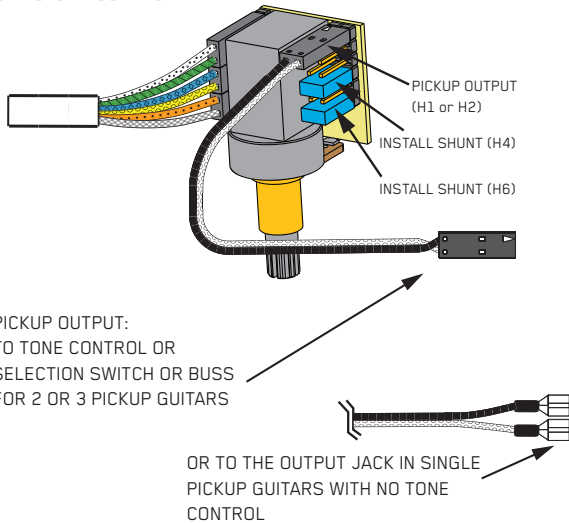


**Diagram #1**  
HUMBUCKING ON: DOWN POSITION  
SINGLE COIL ON: UP POSITION



**Diagram #2**  
SINGLE-COIL ON: DOWN POSITION  
HUMBUCKING ON: UP POSITION

**Diagram #3**  
PUSH / PULL POT USED AS  
THE PICKUP VOLUME CONTROL



**Using the TW Push-Pull Pot Section**

The Push-Pull Pot side of the EMG-TW allows you 4 different options:

- 1) Use the pot as a Master Volume for the Instrument
- 2) Use the pot as a Volume control for the TW Pickup
- 3) Use the pot as a Master Tone control for the Instrument
- 4) Use the pot as a Tone control for the TW pickup

On the PC Board there is a dual-line header with 6 pairs of pins. They are listed on the PC Board as H1 through H6. By using the the connections shown in Diagrams #3 through #6, you can choose any of the 4 options.

**Using the Pot Section as:**

**1) The Pickup Volume control, or a Master Volume for the Instrument. Refer to Diagrams #3 and #4**

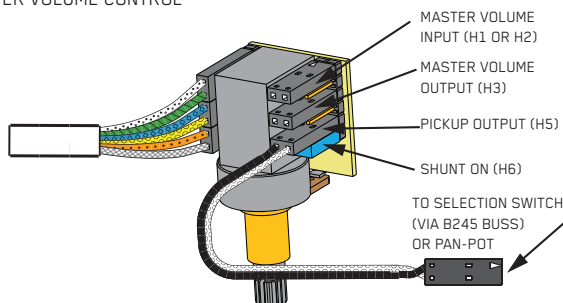
The pot section (25KA) can be used either as a Volume control for the pickup or, it can be used as the Master Volume for the guitar. Diagrams #3 and #4 show how to connect either option. Use the dual-line 12-pin header and push the cables on and install the shunts as needed onto the labeled headers H1 thru H6.

Use Diagram #3 if you have a single TW installed in your instrument, or have two or more pickups in your instrument and want to use the pot as the Volume control for the TW Pickup only.

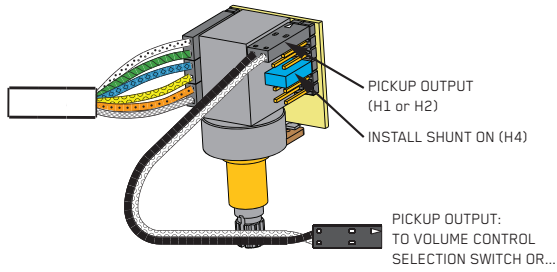
Installing the shunts on positions H4 and H6 sends the pickup signal to the wiper of the 25K Pot, and the output of the 25K Pot is at position H1 or H2.

Diagram #4 allows you to use the 25K Pot independently of the pickup output. By taking the output of the pickup from position H5, the Volume control is now available to use as a Master Volume with H1 or H2 being the input to the Volume control. H1 and H2 positions are interchangeable. Position H5, now the output of the pickup, would typically go to a selection switch or a pan-pot. Don't forget to install the shunt on H6.

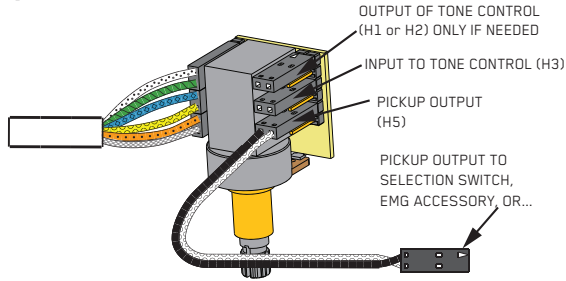
**Diagram #4**  
PUSH / PULL POT USED AS  
THE MASTER VOLUME CONTROL



**Diagram #5**  
PP POT USED AS THE PICKUP  
TONE CONTROL



**Diagram #6**  
PUSH-PULL POT USED AS A MASTER  
TONE CONTROL



Using the Pot Section as:  
**2) The Pickup Tone control or as a Master Tone control for the instrument.**  
Refer to Diagrams #5 and #6

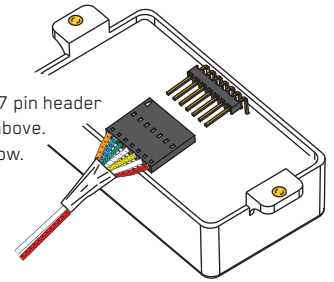
The pot section (25KA) can be used either as a Tone control for the pickup or it can be used as a Master Tone control for the guitar. Diagrams #5 and #6 show how to connect either option. Use the dual-line header, push the cables on and install the shunts as needed onto headers H1 thru H6.

Use Diagram #5 if you have a single 57-TW installed in your instrument, or have two or more pickups in your instrument and want to use the pot as the Tone control for the 57-TW Pickup only. Installing the shunt on position H4 connects a tone capacitor on the PC Board to the wiper of the 25K Pot and creates a passive Tone control. The output of pickup can be either position H1 or H2.

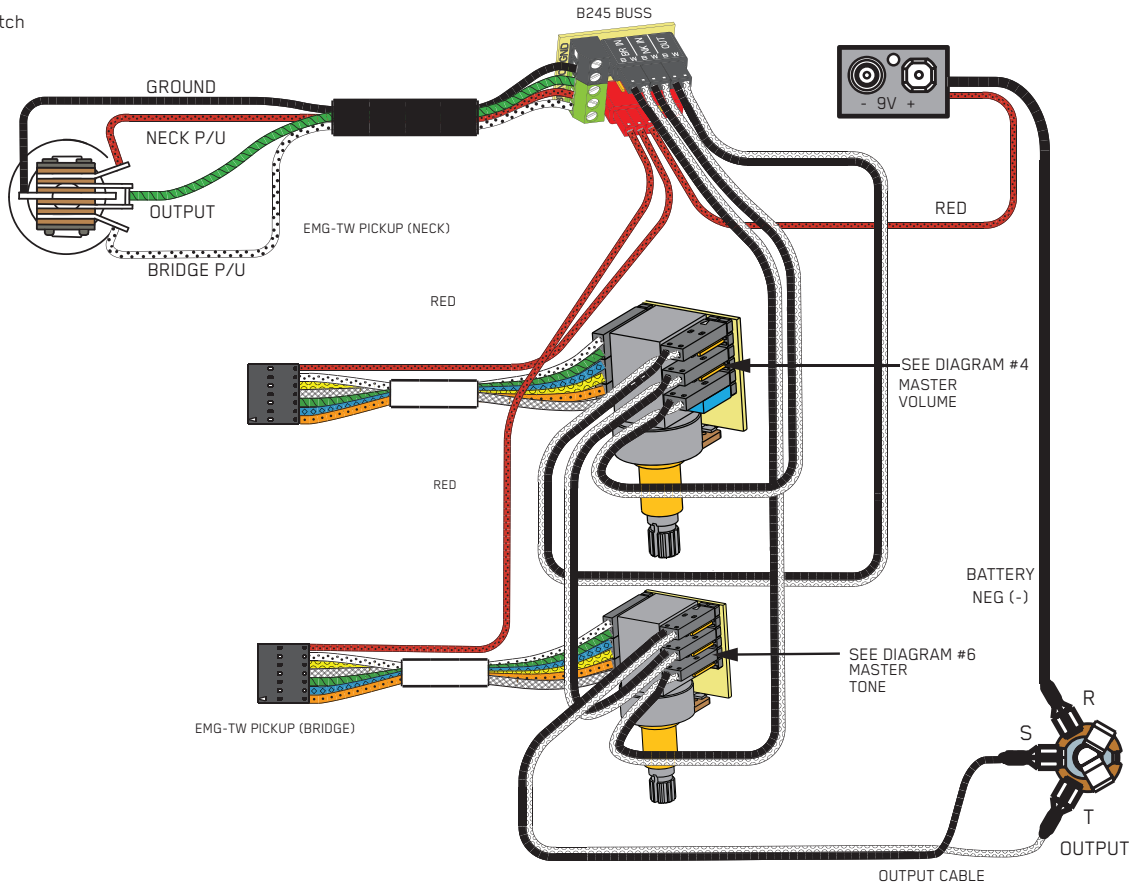
Diagram #6 uses the 25K Tone control independently of the pickup output. By taking the output of the pickup from Position H5, the control is now available to use as a Tone Control independent of the pickup output. Position H3 is the input to the Tone Control, with H1 or H2 being the output of the control, if necessary. Position H5, the output of the pickup, would typically go to a selection switch or output jack.

**Diagram #7**

Insert the plug onto the 7 pin header of the pickup as shown above. Note the orientation arrow.

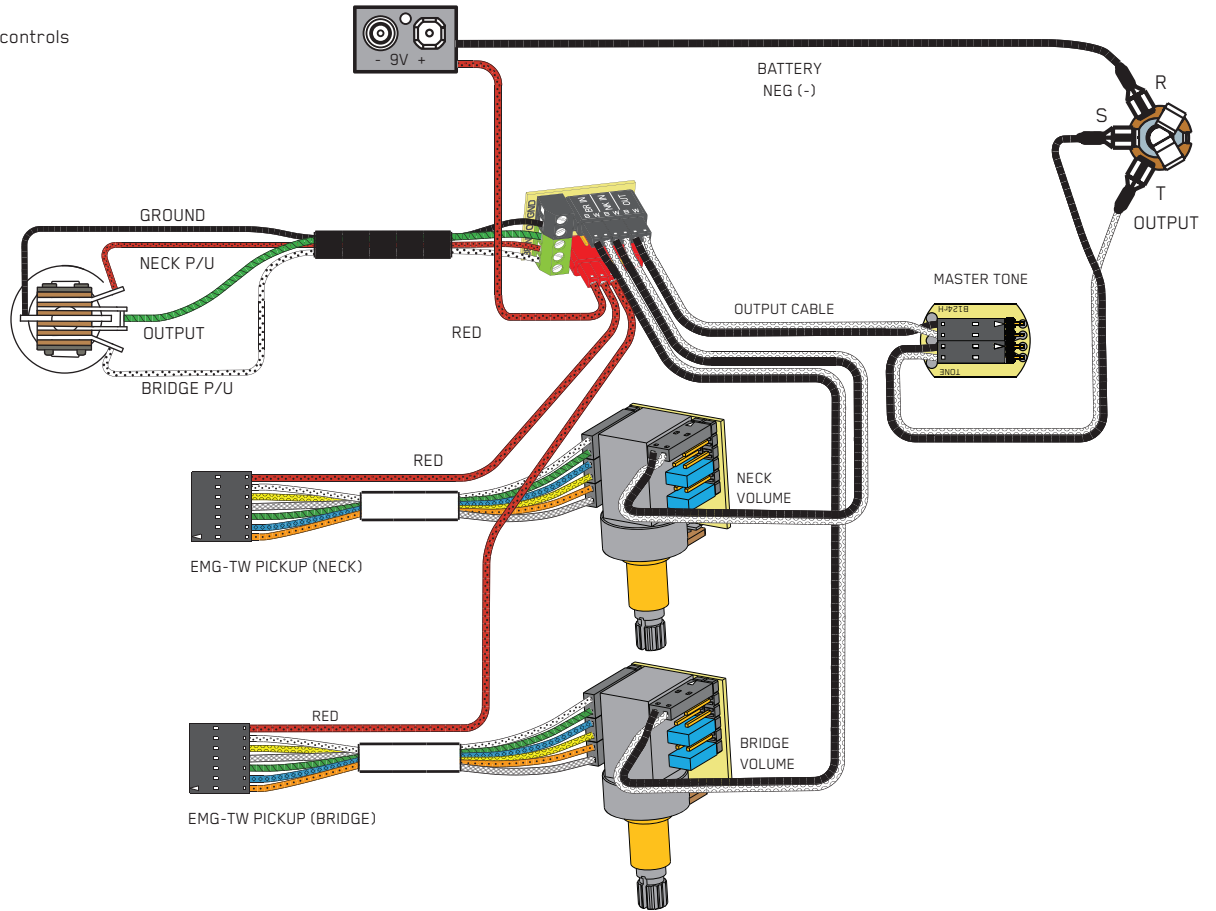


**Diagram #8**  
2 TW Pickups  
1 Push-Pull Pot as Master Volume  
(1 Push-Pull Pot as Master Tone  
B245 Buss  
Toggle Style Switch



**Diagram #9**

- 2 TW Pickups
- 2 Push-Pull Pots as Volume controls (Volumes are independent)
- 1 Master Tone (Passive)
- Toggle Style Switch



**Diagram #10**

- 2 TW Pickups
- 2 Push-Pull Pots as Volume controls (Volumes are independent)
- 2 Tones (Passive)
- Toggle Style Switch

