



ASTON MICROPHONES

Owners Handbook



Thank you!

On behalf of the whole team at Aston Microphones I'd like to thank you for investing in your Aston product.

Our microphones are designed and built in the UK to the most exacting standards. Every Aston product is individually tested at each key stage during manufacture to ensure reliable and consistent performance, and the most musical sound capture possible, so we're sure that your new baby will provide you with many years of perfect service.

Aston microphones are built using a tumbled stainless steel body so there is no paintwork to chip or scratch and legends are laser etched so will never wear off. Our packaging has been designed to save space, and focus on being as environmentally sustainable as possible, using 84% recycled materials and being 100% recyclable.

Your Aston microphone has been voiced and tuned following extensive blind listening tests by a panel of some of the biggest names in British music recording and production. Only when an overwhelming consensus put one particular combination of capsule and circuitry way out in front of both competing microphones and our other prototypes did we approve the designs.

We hope you enjoy what we've created, and thank you for supporting our brand

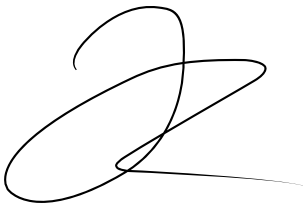
A handwritten signature in black ink, consisting of a large, stylized 'J' followed by a horizontal line that loops back under the 'J'.

James Young

Aston Microphones

Hitchin, UK

Contents

Aston Origin & Spirit	5
Aston Starlight & Starlight Stereo Pair	12
Aston Halo & Halo Shadow	18
Using Your Aston Microphone	21
Microphone Terminology & General Care	26

Aston Owners Club

Please register your product to extend your 2 year limited replacement warranty to 3 years, free of charge.

You'll be automatically given membership to our exclusive Aston Owners Club once you've registered here:

www.astonmics.com/owners-club

Aston Origin & Spirit

Features:

- Wave-form mesh head - this unique design provides shock absorption to protect the capsule, with elastic mesh memory.
- Built-in pop filter using the latest stainless steel mesh-knit technology.
- Direct to stand microphone mounting option.
- 2mm, solid stainless steel, laser-cut and etched chassis.
- Capsule - The Aston Sound - developed by professional artists, engineers and producers. (www.astonmics.com/the-aston-sound)
- Hi-Spec PCB and electronic components.
- Eco-friendly packaging. Well-designed, re-usable and recyclable packaging.

Weights & Measures

	Aston Origin		Aston Spirit	
Product length	125mm	4.92in	175mm	6.89in
Product width	54mm	2.13in	54mm	2.13in
Product weight	450g	0.99lb	625g	1.38lb
100% recyclable and biodegradable card box (84% recycled fibre)	72g	0.16lb	72g	0.16lb
100% recyclable and biodegradable card sleeve	22g	0.05lb	22g	0.05lb
100% recyclable non cross-linked Ethafoam 150 PE25 insert	40g	0.09lb	37g	0.08lb



Aston Origin

The Aston Origin is a high-performance cardioid pattern capacitor microphone utilising a one inch capsule with a gold evaporated Mylar diaphragm. It is versatile enough to use with most instruments, excelling on both acoustic guitar and vocals. Its hand-selected capsule is teamed with high-end transformer-less circuitry using only the highest quality selected components.

The Origin is designed to deliver a direct, smooth and intimate sound with the perfect balance of warmth and clarity for a natural-sounding and transparent recording.

Origin specifications:

- Transducer Type: Capacitor
- Acoustic Operating Principle: Pressure Gradient
- Directional Polar Pattern: Cardioid
- Frequency Response: 20Hz - 20kHz (+/- 3dB)
- Equivalent Noise Level: 18dB A-Weighted
- Sensitivity at 1 kHz into 1kohm: 23mV/Pa
- Maximum SPL for THD 0.5%: 127dB
- Pad Switch: -10dB/0 dB
- Low-Cut Filter: 80Hz
- 48 Volt Phantom power (+/- 4 Volts) is required for operation

Frequency Response

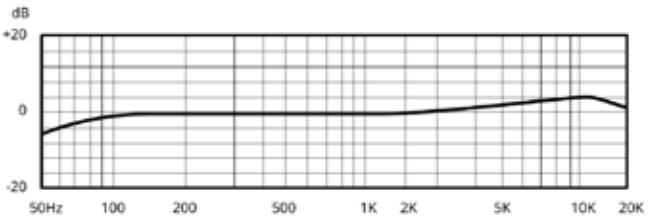

Polar Pattern

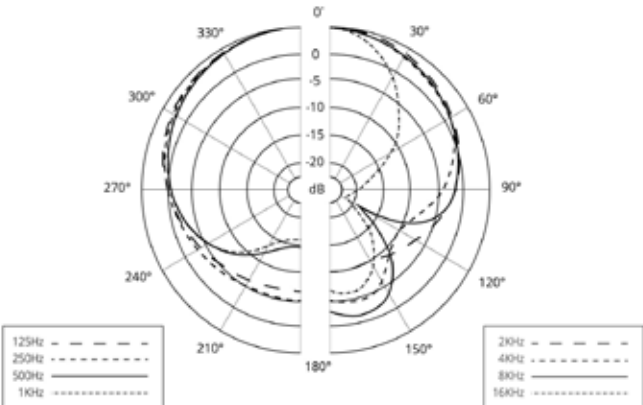

Cardioid Condenser

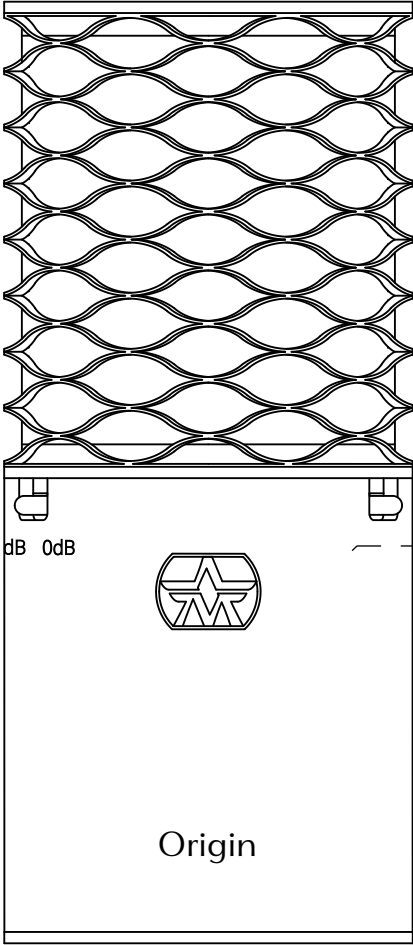

Aston Spirit

The Aston Spirit is a high-performance, switchable pattern, microphone utilising a one inch, dual diaphragm, gold evaporated capsule. A switch on the mic body selects from Omni, Cardioid or figure-of-eight polar patterns. It is versatile enough to use with most instruments in addition to main and backing vocals. Its hand-selected capsule is teamed with high-end transformer balanced circuitry using only the highest quality electronic components. Its dual pad option allows it to accommodate very high SPLs while its low cut filter cuts the ultra-lows.

The Spirit is designed to deliver a beautifully open sound with sparkling harmonics. This microphone is capable of delivering a stunningly natural and transparent sound with just a subtle hint of flattery, capturing all the detail in the high range but without adding the harshness that some capacitor microphones are prone to.

Spirit specifications:

Transducer Type: Capacitor

Acoustic Operating Principle: Pressure Gradient

Frequency Response: 20Hz - 20kHz (+/-3dB)

Equivalent Noise Level: 14dB A-Weighted

Sensitivity at 1kHz into 1kohm: 23.7mV/Pa

Maximum SPL for THD 0.5%: 138dB

Polar pattern: Omni/Cardioid/Figure-of-Eight

Pad Switches: -20dB/-10dB/0dB

Low-Cut Filter: 80Hz

48 Volt Phantom power (+/- 4 Volts) is required for operation

Frequency Response

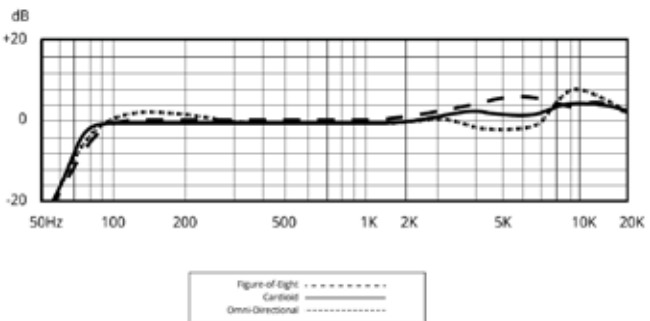

Multi-Pattern Condenser

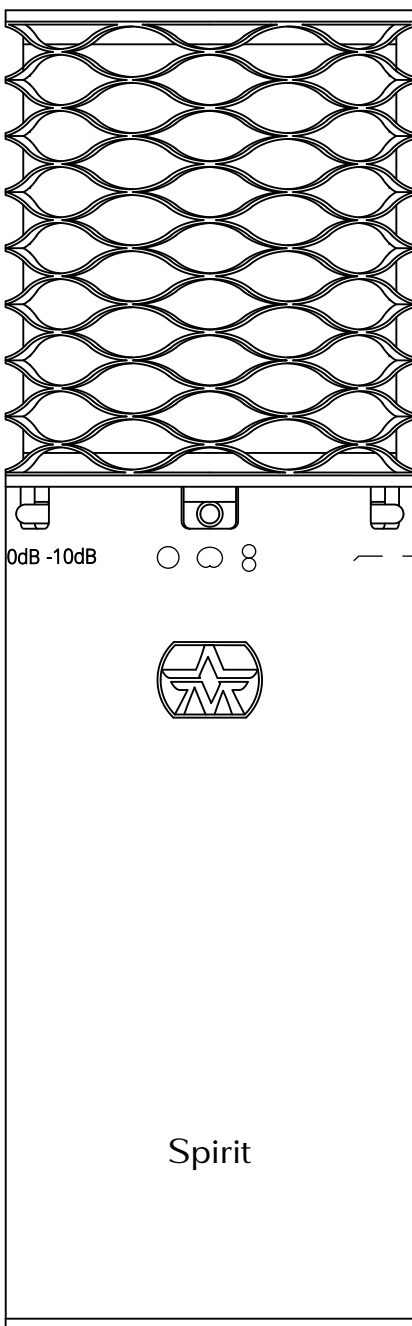

Polar Patterns

Figure-of-Eight

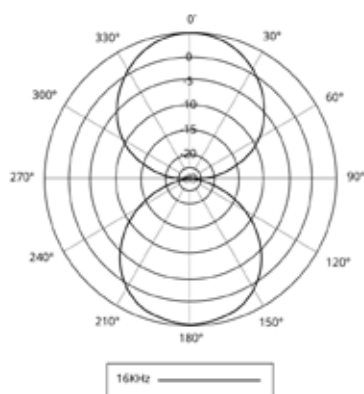

Cardioid

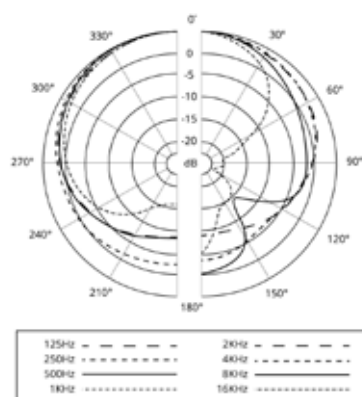

Omni-Directional

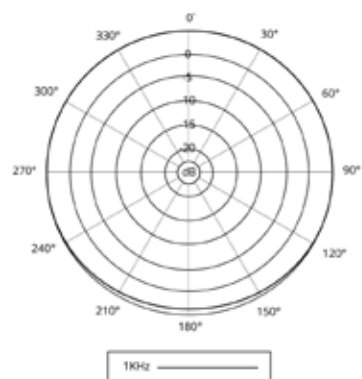



Aston Starlight & Starlight Stereo Pair

Features:

- Laser-alignment sight for placement accuracy and recording recall
- Sintered metal head - unique & innovative design protects capsule and provides excellent acoustic properties
- Gold-sputtered 20mm capsule, chosen in blind tests by a panel of 50 top producers
- PCB - market-leading electronic design
- 1.5mm, solid stainless steel, laser-cut and etched chassis
- 3-position voicing switch: Vintage, Modern and Hybrid settings
- Pad switch: -20dB/ -10dB/ 0dB
- 3-position Low-Cut Filter
- Stereo pair comes with full suspension kit including Rycote shock mounts, mounting bar, windscreens & mic clips

Weights & Measures

	Aston Starlight		Aston Starlight Stereo Pair	
Product length	181mm	7.13in	181mm	7.13in
Product width (with laser)	36mm	1.42in	36mm	1.42in
Product width (without laser)	26mm	1.02in	26mm	1.02in
Product weight	251g	0.55lb	502g	1.1lb
Accessory weight	52g	0.11lb	392g	0.86lb
100% recyclable and biodegradable card box (84% recycled fibre)	72g	0.16lb	164g	0.36lb
100% recyclable and biodegradable card sleeve	22g	0.05lb	55g	0.12lb
100% recyclable non cross-linked Ethafoam 150 PE25 insert	44g	0.10lb	130g	0.29lb



Small Diaphragm Cardioid Condenser

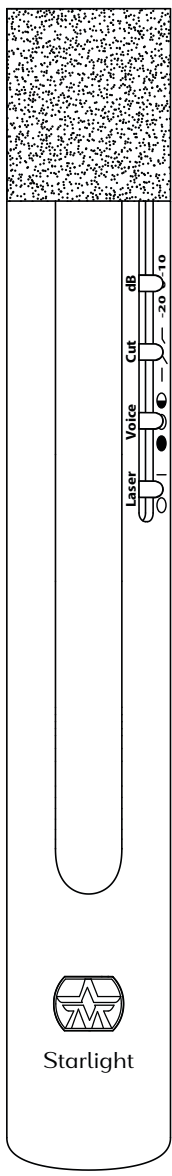
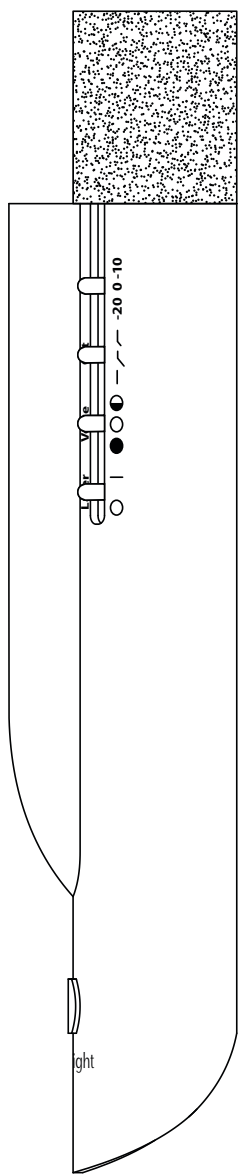

Aston Starlight

The Starlight is a small diaphragm, end fire condenser microphone featuring a sintered metal head which combines extreme durability with extraordinary audio transparency.

The addition of a laser not only makes precise alignment easy, it also helps achieve consistency when re-establishing the microphone position after de-rigging.

The 20mm gold sputtered capsule feeds into custom designed transformerless electronics, with low noise and ultra-low distortion as priorities. Using proprietary circuitry at the input stage of the mic amp rather than simple post-EQ, we have also given Starlight three different voices accessed via a switch on the microphone body.

Vintage voicing [●] introduces some subtle low end lift while gently rolling back the extreme highs for a classic warm, smooth sound. The 'middle' Modern setting [○] adds some airy high-end lift while the third Hybrid setting [◐] delivers a nominally flat response but with just a little low end lift. With its laser guide, sintered head and multiple voices, Starlight is the most comprehensive instrument mic package on the market today.

Starlight audio specifications:

Transducer Type: Capacitor

Acoustic Operating Principle: Pressure Gradient

Directional Polar Pattern: Cardioid

Frequency Response: 20Hz - 20kHz (+/- 10dB)

Equivalent Noise Level: 15dB A-Weighted

Sensitivity at 1kHz into 1kohm: 42.1mV/Pa

Maximum SPL for THD 0.5%: 130dB/ 140dB/ 150dB

Signal-to-Noise Ratio (rel. 94dB SPL): 79dB A-Weighted

Pad Switches: -20dB/-10dB/0dB

Low-Cut Filters: 80Hz, 140Hz

48 Volt Phantom power (+/- 4 Volts) is required for operation

Frequency Response

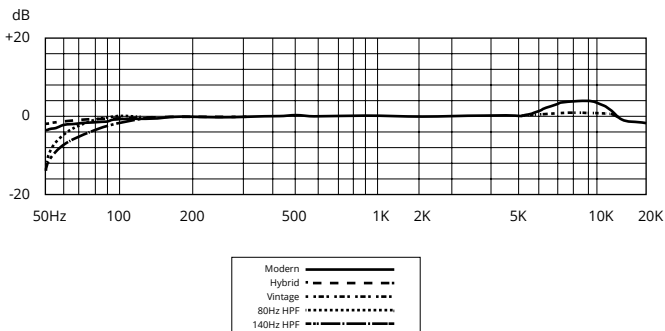

Polar Pattern

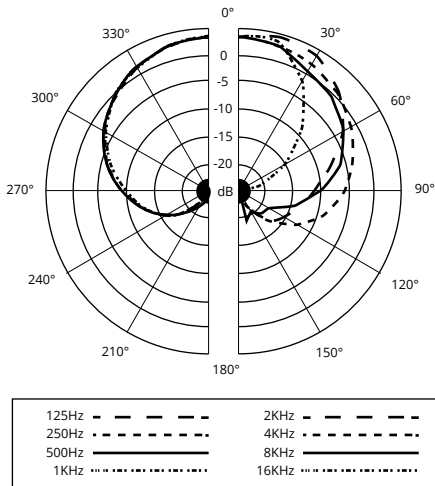

Starlight Laser

The Aston Starlight is equipped with a Class 2 Laser driven by 48V phantom power provided via the XLR cable from a mixing console/mic preamp. It does not require any batteries. The Starlight's laser is emitted through the laser aperture located on the top front of the microphone. Switch the Laser to the "I" position to turn it on and "O" position to turn it off. The Laser is not designed to be left on during use.

Starlight laser specifications:

Wavelength: 650nm

Divergence (Spot Size or Beam Diameter): 10x10mm @ 5m

Maximum Average Power: 0.9mW

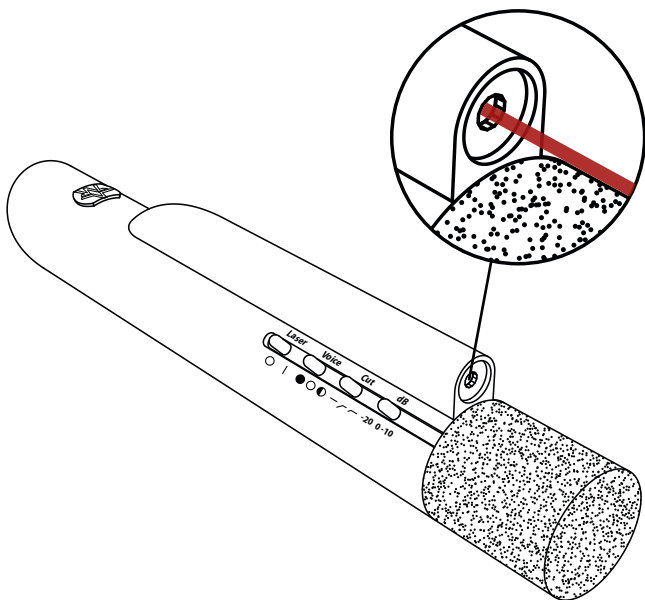

CAUTION

Though the laser is of a very low power, the following precautions should be observed. Never aim a laser into the eyes or stare directly into the beam and only activate the laser while setting up the microphone position. Check that nobody is in the path of the laser before switching it on. When working outdoors, ensure that the laser is never aimed into the flightpath of aircraft or into the audience. Use of controls or adjustments or performance of procedures other than those specified herein may result in hazardous radiation exposure.



Starlight

Aston Halo & Halo Shadow

Features

- Hi Tech construction with patented PET felt
- Radically improves isolation
- Double curved form improves isolation top and bottom as well as at the sides
- Much bigger surface area and depth of acoustic material
- Better diffusion, for both direct source and primary reflections to the rear of the filter
- Lightweight
- Proprietary 'easy-mount' hardware also accommodates your microphone mounting hardware

Weights & Measures

	Aston Halo		Aston Halo Shadow	
Product depth	302mm	11.89in	302mm	11.89in
Product width	530mm	20.87in	530mm	20.87in
Product weight	1.85kg	4.08lb	1.85kg	4.08lb
100% recyclable and biodegradable card box (84% recycled fibre)	2.25kg	4.96lb	2.25g	4.96lb
100% recyclable and biodegradable covering box	0.8kg	1.77lb	0.8kg	1.77lb





Aston Halo & Halo Shadow

The Aston Halo/ Halo Shadow microphone screen is designed to address the shortcomings of other 'reflection filter' style products combining low weight with minimal audio colouration.

Designed, engineered and tested in the UK, the Halo combines modern advances in material technology and production, cutting edge patented manufacturing processes and rigorous acoustic testing to bring you the ultimate in portable acoustic devices.

Using patented PET Felt and beautifully engineered hardware components, your Aston Halo has been created to the most exacting standards. PET felt is one of the most lightweight and efficient, technical acoustic products available on the global market today. An additional side benefit is that PET acoustic felt is made from 70% recycled PET plastic bottle material and so is also very environmentally friendly.

The Halo is actually made from two PET felt shells, with 100mm of PET acoustic foam sandwiched internally. These rigid shells provide the structure as well as the absorbing surface, removing the need for any internal support, making Halo incredibly light and strong. Halo's hardware allows easy, fast and stable mounting. Every Aston Halo is individually tested during manufacture to ensure reliable and consistent performance and the most musical sound capture possible.

The Halo offers radically improved performance while maintaining the green credentials of our manufacturing process (as with our mic packaging which is 100% recyclable and 84% recycled material). It also contributes both sonically and visually to the creative environment, helping the artist to get the best from every take. In our opinion, the Halo offers the very best possible solution for portable room acoustics available today.

How to setup and use my Aston Halo

The Halo can greatly improve the quality of recordings made in untreated or partially treated rooms. To get more information about how to setup and use the Aston Halo reflection filter please visit:

www.astonmics.com/halo

www.astonmics.com/halo-shadow

Using Your Aston Microphone

If you are an experienced audio practitioner, then you'll need little instruction in using Aston microphones - just apply standard 48 Volt Phantom power to our capacitor models and you're in business. For the Spirit and Origin models, the Aston badge denotes the front of the microphone when using cardioid pattern for main vocals, guitars and so on. When using the Spirit in figure-of-eight mode, the logo denotes the 'positive' side of the microphone. The Starlight is end-fire, meaning that it needs to be aimed directly at the sound source where the laser helps with exact placement. If you're still fighting your way up the learning curve, the following section will help get you up to speed.

Recording Vocals

Vocals are most often recorded using a side-address, large diaphragm, cardioid-pattern capacitor microphone though the Starlight is also capable of capturing high quality vocals. Whichever microphone you choose, it is important that the space in which vocals are recorded is free from unwanted room reflections, something best achieved by using an Aston Halo or Halo Shadow reflection filter behind the microphone. Using adequate absorption is particularly important for all microphone patterns as even cardioid models are very sensitive at the sides. Controlling the acoustics is particularly important for any sound source that will be subjected to dynamic compression at a later stage as compression tends to exaggerate room ambience.

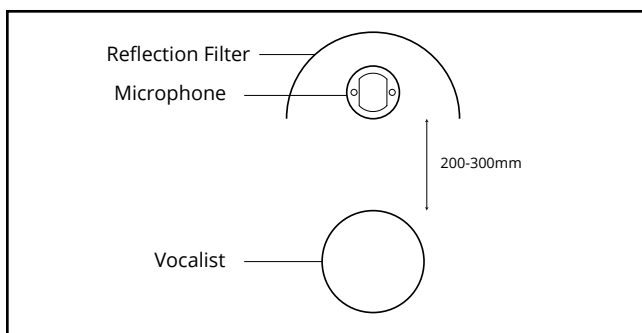

In the event that a reflective wall is located behind the performer, then further absorption behind the performer may be helpful in preventing wall reflections reaching the 'hot' side of the microphone. See Using Your Halo for more details.

A vocal mic is typically placed at a distance of 200 to 300mm from the mouth. The built in knitted mesh pop filter will minimise plosives (those pesky P, B and M sounds), and switching in the low-cut filter can also help. However, many singers benefit from an additional pop screen placed around 25 to 50mm in front of the microphone where the metal mesh and reticulated foam types are the most transparent sounding. If the vocal

sound is too bright, the tonality can be adjusted by rotating the microphone a few degrees to the side so that the vocalist is singing slightly off axis. The further off-axis, the more the high end will be softened.

When using cardioid or figure-of-eight patterns, the proximity effect will cause the sound to become more bass-heavy the closer the microphone is to the mouth. A skilled vocalist can sometimes exploit the proximity effect to control the voice timbre while recording but less-experienced vocalists are safest keeping a fixed distance from the mic.

Acoustic Guitar

When setting up to record acoustic guitars, the textbook miking positions should only be used as a guide. A good starting point is to aim the mic at where the neck joins the body and then adjust until you find the sweet spot that gives the best tonal balance. As the mic is moved closer to the sound hole, the level of the low end will increase; move it further along the neck and the low end will decrease.

Acoustic guitar can be recorded using either large diaphragm microphones or small diaphragm models depending on what you have to hand. As with vocals you can try different polar patterns though many users stick with cardioid so as to minimise spill. If you do use figure-of-eight or omni patterns, you'll pick up more room ambience so use screens if the sound of the room isn't sympathetic to the instrument. A Halo behind the mic is ideal for reducing the contribution of room ambience.

Every guitar is different and its interaction with the room will also affect the sound. A hard floor helps maintain a lively tone so if you have carpet in your recording area, try placing a sheet of hardboard, ply-wood or MDF on the floor between the instrument and the microphone.

Start with the microphone about 200 to 300mm from the body

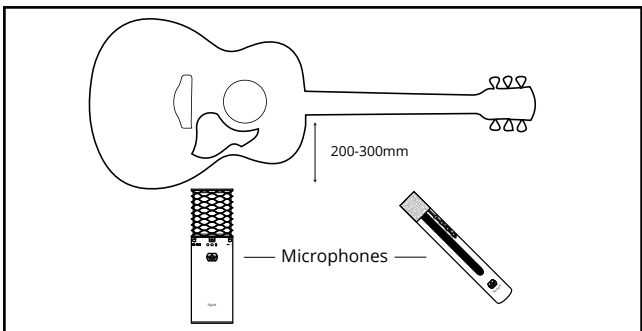

of your guitar (aimed at the point where the guitar neck joins the main body), and listen on good isolating headphones while moving the body of the guitar in relation to the mic until you get a sound you like. You'll probably find that at some point the sound just seems to come into focus. Isolating headphones are crucial so that you hear only what the recording system will hear. While it is possible to mic the acoustic guitar in stereo or even

pseudo stereo by having one mic on the body and one aimed somewhere along the neck, the stereo image will tend to shift if the player moves around, even slightly. For pop work, a mono recording with artificial stereo ambience added later may be a more appropriate option. Stereo recording is more useful when miking from a greater distance to capture both the sound of the instrument and the contribution of the room acoustics - for example when recording a classical guitar recital in a hall. In that situation the mic distance needs to be adjusted until the right balance of direct sound and room ambience is achieved.

Starlight Options

If the guitar needs more 'zing', try the Modern voicing whereas if it sounds a little lightweight, the Hybrid setting may produce a better result. Once you find the best mic position, make a note of where the laser spot is visible and also measure the mic-to-guitar distance. Better still, take a photo on your phone as that will show the light spot and you can include the mic-to-instrument distance in the photo file name.

Electric Guitar

There are many ways to record the electric guitar but the classic approach is to use a cardioid pattern microphone fairly close to the amplifier's speaker grille. Some engineers like the mic to be almost touching the grille while others may back it off by 150mm or more so make a few test recordings and see what sounds right to you. If there's too much signal level, use the pad switch to attenuate the microphone output. The tonality will also be affected by whether the mic is aimed at the centre of the speaker or towards the edges, so again experimentation is the key. Also be aware that when using cardioid and figure-of-eight pattern mics, the tonality will be affected by mic distance where closer placement will tend to emphasise the low end more because of the proximity effect. Choosing the right electric guitar mic is more about character than technical spec so try

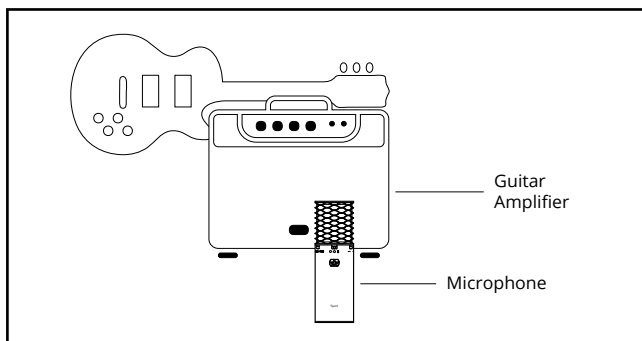

whatever mics you have to hand to see what produces the most pleasing result. If you find that close miking with one of your dynamic models sounds encouraging, try combining that with one of your Aston mics placed between one and three metres from the amplifier. This will add a little more 'space' around the sound while adjusting the distance will also change the timbre of the recorded sound when the two mic signals are mixed.

Drums

Drums are usually mic'd using one close-up cardioid pattern mic for each drum plus a pair of overhead mics to capture the cymbals and overall kit sound. A separate hi-hat mic can be used if the hi-hat isn't loud enough. Capacitor mics are the usual choice for overheads though ribbon mics are sometimes chosen in this role. Any of the Aston models will work well as drum overheads. The close mics can be either dynamic or capacitor but must be small enough not to get in the drummer's way.

A high SPL handling is necessary because the mics are so close to the drums so use the pad switch on your Aston microphone. The Spirit is particularly useful for drums as it has both 10 and 20dB pads. Use a capacitor mic, such as the Starlight, for the hi-hat if you need a separate hi-hat mic.

If you don't have enough mics or fancy trying a simpler approach, use a mic on the kick drum, a pair of overheads to pick up the rest of the kit and perhaps a separate snare mic. You might also want to try bringing the overheads forward so they are a metre or so in front of the kit. The trick is to find the place that gives the best balance of drums and cymbals.

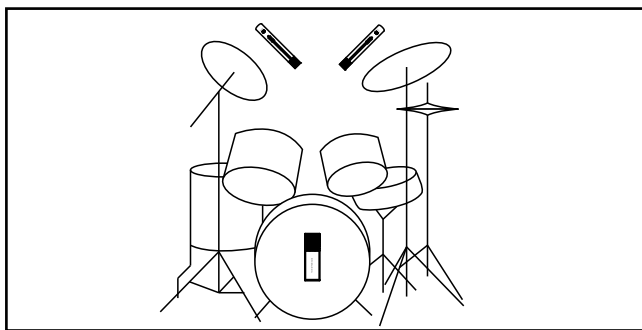

Close drum mics are set up typically 30 to 60mm from the drum heads, usually 'looking' over the rim and aimed down towards the centre of the head. Just make sure that they are placed where the drummer isn't likely to hit them! Rim clip mounts save cluttering up the area with mic stands.

You can mic the hi-hat from the side at a distance of 150mm or so, but place the mic above or below the plane of the cymbals to avoid it receiving a blast of air when the hi-hats are closed suddenly. Also try to aim it where it will pick up the least spill from the other drums. The voicing options of the Starlight come into play when using as a hi-hat or under-snare mic where the Modern setting can liven up the sound with the options of the Vintage or Hybrid voicings to add weight.

For the kick drum, using a front head with a hole cut into it is very common as this allows the mic to be positioned just inside the drum shell, 100 to 150mm from the inside of the shell and aimed towards the beater impact point. Most engineers choose a moving coil microphone with an extended bass response, though you can try pretty much any capacitor microphone that can tolerate SPLs of 135dB or more. If there's no hole in

the front head, try mic'ing the drum from behind at a distance of 100 to 200mm. Just make sure it doesn't pick up any pedal squeak. You can also try a large diaphragm capacitor mic such as the Origin or Spirit set up maybe 300mm in front of the kick drum.

The overhead mics are very important, and also the most problematic in small studios. Ideally drums should be recorded in a high room with the overhead mics 1 to 1.5 metres above the cymbals and spaced apart by around the same amount. In smaller studios, ceiling and wall reflections can degrade the sound of the overhead mics making the kit sound boxy so use your blankets, duvets and foam panels to 'dry up' the area around the overhead mics. A perfectly valid alternative to a spaced pair is to set up the two overhead mics as a coincident pair and then adjust their position to give the best overall balance, the advantage being that the two mics will always be the same distance from the snare drum regardless of whether they are placed over the centre of the kit or offset in some way to fine tune the balance.

In a room with low ceilings, reflections from the ceiling can compromise the sound reaching the overhead mics. One practical, low cost solution is to fix some acoustic foam to the ceiling above the kit and then move the mics up so that they are actually touching the foam. This approximates a boundary mic situation and reduces the magnitude of ceiling reflections reaching the mics by a significant margin. A true boundary mic would have its capsule flush with the ceiling, but clearly the length of the mic body makes this configuration impossible. However, in combination with the foam to absorb the higher frequencies, this approach is usually an acceptable compromise. If using Starlights, try all three voicing settings as the differences in drum kits, room acoustics and musical styles mean that there is no one 'best' voicing option.

A useful tip is to place the two overhead mics equal distances from the snare drum centre so that there will be no phase errors if the recording is played back in mono. The snare sound is the most adversely affected by phase errors because of its high frequency content. If using a pair of Starlights as overheads you can use the lasers to help finesse your mic placement. As a rule, overhead placement becomes more critical if not using separate tom mics as their position will affect the balance of the toms as well as the cymbals.

When mixing, ensure that the close mics are panned to match the stereo image captured by the overhead mics.

Piano

Pianos are usually recorded in stereo where you can use a pair of spaced microphones (omni or cardioid spaced 1 to 1.5 metres apart) or a coincident pair of cardioid mics set at an angle of 90 to 120 degrees. Capacitor mics are the best choice as they have the widest frequency range. For upright pianos, remove the upper casework and position the mics around one metre above the piano. For grand pianos, put the lid on its prop and

then stand the mics one to two metres from the piano aimed at the centre of the inside of the open lid. The lid acts as a reflector to project the sound of the strings and soundboard. There are many other mic'ing variations for piano, including getting closer to the strings for a more pop-style sound, so as always, experimentation is the only way to get the best sound but pay particular attention to getting an even level balance across the strings.

For upright pianos, try removing the upper casework and placing a spaced or coincident pair of microphones 600mm or so above the piano, again adjusting the position to get an even level across the keyboard.

When using a pair of Starlights, the lasers ensure the mics are aimed where you want them, a prime example being the grand piano where the lasers spots will be clearly visible on the inside of the open lid.

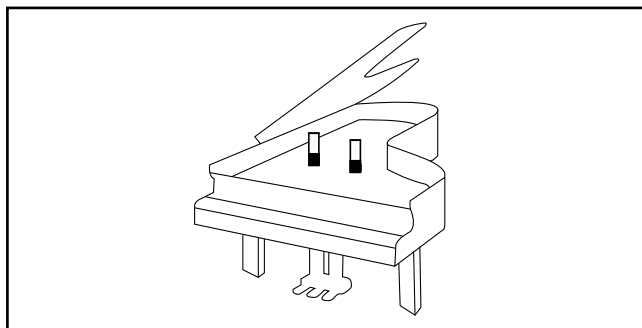

Microphone Terminology

Pad: The pad switch on a microphone reduces its output level, which is often necessary when working close to very loud sound sources such as kick drums, guitar amplifiers or brass instruments. At very high sound levels the electrical signal generated by the microphone can cause distortion both in the microphone circuitry itself and in the pre-amp to which it is connected. If your pre-amp meters indicate a safe level but you are still hearing distortion, then try the 10dB pad position. Mics that have a 20dB pad setting can deal with even higher sound levels, but unless you are in the habit of recording tank battles at close quarters, you'll probably find that the 10dB pad does the trick. Do not use the pad when working with quiet or moderate level sounds as under those circumstances it may lead to slightly more background noise (circuit hiss).

Low-cut Filter: The low cut filter reduces the level of signals at the bottom of the audio spectrum and in most cases will have little or no effect on the tonality of vocal recordings. Its purpose is to reduce the level of those very low frequencies that you don't need to capture, and unless you are recording bass instruments or kick drums, you can usually leave the filter engaged. Where the mic has two filter settings, try both and use the highest one if you can't hear any tonal changes in what you

are recording. When recording vocals a low-cut filter will reduce rumble from traffic noise or from vibrations passing up the mic stand from the floor and will also compensate for the bass lift that occurs naturally when a cardioid pattern mic is used close to the mouth. It can also help reduce the effect of 'popping' when enunciating M, P and B sounds, though a separate pop screen is to be recommended where the singer works close to the microphone.

General Care

While Aston microphones are amongst the most durable capacitor microphones on the market, they should still be handled with care. If cleaning is required, use only a damp cloth or pre-moistened screen wipe pads and avoid harsh or solvent based cleaners. Also never spray any type of contact cleaner or polish near the capsule or basket area.

The high impedances inside capacitor microphones make them susceptible to moisture or condensation, so if you hear any strange crackling sounds, leave the mic to dry out in a warm room. This is particularly important when moving a microphone from a cold vehicle to a warm studio where a vocalist's damp breath can otherwise cause problems. Once dried out the performance should return to normal.

Obviously dropping microphones is to be avoided but one advantage of the Origin and Spirit basket design is that the outer Wavespring is designed to deform if subjected to a knock or impact, thus absorbing much of the energy. This can easily be pushed back into place making dented baskets a thing of the past. When not in use, it is good practice to store microphones in their boxes or to cover them with a plastic bag to avoid the ingress of dust.

When using a typical boom stand, make sure that the boom is aligned with one of the three legs as this provides the most stable configuration and reduces the risk of toppling.



ASTON MICROPHONES



BUILT IN BRITAIN

3 Hunting Gate, Hitchin, Hertfordshire, SG4 0TJ, United Kingdom
Tel. +44 (0)845 500 2 500
www.astonmics.com