

Operation Manual

Benutzerhandbuch

Fonctions Détaillées

Manual de Operaciones

Manuale Operativo

オペレーションマニュアル

USB AUDIO INTERFACE **UR 28 M**



EN
DE
FR
ES
IT
JA

 **steinberg**

Contents

Introduction.....	3
Contents in this Operation Manual.....	3
Features	3
Panel Controls and Terminals (Details).....	4
Rear Panel.....	4
Front Panel	6
Panel Controls for the Software Programs	9
Control Panel of the Audio Driver.....	9
dspMixFx UR28M.....	10
Dedicated Windows for Cubase Series	16
Sweet Spot Morphing Channel Strip (Channel Strip). ..	20
REV-X	23
Usage Examples	25
Introduction	25
Recording with the Channel Strip and REV-X.....	25
Controlling the Monitor Sound	26
Using the Device Without a Computer.....	27
Appendix	28
Glossary	28
Contents of the Getting Started Section	29
Signal Flow.....	30
Block Diagrams.....	32

Introduction

Contents in this Operation Manual

This Operation Manual explains how to use the device. The explanations in this manual assume that you've set up the device and prepared it for use according to the included Getting Started document. If you haven't done that yet, refer to the Getting Started document and complete the setup before reading this manual.

Features

High-resolution Microphone Preamplifiers (D-Pre)

Discrete microphone preamps featuring a high-performance inverted Darlington circuit configuration achieve low distortion and noise while delivering sound with eminently musical balance and character.

Convenient Monitor Control

Up to three sets of monitor speakers can be connected to the unit, with versatile control of monitor output provided via convenient buttons and knobs: volume, mute, mono mix, and dimmer. There are two functions (modes) regarding monitor control: the Alternate mode, which lets you select a set of monitor speakers for signal output, and the Independent mode, which lets you select the signals for outputting to each set of monitor speakers simultaneously.

Supports a Variety of Inputs

Switchable phantom power is provided for condenser microphones, electric guitars and basses can be directly connected via a HI-Z (high impedance) input, and a PAD is provided for input matching with high-level signals from electronic instruments. A stereo mini-jack 2TR IN input provides a convenient way to connect portable music players, and coaxial S/PDIF connectors enable direct connection to a variety of digital audio devices.

Powerful DSP Mixer (dspMixFx)

A DSP mixer that can mix up to six input channels to three stereo outputs is built in. A number of DSP effects that can be applied to input signals are also provided, and since it is a hardware mix with there is no monitoring latency.

DSP Effect: Sweet Spot Morphing Channel Strip

The Sweet Spot Morphing Channel Strip ("Channel Strip" for short) is a multi-effect that combines compression and EQ. Advanced sound engineering know-how is condensed into a number of presets that can simply be recalled as required for professional results. Four channel strips are provided, and each can be assigned to the monitor sound only, or to both the monitor and recorded sound.

DSP Effect: REV-X Reverb

REV-X is a digital reverb platform developed by Yamaha for pro audio applications. One REV-X effect is included in this unit. Input signals can be sent to the REV-X effect, and the REV-X effect is applied only to the monitor outputs.

DSP Effect VST Plug-ins Included

VST Plug-in (VST3.0, page 28) versions of the Channel Strip and REV-X effects are included for use with Cubase series or similar VST-compatible DAW software.

Cubase AI Included

Steinberg Cubase AI digital audio workstation (DAW, page 28) software is included. Cubase AI is the entry-level version of the Cubase series DAW products, providing the basic functionality you need for music production and editing.

Panel Controls and Terminals (Details)

Rear Panel

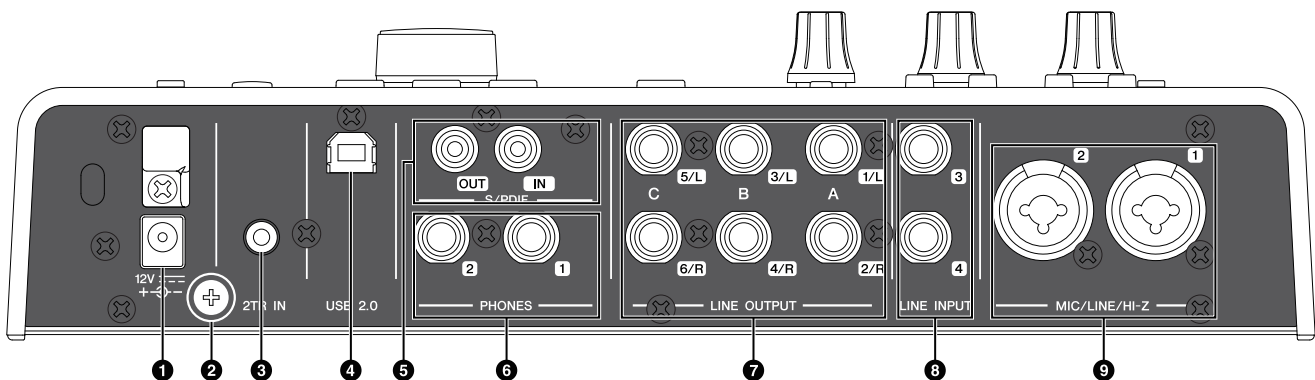

❶ DC IN 12V

For connection to the AC power adaptor.

❷ Grounding screw

For connection to a ground wire.

If you have a problem with hum or noise, use this terminal to connect to ground. The noise may be reduced.

❸ 2TR IN (3.5 mm, stereo)

For connection to a portable audio player.

The input signal at 2TR IN flows only to MIX 1 (page 28), and not to the computer.

❹ USB2.0 (USB port)

For connection to a computer.

❺ S/PDIF IN/OUT (coaxial)

For connection to a digital audio device.

S/PDIF OUT outputs one of the MIX 1–3 and DAW OUT signals. To select the output signal, use the “Setup Window” (page 15) in the section “dspMixFx UR28M” or the “Output Routing Window” (page 20) in the section “Dedicated Windows for Cubase Series”.

S/PDIF IN is equipped with the SRC (Sampling Rate Converter) function. Even if the sampling rate at which the device is operating differs from the sampling rate of the audio signal input to the S/PDIF IN, the SRC function will automatically convert the rate so that playback will be correct. SRC is only available when INTERNAL is selected as the clock source of the device. To select the clock source of the device, use the “(device name) Window” (page 9) in the section “Control Panel of the Audio Driver” in Windows or Audio MIDI Setup in Mac.

❻ PHONES 1/2 (phone type, stereo)

For connection to a set of headphones.

PHONES 1 outputs the MIX 1 signal. PHONE 2 outputs one of the MIX 1–3 signals. To select the output signal of PHONES 2, use the “Headphone Area” (page 14) in the section “dspMixFx UR28M” or the “Headphones Window” (page 19) in the section “Dedicated Windows for Cubase Series.”

❼ LINE OUTPUT A–C (phone type, balanced/unbalanced)

For connection to monitor speakers. When the monitor speakers have a balanced input, connect them with a balanced cable.

There are two functions (modes) on LINE OUTPUTS A–C: Alternate and Independent. In the Alternate mode, one of the LINE OUTPUTS A–C selected by the OUTPUT buttons A–C outputs a single MIX signal selected by the SOURCE SELECT button. In the Independent mode, LINE OUTPUTS A–C output each MIX selected by the SOURCE SELECT button simultaneously.

For details on the mode, including how to select the mode, refer to the “Setup Window” (page 15) in the section “dspMixFx UR28M” or the “Master Levels Window” (page 20) in the section “Dedicated Windows for Cubase Series.”

⑧ LINE INPUT 3/4 (phone type, balanced/unbalanced)

For connection to a digital instrument.

You can select the input signal level of LINE INPUT 3/4 between “+4dBu” and “-10dBV.”

Select “+4dBu” when connecting a professional audio device, and select “-10dBV” when connecting a consumer device. The default initial setting is “+4dBu.” To select the input signal level, use the “Setup Window” (page 15) in the section “dspMixFx UR28M” or the “Settings Window” (page 20) in the “Dedicated Windows for Cubase Series.”

⑨ MIC/LINE/HI-Z 1/2 (XLR/phone type, balanced/unbalanced)

For connection to a microphone, digital instrument, electric guitar, or electric bass.

Front Panel

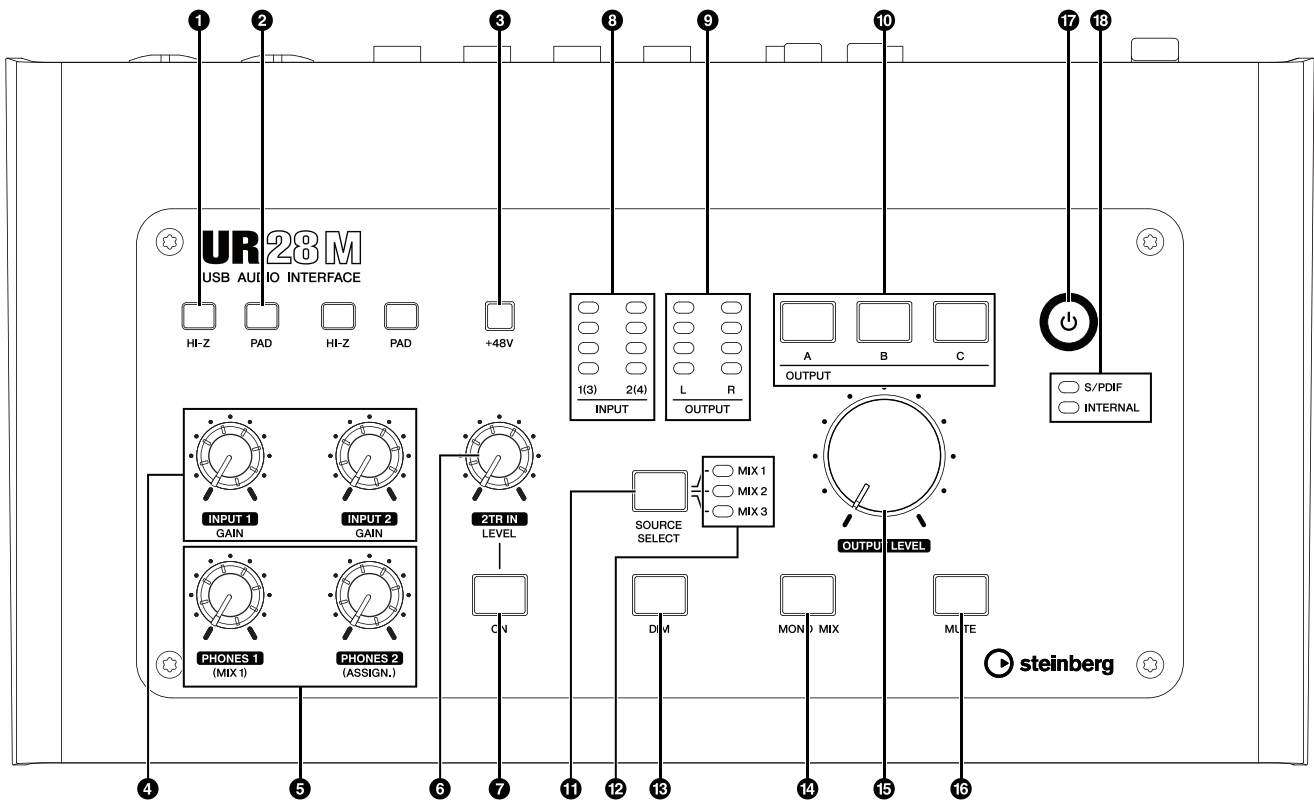

1 HI-Z switch

Turns on (☐) and off (▣) the HI-Z of the MIC/LINE/HI-Z.

Turn this switch on when connecting high impedance instruments, such as an electric guitar or electric bass, directly to the MIC/LINE/HI-Z.

When you turn this switch on, use an unbalanced phone cable for connection between the instruments and the MIC/LINE/HI-Z. If you use a balanced cable or an XLR cable, this device will not work correctly.

⚠ CAUTION

- Do not connect or disconnect a device while turning on the HI-Z switch. Doing so can damage the connected device and/or the unit itself.
- To protect your speaker system, leave the monitor speakers turned off when turning the HI-Z switch on/off. It's also a good idea to turn all output volume controls down to their minimum. Neglect of these precautions may result in large noise bursts that may damage your equipment, your ears, or both.

2 PAD switch

Turns on (☐) and off (▣) the PAD of the MIC/LINE/HI-Z.

When you turn this switch on, the input signal level of the MIC/LINE/HI-Z will be attenuated by 26 dB. Turn this switch on when connecting high output equipment, such as a synthesizer, to the MIC/LINE/HI-Z.

3 +48V button

Turns on (lit) and off (dark) the phantom power of the MIC/LINE/HI-Z 1 and 2 (XLR type).

When you turn this button on, phantom power will be supplied to the MIC/LINE/HI-Z 1 and 2. Turn this button on when connecting phantom powered devices, such as a condenser microphone, to the MIC/LINE/HI-Z 1/2.

⚠ CAUTION

- Make sure that phantom power is turned OFF unless it is needed.

- When turning phantom power ON, make sure that no equipment other than phantom-powered devices such as condenser microphones are connected. Devices other than condenser microphones may be damaged if connected to the phantom power supply. Note, however, that the switch may be left on when connecting to balanced dynamic microphones. When connecting an unbalanced device to the MIC/LINE/HI-Z 1/2 and phantom power is turned on, hum or noise may result; this is not a malfunction or failure in the device.
- Do not connect or disconnect a device while phantom power is applied. Doing so can damage the connected device and/or the unit itself.
- To protect your speaker system, leave the monitor speakers turned off when switching the phantom power on/off. It's also a good idea to turn all output volume controls down to their minimum. Neglect of these precautions may result in large noise bursts that may damage your equipment, your ears, or both.

④ INPUT GAIN knob 1/2

Adjusts the input signal level of the MIC/LINE/HI-Z 1/2. The adjustable range varies depending on the on/off setting of the PAD switch.

PAD	Range
On	-34 dB – +10 dB
Off	-60 dB – -16 dB

⑤ PHONES knob 1/2

Adjusts the output signal level of the PHONES 1/2. This output signal level is not affected by the OUTPUT LEVEL knob.

PHONES 1 outputs the MIX 1 signals. PHONE 2 outputs one of the MIX 1–3 signals. To select the output signal of the PHONES 2, use the “Headphone Area” (page 14) in the section “dspMixFx UR28M” or the “Headphones Window” (page 19) in the section “Dedicated Windows for Cubase Series.”

⑥ 2TR IN LEVEL knob

Adjusts the input signal level of the 2TR IN signal.

The input signal at 2TR IN flows only to MIX 1, and not to the computer.

⑦ 2TR IN ON button

Turns on (lit) and off (dark) the 2TR IN.

⑧ INPUT meter

Indicates the input signal level of the analog input jacks (MIC/LINE/HI-Z 1/2 or LINE INPUT 3/4).

Lamp	Description
<input type="radio"/> Red	Overload
<input type="radio"/> Amber	-3 dB or more
<input type="radio"/> Amber	-14 dB or more
<input type="radio"/> Green	-48 dB or more

To select which analog input jacks' levels are to be indicated, use the “Setup Window” (page 15) in the section “dspMixFx UR28M” or the “Settings Window” (page 20) in the section “Dedicated Windows for Cubase Series.”

⑨ OUTPUT meter

Indicates the output signal level of the LINE OUTPUT selected by the OUTPUT button A–C.

Lamp	Description
<input type="radio"/> Red	Overload
<input type="radio"/> Amber	-3 dB or more
<input type="radio"/> Amber	-14 dB or more
<input type="radio"/> Green	-48 dB or more

⑩ OUTPUT buttons A–C

For Alternate mode, this selects the particular LINE OUTPUT for output. For example, when you press OUTPUT button A, only LINE OUTPUT A will be selected for output, and OUTPUT button A will light.

For Independent mode, this selects the particular LINE OUTPUT for control. For example, when you press OUTPUT button A, LINE OUTPUT A will be selected for control, and OUTPUT button A will light.

For details on the mode, including how to select the mode, refer to the “Setup Window” (page 15) in the section “dspMixFx UR28M” or the “Master Levels Window” (page 20) in the section “Dedicated Windows for Cubase Series.”

⑪ SOURCE SELECT button

For Alternate mode, this selects the output signal (MIX 1–3) of the LINE OUTPUT.

For Independent mode, this selects the output signal (MIX 1–3) of the LINE OUTPUT selected by OUTPUT buttons A–C.

For details on the mode, including how to select the mode, refer to the “Setup Window” (page 15) in the section “dspMixFx UR28M” or the “Master Levels Window” (page 20) in the section “Dedicated Windows for Cubase Series.”

12 MIX 1–3 lamp

For Alternate mode, this indicates the output signal (MIX 1–3) of the LINE OUTPUT.

For Independent mode, this indicates the output signal (MIX 1–3) of the LINE OUTPUT selected by OUTPUT buttons A–C.

For details on the mode, including how to select the mode, refer to the “Setup Window” (page 15) in the section “dspMixFx UR28M” or the “Master Levels Window” (page 20) in the section “Dedicated Windows for Cubase Series.”

13 DIM button

Turns on (lit) and off (dark) the dimmer of all LINE OUTPUT signals.

When you turn on this button, the output signal level of all LINE OUTPUT will be attenuated by 20 dB. Turning on and off this button will not affect the output signal level of PHONES 1/2.

14 MONO MIX button

For Alternate mode, this turns on (lit) and off (dark) the mono mix for the output signal of the LINE OUTPUT.

For Independent mode, this turns on (lit) and off (dark) the mono mix for the output signal of the LINE OUTPUT selected by OUTPUT buttons A–C.

You can confirm the phase or mix balance of the sound by using this button.

For details on the mode, including how to select the mode, refer to the “Setup Window” (page 15) in the section “dspMixFx UR28M” or the “Master Levels Window” (page 20) in the section “Dedicated Windows for Cubase Series.”

15 OUTPUT LEVEL knob

Adjusts the output signal level of the LINE OUTPUT.

When you turn the LINK (page 15) off in the Independent mode, you can set different output signal levels to each LINE OUTPUT A–C. Press one of the OUTPUT buttons A–C then adjust the output signal level by the OUTPUT LEVEL knob. At this time, the OUTPUT LEVEL knob setting and the output signal level are mismatched immediately after you select the OUTPUT buttons A–C. When you adjust the OUTPUT LEVEL knob, the output signal level is applied immediately.

⚠ CAUTION

When you turn the LINK off, and set the a significant different signal level for each LINE OUTPUT A–C, a high volume level may be produced suddenly by turning the OUTPUT LEVEL knob, possibly causing hearing loss or device damage.

16 MUTE button

For Alternate mode, this turns on (lit) and off (dark) muting of the LINE OUTPUT signal.

For Independent mode, this turns on (lit) and off (dark) muting of the LINE OUTPUT signal selected by OUTPUT buttons A–C.

For details on the mode, including how to select the mode, refer to the “Setup Window” (page 15) in the section “dspMixFx UR28M” or the “Master Levels Window” (page 20) in the section “Dedicated Windows for Cubase Series.”

17 Power button

Turns the power on and off.

Power on Press the power button (⏻). The power button will light.

Power off Hold down the power button (⏻) for over one second. The power button will light dimly.

18 Word clock source lamp

Indicates the word clock (page 28) source of the device.

Lamp	Clock Source
S/PDIF	The word clock signal input to S/PDIF IN.
INTERNAL	The internal word clock signal.

Lamp status Description

Lit	Synchronized with the clock source.
Flash	Not synchronized with the clock source.

To select the clock source of the device, use the “(device name) Window” (page 9) in the section “Control Panel of the Audio Driver” in Windows or Audio MIDI Setup in Mac.

Panel Controls for the Software Programs

Control Panel of the Audio Driver

This is the control panel for selecting the general settings of the audio driver. Click the upper tabs to select the desired window.

Screenshot

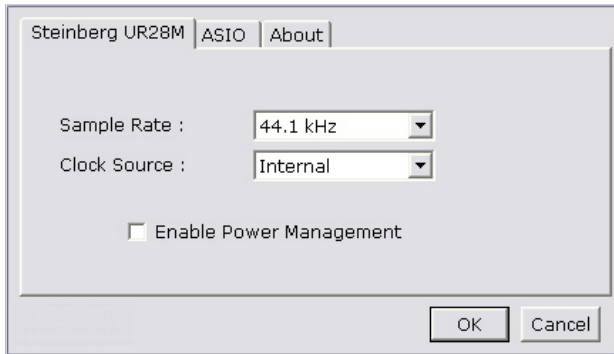

How to Open the Window

Windows

- [Start] → [Control Panel] → [Hardware and Sound] or [Sounds, Speech, and Audio Devices] → [Yamaha Steinberg USB Driver]
- From the Cubase series menu, [Devices] → [Device Setup] → [Yamaha Steinberg USB ASIO] → [Control Panel]

Mac

- [System Preferences] → [Yamaha Steinberg USB]
- From the Cubase series menu, [Devices] → [Device Setup] → [Steinberg UR28M] → [Control Panel] → [Open Config App]

Panel Controls

(Device name) Window

This is the window for selecting the sample rate or word clock source of the device.

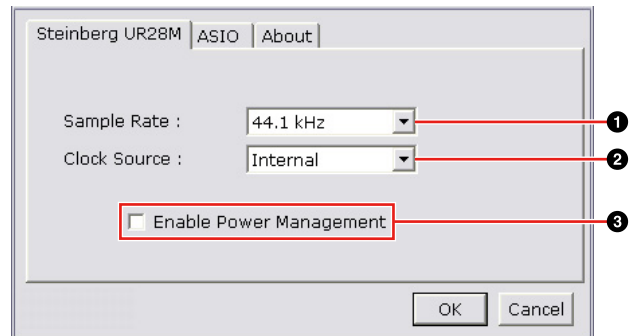

① Sample Rate (Windows only)

Selects the sample rate of the device.

Option: 44.1 kHz, 48 kHz, 88.2 kHz, 96 kHz

NOTE

For Mac, select the sample rate of the device via the Audio MIDI Setup.

② Clock Source (Windows only)

Selects the word clock source of the device.

Option	Clock Source
S/PDIF	The word clock signal input to S/PDIF IN.
Internal	The internal word clock signal.

NOTE

For Mac, select the word clock source of the device via the Audio MIDI Setup.

③ Enable Power Management

Select enable (checkmark) and disable (no checkmark) for automatic power off.

The device is equipped with an automatic power off function. When this function is enabled, the power of the device will turn off automatically (after thirty minutes) when one of the following actions is performed. The power button will flash during the thirty-minute interval.

- Turning off the computer.
- Disconnecting the USB cable between the device and the computer.

ASIO Window (Windows only)

This is the window for selecting the ASIO driver settings.

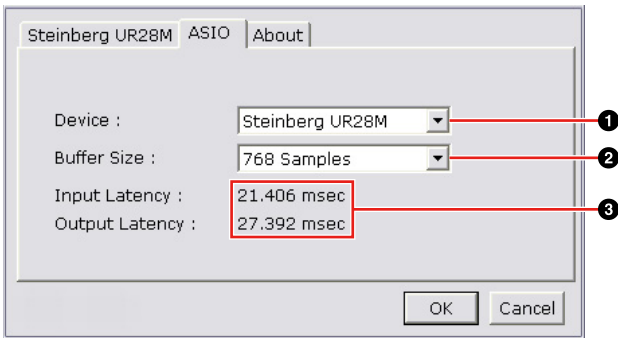

1 Device

Selects the device that will be using the ASIO driver. This function is available when connecting to the computer two or more devices compatible with the Yamaha Steinberg USB Driver.

2 Buffer Size

Selects the buffer size (page 28) for the ASIO driver. The range varies depending on the sample rate.

Sample Rate	Range
48 kHz or lower	64 samples – 2048 samples
88.2 kHz or higher	128 samples – 4096 samples

NOTE

For Mac, select the buffer size in the buffer size selecting window, which is opened from an application such as DAW software.

3 Input Latency/Output Latency

Indicates the delay time for the audio input and output in millisecond units.

Audio latency varies depending on the value of the ASIO buffer size. The lower the value of the ASIO buffer size, the lower the value of Audio latency.

About Window

This window indicates information about the audio driver.



1 About

Indicates the version and copyright of the audio driver. The letters “x.x.x” indicate the version number.

dspMixFx UR28M

This is the window for configuring the DSP mixer and DSP effect equipped with the device. The signals flow top-to-down and left-to-right. The dspMixFx UR28M provides stand-alone operation.

NOTE

You cannot operate the dspMixFx UR28M while a Cubase series DAW is running. When Cubase is running, configure the DSP mixer and DSP effect from “Dedicated Windows for Cubase Series” (page 16).

Screenshot



How to Open the Window

Windows

[Start] → [All Programs] → [Steinberg UR28M] → [dspMixFx UR28M]

Mac

[Macintosh HD] → [Applications] → [dspMixFx UR28M]

Panel Controls

Tool Area

This is the area for configuring the common settings of the dspMixFx UR28M.



1 Quit

Quits the dspMixFx UR28M.

2 Minimize

Minimizes the dspMixFx UR28M window.

3 Menu

Provides four menus, including Save the settings file of the dspMixFx UR28M (page 28) and Import Scene (page 28).

Menu	Description
Open	Opens the settings file of the dspMixFx UR28M.
Save	Saves the settings file of the dspMixFx UR28M to a computer.
Import Scene	Imports a scene from the settings file of the dspMixFx UR28M. Select the settings file of the dspMixFx UR28M and import scene on the left side of the IMPORT SCENE window. Select the destination for importing on the right side of the window. Click [OK] to import it.
Initialize All Scenes	Deletes all the saved scenes.

4 Scene

Indicates the scene name. You can change the scene name by clicking on it.

When you click the button on the right side, the window for calling up the scene will open. You can call up the scene by clicking it. To cancel calling up the scene, click outside of the window.

5 STORE

Opens the scene store window. Enter the desired scene name into the STORE NAME field. Select the destination for storing the scene in the No. NAME field. Click [OK] to store the scene.

6 Selecting the window

Selects the dspMixFx UR28M window. The selected window icon will light in red.

Icon	Description
	Main window (page 12)
	Setup window (page 15)
	Information window (page 16)

7 Help

Opens the Operation Manual (this manual).

Main Window

This is the window for configuring the entire signal flow.



Channel Area

This is the area for configuring the input channel settings.

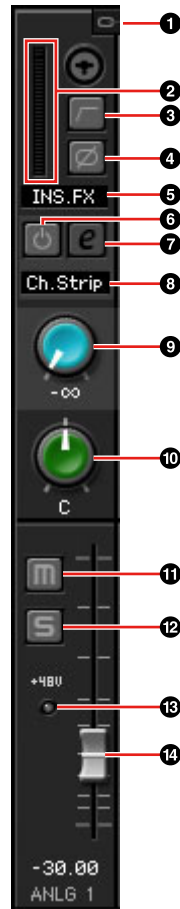

1 Channel Link

Turns on (lit) and off (dark) the channel link of two adjacent channels. When you turn this on, two mono channels will become one stereo channel.

2 Level Meter

Indicates the signal level.

3 High Pass Filter

Turns on (lit) and off (dark) the high pass filter.

To select the cutoff frequency of the high pass filter, use the “Setup Window” (page 15) in the section “dspMixFx UR28M.”

4 Phase

Turns on (lit) and off (dark) the phase inversion of the signal.

5 Channel Strip Insertion Location

Selects the insertion location of the Channel Strip.

Option	Description
MON.FX	Applies the Channel Strip to only the monitor signal (sent to the device).
INS.FX	Applies the Channel Strip to both the monitor signal (sent to the device) and the recording signal (sent to a DAW software).

6 Channel Strip On/Off

Turns the Channel Strip on (lit) and off (dark).

You can apply four Channel Strips to mono channels, or two Channel Strips to a stereo channel.

7 Channel Strip Edit

Opens (lit) and closes (dark) the “Channel Strip” (page 20) setup window.

8 Effect Type

Indicates the effect type.

9 REV-X Send

Adjusts the signal level which is sent to the REV-X.

Range: $-\infty$ dB – +6.00 dB

10 Pan

Adjusts the pan.

Range: L16 – C – R16

11 Mute

Turns the mute on (lit) and off (dark).

12 Solo

Turns the solo on (lit) and off (dark).

13 +48V

Indicates the on/off status of the phantom power function of the device.

14 Fader

Adjusts the signal level.

Range: $-\infty$ dB – +6.00 dB

DAW Area

This is the area for configuring the DAW channel settings.

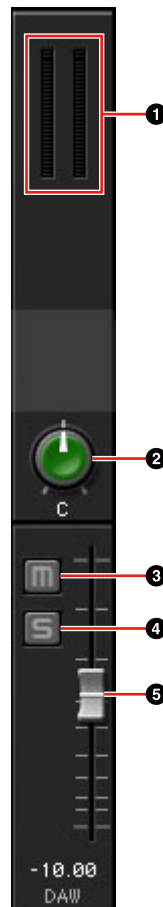

1 Level Meter

Indicates the signal level.

2 Pan

Adjusts the pan.

Range: L16 – C – R16

3 Mute

Turns the mute on (lit) and off (dark).

4 Solo

Turns the solo on (lit) and off (dark).

5 Fader

Adjusts the signal level.

Range: $-\infty$ dB – +6.00 dB

Master Area

This is the area for configuring the master channel settings.

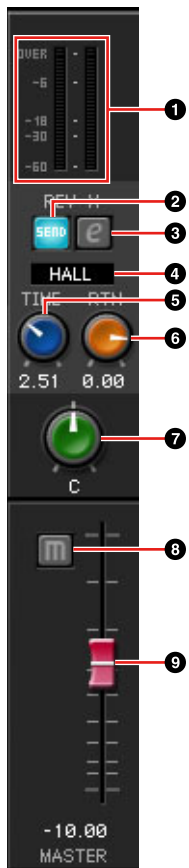

1 Level Meter

Indicates the signal level.

2 REV-X Send On/Off

Turns the REV-X on (lit) and off (dark).

You can turn this on for one of MIX 1–3.

3 REV-X Edit

Opens (lit) and closes (dark) the “REV-X” (page 23) setup window.

4 REV-X Type

Selects the REV-X type.

Option: Hall, Room, Plate

5 REV-X Time

Adjusts the reverb time of the REV-X. This parameter links to Room Size. The adjustable range varies depending on the REV-X type.

REV-X type	Range
Hall	0.103 sec – 31.0 sec
Room	0.152 sec – 45.3 sec
Plate	0.176 sec – 52.0 sec

6 REV-X Return Level

Adjusts the return level of the REV-X.

Range: -∞ dB – +6.00 dB

7 Pan

Adjusts the pan.

Range: L16 – C – R16

8 Mute

Turns the mute on (lit) and off (dark).

9 Fader

Adjusts the signal level.

Range: -∞ dB – +6.00 dB

MIX Area

This is the area for selecting the MIX you want to configure.



1 MIX

Selects the MIX you want to configure.

You can copy the Main window settings of the MIX by dragging and dropping.

Headphone Area

This is the area for selecting the output signal of the headphone. (PHONES 2 only)



1 PHONES On/Off

Turns on (lit) and off (dark) the headphone. You can output the MIX selected in the MIX area to the PHONES by turning this on.

Setup Window

This is the window for configuring the common settings of the device.

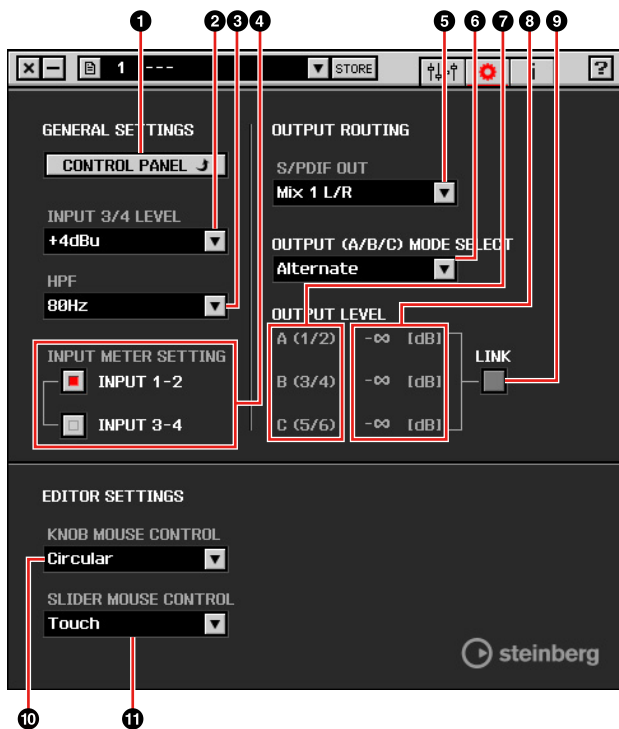

1 CONTROL PANEL

For Windows, this opens the “Control Panel of the Audio Driver” (page 9). For Mac, this opens the Audio MIDI Setup.

2 INPUT 3/4 LEVEL

Selects the input signal level of LINE INPUT 3/4.

Option: +4dBu, -10dBV

3 HPF

Selects the cutoff frequency of the high pass filter.

Option: 120 Hz, 100 Hz, 80 Hz, 60 Hz, 40 Hz

4 Input Meter Setting

Selects the analog input jacks whose input signal levels are indicated on the INPUT meter on the device.

Option	Description
INPUT 1-2	Indicates the input signals of MIC/LINE/HI-Z 1/2.
INPUT 3-4	Indicates the input signals of LINE INPUT 3/4.

5 S/PDIF OUT

Selects the output signal of the S/PDIF OUT.

6 OUTPUT (A/B/C) MODE SELECT

Selects the function (mode) of the LINE OUTPUT A–C.

There are two modes, Alternate and Independent.

Mode	Description
Alternate	One of the LINE OUTPUTS A–C selected by the OUTPUT buttons A–C outputs a single MIX signal selected by the SOURCE SELECT button.
Independent	The LINE OUTPUTS A–C output each MIX selected by the SOURCE SELECT button at the same time.

7 Master Source

Indicates the LINE OUTPUT.

8 Master Level

Indicates the output signal level of the LINE OUTPUT.

9 LINK (Independent mode only)

Lets you enable (checkmark) or disable (no checkmark) the function which adjusts the level of all LINE OUTPUT signals by the OUTPUT LEVEL knob on the device at the same time.

For instructions on how to adjust the output signal level with LINK disabled, refer to the “OUTPUT LEVEL knob” (page 8) in the section “Panel Controls and Terminals (Details).”

10 KNOB MOUSE CONTROL

Selects the method of operating the knobs on the dspMixFx UR28M.

Option	Description
Circular	Drag in a circular motion to increase and decrease the parameter. Drag in a dial clockwise to increase, and counterclockwise to decrease. If you click any point on the knob, the parameter will jump there instantly.
Linear	Drag in a linear motion to increase and decrease the parameter. Drag to the upward or rightward to increase, and downward or leftward to decrease. Even if you click any point on the knob, the parameter will not jump there.

11 SLIDER MOUSE CONTROL

Selects the method of operating the sliders and faders on the dspMixFx UR28M.

Option	Description
Jump	Click any point on the slider and fader to increase and decrease the parameter. If you click any point on the slider and fader, the parameter will jump there instantly.
Touch	Drag the handle of the slider and fader to increase and decrease the parameter. Even if you click any point on the slider and fader, the parameter will not jump there.

Information Window

This window indicates information about the dspMixFx UR28M and the device.



1 Version Information

Indicates the version of the firmware and software. The letters “x.x.x” and “x.xx” indicate the version number.

2 Check for update

Checks whether or not you have the latest software and firmware version, via the Internet. If a new version is found, follow the on-screen instructions for updating.

Dedicated Windows for Cubase Series

These are the windows for configuring the device settings from Cubase series. The Dedicated Windows for Cubase series allow you to configure the parameters which are configured by the dspMixFx UR28M. from Cubase series. Two types of windows are available: Input Settings and Hardware Setup.

Input Settings Window

This is the window for configuring the input settings of the device. The signal flow is from top to bottom. The settings on this window are saved to the Cubase project file, except for the +48V indicator.

Hardware Setup Window

This is the window for configuring the general settings of the device. Click the upper tabs to select the window. Only the settings on the Reverb Routing window are saved to the Cubase project file.

Screenshot

Input Settings Window



Hardware Setup Window

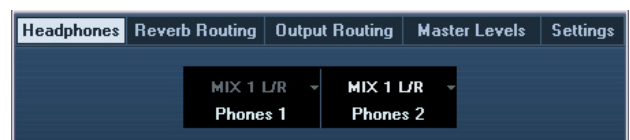

How to Open the Window

Input Settings Window

The Input Settings window appears in the following windows.

- In the Mixer window (Cubase and Cubase Artist only)
- In the VST Input Channel Settings window (Cubase and Cubase Artist only)
- In the VST Audio Channel Settings window (other Cubase series software)

In the Mixer Window (Cubase and Cubase Artist only)

1. [Devices] → [Mixer] to open the Mixer window.
2. Click “Show Extended View.”

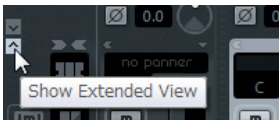

3. Click “Extended View Type/Can Hide State” in the input channel.

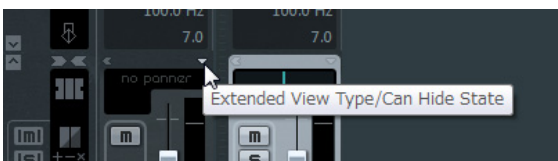

4. Click [Hardware].

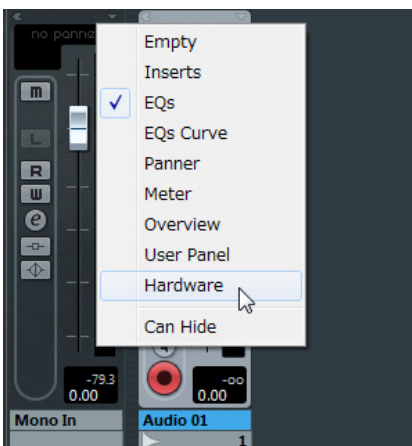

The Input Settings window appears in the Mixer window as shown below.



In the VST Input Channel Settings Window (Cubase and Cubase Artist only)

1. [Devices] → [Mixer] to open the mixer.
2. Click “Edit Input Channel Settings” in the input channel.



The Input Settings window appears in the VST Input Channel Settings window as shown below.



In the VST Audio Channel Settings Window (other Cubase series software)

1. Click the audio track from the track list.



2. Click “Edit Channel Settings” in the audio track.

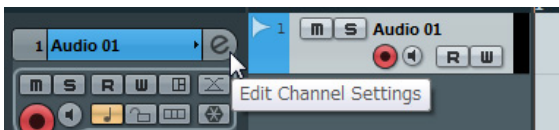

The Input Settings window appears in the VST Audio Channel Settings window as shown below.

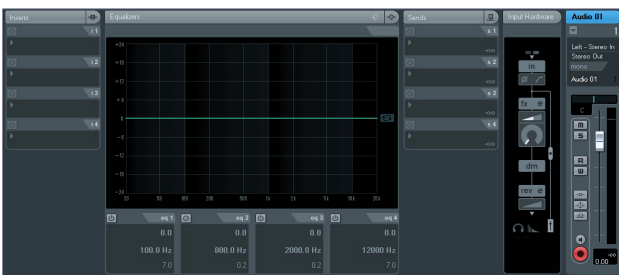

Hardware Setup Window

[Devices] → [Audio Hardware Setup]

Panel Controls

Input Settings Window

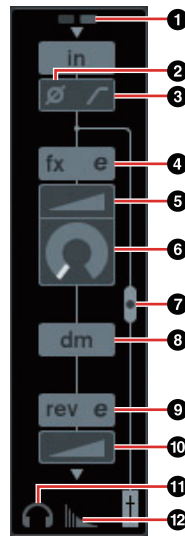

- 1 +48V**
Indicates the on/off status of the phantom power function of the device.
- 2 Phase**
Turns on (lit) and off (dark) the phase inversion of the signal.
- 3 High Pass Filter**
Turns on (lit) and off (dark) the high pass filter.

To select the cutoff frequency of the high pass filter, use the “Settings Window” (page 20) in the section “Dedicated Windows for Cubase Series.”
- 4 Channel Strip Edit**
Opens the “Channel Strip” (page 20) setup window.
- 5 DRIVE**
Adjusts the degree to which the compressor is applied. The higher the value, the greater the effect.
Range: 0.00 – 10.00
- 6 MORPH**
Adjusts the Channel Strip Sweet Spot Data. (Refer to the “MORPH” in the section “Channel Strip” on page 20.)

7 Channel Strip Insertion Location

Selects the insertion location of the Channel Strip.

Insertion location	Description
Upper (OFF)	Channel Strip is not applied.
Middle (MON.FX)	Applies the Channel Strip to only the monitor signal (sent to the device).
Lower (INS.FX)	Applies the Channel Strip to both the monitor signal (sent to the device) and the recording signal (sent to the DAW software).

You can apply four Channel Strips to mono channels, or two Channel Strips to a stereo channel.

8 Output Position of the Direct Monitoring Signal

Indicates the position from which the audio signals for monitoring will be output when turning on Direct Monitoring in the device settings on Cubase.

9 REV-X Edit

Opens the “REV-X” (page 23) setup window.

10 REV-X Send

Adjusts the signal level which is sent to the REV-X.

Range: -∞ dB – +6.00 dB

11 Headphones Edit

Opens the “Headphones Window” (page 19) in the section “Dedicated Windows for Cubase Series.”

12 Reverb Routing Edit

Opens the “Reverb Routing Window” (page 19) in the section “Dedicated Windows for Cubase Series.”

Hardware Setup Window

Headphones Window

This is the window for selecting the output signal of the PHONES on the device. (PHONES 2 only)



1 Phones 1

Indicates the output signal of PHONES 1.

2 Phones 2

Selects the output signal of PHONES 2.

Reverb Routing Window

This is the window for configuring the “REV-X” (page 23) settings.

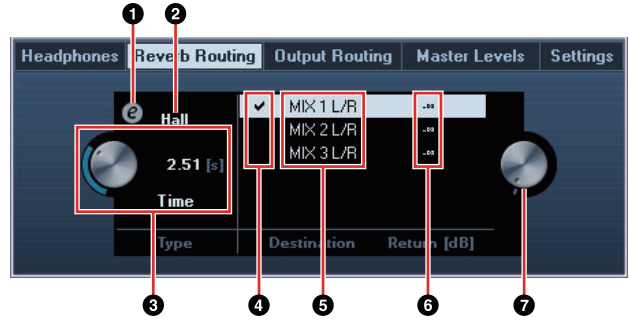

1 REV-X Edit

Opens the “REV-X” (page 23) setup window.

2 REV-X Type

Selects the REV-X type.

Option: Hall, Room, Plate

3 REV-X Time

Adjusts the reverb time of the REV-X. This parameter links to Room Size. The adjustable range varies depending on the REV-X type.

REV-X type	Range
Hall	0.103 sec – 31.0 sec
Room	0.152 sec – 45.3 sec
Plate	0.176 sec – 52.0 sec

4 REV-X Send Source Select

Selects the send source signal which is sent to the REV-X. You can select one signal at a time. The checkmark will be on the selected signal.

5 REV-X Send Source

Indicates the signal which is sent to the REV-X.

6 REV-X Return Level

Indicates the return level of the REV-X.

7 REV-X Return Level knob

Adjusts the return level of the selected (highlighted) signal.

Range: -∞ dB – +6.00 dB

Output Routing Window

This is the window for selecting the output signal of the output jacks on the device.

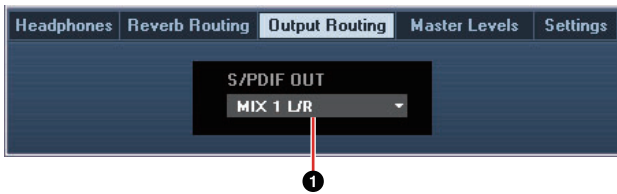

1 S/PDIF OUT

Selects the output signal of the S/PDIF OUT.

Master Levels Window

This is the window for configuring the master level of the output jacks on the device.

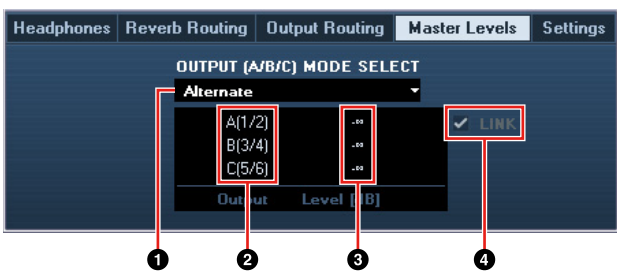

1 OUTPUT (A/B/C) MODE SELECT

Selects the function (mode) of the LINE OUTPUT A–C. There are two modes, Alternate and Independent.

Mode	Description
Alternate	One of the LINE OUTPUTS A–C selected by the OUTPUT buttons A–C outputs a single MIX signal selected by the SOURCE SELECT button.
Independent	The LINE OUTPUTS A–C output each MIX selected by the SOURCE SELECT button at the same time.

2 Master Source

Indicates the LINE OUTPUT.

3 Master Level

Indicates the output signal level of the LINE OUTPUT.

4 LINK (Independent mode only)

Lets you enable (checkmark) or disable (no checkmark) the function which adjusts the level of all LINE OUTPUT signals by the OUTPUT LEVEL knob on the device at the same time.

For instructions on how to adjust the output signal level with LINK disabled, refer to the “OUTPUT LEVEL knob” (page 8) in the section “Panel Controls and Terminals (Details).”

Settings Window

This is the window for configuring the device settings.

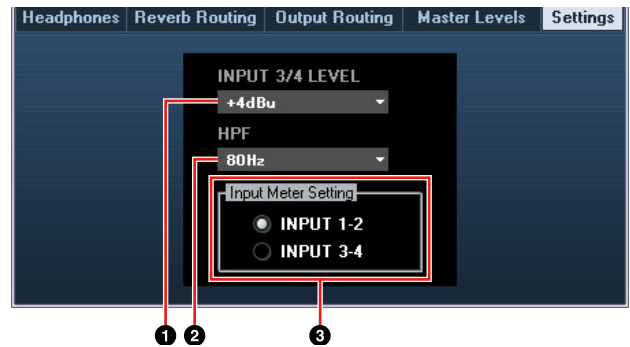

1 INPUT 3/4 LEVEL

Selects the input signal level of LINE INPUT 3/4.

Option: +4dBu, -10dBV

2 HPF

Selects the cutoff frequency of the high pass filter.

Option: 120 Hz, 100 Hz, 80 Hz, 60 Hz, 40 Hz

3 Input Meter Setting

Selects the analog input jacks whose input signal levels are indicated on the INPUT meter on the device.

Option	Description
INPUT 1-2	Indicates the input signals of MIC/ LINE/HI-Z 1/2.
INPUT 3-4	Indicates the input signals of LINE INPUT 3/4.

Sweet Spot Morphing Channel Strip (Channel Strip)

This is the window for configuring the Channel Strip settings.

NOTE

- The Channel Strip equipped with the device and the Channel Strip of the VST Plug-in version have the same parameters.

- When using the Channel Strip on Cubase series programs, you can share the settings between the built-in Channel Strip and the Channel Strip of the VST Plug-in version as a preset file.
- When using the built-in Channel Strip on Cubase series programs, turn on the “Direct Monitoring” setting in the program.
- When assigning the Channel Strip of the VST Plug-in version to the effect slot on Cubase series programs, select it from the “Dynamics” category (in the case of the default settings).

Screenshot



How to Open the Window

From Dedicated Windows for Cubase Series

Click “Channel Strip Edit” (page 18) in the section “Input Settings Window.”

From the dspMixFx UR28M

Click “Channel Strip Edit” (page 13) in the section “Channel Area.”

Panel Controls

Common to Compressor and Equalizer



1 MORPH

Adjusts the parameter of the Sweet Spot Data.

You can simultaneously adjust the compressor and equalizer settings which are set to five points around this knob by turning this knob. When you set the knob to the middle of adjacent two points, the compressor and equalizer settings will be set to an intermediate value.

2 Sweet Spot Data

Selects the Sweet Spot Data (page 28).

3 TOTAL GAIN

Adjusts the total gain of the Channel Strip.

Range: -18.0 dB – +18.0 dB

4 Level Meter

Indicates the output level of the Channel Strip.

Compressor



1 ATTACK

Adjusts the attack time of the compressor.

Range: 0.092 msec – 80.00 msec

2 RELEASE

Adjusts the release time of the compressor.

Range: 9.3 msec – 999.0 msec

3 RATIO

Adjusts the ratio of the compressor.

Range: 1.00 – ∞

4 KNEE

Selects the knee type of the compressor.

Option	Description
SOFT	Produces the most gradual change.
MEDIUM	Middle setting between SOFT and HARD.
HARD	Produces the sharpest change.

5 SIDE CHAIN Q

Adjusts the band width of the side chain filter (page 28).

Range: 0.50 – 16.00

6 SIDE CHAIN F

Adjusts the center frequency of the side chain filter.

Range: 20.0 Hz – 20.0 kHz

7 SIDE CHAIN G

Adjusts the gain of the side chain filter.

Range: -18.0 dB – +18.0 dB

8 COMPRESSOR On/Off

Turns the compressor on (lit) and off (dark).

9 Compressor Curve

This graph indicates the approximate compressor response. The vertical axis indicates the output signal level, and the horizontal axis indicates the input signal level.

10 Gain Reduction Meter

Indicates the gain reduction.

11 DRIVE

Adjusts the degree to which the compressor is applied. The higher the value, the greater the effect.

Range: 0.00 – 10.00

Equalizer

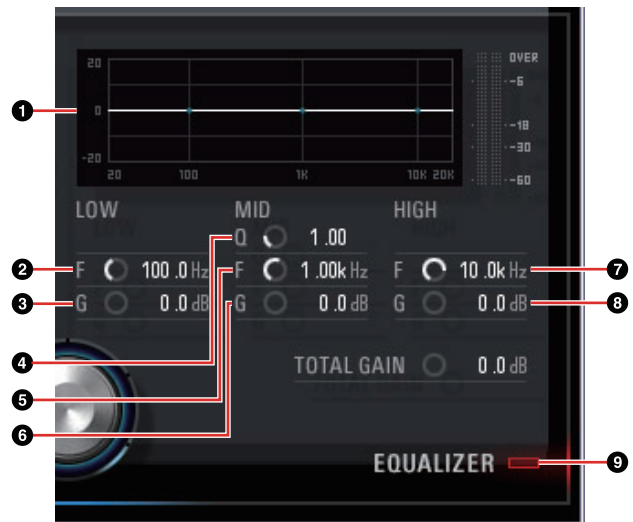

1 Equalizer Curve

This graph indicates the characteristics of the 3-band equalizer. The vertical axis indicates the gain, and the horizontal axis indicates the frequency. You can adjust LOW, MID, and HIGH by dragging each handle in the graph.

2 LOW F

Adjusts the center frequency of the low band.

Range: 20.0 Hz – 1.00 kHz

3 LOW G

Adjusts the gain of the low band.

Range: -18.0 dB – +18.0 dB

4 MID Q

Adjusts the band width of the middle band.

Range: 0.50 – 16.00

5 MID F

Adjusts the center frequency of the middle band.

Range: 20.0 Hz – 20.0 kHz

6 MID G

Adjusts the gain of the middle band.

Range: -18.0 dB – +18.0 dB

7 HIGH F

Adjusts the center frequency of the high band.

Range: 500.0 Hz – 20.0 kHz

8 HIGH G

Adjusts the gain of the high band.

Range: -18.0 dB – +18.0 dB

9 EQUALIZER On/Off

Turns the equalizer on (lit) and off (dark).

REV-X

This is the window for configuring the REV-X settings. Three types of REV-X are available: Hall, Room, and Plate.

NOTE

- The REV-X equipped with the device and REV-X of the VST Plug-in version have the same parameters. However, the “OUTPUT” and “MIX” parameters are only available in the VST Plug-in version.
- When using the REV-X on Cubase series programs, you can share the settings between the built-in REV-X and the REV-X of the VST Plug-in version as a preset file.
- When using the built-in REV-X on Cubase series programs, turn on the “Direct Monitoring” setting in the program.
- When assigning the REV-X of the VST Plug-in version to the effect slot on Cubase series programs, select it from the “Reverb” category (in the case of the default settings).
- The built-in REV-X is equipped with an “FX Bus” which is used for sending the signal from DAW software to the REV-X. For example, to send the recorded audio data to the REV-X, you can check the sound with the REV-X, which is used for monitoring during the recording.

Screenshot

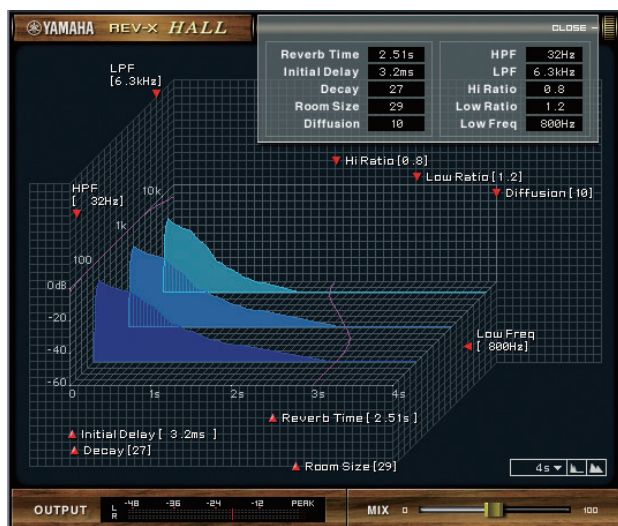

How to Open the Window

From Dedicated Windows for Cubase Series

- Click “REV-X Edit” (page 19) in the section “Input Settings Window.”

- Click “REV-X Edit” (page 19) in the section “Reverb Routing Window.”

From the dspMixFx UR28M

Click “REV-X Edit” (page 14) in the section “Master Area.”

Panel Controls

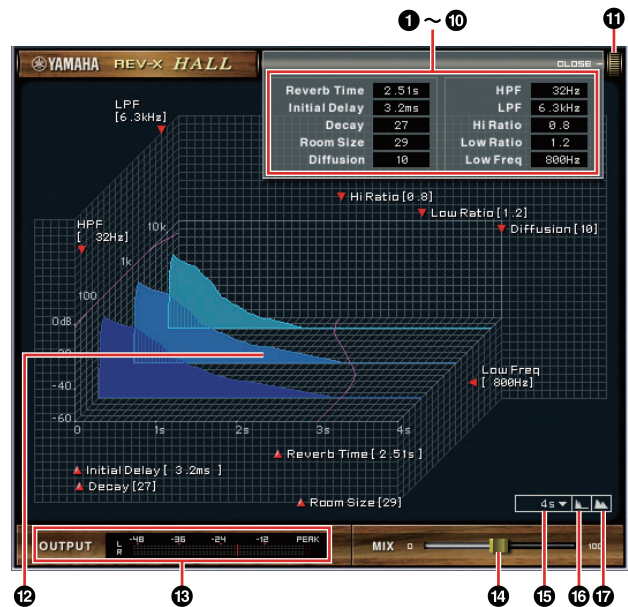

NOTE

This section uses the Hall type of REV-X as an example.

① Reverb Time

Adjusts the reverb time. This parameter links to Room Size. The adjustable range varies depending on the REV-X type.

REV-X type Range

Hall	0.103 sec – 31.0 sec
Room	0.152 sec – 45.3 sec
Plate	0.176 sec – 52.0 sec

② Initial Delay

Adjusts the time that elapses between the direct, original sound and the initial reflections that follow it.

Range: 0.1 msec – 200.0 msec

③ Decay

Adjusts the characteristic of the envelope from the moment the reverberation starts to the moment it attenuates and stops.

Range: 0 – 63

4 Room Size

Adjusts the size of the simulated room. This parameter links to Reverb Time.

Range: 0 – 31

5 Diffusion

Adjusts the spread of the reverberation.

Range: 0 – 10

6 HPF

Adjusts the cutoff frequency of the high pass filter.

Range: 20 Hz – 8.0 kHz

7 LPF

Adjusts the cutoff frequency of the low pass filter.

Range: 1.0 kHz – 20.0 kHz

8 Hi Ratio

Adjusts the duration of reverberation in the high frequency range by using a ratio relative to the Reverb Time. When you set this parameter to 1, the actual specified Reverb Time is fully applied to the sound. The lower the value, the shorter the duration of reverberation in the high frequency range.

Range: 0.1 – 1.0

9 Low Ratio

Adjusts the duration of reverberation in the low frequency range by using a ratio relative to the Reverb Time. When you set this parameter to 1, the actual specified Reverb Time is fully applied to the sound. The lower the value, the shorter the duration of reverberation in the low frequency range.

Range: 0.1 – 1.4

10 Low Freq

Adjusts the frequency of the Low Ratio.

Range: 22.0 Hz – 18.0 kHz

11 OPEN/CLOSE

Opens and closes the window which adjusts the reverb settings.

12 Graph

Indicates the characteristics of reverberation. The vertical axis indicates the signal level, the horizontal axis indicates the time, and the Z-axis indicates the frequency. You can adjust the characteristics of reverberation by dragging the handles in the graph.

13 OUTPUT (VST Plug-in version only)

Indicates the output level of the REV-X.

14 MIX (VST Plug-in version only)

Adjusts the output level balance between the original sound and effect sound.

Range: 0% – 100%

15 Time Axis Setting

Select the display range of the time (horizontal axis) on the graph.

Display range: 500 msec – 50 sec

16 Zoom Out

Zooms out the display range of the time (horizontal axis) on the graph.

17 Zoom In

Zooms in the display range of the time (horizontal axis) on the graph.

TIPS

- You can reset some parameters to the default value by holding the [Ctrl]/[command] key while you click on the knobs, sliders, and faders.
- You can adjust the parameters more finely by holding the [SHIFT] key while you drag on the knobs, sliders, and faders.

Usage Examples

Introduction

This section introduces some usage examples of the device. It is assumed that the audio driver settings on the DAW software have been properly configured according to the “Basic Operation” section in the included Getting Started manual. If you have not configured them yet, refer to the section “Basic Operation” to complete the configuration.

Recording with the Channel Strip and REV-X

This section shows how to record a vocal to DAW software using the built-in Channel Strip and REV-X on the device. When using Cubase series programs, it is handy to use the project template. These project templates include the settings of the Channel Strip and REV-X. You can start recording instantly by opening the project template. When using programs other than the Cubase series, use the dspMixFx UR28M.

Connection Example

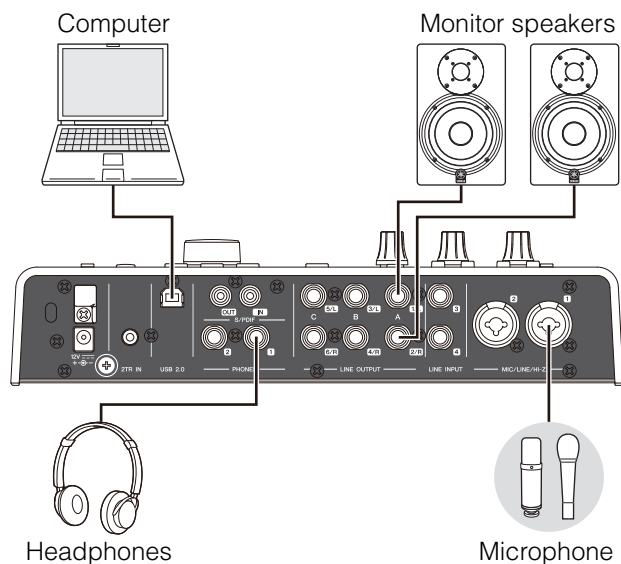

Operation

Cubase Series Programs

1. Launch the Cubase series DAW.

The Project Assistant window appears.

2. Select the project template “Steinberg UR28M Vocal-Inst Recording 1” in “Recording” on the Project Assistant window, then click [Create].

3. Turn on Direct Monitoring as follows.

[Devices] → [Device Setup] → [Yamaha Steinberg USB ASIO] (Windows) or [Steinberg UR28M] (Mac) → enter checkmark to “Direct Monitoring” → [OK]

4. Confirm that the “Record Enable” and “Monitor” indicators are turned on (lit) for the audio track.



5. While singing into the microphone, adjust the input signal level of the microphone by the INPUT GAIN knob on the device.

Adjust the input signal level so that the red lamp in the INPUT meter does not light.

6. While singing into the microphone, adjust the output signal level of the headphones by the PHONES knob on the device.

7. Set the Channel Strip settings and REV-X settings on the Input Settings window.

Select the Channel Strip Insertion Location depending on the desired insert point. The default setting is “Lower” (applied to both the monitor signal and the recording signal). For details on the Insertion Location, refer to the “Channel Strip Insertion Location” (page 19) in the section “Dedicated Windows for Cubase Series.”

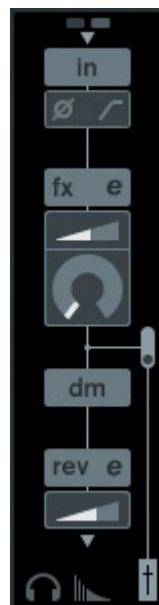

- Click “Record” to start the recording.



- After finishing the recording, click “Stop” to stop it.



- Turn “Monitor” off (dark) for the audio track.



- Click the Ruler to move the project cursor to the desired point for starting playback.

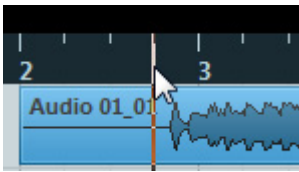

- Click “Play” to check the recorded sound.



When listening to the sound over monitor speakers, adjust the output signal level by the OUTPUT LEVEL knob on the device.

Operation is now completed.

Programs Other Than Cubase Series

- Launch your DAW software.
- Open the dspMixFx UR28M.
For instructions on how to open the dspMixFx UR28M, refer to the section “How to Open the Window” (page 11).
- Adjust the input signal level of the microphone by the INPUT GAIN knob on the device.

Adjust the input signal level so that the red lamp in the INPUT meter does not light.

- Adjust the output signal level of the headphone by the PHONES knob on the device.
- Set the Channel Strip settings and REV-X settings on the dspMixFx UR28M.



- Start recording on your DAW software.
- After finishing recording, stop it.
- Playback the newly recorded sound to check it.

Operation is now completed.

Controlling the Monitor Sound

This section shows how to control the monitor sound by using the buttons and knobs on the device.

Connection Example

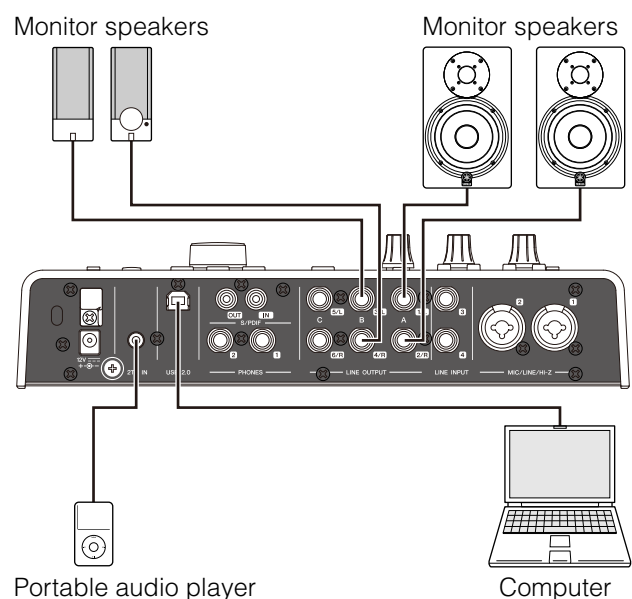

Operation

1. Play back some music with your DAW software or music player.
2. Control the monitor sound by using the following buttons and knobs.

OUTPUT button A–C

OUTPUT LEVEL knob

MUTE button

MONO MIX button

DIM button

For details on the buttons and knobs, refer to the “Front Panel” (page 6) in the section “Panel Control and Terminals (Details).”

The procedures are now complete.

Procedures

1. Connect the device to a computer with a USB cable.
2. Turn on the device.
3. Open the dspMixFx UR28M.
For instructions on opening the dspMixFx UR28M, refer to the “How to Open the Window” (page 11) in the section “dspMixFx UR28M.”
4. Configure the DSP mixer and DSP effect settings.
5. When you make the settings, click [X] on the upper left of the window to close the dspMixFx UR28M.

The settings of the dspMixFx UR28M are saved to the device.

The operation is now complete.

Using the Device Without a Computer

This section shows how to use the device without a computer, allowing you to use it as a standalone mixer or A/D - D/A converter. You can save the DSP mixer and DSP effect settings configured by the dspMixFx UR28M to the device. These settings are maintained even if you turn off the power of the device.

Connection Example

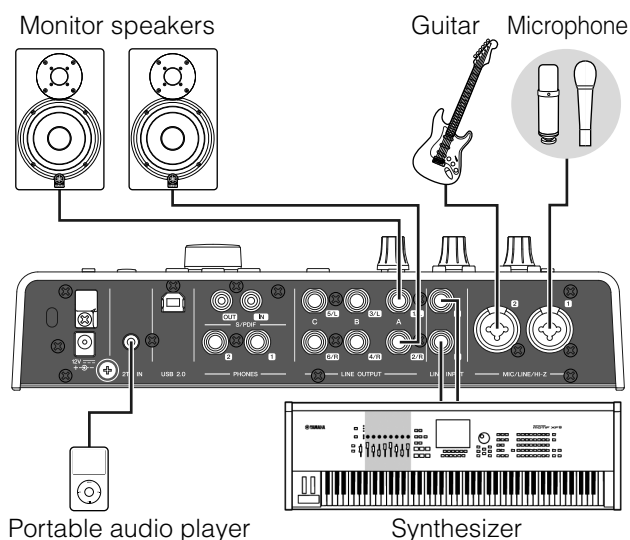

Appendix

Glossary

MIX

MIX refers to the stereo output signals which flow in the device. The input signals to the device flow to each MIX. You can assign any MIX to any analog output jack or any digital output jack.

VST Plug-in

VST (Virtual Studio Technology) is a technology developed by Steinberg which allows the integration of virtual effect processors and instruments into your digital audio environment. VST Plug-ins are instrument- and effect-based software of VST format. When you install a VST Plug-in to your computer, it will work on any DAW software compatible with VST Plug-ins, such as Cubase series.

DAW (Digital Audio Workstation)

DAW is an integrative system of music production, which lets you record and edit digital audio data. DAW software programs are applications which allow you to build such comprehensive systems on a computer.

Word Clock

Word clock synchronizes the process timing of audio signals when transferring digital audio data between multiple devices. Normally, one device transmits a reference word clock signal, and the other devices receive this word clock signal and synchronize to it. If the word clock signal is not transferred correctly, click noise may occur or recording may not be successful, even if the sample rates of the various devices are set to the same value.

Buffer Size

Buffer size refers to the amount of memory used to temporarily hold data during playback and recording. It is recommended to adjust the buffer size depending on the situation. Normally, a higher buffer size reduces load to the computer CPU but produces latency (time lag). Smaller buffer sizes reduce latency but produce greater load to the computer CPU. This high load to the computer CPU may result in noise or the sound cutting off.

Scene

A Scene is stored data which maintains the settings on the Main window of dspMixFx UR28M. You can recall the stored Scene in dspMixFx UR28M, and up to 20 Scenes can be stored.

Settings file of the dspMixFx UR28M

The settings file of the dspMixFx UR28M is a data file including up to 20 scenes which can be saved to your computer. You can load the dspMixFx UR28M settings file to the dspMixFx UR28M.

Sweet Spot Data

Sweet Spot Data are preset settings data of the Sweet Spot Morphing Channel Strip created by top-class engineers. This data includes the settings for the compressor and equalizer which are saved to each five points around the MORPH knob.

Side Chain Filter

The side chain filter is a peaking filter which adjusts the frequency range to which the compressor is applied. It features Q (band width), F (center frequency), and G (gain) parameters. For example, if the compressor reduces the audio signal level excessively because only the specified frequency of the audio signal is at a high level (and other frequencies are lower), you can selectively lower the level of the specified frequency by using this peaking filter. This will prevent the compressor from excessive level reduction.

Contents of the Getting Started Section

PRECAUTIONS

Introduction

- A Message from the Development Team
- Included Accessories
- How to Read the Manual

Panel Controls and Terminals

- Rear Panel
- Front Panel

Setup

1. Setting up the Power Supply
2. Installing Cubase AI
3. Installing TOOLS for UR28M
4. Downloading the Licenses (Activation)

Basic Operations

- Introduction
- Connection Example
- Configuring Audio Driver Settings on the DAW Software

Troubleshooting

Appendix

- Contents of the Operation Manual
- Uninstalling TOOLS for UR28M
- Specifications

Signal Flow

The following chart indicates the signal flow in the device.

NOTE

- The controllers on the device, such as the HI-Z switch, INPUT GAIN knob, and OUTPUT LEVEL knob, are not included in this chart.
- To configure each parameter, use the “dspMixFx UR28M” (page 10) or “Dedicated Windows for Cubase Series” (page 16).

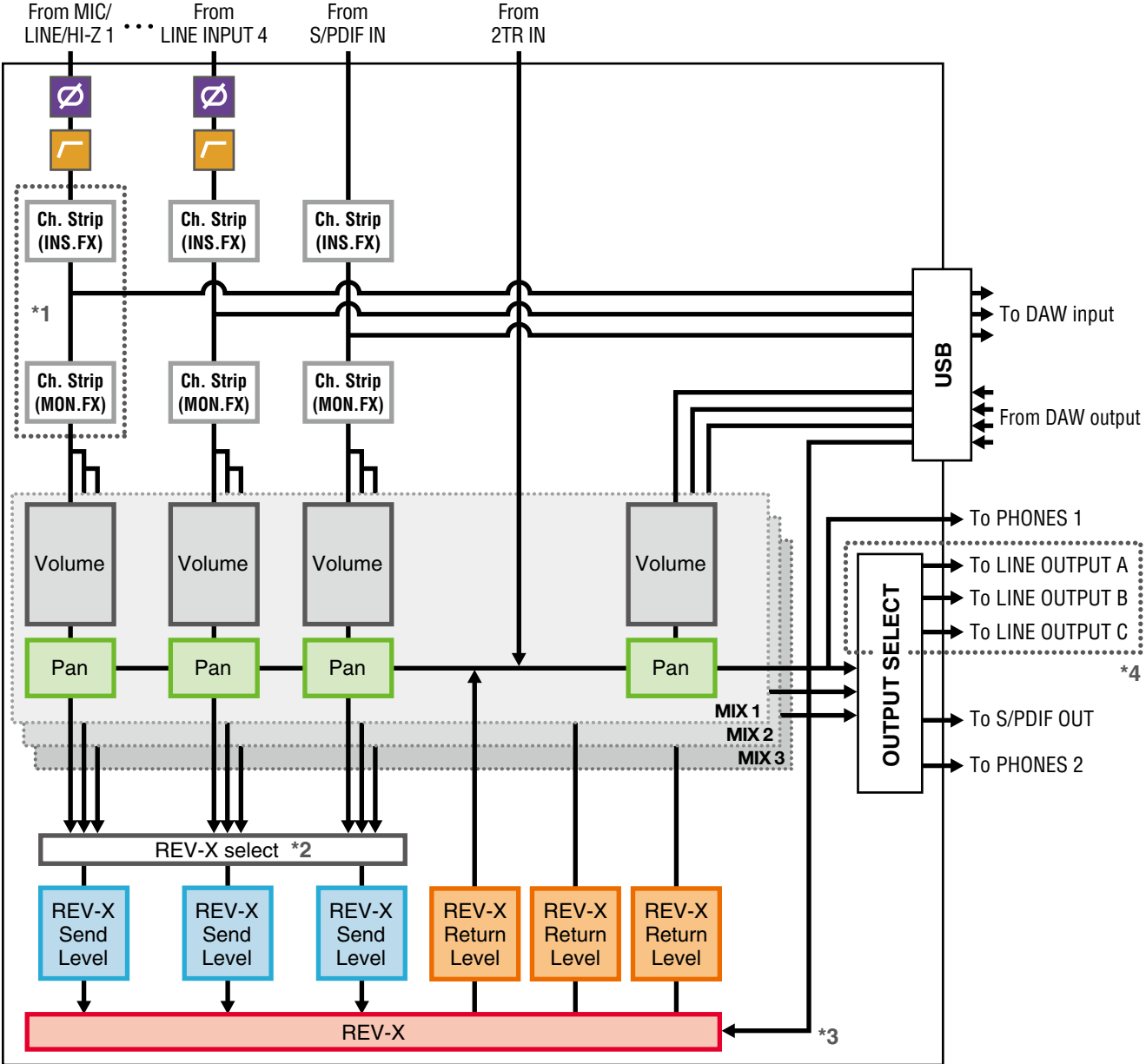

*1The following chart indicates the Ch.Strip (Channel Strip) insertion location.

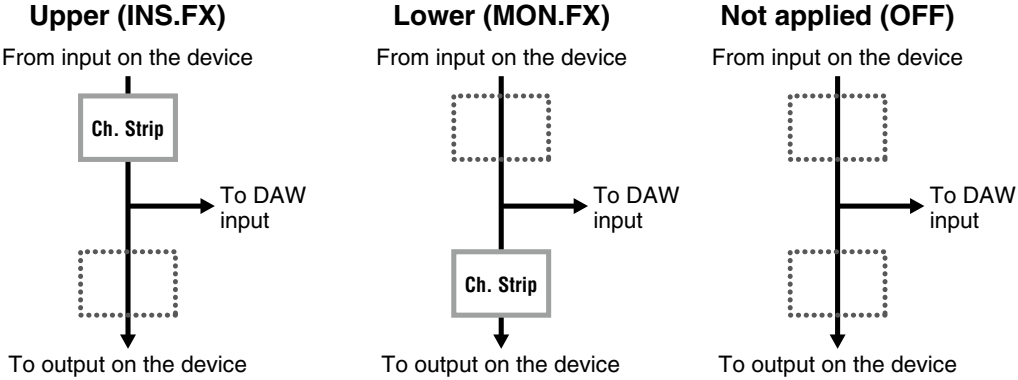

You can apply four Channel Strips to mono channels, or two Channel Strips to a stereo channel.

*2 One of the MIX 1–3 signals can be sent to the REV-X.

*3 The built-in REV-X is equipped with an “FX Bus” which is used for sending the signal from DAW software to the REV-X. For example, to send the recorded audio data to the REV-X, you can check the sound with the REV-X, which is used for monitoring during the recording.

*4 To select the output signal for LINE OUTPUT A–C, use the buttons on the device . The following charts indicate the structures.

Alternate mode

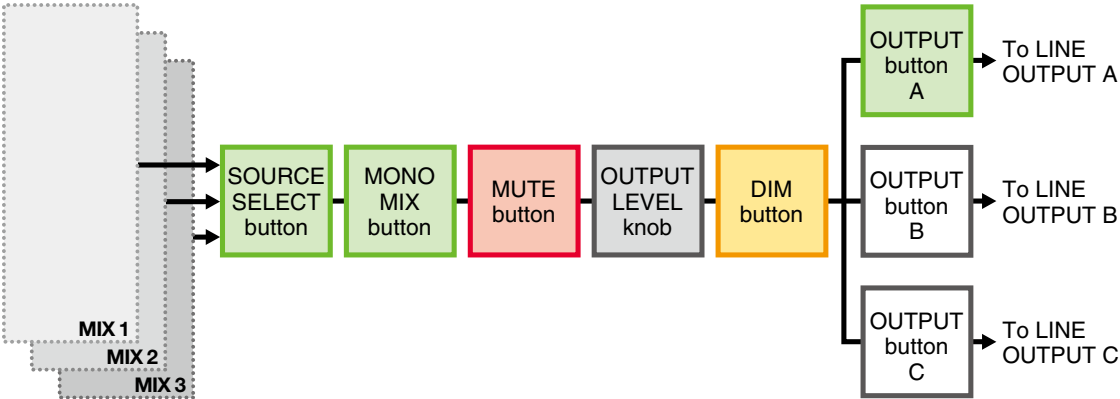

Independent mode

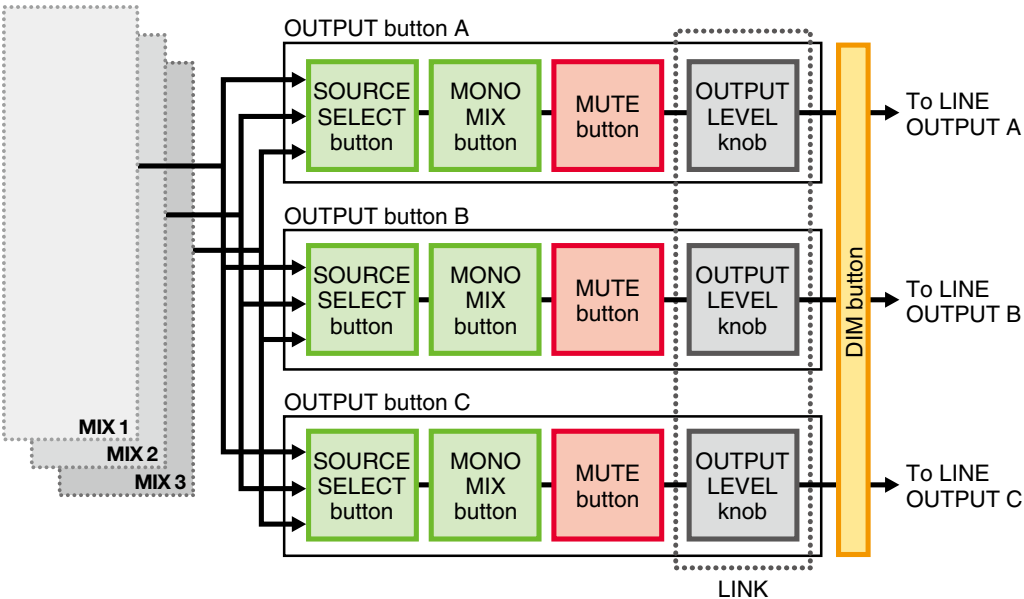

Block Diagrams

UR28M

4 Analog In/6 Analog Out, 2 Digital In/Out, 10 DAW In/6 DAW Out, 6+2 Bus

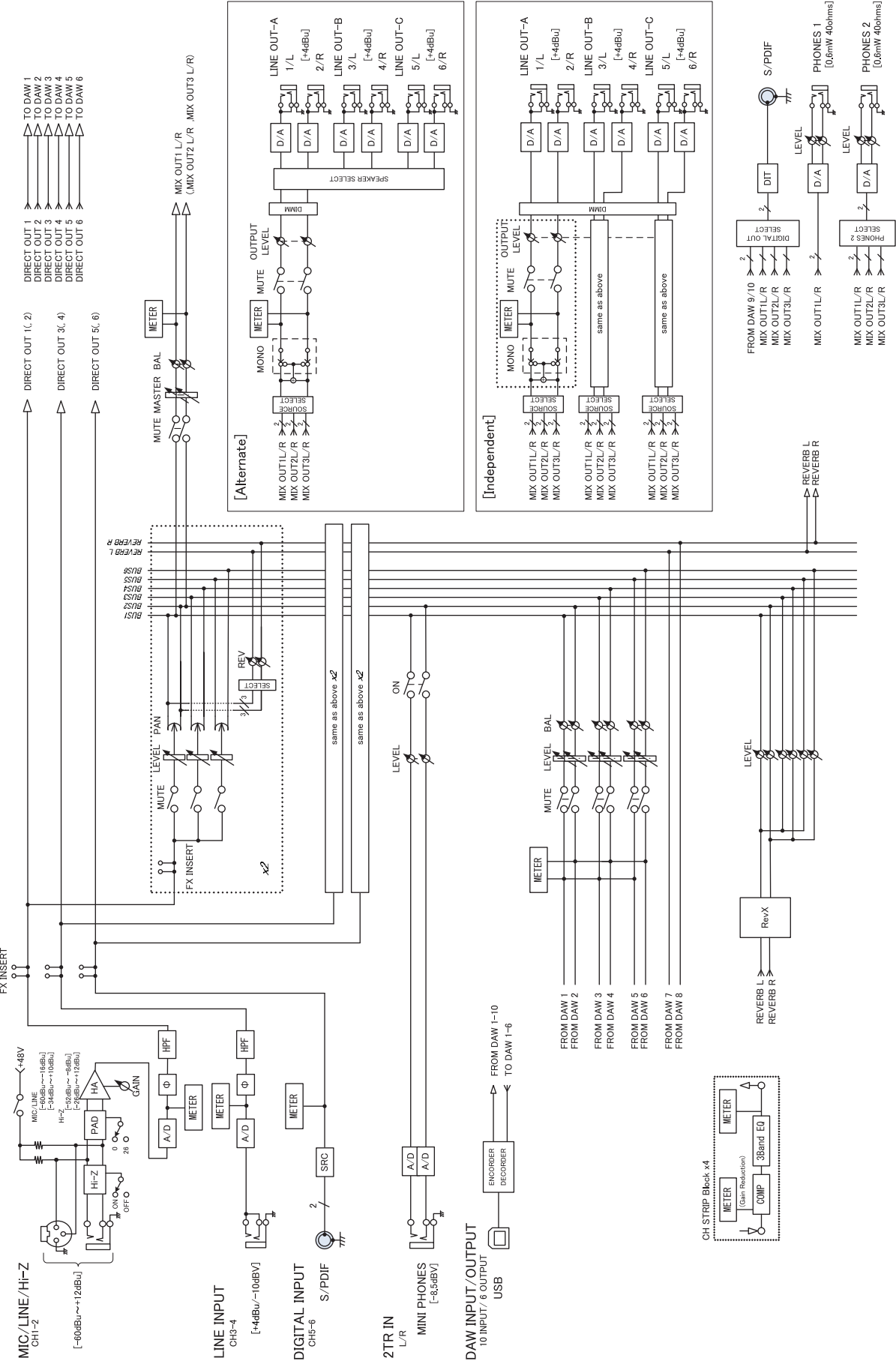

Steinberg Web Site
<http://www.steinberg.net>

C.S.G., Pro Audio Division
© 2011 Yamaha Corporation

111MW-C0

