

Civilization

What?

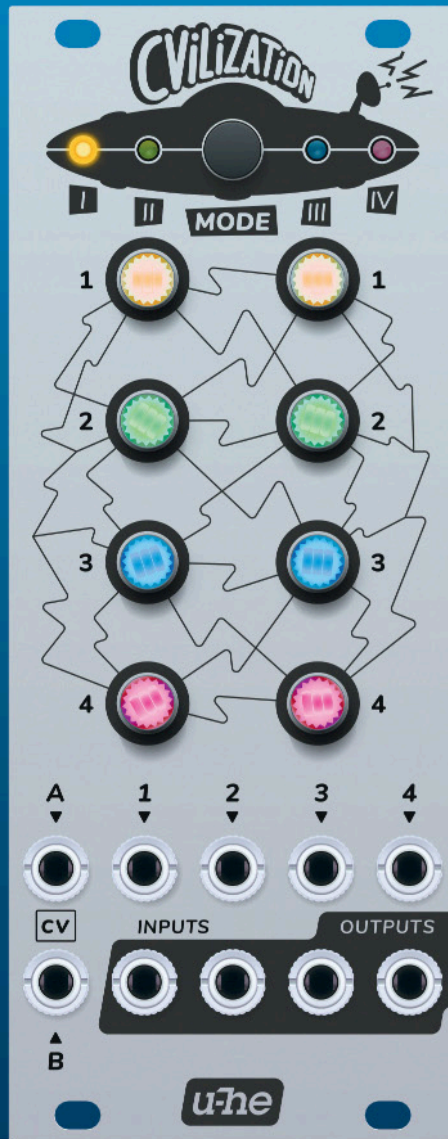

ultimate user guide



SPACE 
CERTIFIED
SUPERCOMPUTER

by **u-he**

Introduction	4
Installation	5
Four Modes	6
Terminology	7
Colour Coding	7
The Pages	8
Performance Page	8
Program Pages	8
Config Pages	8
Presets	8
Mode I: Matrix Mixer	9
Performance Page	10
Mute	10
Program Pages	10
Mix 1 Input to 4 Outputs	10
Mix 4 Inputs to 1 Output	10
Config Page 1	11
LE1 Quantization	11
LE2 Clock / Trigger Source	11
LE3 Clock Division	12
Config Page 2	12
LE1 Glide Time	12
LE2 CV-B Function	12
LE3 Tracking Time	13
Static Offsets	13
Mode II: Sequential Switch	14
Performance Page	15
Stop / Pause	15
Live Input Switching	15
Program Pages	15
Step Gain	15
Step Type	16
Config Page 1	16
LE1 Quantization	16
LE2 Clock / Trigger Source	17
LE3 Clock Division	17
Config Page 2	17
LE1 Glide Time	18
LE2 CV-B Function	18
LE3 Playback Direction	18

Mode III: Quad Mucorder	19
Performance Page	20
Sequence Length (optional)	20
Record / Playback / Erase	20
Mutation	21
Transposition	21
Config Page 1	22
LE1 Quantization	22
LE2 Clock / Trigger Source	22
LE3 Clock Division	23
Config Page 2	23
LE1 Glide Time	23
LE2 CV-B Function	24
LE3 Mutation Type	24
Mode IV: Quadraphonic Panner	25
Performance Page	26
Volume and Panorama	26
Program Pages	26
Auto-Pan & CV	26
Expert Features	27
User Scales	27
Basic Scales	27
Volt Map Scales	28
System Bus	29
Global Functions	29
LED Brightness	29
Jack Tester	29
Input Calibration	30
Clear Autosave Memory	30
Reset Quantization	30
Colour Palette Test	30
MicroSD	31
Firmware Updates	31
Options in CVZ.ini	32

CIVILIZATION IS A FRAGMENT OF UFO CONTROL PANEL RIGHT THERE IN YOUR EURORACK. ORIGINALLY DESIGNED TO PLOP IN AND OUT OF CHRONOSPACE FASTER THAN YOU CAN SAY "PLOP?", OUR TEAM OF SPECIALISTS AT U-HE LABS WERE NOT SURPRISED TO DISCOVER THAT THE ALIEN CIRCUITRY COULD ALSO PROCESS AUDIO AT THE SPEED OF SOUND! SO WE METICULOUSLY REVERSE-ENGINEERED THE ARTIFACT, INCLUDING ITS ABILITY TO MULTIPLY MATTER OR EVEN CREATE 4-DIMENSIONAL PANORAMIC VIEWS OF THE FUTURE...

Introduction

CVilization is a utility module designed for mixing, routing and sequencing up to four **CV or audio** signals. Three of the four modes include quantization, sample & hold and glide per channel.

CVilization sets a high technical standard for a digital Eurorack module: **+/- 10V** max. for the inputs and outputs, **24-bit / 96kHz**... and low latency thanks to a fast processor and modest buffer requirements.

CVilization is controlled by twisting and pressing **8 rotary encoders**. For visual feedback about the current function, the integrated **LEDs** change colour and brightness, sometimes 'breathing' or flashing.

A **performance page** with sub-pages (accessible by pressing encoders) replaces the usual encoder-plus-mini-display combination. After some practice, CVilization can be operated very quickly and effectively.

MODE button

Press repeatedly to step through the four modes

Also: To load a preset, hold MODE then **press** an encoder
To save a preset, hold MODE then **long-press** an encoder

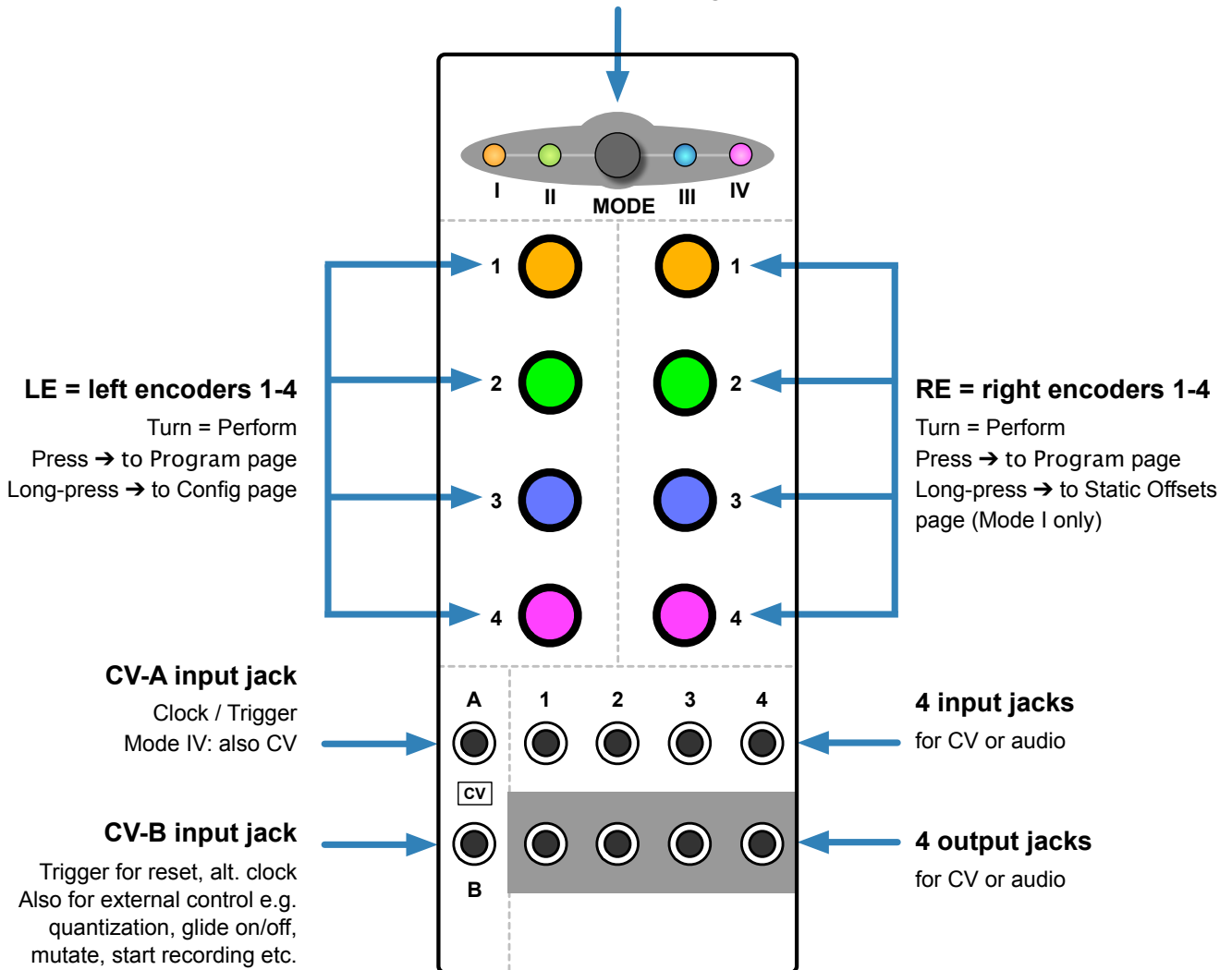

WATCH our **TUTORIAL VIDEOS** on **YOUTUBE**

Installation

Electrocution hazard!

Always turn the Eurorack case off and remove the power cord before connecting/disconnecting Eurorack bus board cables. Do not touch any terminals while attaching Eurorack bus board cables.

To operate correctly, CVilization requires maximum 95 mA at +12V, 24 mA at -12V and 130 mA at +5V (the +5V peaks may be higher in rare cases). The unit is protected against reverse power, so it should survive cables being attached the wrong way round. However, incorrectly installing the unit voids any warranty...

Find 10HP in your Eurorack case, confirm proper installation of the included Eurorack bus board connector cable on the rear of the module, plug the bus board connector cable into the Eurorack bus board, making sure that the red stripe on the cable is oriented to the NEGATIVE 12 Volt line on both the module and the bus board. Please refer to your case manufacturer's specifications for the location of the +5V and -12V supplies.

Disposal: Please refer to written information included with the hardware.

Limited Warranty

Heckmann Audio GmbH guarantees this product to be free of defects in materials and construction for a period of one year from the date of purchase (proof of purchase required).

Malfunction resulting from wrong power supply voltages, wrongly connected bus cables, mechanical abuse or other causes determined to be the fault of the user are not covered by this warranty, and normal service rates will apply. During the warranty period, defective units will be repaired (if possible) or replaced, with the customer paying the return postage.

Heckmann Audio GmbH accepts no responsibility for harm to person or apparatus caused through operation of this product. For more information, please contact support@u-he.com.

Technical Specifications

- Format: 10HP Eurorack module
- Power requirements: +12V (95 mA), -12V (24 mA), +5V (130 mA)
- Latency: 1ms

Inputs

- 2 CV: 12 Bit, 48kHz, +/- 10V
- 4 high-res: DC-coupled, 24-bit 96kHz, +/- 10V

Outputs

- 4 high-res: DC coupled, 24-bit 96kHz, +/- 10V

Modes

- 4 x 4 matrix mixer with optional matrix rotation
- 4 x 4 sequential switch with 8 sequences per output
- Quad 'Mucorder': CV step recorder – 4 tracks, 16-steps, realtime mutation
- Quadraphonic Panner: 4-channels, panning can be automatic and/or via CV

Presets

- Per mode: 7 user presets plus 1 for initialization purposes. Many more via [Select Bus](#).
- 8 global user-defined scales (voltage quantization)

Four Modes

Pressing the button in the **UFO** at the top steps through **modes I, II, III and IV...**

● **Mode I: 4 x 4 Matrix Mixer**

The Matrix Mixer can distribute the four input signals (audio or CV) to the four outputs. Pushing an encoder on one side then turning the four encoders on the other side gives you instant control of the mixture of all inputs into all outputs. Pushing the active ('breathing') encoder gets you back to the Performance Page, where you can mute each input and output.

● **Mode II: 4 x 4 Sequential Switch**

In this mode each output is an 8-step sequencer. Individual steps can be either one of the inputs (audio or CV), a skip or a static voltage. Gain can also be defined per step. You can use Mode II as a sequential switch or as e.g. four simple CV sequencers – or a CV sequencer plus 'other stuff' in parallel.

● **Mode III: Quad Mucorder**

A 4-channel, 16-step (quantizing) CV recorder. Recording can be activated manually or via external gate. During playback, sequences can be transposed via CV and **mutated**. While nothing is recorded, channels 'sample & hold'. With no input connected they act as random CV sources (as if the input was white noise).

● **Mode IV: Quadraphonic Panner**

Primarily for audio, this mode can also be used for modulation signals: Up to four input signals are smoothly panned across the four outputs, automatically as well as via CV. There are similarities with 'input scanning mixers', which dynamically blend multiple inputs into a single output, but the principle is reversed here.

Extra processors

Wherever it makes sense for the mode, **quantizers** with user-definable scales, **sample & hold** and **glide** can be individually applied to **each output**: CVilization is predestined for tonal algorithmic composition!

Power-on defaults

If you leave CVilization untouched for about **1 minute**, the current mode and its settings will be automatically saved. The saved settings will be loaded the next time CVilization boots up, so instead of saving the current state as a preset you can simply wait a minute before switching off.

THE ULTIMATE CIVILIZATION CHEAT SHEET!

UNLIKE THE 'QUICK START' GUIDES THAT OFTEN ACCOMPANY COMPLICATED DEVICES, CIVILIZATION'S ULTIMATE CHEAT SHEET IS AIMED AT THE MORE EXPERIENCED USER. RATHER THAN CLARIFYING USAGE IT IS DESIGNED TO CONFUSE THE NOVICE BY GIVING THE FALSE IMPRESSION THAT ALL FOUR MODES COULD BE EASILY EXPLAINED ON A SINGLE SHEET OF PAPER – YET, STRANGELY, NOT FOR THEM.

EXPERTS WILL CHUCKLE KNOWINGLY, AWARE THAT THE CHEAT SHEET CONTAINS SECRET INFORMATION THAT SOMETIMES PLOPS OUT OF THEIR MINDS WHILE TAKING A BREAK FROM THEIR MODULAR SYSTEM... WHAT?

ONLY NOOBS MISPLACE IT – EXPERTS KEEP IT CLOSE TO THEIR EURORACK AT ALL TIMES!

IN CASE OF LOSS, WE CARELESSLY LEFT A PDF VERSION SOMEWHERE ON OUR [WEBSITE](#) - LOOK AROUND, NOOBS!

Terminology

Please note the following terms and abbreviations, as they are used throughout this user guide!

LE means **left encoder** and **RE** means **right encoder**

For instance, '**RE1-4**' means any or all encoders on the right, while '**LE3**' means encoder 3 on the left.

Parameter

A particular function or choice of options.

Page

A set of CVilization parameters controlled by the 8 encoders, a **view** switchable via press / long-press...

Press

Instruction to push the top of an encoder and quickly release. Doing this usually opens a [Program Page](#).

Long-Press

Instruction to push the top of an encoder for **2+ seconds**. Doing this usually opens a [Config Page](#).

Channel

One of the four processors controlled by each pair of encoders. Called '**track**' in Mode III.

Breathe

An LED smoothly fading in and out ('breathing') identifies which Program Page is currently open. Pressing the 'breathing' encoder takes you back to the Performance Page. Note that Mode II plays a short sequence of different colours ('rainbow') instead, as all 8 encoders need to display values.

Blink

Similarly, a 'blinking' LED identifies which Config page is currently open. Blinking is also used for clock or trigger activity, for instance that a sequence is running.

Flash

While adjusting values, the LED(s) will flash once when either minimum or maximum is reached. LEDs will also flash when zero is reached, which is especially useful for centre-zero parameters.

Tick

While turning encoders you can feel them snapping to discrete values. We call each of these a 'tick'.

Colour Coding

Solid **ORANGE**, **GREEN**, **BLUE** or **MAGENTA** usually means the numbers **1**, **2**, **3** or **4** – for instance, the indices of the inputs and outputs. The MODE indicator LEDs also follow this general rule. An example applying to modes I, II or IV: If RE3 is green instead of blue, it often means that input **2** is routed to output **3**.

YELLOW and **PURPLE** stand for CV-A and CV-B, respectively.

TEAL (blue-green) is used for random or otherwise unspecified values.

Solid **RED** means 'mute', 'pause', 'skip' or 'recording', while **DARK RED** means 'unavailable'.

RUBY signifies negative values or inverted signals, and four PASTEL colours are used for Static Offsets.

The Pages

Performance Page

The default view for live performance, hence the name. The Performance page also serves as a **home base** from where you can navigate to all other pages...

Program Pages

Modes I, II and IV include pages for setting up a mix or programming sequences. Program pages are opened by simply **pressing** an encoder, which is then animated (usually 'breathing') to show you 1) where you are, and 2) which encoder you should press again to get back to the Performance Page.

Config Pages

Modes I, II and III have per-channel **configuration pages** where you can specify quantization type, a clock / trigger source, glide times, and how CVilization interprets a signal at the CV-B input.

Configuration pages are opened by **long-pressing** on LE1-4. Although basically the same for Modes I, II and III, the description appears in all 3 chapters for your convenience. A press on the **blinking** encoder will take you back to the Performance page.

Mode I also has four extra 'config-style' pages which let you set Static Offsets per output. These are opened by long-pressing on RE1-4.

Presets

Each Mode has 7 user presets (LE1-4, RE1-3) and 1 initialization preset ('**init**', RE4).

How to save a preset

Hold down the MODE button, wait a second, then **long-press** the encoder where you want to save your preset. Note that RE4 is reserved for the **init** preset which cannot be overwritten.

Preset data include mixer gains, sequences, glide, quantizer scales and the like. Presets do **not** include states such as the current step in a sequence, the current sample & hold value etc..

How to load a preset

Hold down the MODE button, wait a second, then **press** any illuminated encoder. If you haven't saved any presets yet, the only one available will be RE4 (init).

How to initialize a preset

To start from scratch, load the **init** preset: Hold down the MODE button, wait a second, **press RE4**.

More presets?

In addition to the 7 regular presets for each mode ($4 * 7 = 28$), CVilization can store up to 128 user presets in conjunction with **Select Bus** controllers such as the Malekko 'Varigate' series. For details of how to save and recall Select Bus presets, please refer to the documentation of the Select Bus controller.

See also Select Bus in the Expert Features chapter.

Mode I: Matrix Mixer

A traditional 'matrix mixer' routes multiple input signals to multiple outputs, with level controls determining how much of each input is sent to each output. In CVilization, 4 high resolution inputs can be freely mixed to 4 outputs. The **Performance Page** simply lets you mute individual inputs and outputs.

Both of the CV inputs **can** serve as clock inputs for Sample & Hold functions (see [Config Page 1](#) below) or for voltage controlled matrix manipulation. However, to avoid surprises while switching from another mode, neither CV input is active by default.

Basic operation

The encoders are arranged in pairs with the same colour LEDs: orange, green, blue, magenta...

- The left encoders (LE1-4) represent the inputs, the right encoders (RE1-4) represent the outputs
- Press **any encoder** to choose an input or output, then turn those on the **opposite side** to adjust levels
- When you are finished, press the currently 'breathing' encoder to go back to the [Performance](#) page

While in the Performance Page...

- To mute an input or output, turn the encoder one tick to the right (the LED appears red)
- To open the [Configuration](#) pages, **long-press** a left-hand encoder (LE1-4)
- To open the [Static Offsets](#) pages, **long-press** a right-hand encoder (RE1-4)
- Press the currently 'breathing' or 'blinking' encoder to go back to the [Performance](#) page

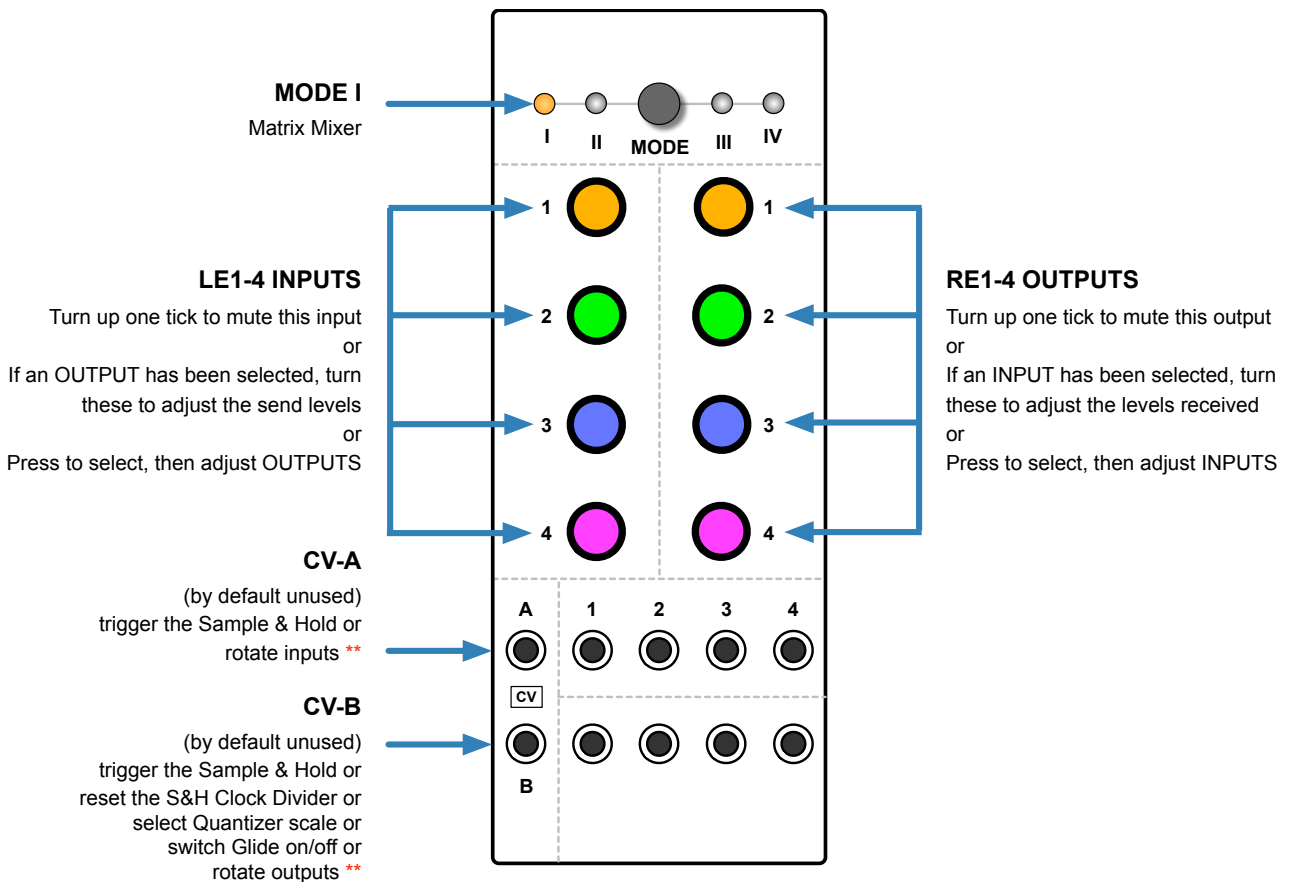

** [Matrix Rotation](#) is disabled by default. See [Expert Features](#).

Performance Page

Mute

Turning an encoder up one tick mutes that input or output, and the status LED turns red. Turning a muted encoder down unmutes it again, and the LED reverts to its channel colour.

Mute is the only function available in the Mode 1 Performance page.

Program Pages

The two methods described below control the very same parameters! Another thing to remember: You never have to go back to the performance page while mixing – to choose a different input or output simply press any encoder except the one that is currently breathing.

Mix 1 Input to 4 Outputs

Press one of the **left-hand** encoders. Its LED starts to breathe. Now turn each of the 4 encoders on the right: For positive values they adopt the colour of the input, with brightness indicating the levels. Negative values (inverted signal levels) appear ruby.

Press LE1-4 to select an input then turn RE1-4 to adjust the amount it sends to each output

- same colour as LE = normal signal level
- off zero signal level
- ruby inverted signal level

For example, if you press the orange LE (input 1), all encoders on the right will turn orange (or red or off, depending on their values). RE1-4 now adjust the amount of the input 1 signal mixed into each output.

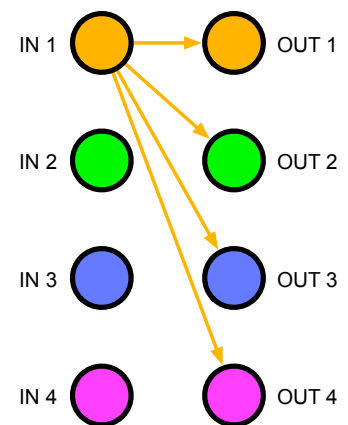

As your hand tends to obscure the encoder you are adjusting, **all 8 encoders** temporarily adopt the same colour and intensity. When either zero, minimum or maximum is reached, they flash once.

Mix 4 Inputs to 1 Output

Press one of the **right-hand** encoders. Its LED starts to breathe. Now turn each of the 4 encoders on the left: For positive values they adopt the colour of the input, with brightness indicating the levels. Negative values (inverted signal levels) appear ruby.

Press RE1-4 to select an output then turn LE1-4 to adjust the amount it receives from each input

- same colour as RE = normal signal level
- off zero signal level
- ruby inverted signal level

For example, if you press the orange RE (output 1), all encoders on the left will turn orange (or red or off, depending on their values). LE1-4 now adjust the amount of each input signal mixed into output 1.

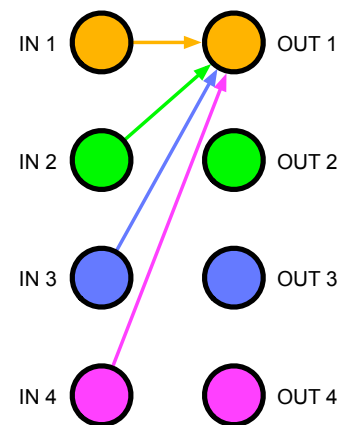

As your hand tends to obscure the encoder you are adjusting, **all 8 encoders** temporarily adopt the same colour and intensity. When either zero, minimum or maximum is reached, they flash once.

Config Page 1

From the Performance Page, **long-press LE1-3** for the following...

Quantization	<input checked="" type="radio"/>	<input type="radio"/>
Clock / Trigger Source	<input checked="" type="radio"/>	<input type="radio"/>
Clock Division	<input checked="" type="radio"/>	<input type="radio"/>
go to page 2	<input checked="" type="radio"/>	<input type="radio"/>

Press other LE to jump between parameters, or press the blinking encoder to exit.

LE1 Quantization

The quantizer forces voltages to musical scales at 1V/octave: It is meant for processing pitch CV, not audio. Note: Choosing quantization for all 4 channels on-the-fly is easy as they are all available on the same page.

Turn RE1-4

- off no quantization
- white Chromatic i.e. semitone steps

All other scales are user-definable i.e. you can replace these factory defaults (see [User Scales](#)):

- yellow Major
- green Natural Minor
- cyan Harmonic Minor
- light blue Pentatonic Minor
- blue Blues!
- magenta Phrygian dominant
- red Diminished
- ruby Alien Alloy = 111211122 semitone steps

LE2 Clock / Trigger Source

This page specifies the source which will be used for triggering the **Sample & Hold** (S&H) processor.

Turn RE1-4





- off no sample & hold for this output
- yellow CV-A triggers a new sample
- purple CV-B triggers a new sample
- orange CV-A OR CV-B (logical OR) triggers a new sample
- blue CV-A AND CV-B (logical AND) triggers a new sample
- teal Trigger via [System Bus](#) – see Expert Features

In Mode I, selecting any option except off here automatically activates Sample & Hold per output. If CV-B is used as trigger here, some options of the CV-B Function will be unavailable, and therefore appear **dark red** (see [LE2 CV-B Function](#) on the next page).

LE3 Clock Division

This page sets a division factor for a Clock (see [Clock / Trigger Source](#) above), effectively slowing it down.

Turn RE1-4

-  orange 1 x (default)
-  green 2 x
-  blue 4 x
-  magenta 8 x

Manual Clock Reset

Depending on when you switch Clock Division, things can easily get out of phase. To reset at the next trigger or clock, press **RE1-4** while LE2 or LE3 is selected. You can use this feature to shift clocks to the 'off-beat'.

LE4 Go to Config Page 2

Open the other configuration page.

Config Page 2

From the Performance Page, **long-press LE4** for the following parameters:

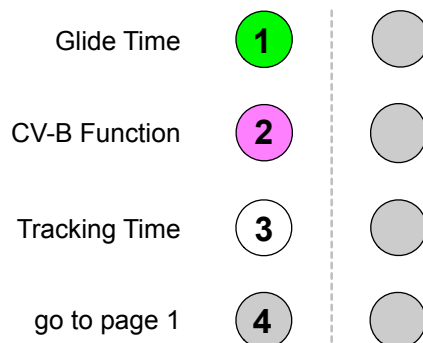

Glide Time is selected by default. To access **CV-B Function** or **Tracking Time** press LE2 / LE3.

LE1 Glide Time





Each channel has a 'slew limiter' a.k.a. **glide** processor which smoothes out any sharp transitions in the signal. Turn **RE1-4** to set the glide times for each output: The brighter the LED, the longer the glide.

Note: Applied to an audio signal, Glide acts like a simple lowpass filter!

LE2 CV-B Function

If CV-B is not already being used as [Clock / Trigger Source](#), you can use it for one of the following:

Turn RE1-4

-  off no function
-  salmon Reset the Clock Divider (see note below)
-  cyan Select quantization (via 0.5V steps). The colour for the selected scale flashes briefly whenever the voltage at CV-B changes sufficiently.
-  green Glide on/off (+3V, 0V).

If a function is unavailable, the RE will be **dark red**. Note1: 'Reset the Clock Divider' suppresses the other options on all channels. Note2: You **can** use CV-B as [Clock Source](#) for some channels and Reset for others!

LE3 Tracking Time

Although Tracking Times can only be adjusted in Mode I, they apply GLOBALLY

'Tracking Time' affects the **Sample & Hold** (S&H) processors, ensuring low latency while minimizing glitches. The name is a reference to the principle of 'Track & Hold'.

The tracking time can be set independently for the S&H of each output, and these apply globally to Modes I, II and III. As Mode IV does not use S&H, it is not affected.

Turn RE1-4

 Each **tick** while turning the encoder represents 1 millisecond (maximum is 10 ms).

Tracking Time addresses a common problem that plagues Sample & Hold timing in many modular systems. For example, if a sequencer and a S&H are receiving the same clock, the S&H can too easily 'freeze' a value before the sequencer has properly responded to the clock, before the target voltage has been reached.

Keyboards that trigger an envelope before the pitch CV has been fully established exhibit the same problem: The S&H will often send the 'previous' pitch instead of the current one. Or even something in between.

Delaying the clock for the S&H by a few milliseconds can help, but this is cumbersome and adversely affects overall timing – not the best strategy unless you enjoy spending more time finding the optimal settings.

CVilization can make its Sample & Hold quasi **permeable** for a few milliseconds after a trigger has occurred. With the right setting, pitches e.g. from a sequencer are only 'frozen' (i.e. sampled and held) after the target value is reached. This ensures optimal timing without any serious side effects...

Note: If there is visual feedback during tracking (e.g. recording in Mode III), the brightness of the LED can indicate a state somewhere before the end of the tracking time. This has no effect on playback or the audio.





LE4 Go to Config Page 1

Open the other configuration page.

Static Offsets

Applied to CV, you can use static offsets to retune oscillators or even shift notes via 'in scale' transposition, for instance. Adding a few Volts to an audio signal can be used to create characterful asymmetric distortion.

Long-press RE1-4

-  pastel orange Octaves (1 Volt) steps, max +/- 10 octaves
-  pastel green 'In-Scale Transpose' shifts notes within the scale selected in the [Quantization](#) page
Shifts semitones if quantization is switched off
-  pastel blue Semitones (0.083333 Volt) post-quantization, max. +/- 24 semitones
-  pastel magenta Cents (0.000833 Volt) post-quantization, max. +/- 100 cents

Select units by **pressing LE1-4**. Press the breathing encoder to return to the Performance Page.

Turn RE1-4 to set the amounts for each output (brighter = more, negative values appear ruby). The values from each unit will be added together, per output.

Mode II: Sequential Switch

Traditional 'Sequential Switches' route a single input to several outputs in succession, or several inputs to a single output. Most will give you some control over the playback order (forwards, backwards, random...).

Mode II is based on that same principle, but allows you to set up 4 independent 8-step sequences: One for each of the 4 outputs, all clocked via CV-A or CV-B, with optional Clock Division per sequence.

Basic Operation

In the Performance Page, each pair of encoders (orange, green, blue, magenta) represents a sequence.

- Turning LE1-4 down or up a tick selects **stop**, playback and **pause** for each sequence
- Turning RE1-4 increments / rotates the input for the current step (see Live Input Switching below)

The Program Pages use all 8 encoders, one for each step in the selected sequence:

- Pressing LE1-4 selects a sequence (1-4) and lets you adjust the **step gain** for the 8 steps
- Pressing RE1-4 selects a sequence (1-4) and lets you choose a **step type** for the 8 steps
- Press the flashing 'rainbow' encoder to go back to the Performance Page...

As the program pages in Mode II need to use **all 8 encoders** to display data, the selected encoder doesn't 'breathe' for orientation but flashes a **rainbow** every two seconds instead. Pressing that encoder will take you back to the Performance Page.

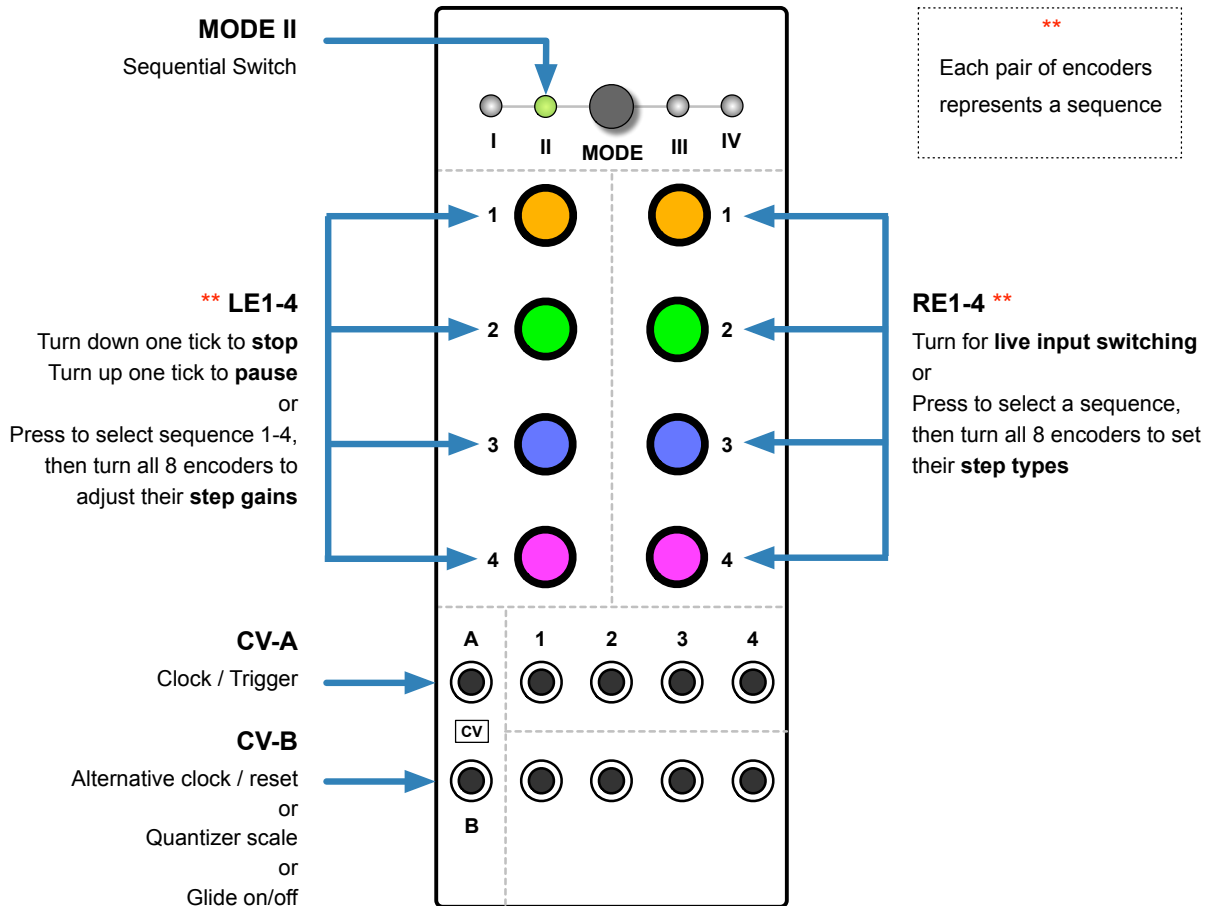



Performance Page

Stop / Pause

Turn the lefthand encoders **down** one tick to stop the sequence, or **up** one tick to pause:

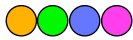
Turn LE1-4

	Playback
	off
	red
	Stop
	Pause

Stop

A sequence can be frozen at the current step by turning its **LE down one tick**: The LED switches off and the phase of the Clock Division (see below) is reset. When you turn the LE back up to Playback, the LED colour will revert to the respective sequence, and at the next trigger / clock it will **restart** from the first step.





Pause

A sequence can be **paused** at the current step by turning its **LE up one tick**. The LED goes red. The phase of the Clock Division is **not** reset. When you turn the LE back down again, playback will simply **continue** from where it was paused.

Live Input Switching

You can switch inputs on the fly by turning the right-hand encoders. Note that the 'special' step types *constant*, *random* and *skip* (see Step Type below) are not available here as that would be too confusing.

Turn RE1-4

	orange	Input 1
	green	Input 2
	blue	Input 3
	magenta	Input 4

Turning RE1-4 changes the input routing for the respective sequence **for the current step** – which may or may not be a moving target!

You can use **Live Input Switching** to 'step-program' all 4 channels without leaving the page: Turn RE1-4 to switch through the inputs for that channel at the current step, and increment the steps using a manual trigger source e.g. 'Pressure Points' or the Gate output of a keyboard connected to CV-A.

Program Pages

Step Gain

Press **LE1-4** to select a sequence: All 8 encoders go white (or shades of grey if they are turned down). Now turn the 8 encoders to set the **gain** (level / volume) for each step:

 darker = lower gain, brighter = higher gain.

You don't have to return to the Performance page to reach the Step Types – simply press RE1-4.

Step Type

Press **RE 1-4** to select a sequence. All 8 encoders will adopt the colour of the respective channel by default. Now turn the 8 encoders to select one of the following for each step:

Turn RE1-4

-  Input 1, 2, 3 or 4
- white +3V constant (can be set to max. +10V in CVZ.ini – see [Expert Features](#))
- red Skip the step
- teal Random value between 0 and +3V (or up to +10V – see [Expert Features](#))

Tip: You can set up a normal step sequencer (i.e. controlling pitches) by switching all step types to +3V then adjusting the voltages via LE1-4 ([Step Gain](#)). Use the [Quantizer](#) to straighten out the pitches.

You don't have to return to the Performance page to reach the Step Gains – simply press LE1-4.

Config Page 1

From the Performance Page, **long-press LE1-3** for the following...

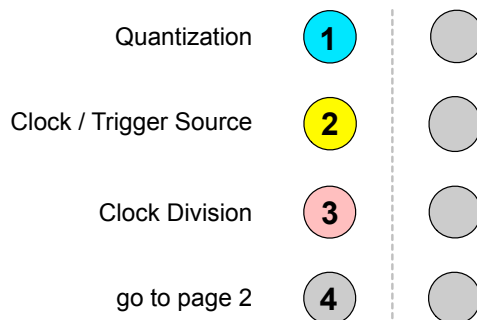

Press other LE to jump between parameters, or press the blinking encoder to exit.









LE1 Quantization

CVilization's quantizer forces voltages to certain musical scales at 1V/octave: It is meant for pitches, though especially the 'chromatic' option is quite useful for other purposes. Note: Setting quantization for all channels on-the-fly is easy, as they are all available on the same page. Press LE1 then turn RE1-4 to select a scale:

RE 1-4 (factory defaults):

- off no quantization
- white Chromatic i.e. semitone steps





All the other scales are user-definable i.e. you can replace these factory defaults (see [User Scales](#)):

-  yellow Major
-  green Natural Minor
-  cyan Harmonic Minor
-  light blue Pentatonic Minor
-  blue Blues
-  magenta Phrygian dominant
-  red Diminished
-  ruby Alien Alloy (111211122 semitone steps)

LE2 Clock / Trigger Source

Press LE2 then turn RE1-4 to select the Clock / S&H input(s) for each channel:

RE1-4

-  yellow CV-A triggers a new switch / sample
-  purple CV-B triggers a new switch / sample
-  orange CV-A or CV-B (logical OR) triggers a new switch / sample
-  blue CV-A and CV-B (logical AND) triggers a new switch / sample
-  teal Trigger via System Bus – see Expert Features



Sample & Hold on/off

To toggle Sample & Hold per channel, press **RE1-4** while LE2 is selected.

LE3 Clock Division

Press LE3 and turn RE1-4 to set a division factor for the clock (but not for S&H – see the note below):

RE1-4

-  orange 1 x
-  green 2 x
-  blue 4 x
-  magenta 8 x

Note that in Mode II the Clock Division setting doesn't affect the Sample & Hold: The S&H will react to ALL triggers / gates at the specified input (see LE2: Clock / Trigger Source above).

Manual Clock Reset









Depending on the selected Clock / Trigger Source, and at what point in time you switch the Clock Division, things can easily get out of phase. To fix this problem, press RE1-4 while LE3 is selected: The phase will be reset at the next clock / trigger.

LE4 Go to Config Page 2

Open the other configuration page.

Config Page 2

While on the Performance Page, **long-press** LE4 for the following parameters:

- | | | |
|---------------------|---|---|
| Glide Time |  |  |
| CV-B Function |  |  |
| Playback Direction |  |  |
| go to Config page 1 |  |  |





LE1 Glide Time

If it isn't already blinking, press LE1. Then turn **RE1-4** to set the glide times for each channel: The brighter the LED, the longer the Glide. When applied to audio signals, Glide acts like a simple lowpass filter.

LE2 CV-B Function

If CV-B is not already being used for the Clock / Sample & Hold, you can control the following instead:

Turn RE1-4





-  off no function
-  salmon On the next trigger, reset the sequence to the first step
-  cyan Quantization selection (via 0.5V steps). The colour for the selected scale flashes whenever the voltage at CV-B changes sufficiently.
-  green Glide on/off: +3V switches Glide on, 0V switches it off again.

If a function is not available, the RE will turn **red**.

LE3 Playback Direction

Specify the order in which steps are played back.

Turn RE1-4

-  green Forwards
-  red Backwards
-  magenta Zig-zag (L1–R1, L2–R2, L3–R3, L4–R4)
-  teal Random

LE4 Go to Config Page 1

Open the other configuration page.

Tracking Time

Although this option also applies to Mode II, it can only be set in Mode I. [Read about it there...](#)

THE WORLD'S LEAST INTUITIVE EURORACK MODULE?

WE DON'T KNOW WHETHER CIVILIZATION IS INDEED THE WORLD'S LEAST INTUITIVE EURORACK MODULE, BUT GIVEN U-HE'S REPUTATION FOR DESIGNING MIND-BOGGLINGLY COMPLEX AUDIO SOFTWARE PLUG-INS – SUCH AS A DIGITAL DELAY WITH 247 PARAMETERS – IT SEEMED AN UNCANNY FIT FOR THEM TO ENTER THE REALM OF EURORACK MODULARS WITH A DEVICE THAT GIVES FEW VISUAL CLUES AS TO WHAT IS ACTUALLY HAPPENING, YET IS JAM-PACKED WITH FUNCTIONALITY!

WHEN ASKED ABOUT THIS, URS HECKMANN, U-HE FOUNDER WITH A DEGREE IN INDUSTRIAL DESIGN, ALLEGEDLY FLASHED A MOST DEMONIC GRIN AND UTTERED THE FOLLOWING WORDS: "IT TOOK TWENTY-TWO YEARS FROM MY GRADUATION UNTIL I COMPLETED MY FIRST HARDWARE PRODUCT. I FELT I HAD TO MAKE A STATEMENT THAT OVERTURNS ALL THE STANDARDS OF MY PROFESSION!" OTHER SOURCES SUGGEST THAT THIS IS JUST AN EXCUSE FOR HAVING REMEMBERED THE 'FORM FOLLOWS FUNCTION' PRINCIPLE MUCH TOO LATE.

Mode III: Quad Mucorder

Mode III transforms CVilization into a 4-track, 16-step 'Mutagenic CV Recorder'. You can record more than one track ('sequence') at a time, and recording can be initiated manually or via external gate. If transposition is activated, individual sequences can be shifted up or down via CV (1V/octave) at the 4 inputs.

Unlike other modes, the Quad Mucorder was designed specifically for processing CV. As the Sample & Hold is permanently active, Mode III is not suitable for processing audio.

Playback can be **mutated** per track. With the default mutation type, the intervals either widen or approach the first recorded value. The mutation rate is adjustable from very slow to 'a bit too fast'.

CV A serves as the necessary **clock input** for recording as well as playback. CV-B can be used for various duties, including extra clock, remote record / stop or even mutation control.

Basic Operation

- **Optional:** Turn LE1-4 to specify the sequence length i.e. number of steps that will be recorded.
- Press LE1-4 to start recording. If the input jack is unused, random values will be recorded
- Press LE1-4 again to stop recording 'early' e.g. if you only want to record 7 steps
- After recording, turn LE1-4 one tick up to activate **transposition** via CV at inputs 1-4
- Turn RE1-4 to **mutate**. Default: Negative values narrow the range, positive values widen the range
- Press RE1-4 to **freeze**, press again to set **zero** mutation, or long-press to **overwrite** the recording
- If you like, save all 4 tracks as a preset. Or erase a track by pressing LE and RE at the same time.

**
Each pair of encoders represents a track

** LE 1-4
Turn to specify no. of steps
Press to start/stop recording
Turn 1 tick up to activate transposition via CV at input

CV-A
Clock / trigger (required)

CV-B
Reset to first step or quantizer selection or glide on/off or record/stop or dub or mutation control

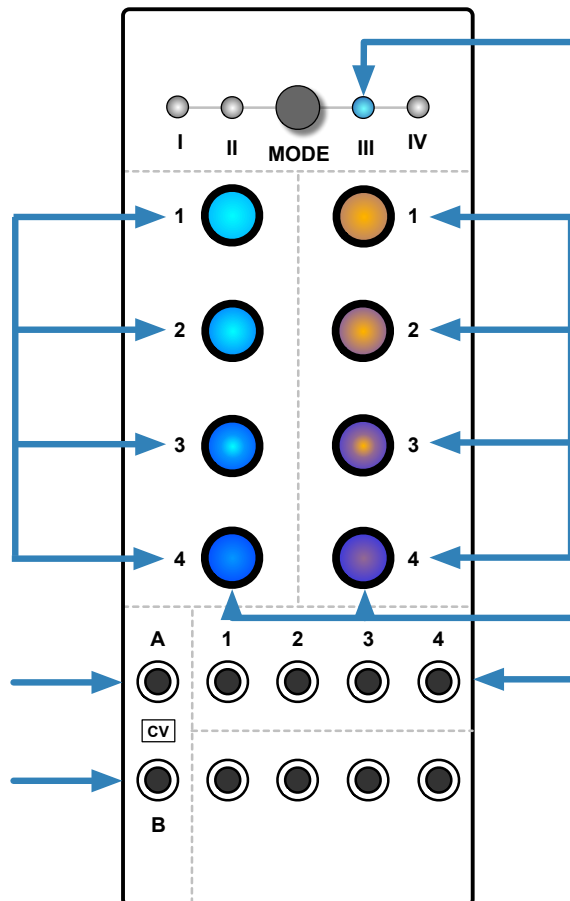

MODE III
Quad Mucorder

RE 1-4 **
Turn up to mutate a track or turn down to unmutate
Press to freeze the mutation
Press again to zero mutation
Long-press to save mutation

LE1-4 + RE1-4 **
Press both to erase a recording

Input CV
Inputs 2, 3 and 4 are normalised to input 1 so you can record all 4 sequences from a single source

Random / Input Normalling

For all unused inputs, a random value is generated per step, just like the classic 'Random Sample & Hold'. The inputs themselves are **normalled** from left to right. For example, as soon as a cable is plugged into input 2 (only), this signal also appears at inputs 3 and 4, while the random signal still appears at input 1.

Keyboard Experiments

If you own a CV-capable keyboard we recommend connecting its **Gate** output to CV-A and its **Pitch CV** output to Input 1. Tip: You can record all 4 tracks without having to plug anything into inputs 2, 3 or 4.

Patch the 4 outputs into oscillator pitch CV inputs etc.. If you now press LE1, the separate notes you play on the keyboard will be recorded like in a classic step sequencer. Tip: You can play *legato* until you have found the note you want to record, then lift your hand – it is the **closing gate** that actually triggers the sample!

If you ever hear the previous note instead of the current one while playing the keyboard you should temporarily select Mode I and increase the Tracking Time for that channel. A few milliseconds is usually enough, but you might have to go back and forth between Mode III and Mode I a few times to get it right.

After recording, try connecting a regular clock to CV-A instead of the gate from the keyboard (but keep the pitch CV attached), then turn LE1 one tick up to activate Transposition. Experiment!

Performance Page

Sequence Length (optional)

By turning LE1-4 you can specify the **maximum number of steps** that will be recorded. Here's the default colour scheme for those numbers (see Sequence Length Colour Scheme for alternatives):

Turn LE1-4 before recording

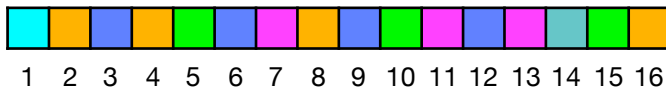

There is logic behind the exotic order of colours:

- cyan 1 only
- orange powers of 2
- blue multiples of 3
- green multiples of 5
- magenta upper prime numbers
- teal the odd one out!

Distinguishing and remembering 16 different colours would have been impractical, but remembering 5 or 6 is acceptable. Another advantage is that most same-colour numbers are rhythmically related. If you would prefer to allow transposition before recording instead of this feature, you can change 'Set Sequence Length' to 'no' in CVZ.ini (see Options in CVZ.ini).

Record / Playback / Erase

Press LE1-4

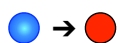

Pressing one or more LE starts recording those tracks – the LEDs turn **RED**. A new value is sampled from the inputs at each clock, up to 16 steps. You can stop the recording early by pressing the same LE again.

Note: Sample & Hold is disabled during regular record, but not during record/dub via CV-B. See Tip 2 below.

The channel switches to **Playback** mode as soon as recording is finished.

To **erase** a recording, briefly press LE and RE of the track at the same time. The track will return to its original state (S&H) at the next clock, and you can choose a new sequence length or record up to 16 steps. The most recent value is retained until the next clock arrives to avoid jumps during live performance.

Mutation

While a sequence is playing back you can **mutate** it by turning the corresponding RE up or down. For the sake of simplicity, the following describes how the **default Mutation Type** reacts.

Turn RE1-4



Turning RE1-4 up (blue) during playback causes the intervals to widen, and the effect builds up each time the sequence repeats. The more you turn it up, the faster the sequence will mutate.

Turning RE1-4 down (ruby) effectively does the opposite: the sequence mutates towards the first recorded value. The intervals decrease until the entire sequence consists of a single pitch...

IMPORTANT: Although you can call this 'unmutation', it does **not** undo the steps of a previous mutation!

Note: Each track has a somewhat different mutation 'personality' by default – see the Mutation Settings!

Freeze Mutation

Sometimes you will want to keep the result of a mutation going for a while. Instead of quickly turning the RE back to zero, you can simply press it: The mutation value will jump to zero.

Undo Mutation

By pressing the RE again (or at any time when the mutation is at zero) the original recording is restored.

Save Mutation

A **long-press** on the RE replaces the original recording with the current state.

Transposition

During playback, the main inputs can be used to transpose sequences (pre-quantization).

Turn RE1-4 up one tick

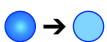

If the input is unused and not normalled to another input (see **Random / Input Normalling** above), the recording will be transposed by a random value at each trigger / gate.

As with mutation, the reference for transposition is the first recorded value in the sequence. For example if your sequence starts with a D3, playing a D3 will not transpose the sequence, while an A3 would transpose it up a fifth i.e. 7 semitones. Note that transposition is automatically deactivated during recording.

Tip 1: Recording Chords.

You can also use *Pressure Points* or similar to record harmonies on several tracks at the same time. Here's how: Patch the 3 main PP outputs with 3 of the CVilization inputs, and a gate output to CVilization's CV1 input. The PP knobs define the chords, and tapping on the active PP channel will send a gate that will cause CVilization to record the chord.

Tip 2: Pre-S&H

During regular recording (i.e. not via CV-B), signals are not processed 'live' with Sample & Hold, for various reasons. If you really need it you can patch your signal via an unused CVilization channel, which can do the Sample & Hold processing "up front".

Config Page 1

From the Performance Page, **long-press LE1-3** for the following...

Quantization	1	<input type="radio"/>
Clock / Trigger Source	2	<input type="radio"/>
Clock Division	3	<input type="radio"/>
go to page 2	4	<input type="radio"/>

Press other LE to jump between parameters, or press the blinking encoder to exit.

LE1 Quantization

CVilization's quantizer forces voltages to certain musical scales at 1V/octave: It is meant for pitches, though especially the 'chromatic' option is quite useful for other purposes. Note: Setting quantization for all channels on-the-fly is easy, as they are all available on the same page. Press LE1 then turn RE1-4 to select a scale:

Turn RE1-4

- off no quantization
- white Chromatic i.e. semitone steps

All the other scales are user-definable i.e. you can replace these factory defaults (see [User Scales](#)):

- yellow Major
- green Natural Minor
- cyan Harmonic Minor
- light blue Pentatonic Minor
- blue Blues!
- magenta Phrygian dominant
- red Diminished
- ruby Alien Alloy = 111211122 semitone steps

LE2 Clock / Trigger Source

Press LE2 then turn RE1-4 to select the clock / trigger input(s) for each channel:

Turn RE1-4

- yellow CV-A triggers a new sample
- purple CV-B triggers a new sample
- orange CV-A OR CV-B (logical OR) triggers a new sample
- blue CV-A AND CV-B (logical AND) triggers a new sample
- teal Trigger via [Bus Gate](#) – see Expert Features



LE3 Clock Division

Press LE3 then turn RE1-4 to set a division factor for the clock, per channel.

The Clock Division factor not only affects playback, but also the 'rate' at which sequences are recorded. If set to 8, for example, then the input will only be sampled every 8 triggers: See the info box below.

Note: Recording while Clock Division is not set to 1x can be tricky, so you should "expect the unexpected"!

Turn RE1-4

-  orange 1 x
-  green 2 x
-  blue 4 x
-  magenta 8 x

Step Recording

The Clock Division factor also applies during step recording – CVilization cannot know whether you are recording manually or are in the middle of a live performance. Tip: Instead of repeating each note enough times to actually be recorded, **temporarily set the Clock Division to 1**.

Manual Clock Reset









Depending on the selected Clock / Trigger Source, and at what point in time you switch the Clock Division, things can easily get out of phase. To fix this problem, press **RE1-4** while either LE2 or LE3 is selected: The phase will be reset at the next clock / trigger. Tip: You can use this feature to shift clocks to the 'off-beat'!

LE4 Go to Config Page 2

Open the other configuration page.

Config Page 2

From the Performance Page, **long-press** LE4 for the following functions:

- | | | |
|---------------|---|---|
| Glide Time |  |  |
| CV-B Function |  |  |
| Mutation Type |  |  |
| go to page 1 |  |  |









LE1 Glide Time

If it isn't already blinking, press LE1. Then turn **RE1-4** to set the glide times for each channel: The brighter the LED, the longer the Glide. Note: When applied to audio signals, Glide acts like a simple lowpass filter.

LE2 CV-B Function

If CV-B is not already being used as the Clock / Trigger Source, you can control the following instead:

Turn RE1-4

-  off no function
-  salmon Reset to the first step
-  cyan Quantization selection (0.5V steps). The colour for the selected scale flashes whenever the voltage at CV-B changes sufficiently
-  lime green Glide on/off (+3V, 0V)
-  orange Record start/stop (+3V trigger toggles the status) **
-  green Dub recording i.e. 'drop in' while a gate at CV-B is high (+3V) **
-  blue Mutate via CV (bipolar +/- 5V)
-  magenta Undo mutation (+3V trigger)

If a function is not available, the RE will turn **dark red**.





When recording / dubbing is activated via gate / trigger at CV-B, the Sample & Hold as well as the reference value for transposition / mutation from the original recording remain active i.e they are not overwritten.

If the RE remains in the central position while controlling mutation via CV, mutation freeze will not be available (pressing the RE will reset the sequence instead). To freeze the mutation, unplug the CV-B cable.

** Active recording via CV-B is indicated by a **purple** RE, and active dub recording by **green**.

LE3 Mutation Type

Here you can choose the kind of mutation applied in the Performance page.

-  orange Narrower / wider intervals (default)
-  green Randomly (i.e. at irregular intervals) copy the CV signal from the corresponding input.
-  blue Randomly copy from the track "above". Specifically: Track 4 copies from track 3, track 3 copies from track 2, track 2 copies from track 1, and track 1 copies from track 4.
-  magenta Harmonize = create harmonic structures **for all channels**, with channel 1 (as master) setting the fundamental, and channels 2-4 tending towards the 3rd, 5th and 7th.

LE4 Go to Config Page 1

Open the other configuration page.

Tracking Time

Although this option also applies to Mode III, it can only be set in Mode I. [Read all about it there...](#)

ORIGIN OF THE NAME: MUCORDER

CONTRARY TO POPULAR BELIEF, THE WORD "MUCORDER" WASN'T COINED AS A PORTMANTEAU OF "MUTATE" AND "RECORDER". THE ORIGINAL NAME "MOOCORDER" WAS A REFERENCE TO THE ALIEN HABIT OF HERDING CATTLE VIA TRACTOR BEAM IN ORDER TO LEARN THEIR LANGUAGE. A HIGHLY DEMANDING PROJECT, AS BOVINE CONVERSATION CONSISTS ENTIRELY OF VARIATIONS ON THE WORD "MOO". PERHAPS THEY ALSO LIKE STEAK?

ONLY AFTER OUR ENGINEERS DETERMINED THAT THE SAME ARTIFICIAL INTELLIGENCE WHICH WAS RESPONSIBLE FOR COW STUDIES COULD ALSO BE USED TO RECORD AND MUTATE STEPPED CV SIGNALS, WAS THE NAME OF THE ALGORITHM CHANGED TO "MUCORDER". SNAPPY, EH?

Mode IV: Quadraphonic Panner

The **Quadraphonic Panner** may be the simplest mode in CVilization, but it is no less interesting...

This mode was originally conceived as a smooth counterpart to Mode II, but since each output of the Sequential Switch can already switch inputs, we decided to reverse the principle here and pan each input across the 4 outputs, automatically and/or via CV. As CVilization can also process audio signals, Mode IV can be used as a traditional quadraphonic audio mixer.

For Mode IV we decided to abandon the classic CV processors (sample & hold etc.) in favor of effects that are more focused on audio. That's the reason why Mode IV has no configuration pages!

One highlight of this mode is **automatic panning**: As well as a volume for each input, you can also set a nominal pan position which can then be shifted, either automatically or via CV-A and CV-B.

Finally, **Auto Hop** jumps to a random pan position on each transient ('blip' in the audio), which makes this option especially interesting for percussive material.

Basic operation

- Turn LE1-4 to adjust **input volumes**, indicated by the brightness of the encoders as you turn.
- Turn RE1-4 to adjust the **pan positions** for each input. If you prefer to focus on just one input, press that RE first. After you are finished, press it again.
- Both CV inputs are used for external pan control.

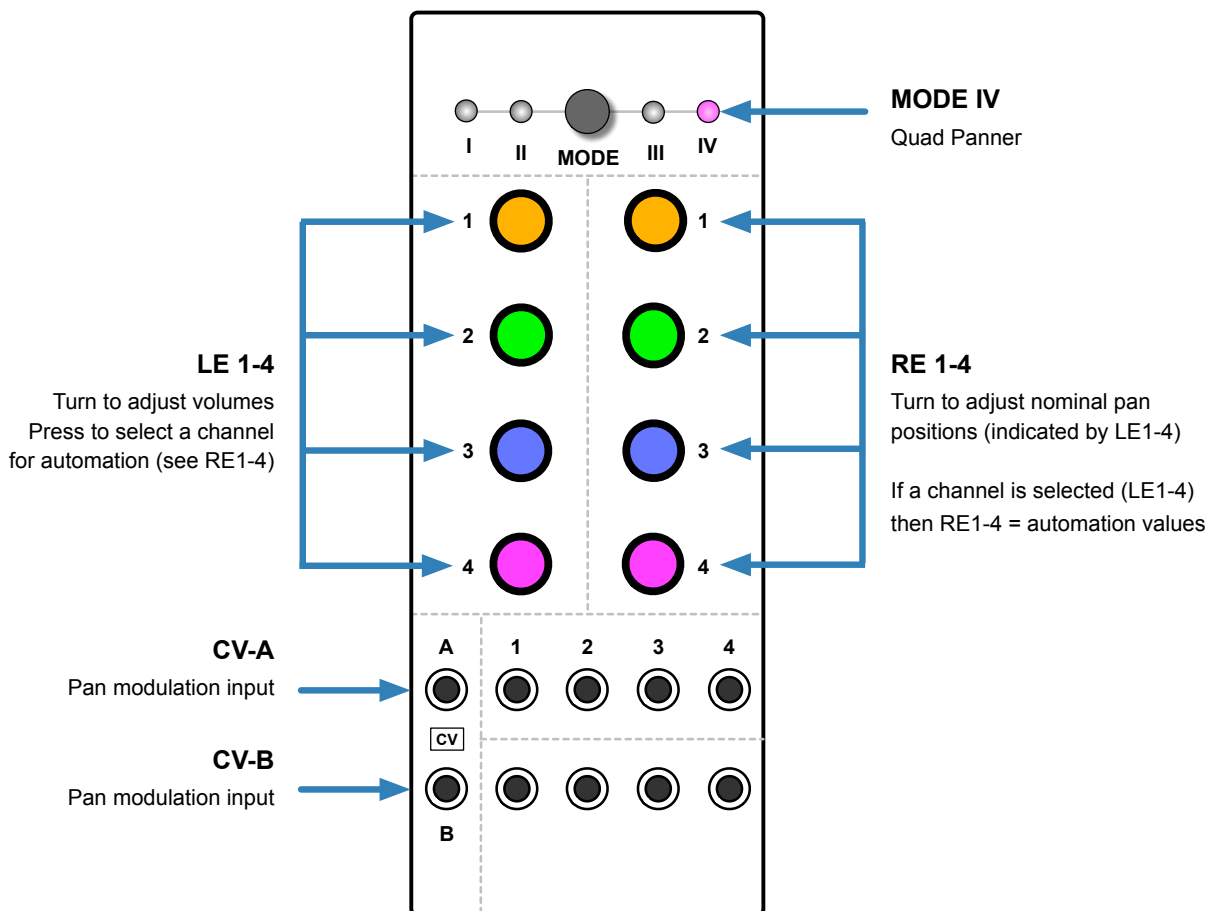

Performance Page

Volume and Panorama

On the Performance page you can adjust the volumes (LE) and nominal pan positions (RE):

Turn LE1-4



Input volumes of each channel, indicated by the brightness of all 8 encoders

Turn RE1-4

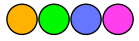

Nominal pan positions per input, indicated by the LE from pure orange (output 1 only) to pure magenta (output 4 only) and beyond. Intermediate positions mix the colours and relative brightness of adjacent LEDs.





Channel Focus

If you press a RE you will only get visual feedback for that one channel (the corresponding LE will light up). Press the RE again to return to the full Performance page.

Program Pages

Auto-Pan & CV

Pressing a LE enters the Program Page for that particular channel's pan automation. RE1-4 introduce panning as follows (note that they can all be used at the same time):

-  RE1: Auto-Pan speed (red = backwards)
-  RE2: One tick up switches Auto-Hop (see below) on; brighter = slower / smoother hops
-  RE3: Amount of pan modulation from CV-A (negative values are ruby)
-  RE4: Amount of pan modulation from CV-B (negative values are ruby)

As always, pressing the breathing encoder will take you back to the Performance page.

Auto-Hop

Whenever CVilization recognizes a transient in the input signal, it can **pan the signal to a random position**. The Auto-Hop effect can be very dramatic when used with a 'surround' system (e.g. quadraphonic or 5.1), especially when applied to percussive sounds and with minimum smoothing (RE2 just one tick up).









Expert Features

CVilization is customizable in various ways: From the choice of colour-schemes to the clock reset paradigms to alternative control options and voltage ranges. However, we strongly recommend that users new to CVilization familiarize themselves with the unit before attempting to explore its more 'esoteric' side!

User Scales

CVilization lets you record two different kinds of user-scales: 'Basic Scales' and 'Volt Map Scales'. While the former divides 1 Volt input into 12 steps and maps each to a note within an octave, the latter maps a sequence of notes (voltages) onto 1 Volt, in the order they were played.

Here's that list of factory scales again. You can replace any or all of them:

	yellow	Major
	green	Natural Minor
	cyan	Harmonic Minor
	light blue	Pentatonic Minor
	blue	Blues
	magenta	Phrygian dominant
	red	Diminished
	ruby	Alien Alloy (111211122 semitone steps)

Basic Scales

These are your regular 'can't play a wrong note' scales, optimized for playing via keyboards or other quantized, 1 Volt per octave CV sources. Each Volt is divided into 12 steps, and any steps that don't conform to the desired scale are shifted accordingly.

Recording basic scales using a keyboard

For this you will need **pitch CV** and **gate** signals, either directly from a CV capable keyboard or from a MIDI keyboard via MIDI to CV converter. Then...

- Select any CVilization **Mode** and initialize a preset.
- Connect the keyboard's **pitch CV** output into a CVilization input and its **gate** output to CV-A.
- Connect the corresponding CVilization output to an oscillator's pitch CV input (1V/oct)
- Complete the patch such that you can hear melodies on the keyboard when you play.
- Open the Quantizer page, choose a scale you would like to replace. then **long-press** that same RE. All encoders turn a bluish colour to indicate that CVilization is ready for Basic Scale recording.
- Play the notes you want to be included in the scale. Neither the octave nor the order of notes matter here. The encoders will light up whenever a unique note is added.
- Press any encoder to exit and test the new scale. If you enter all 12 possible notes, recording will end.

Volt Map Scales

Although they will be used as such, these are not really scales in the classical sense, but note sequences meant to be driven from an arbitrary CV source.

Up to 32 notes are evenly assigned across 1 Volt, in the order they are recorded. The first recorded note is always mapped to a C: For instance, if the first note you record is an F#, when you use this scale afterwards you will need to play a certain C on your keyboard to get that F#. However...

Repetition Interval

Volt Map scales allow for repetition intervals other than an octave. The interval between the first and last notes you record will apply **for each Volt above the 0V octave** ('zero Volt octave'). This means that different octaves are likely to give you a different set of notes. Remember: The very last recorded note will not be included in the scale, but defines the repetition interval instead.

Here's an example: You record D, E, F, then a C in next octave. This last note sets the repetition interval to 10 semitones, the interval between the first and last steps (D and C).

Volt Map Scales don't compensate for origin: If you play a C in the 0V octave you will hear your first scale step – the D. If you now play a C one octave above that, you will get a C, as the repetition was set to only 10 semitones instead of the usual 12. Playing the C an octave above that will give you an A#, and so on...

How to record a Volt Map

The procedure is similar to Basic Scale recording except that you **long-press the encoder one more time**. The outer two mode LEDs (I and IV) will light up, indicating that CVilization is ready to record a Volt Map.

Remember that the last recorded note is not part of the scale, but sets the repetition interval. To keep things simple for now, your last note should be an octave i.e. 12 semitones above the first. Again, you can record up to 32 notes steps plus the repetition interval. Complete the recording by pressing any encoder.

A few Ideas

Volt Map scales are not meant to be driven from a standard keyboard, but from an arbitrary CV source...

- With a random CV source, repeated notes in the 'pool' increases their probability.
- With a sawtooth LFO the scale effectively turns into a sequence.

Tip: If you want to play Volt Maps via keyboard

...or similar quantized modulation source, you should record **12 steps** plus the note for the repetition interval. Doing this will ensure that no steps will fall 'in between the keys' and therefore become unreachable from the keyboard.

- With a keyboard you can only reach 12 notes per octave, but it can have any 'layout': For instance you could map octaves upside down, or create a scale that stays within the same two octaves.
- With different Volt Maps on different channels you can program one-finger chords or sequencer-controlled chord progressions.

System Bus

Bus Gate

The **TEAL** option in Clock/Trigger Source I lets you use the 'Bus Gate' line of the Eurorack system bus for various triggers / gates (instead of CV-A or CV-B). Alternatively, MIDI Clock through Select Bus can be used instead, if this is enabled in the CVZ.ini file on the SD Card (see below).

Select Bus

Select Bus is a MIDI-based protocol which repurposes the Eurorack internal system bus. CVilization makes use of the preset switching capabilities as well as Start/Stop messages.

CVilization only acts as a Select Bus **receiver**: To use Select Bus you will need a suitable **sender** such as *Malekko Varigate 8+*, *WMD Metron* or *ES Select Bus Breakout* connected to the same Eurorack bus rails.

Presets

Independent of the 28 (4 x 7) regular presets, CVilization also provides 128 Select Bus preset slots. While loading Select Bus presets, CVilization automatically switches to the Mode that was stored with the preset.

Notes: 1) Program Change messages for empty presets are ignored. 2) Most Select Bus modules can only address up to 64 presets. For details, please refer to the appropriate manual. 3) Due to hardware limitations, CVilization also ignores the "Save All" message supported by certain Select Bus modules.

Important: You cannot store or load regular presets via Select Bus – the two types are entirely separate!

MIDI Start/Stop

By default, whenever CVilization receives a MIDI 'Stop' message, it resets all clock divisions and sequences. MIDI 'Start' can also be used for the reset – see the two MIDI Reset options in CVZ.ini below.

Global Functions

A few settings common to all 4 modes are directly available without you having to edit CVZ.ini (see below). To enter the main page, **hold the MODE button while powering up** for about three seconds. The MODE LEDs I, II and IV will light up.

LED Brightness

● LE1

This setting affects all encoders and mode LEDs. Turn LE1 to adjust the value, then long-press to save: All encoders blink green to confirm. Note: Increasing the brightness also increases the current consumption on the +5V rail, and this can even reach 238mA (flashlight)! Setting maximum brightness is **not recommended** unless e.g. you are forced to compete with strong stage lighting.

Jack Tester

● LE2

CVilization needs to recognize whether sockets are being used. As the shape of certain jack plugs cause problems with break-jack sockets (not only in CVilization), we decided to include a test page where you can check cables whenever you find that a connection is not working as expected.

Press LE2, then plug/unplug cables: White LEDs indicate functioning inputs / outputs, while green LE1 / LE2 indicate functioning CV-A / CV-B inputs. You can return to the Global Settings page by pressing any encoder.

Input Calibration

● LE3

Although the inputs are tested and calibrated to 0V at the factory, users may experience minimal deviation due to interaction with various power supplies and output impedances of CV sources. Such effects can usually be ignored in the Eurorack world, but whenever you need maximum accuracy, CVilization can measure the neutrality of your CV sources for you. DC offsets up to +/- 40 mV can be compensated for.

Press LE3 to open the calibration page. LE without a stored offset appear PASTEL GREEN, while those with stored offsets appear regular GREEN (the corresponding RE will also light up red).

Connect your “not quite 0V” source to a CVilization input, then **press and hold** the corresponding LE until all encoders flash rapidly, indicating successful calibration.

Reset via long-press on the RE: If you change CV sources and/or the power supply, the stored offsets will need to be reset, otherwise the input signal will be "corrected" with what is likely to be an inappropriate value.

A single press on any encoder will take you back to the Global Settings Page.

Clear Autosave Memory

● LE4

All parameter values in the current mode are saved after 60 seconds of inactivity, and these are recalled the next time the module is powered up. Although we have yet to encounter any problems, the ‘Autosave’ data could theoretically become corrupted. To cater for this unlikely scenario we included a function which clears the autosave memory. it is perfectly safe – this function does not delete user presets or global settings...

Long-press LE4. All encoders will flash red to indicate that the Autosave memory has been cleared. Note: Autosave can be completely disabled in the [CVZ.ini](#) – see below.

Reset Quantization

● RE4

Long-press RE4 to restore all factory quantization (scales), including any custom voltage maps you saved. All encoders will blink red to confirm the reset **WITHOUT WARNING!**

To exit any global page and boot normally, press the MODE button again.

Colour Palette Test

Before deciding on a particular Colour Palette option (see [Options in CVZ.ini](#) below), colourblind users can try out the alternatives by powering up the unit while **pressing LE3, RE3 or both:**

Wong	= LE3 only
High Contrast	= RE3 only
Vibrant	= both LE3 and RE3

To return to the standard ‘RGB’ palette, reboot without pressing any encoders.

MicroSD

The following procedures require that you gain access to CVilization's microSD slot, which is mounted on the top of the rear circuit board. This means powering down your Eurorack case and loosening CVilization with a small crosspoint screwdriver. You will also need a means of transferring files to microSD cards, of course!

Firmware Updates

You will need a file called **cvlizUpd.ebi**, which will be available via this page: u-he.com/products/cvilization/.

Tip: Only update the firmware if you are sure that this file is more recent than what you are already running!

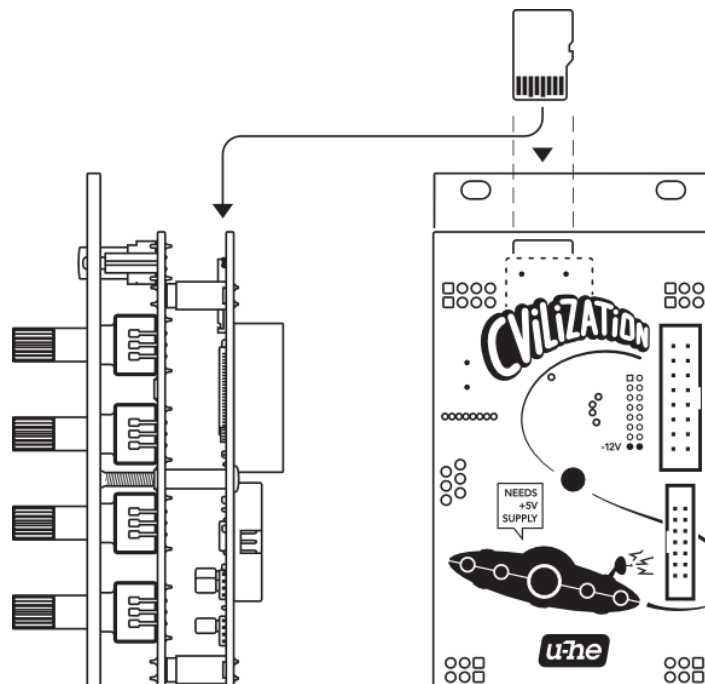

- Copy **cvlizUpd.ebi** onto the card, overwriting the previous version. With the microSD back in its slot, secure CVilization in the rack.
- Switch your Eurorack on while holding down **LE1** for 2 to 3 seconds.
- While CVilization is checking the validity of the firmware file, LE1-3 and RE1-3 should light up **GREEN**.
- If the update file was successfully loaded, **LE4** will then cycle through several colours while the firmware is being written to memory. It should then remain **GREEN** for two seconds, after which CVilization will reboot (with the familiar boot sequence) and run the new firmware.

Note: Updating the firmware can cause the default mode – the one that appears when CVilization powers up – to change. You can fix this by selecting the mode you want, then waiting 1 minute before switching off.

Options in CVZ.ini

CVZ.ini is a configuration file that resides on the microSD card. CVilization loads this file whenever it is powered up. The text will look something like this, but with fewer comments:

```
[Global]

Bus Clock Source = Gate // [Gate|MIDI]: Gate = Bus Gate, MIDI = MIDI clock via Select Bus
Bus Clock Division = 1 // use 6, 12 or 24 when using MIDI Clock
MIDI Programs = no // [on|off/yes|no/1|0]
MIDI Reset On Start = off // [on|off/yes|no/1|0]
MIDI Reset On Stop = yes // etc..

CVB Reset Mode = On Or Before Clock // [Previous Clock|On Or Before Clock]

Colour Palette = RGB // [RGB|Wong|High Contrast|Vibrant]
Count To 16 Colours = Dividers // [Dividers|Repeat 4|Segments]

Auto Save = on // [on|off]: Save current settings after 1 minute of inactivity

[Mode 1]

// Matrix rotation a.k.a. Lava Lamp mode. Only if CV-A or CV-B are otherwise unused,
CV Rotation = no // disabled

[Mode 2]

Performance Controls = Transport and Type // [Transport and Type|Step Access]
// Step Access = the LEs scroll through steps instead of switching stop / play / pause

Constant Step Voltage = 3 // 1-10 Volt. Also sets the maximum random voltage
Encoder Ticks per Volt = 12 // [12|24]: 12 = semitones only, 24 = quarter tones possible

[Mode 3]

Set Sequence Length = yes // [on|off|yes|no|1|0]
// no = allow transposition before recording!

Longest Resets All = no // [on|off|yes|no|1|0]
// yes = whenever the longest sequence restarts, it also resets the other three

Step Feedback = Length // [CV|CV and Position|Position|Length|CV and Length]
Visual Range = unipolar // [bipolar|unipolar]

Normalled Random Polarity = bipolar // [bipolar|unipolar]
Normalled Random Voltage = 5 // 1-9

// Mutation Settings
Mutagen 1 Entropy = 10 Dissociation = 0 Inversion = 0 Reversion = 0 Excursion = 1
Antigen 1 Order = 10 Association = 0 Calm = 0 Reconstruction = 0 Decursion = 1

Mutagen 2 Entropy = 7 Dissociation = 3 Inversion = 0 Reversion = 0 Excursion = 1
Antigen 2 Order = 7 Association = 3 Calm = 0 Reconstruction = 0 Decursion = 1

Mutagen 3 Entropy = 3 Dissociation = 0 Inversion = 7 Reversion = 0 Excursion = 1
Antigen 3 Order = 3 Association = 0 Calm = 7 Reconstruction = 0 Decursion = 1

Mutagen 4 Entropy = 2 Dissociation = 0 Inversion = 0 Reversion = 8 Excursion = 1
Antigen 4 Order = 2 Association = 0 Calm = 0 Reconstruction = 8 Decursion = 1

//Note that each track has a different mutation "personality" by default!
```

Sequence Length Colours

Count To 16 Colours = Repeat 4 // or Segments

This option lets you replace the colour scheme used for setting the sequence length before recording:

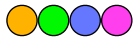

Repeat 4 = iterate orange-green-blue-magenta 4 times



Segments = orange-green-blue-magenta with decreasing brightness: orange (1-4), green (5-8), blue (9-12), magenta (13-16)

Matrix Rotation (Mode I)

CV Rotation = yes

If CV-A and/or CV-B are otherwise unused, they can be used to freely rotate the inputs and outputs: CV-A smoothly swaps the inputs while CV-B smoothly swaps the outputs.

1 volt corresponds to a complete step so that 'normality is resumed' at precisely -8, -4, 0, +4 and +8 volts. You can imagine this as CV-A scanning through the inputs while CV-B pans the outputs (quadrphonically like in Mode IV). Such rotation can create an interesting 'lava lamp' effect on the Performance Page.

If you set up just a single connection in the matrix (e.g. input 1 to output 1 at 100% gain, all others 0%) then CV-A and CV-B can be used to move this connection freely and smoothly around the matrix.

Of course if a CV input is assigned another task, that dimension of matrix rotation is no longer available. For example, if CV-A is already triggering Sample & Hold (see [Mode I - LE2: Clock / Trigger Source](#)) it can no longer rotate the inputs. However, CV-B can still rotate the outputs.

Mutation Settings (Mode III)

How the default [Mutation Type](#) behaves can be adjusted to taste. All values except Excursion and Decursion determine the probability of the respective behaviour being applied when a step is mutated.

MUTAGEN (positive mutation)

Entropy (1-10): Classic random values, one sequence step is simply randomized (standard behaviour)

Dissociation (0-10): Random increase of the interval between the mutated step and its surroundings. Dissociation is somewhat more blatant and 'targeted' than Entropy.

Inversion (0-10): The step is inverted, pivoting around the average note in the sequence. A high note becomes a low note and vice versa.

Reversion (0-10): The step is exchanged with the corresponding step of the sequence played backwards. Example: With 16 steps, 5 and 11 would be swapped.

Excursion (1-5): The maximum number of octaves jumped by random values. Used by Entropy and Dissociation only (Inversion and Reversion take fixed values).

ANTIGEN (negative mutation)

Order (1-10): Random intervals, always towards the reference note (standard behaviour)

Association (0-10): The mutated note approaches one of its two neighbours, chosen at random.

Calm (0-10): Intervals between neighbouring notes are 'calmed' by moving the current note towards the average of its two neighbours.

Reconstruction (0-10): Restore the original recorded note

Decursion (1-5) The maximum number of octaves jumped by random values. Used by Order, Association and Calm (Reconstruction takes fixed values).

Example: Entropy = 6 Dissociation = 3 Inversion = 3 Reversion = 0

Such values would mean that *Entropy* is executed for about 50% of mutations, *Dissociation* and *Inversion* for about 25%, and *Reversion* never. As *Entropy* and *Order* have a minimum weight of 1 they will occasionally happen – you can never turn these two off completely, as that would mean no mutation at all.

Expert Teamwork

Team u-he (late 2020)

- Urs Heckmann (big concepts, big code)
- Jayney Klimek (office manager)
- Howard Scarr (user guides, synth presets, grump)
- Rob Clifton-Harvey (IT admin, backend development)
- Sebastian Greger (graphic design)
- Jan Storm (framework, code)
- Alexandre Bique (all things Linux)
- Oddvar Manlig (business development)
- Viktor Weimer (support, synth presets, the voice)
- Thomas Binek (QA, bug-hunting, presets)
- Henna Gramentz (office supervision, support)
- Frank Hoffmann (framework, browser)
- Alf Klimek (rock-star vocals, studio)
- Sebastian Hübner (media, synthwave)
- David Schornsheim (more code)
- Stephan Eckes (yet more code)

Expert electrical engineering by **Tobias Münzer** & the **Tubbutec** team!

Heckmann Audio GmbH
Wilmsdorfer Str. 98-99
10629 Berlin
Germany

THE LAVA LAMP MODE

ACCIDENTALLY DESIGNED BY ONE OF THE ENGINEERS, THE LAVA LAMP MODE GOT ITS NAME FROM THE BEAUTIFULLY CHANGING COLOURS OF THE FRONT PANEL LEDS. IT DID NOT PROCESS ANY SIGNALS AT ALL, IT JUST LOOKED NICE. RUMOURS SAY THAT CIVILIZATION'S LEAD DESIGNER ORIGINALLY INSISTED ON KEEPING THIS MODE BECAUSE IT WAS SO IMMERSIVE, MODULAR MUSICIANS WOULD SIMPLY STARE AT CIVILIZATION FOR HOURS AND MAKE NO MUSIC AT ALL. FURTHER RUMORS THAT CIVILIZATION GOT ITS NAME FROM EXACTLY THIS, TO "CIVILIZE" MUSIC AND ERADICATE MODULAR SYNTHESIS WERE NEITHER CONFIRMED NOR DENIED. THE MANAGEMENT DECIDED TO DROP THAT FEATURE FROM THE MODE I DEFAULTS, BUT SOMEONE IN THE MARKETING DEPARTMENT THOUGHT IT WOULD BE A FUNNY ANECDOTE. THE WRITER OF THIS USER GUIDE DISAGREES BUT HAD NO SAY IN THE MATTER... AS USUAL!